

# Defender®

Marine Outfitter Since 1938



Look for **NEW!** and innovative products throughout the catalog and at [www.defender.com](http://www.defender.com)

Some manufacturers' pricing is uncertain at time of publication. Visit [Defender.com](http://Defender.com) for current prices.



- Anchoring & Docking..... 43-44
- ..... 51, 57-63
- Anchors & Anchor Accessories... 44-56
- Bags..... 137, 152, 158, 167, 169
- Blocks..... 71-76, 78, 84, 86, 88
- Boats, Motors & Trailer Accessories
- ..... 2-8, 18-22
- Books ..... 228
- Cabin & Galley ..... 122-139
- Canvas & Fabrics..... 176-180
- Chain, Rodes..... 44-45
- Cleats ..... 57, 63, 78
- Clothing & Accessories..... 154-158
- Deck & Cockpit.. 138, 180-187, 221
- Dinghy Accessories..... 9-17
- Docking & Fenders ..... 58-63
- Electrical..... 277-295
- Electronics ..... 231-276
- Engine & Fuel Systems ..... 23-35
- Fiberglass & Epoxy ..... 192-198
- Flooring..... 175
- Heads ..... 103-107
- Instruments..... 246-247, 249-250
- Lifejackets ..... 159-163
- Liferafts..... 169
- Lighting..... 296-309
- Maintenance..... 188-207, 219-220
- Mooring ..... 47-48
- Multifunction Displays..... 258,
- ..... 261-264, 267, 268, 271
- Navigation ..... 222-230, 257
- Navigation Lights..... 296-299
- Paint & Accessories..... 9, 208-218
- Plumbing..... 96-121
- Pumps ..... 96-102, 108, 118, 121
- Refrigeration ..... 130-133
- Rope/Cord.. 43-44, 64-66, 179-180
- Safety..... 159-174
- Sailboat Hardware ..... 67-95
- Shackles..... 46, 80-81
- Steering ..... 38-42, 251-255
- Ventilation ..... 140-151
- Watersports & Bicycles..... 152
- Windlasses ..... 52-56
- Zincs/Anodes..... 35-37

**Defender's Low Price Promise**

Defender is an authorized U.S. dealer for everything we sell. We offer new products backed by manufacturers' warranties. If you find a lower delivered price on a new product from another authorized U.S. dealer, please email us at [customerservice@defender.com](mailto:customerservice@defender.com) or call us at 800-628-8225. In most cases we will match or beat the price.





**Defender is recognized as the largest inflatable boat dealer in the World!**  
We know inflatable boats. We warehouse 12 brands of boats and engines with over 2,000 units in stock and ready for immediate delivery.

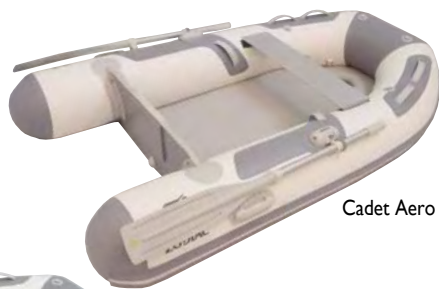

Cadet Aero

Cadet 200  
Slat RollupCadet  
Aluminum  
Floor

### Zodiac Cadet Series

The Zodiac Cadet range is available in a rollup slatted floor for stowability, an Aero floor for performance and stowability, and an aluminum floor for high performance. All models feature progressive diameter tubes for stability, and internally controlled self-bailer and standard seat and carry bag.

Cadet  
Fastroller  
FR325

High  
Pressure  
Air Keel

### Zodiac Cadet Fastroller

Equipped with Zodiac's patented Acti-V inflatable floor, the Fastroller series boasts unequalled load capacity and accurate handling thanks to anti drift fins and an inflatable V-hull design. Quick to assemble and easy to stow, the Fastroller offers comfort in navigation and provides exceptional performance.



### Zodiac Cadet RIB Alum

Light, easy to handle aluminum tenders feature large diameter tubes for stability, non-skid strips inside the hull and include an underseat bag and keel protector. Available with or without a bowlocker, you get your choice of fabric: PVC or CSM-Hypalon.



### Zodiac Cadet RIBS

Generous interior room and seating, large diameter tubes for stability, this range provides performance in an elegant package.



Made in  
France



Slat Floor

Aluminum  
Floor

Aero

Compact

### Zodiac Wave Series

Featuring welded seams and a 5 year warranty, the Zodiac Wave line is packed with value! Available in slat, aluminum and Aero floors, there is even a compact RIB with a folding transom! Visit [www.defender.com](http://www.defender.com) for specifications, availability and pricing.

#### Features:

- Fully welded seams
- Welded transom cuffs with a proprietary thermoweld-riveted transom attachment
- Welded attachments (rubstrake, d-rings, oarlock, oarlock base, etc)
- Aero models feature a high-pressure air floor [11.3 psi - vs - 8.5 psi]
- The most reliable and easiest-to-replace inflation valves in the industry

### Zodiac Parts and Accessories

Item	Model	Description	Ship	Net
451025	Z60035	Replacement carry bag for Zodiac inflatable boats (will fit most other brand boats up to 11')	4 lbs	\$114.99
453290	Z1253	Bow holdall bag for Zodiac Cadets with factory installed bow buttons	2 lbs	109.99
451016	Z2856	PVC repair kit - assorted patch colors and glue	11 lbs	44.99

#### DON'T SEE IT?

E-mail questions and inquiries to [inflatables@defender.com](mailto:inflatables@defender.com). If you don't see it, we can get it.  
Special-order parts inquiries welcome! Include the make, model, year and serial number.



The entire line of Zodiac inflatables, Deluxe RIBs, sportboats and Professional Series is available. Call 800-628-8225 option 7, fax 800-654-1616 or email [inflatables@defender.com](mailto:inflatables@defender.com) for a digital Zodiac brochure with full specifications and details on models, including those not listed here.



Bayrunner 420



### Zodiac Bayrunner

For sport cruising, the Bayrunner Series offers ample forward seating suitable for the entire family. The cockpit design features large underseat storage areas. Whether waterskiing, fishing or cruising, the Bayrunner is sure to please.



Pro Patrol 550DP

### Zodiac Defender Pro Patrol 550DP & Pro Patrol 650DP

The Defender Pro 550DP and Pro 650DP were designed to offer unparalleled safety and versatility. These multi-purpose boats include an open deck layout that provides the highest level of utility and performance. The Defender Pro DP meets the operational needs of today's discerning recreational and professional boaters while remaining budget conscious.



YL340DL-DP  
CSM Hypalon



YL420DL-F60 PVC

### Zodiac Yachtline Deluxe RIBs

Performance with style! The Yachtline RIBs are quick to get on plane with an interior designed to be comfortable with plenty of storage for gear. Features removable tubes for ease of maintenance. Visit [www.defender.com](http://www.defender.com) for color options.



Pro Cruise 550

### Zodiac Defender Pro Cruise RIBs

Comfort, performance and security are just a few of the things the Pro Cruise series offers. With many tube options and interior configurations, one is sure to meet the needs of any boater.

Pro Chase 500DP-E50



### Zodiac Defender Pro Chase RIBs

Available in numerous colors and configurations, the Zodiac Pro Chase range offers unlimited choices. Whatever your interests, this range is sure to create unforgettable outings with family and friends.

INFLATABLE BOATS • Zodiac

PHONE 800-628-8225 • FAX 800-654-1616

#### DON'T SEE IT?

E-mail questions and inquiries to [inflatables@defender.com](mailto:inflatables@defender.com). If you don't see it, we can get it. Special order parts inquiries welcome! Include the make, model, year and serial number.



**Defender® Inflatables**

Defender Inflatables are custom built with the features you want, and to our demanding specifications, to be rugged yet great looking while providing high performance. This is a safe and durable craft that not only delivers unmatched value, but also earns such confidence that we stand behind the 5-year warranty. Defender Inflatables are constructed entirely with proven fabrics from Mahler-Haku (PVC) and Achilles (Hypalon) by the most respected builder in China.



Defender RIB265 PVC

Defender RIB300

Defender RIB430

Defender 470

Defender 380

**Defender® RIBS**

Our redesigned Defender Inflatables now feature Leaffield valves and pressure relief valves for each chamber. Improved rub strake, handles and grab lines provide a sleek new look and better function, while standard pre-installed KeelGuard protects against scratches when beaching - a great value whether you choose a PVC or CSM model.

**NEW! Custom Covers for Defender RIBS**

Hot Shot Acrylic fabric provides a light weight cover that provides water, mildew and UV resistance. Features 4-ply folded seams and tie down loops (tie down sold separately) along with shock cord in the hem for a secure fit.

- Item **457355** Cover For RIB265, Gray Ship 6 lbs **Net \$164.99**
- Item **457356** Cover For RIB300, Gray Ship 6 lbs **179.99**

**Defender® First Responder Boats**

Defender First Responder and Dive boats are constructed of either Haku PVC or commercial grade Achilles T15 1670 Dtex Hypalon fabric, and feature a solid panel aluminum floor. Combined with Leaffield air and pressure relief valves, these boats are ready to work. They are a great choice for the budget-minded response agency and are available in Gray and Red fabrics. **E-mail [inflatables@defender.com](mailto:inflatables@defender.com) for municipal packages and pricing.**

INFLATABLE BOATS • AB, Defender Inflatables & KeelGuard

SHOP 24/7 AT WWW.DEFENDER.COM



FIBERGLASS MODELS  
ALSO AVAILABLE AT  
[WWW.DEFENDER.COM](http://WWW.DEFENDER.COM)



**AB Lammina AL**

Featuring a lightweight unpainted aluminum hull which provides durability and minimal maintenance, the Lammina is perfect for those with lighter capacity davits without sacrificing performance and capability. It's double layer, non-skid floor provides a stable surface for passengers, and bowlocker and keel protector is standard.



**AB Ultralight UL**

Ultra-light and spacious, the UL Series features a non-skid floor, unpainted aluminum hull, and high payload capacities at a reasonable price. Built to the same quality standards as the larger luxury models, it is a favorite among sailors due to its lightweight and low maintenance.

FOR CURRENT PRICING, SPECS, AND AVAILABILITY VISIT [WWW.DEFENDER.COM/INFLATABLES](http://WWW.DEFENDER.COM/INFLATABLES) OR EMAIL [INFLATABLES@DEFENDER.COM](mailto:INFLATABLES@DEFENDER.COM)



**MEGWARE KEELGUARD®**

**Megaware KeelGuard**

Wear and damage to your boat's keel can break down its protective gelcoat finish, allowing water to reach and destroy the fiberglass laminates. Megaware KeelGuard®, the powerful abrasion-resistant protector, prolongs the life of your boat like nothing else. Every aspect of the patented Megaware KeelGuard has been designed with boat designers and 3M® engineers. Many factors contribute to its success. A precise, abrasive-resistant blend of polymers and urethanes achieve optimal durability and pliability. A pressure-sensitive adhesive creates strength, while permanently bonding and sealing Megaware KeelGuard's contoured edges to the hull surface. Angled grooves produce hydrodynamic channels, creating air pockets and providing a slicker surface. The perfect combination of these factors makes the Megaware KeelGuard the easiest keel protector to install, and gives it unparalleled quality and dependability.

- Item **450025** 4' L x 5" W, for fiberglass RIBS to 14' Ship 3 lbs **Net \$118.95**

Colors: Hunter Green, Almond, Sand, Yellow, Charcoal, Gray, Light Gray, White, Black, Blue and Red. Please specify. Other sizes available as special order and ships direct from the manufacturer.

Item	Size	Boat Size	Ship	Net
<b>453875</b>	5' L x 5" W	15' to 16'	4 lbs	<b>\$133.95</b>
<b>453876</b>	6' L x 5" W	17' to 18'	4 lbs	<b>149.95</b>
<b>453877</b>	7' L x 5" W	19' to 20'	5 lbs	<b>165.95</b>
<b>453878</b>	8' L x 5" W	21' to 22'	6 lbs	<b>181.95</b>
<b>453879</b>	9' L x 5" W	23' to 24'	6 lbs	<b>197.95</b>
<b>453880</b>	10' L x 5" W	25' to 26'	6 lbs	<b>212.95</b>
<b>453881</b>	11' L x 5" W	27' to 28'	7 lbs	<b>228.95</b>

❖ For more detailed product specifications and our complete selection visit [www.defender.com](http://www.defender.com) or call 800-628-8225. ❖



**DEFENDER IS  
RECOGNIZED AS THE LARGEST  
INFLATABLE BOAT DEALER IN  
THE WORLD!**



## Achilles Inflatables

Achilles offers an extensive lineup of inflatable boats that stand up to their reputation for quality, reliability and performance. Featuring high quality Achilles Hypalon- CSM fabric, a smooth, simple oar system and proven inflation valves, their practicality of these inflatable boats is evident.



LT-2

### LT Series

These dinghies are compact enough to store anywhere, while capable of carrying substantial loads. They feature the same fabric and oarlock system as the larger models, and come standard with motor mount, oars and seat.



HB-310AL

### HB AL Series

Lightweight and durable, these aluminum hulled tenders feature a powder coated finish. Great boat for fuel efficiency and performance.



**#1 FOR  
VISIBILITY  
ON THE  
WATER!**

**DEFENDER  
EXCLUSIVE!**

### LSI-290E and LSI-310

Our exclusive Red LSI boats are best for high visibility on the water. Only at Defender!



LS4RU

### LSRU Series

Enjoy the convenience of a lightweight, roll-up tender that can be stored in a space just 10" high. Easy to carry, set up and store, this model has features you don't want to sacrifice, such as towing rings and rowing seat.



HB-310AX

### HB AX Series

Takes the AL to the next level with a full length deck liner and roomy bow locker for storage.



LSR-290E



LEX-88

### LEX Series

A popular choice with its painted sectional wood floor and additional standard features, this series offers a classic inflatable look and feel with improvements that keep them practical even today.



HB300FX

### HB FX Series

The folding transom on series makes the HB FX inflatable not only lightweight, but easy to transport, carry and launch.

### LSR-E Series

This popular rollup aluminum floor is easy to get in and out of the water quickly. Large tubes allow LSR-E to carry heavy loads and extra patches for adding a second seat are standard.



SPD-290E

### SPD-E Series

These boats feature three rear aluminum floorboards to withstand the brunt of abuse (the front boards are painted wood) and large diameter tubes for greater load capacity and better performance. A second seat can be added thanks to the standard extra seat patches.



HB 240 LX

### HB LX Series

With the performance of the DX series, the LX series utilizes a lightweight fiberglass hull design that modifies the deck design and removes the bow locker for a 20% weight savings



LSI-260E

### LSI-E Series

The Achilles high-pressure CSM-Hypalon AirFirm floor is the industry's toughest floor while being remarkably rigid. Loaded with features no matter which size you choose, these models are available in Gray, White and our exclusive Red!



HB 315 DX

### HB DX Series

Best combination of performance and functionality with its deep V fiberglass hull and roomy built in bow locker. The 315DX now includes a locker roomy enough to store a fuel tank, with a fuel line chase.

#### OPTIONAL BOW CUSHION FOR HB DX MODELS

Item	Description	Ship	Net
457358	For 2018 models and older	2 lbs	\$99.99
458184	For 2019 models and newer	2 lbs	159.99

#### REPLACEMENT PARTS

For replacement seats and valves see pages 12 and 14.

#### Repair Kit for Achilles CSM-Hypalon

Please specify: Blue, Gray, Pearl Gray, Red or White.

Item	Model	Ship	Net
450150	Please choose kit color	1 lbs	\$23.99

**Stringer** For Achilles floorboard set that has plastic stringers

450721	C391GY	1 lbs	19.99 each
--------	--------	-------	------------

**H-joint** For Achilles floorboard set that has plastic H-joints

450722	SC392GY	1 lbs	19.99 each
--------	---------	-------	------------

Defender carries a full line of replacement parts for Achilles inflatables. Visit us at [www.defender.com](http://www.defender.com) or e-mail [inflatables@defender.com](mailto:inflatables@defender.com) and include the year and model of your boat.

**FOR CURRENT PRICING, SPECS, AND AVAILABILITY  
VISIT [WWW.DEFENDER.COM/INFLATABLES](http://WWW.DEFENDER.COM/INFLATABLES)**

## DON'T SEE IT?

**E-mail questions and inquiries to  
[inflatables@defender.com](mailto:inflatables@defender.com).**

**If you don't see it, we can get it.**

**Special order parts  
inquiries welcome!**

**Include the make, model,  
year and serial number.**



# Defender®

## Defender RIB Packages

These rugged RIBs are custom built for Defender with commercial grade, 1670 Decitex Hypalon fabric. Multiple configurations are available which deliver safety, durability and unmatched value.



Defender RIB460



Defender RIB430 Jockey Seat



Defender RIB430 Bench Seat

PLEASE VISIT  
[WWW.DEFENDER.COM](http://WWW.DEFENDER.COM)  
FOR CURRENT SPECS, PRICING AND AVAILABILITY

**PLAN AHEAD!**  
Build Times Can  
Take 1-8 Weeks



## Achilles DX RIB Packages

Features a fiberglass hull in a lightweight, rigged package. Multiple configurations available.



HB315DX  
BF20  
Aluminum  
Console & Bench Seats

HB385-DX  
BF40  
Seat & Console  
Package



HB-315DX  
BF20D3SRT  
HBSCB  
Seat & Console  
Package



### AB VST Series

The Oceanus fiberglass sport console RIB delivers unsurpassed performance, comfort, versatility and capacity.



### AB ALX Series

The Alumina features a lightweight yet rugged aluminum hull and offers both ample storage and a spacious deck.



### AB VSX Series

The Mares feature a Deep V Fiberglass hull and molded in console and seating. Compact, lightweight and practical, they are ideal as a yacht tender.

FOR CURRENT PRICING, SPECS AND AVAILABILITY VISIT [WWW.DEFENDER.COM/INFLATABLES](http://WWW.DEFENDER.COM/INFLATABLES) OR EMAIL [INFLATABLES@DEFENDER.COM](mailto:INFLATABLES@DEFENDER.COM)





**AVAILABLE WITH HYPALON FABRIC ON AIRDECK, RIB AND HEAVY DUTY MODELS!**

With the addition of an aluminum hull RIB in your choice of PVC or Hypalon-CSM fabric, Mercury is sure to offer a boat that meets your needs. From the easily stowed dinghy models to the robust Ocean Runner and everything in between, Mercury builds reliability into every one.



**Air Deck**

Lightweight and comfortable with a roomy interior, Air Deck models make stowing a breeze and setup a snap. Available in PVC or Hypalon-CSM.



**Dynamic RIB**

This series features a laminated fiberglass hull and transom molded with vacuum injection technology for strength and stability. With a roomy interior and a lightweight design, Dynamic RIBs are available in PVC and Hypalon-CSM fabric.



**Sport**

This series maximizes portability and economy without compromising performance. Fiber-reinforced polymer floorboards with non-skid surface provide safety and stability. PVC only.



**Ocean Runner**

Stepped Fiberglass V-hull for performance, and spacious interior for your guests, Ocean Runners are engineered to handle higher HP motors. 350 and 430 models include an integrated bow locker. Available in PVC and Hypalon-CSM fabric.



**Aluminum RIB**

Mercury brings an aluminum hull RIB to the market that features an integrated bow-locker, non-skid deck, and 2 aluminum seats as standard equipment. Offered in both PVC and Hypalon-CSM fabric.



457392

Underseat storage bag



453783

Hypalon Repair Kit, Red/Black

**Mercury/Quicksilver Accessories**

Item	Model	Application	Ship	Net
454303	899775	Cover for 240 Airdeck and Sport, for 2003 and up	10 lbs	\$159.99
454304	899776	Cover for 270 Airdeck, Sport and Dynamic, for 2003 and up	10 lbs	169.99
454305	899777	Cover for 310 Airdeck and Sport, for 2003 and up	11 lbs	184.99
454306	899778	Cover for 310 Dynamic, for 2003 and up	11 lbs	189.99
454307	899779	Cover for 340 Airdeck and Sport, for 2003 and up	13 lbs	199.99
454308	879180	Cover for 380 Heavy Duty, for 2003 and up	14 lbs	224.99
454309	879182	Cover for 430 Heavy Duty, for 2003 and up	17 lbs	329.99
457392	808647	Underseat storage bag for all boats except 230 Color: Gray	1 lbs	63.99
Ⓞ 450057	885161002	PVC repair kit Gray/White	1 lbs	14.99
Ⓞ 453783	896345A01	Hypalon repair kit, Red/Black	1 lbs	19.99
Ⓞ 453784	896344A05	Hypalon repair kit, White/Gray	1 lbs	17.99

**OTHER MODELS ARE ALSO AVAILABLE.**

**PLEASE EMAIL INFLATABLES@DEFENDER.COM OR VISIT WWW.DEFENDER.COM**

**DON'T SEE IT?**

E-mail questions and inquiries to [inflatables@defender.com](mailto:inflatables@defender.com). If you don't see it, we can get it. Special order parts inquiries welcome! Include the make, model, year and serial number.

**Mercury Hand Air Pump**

A perfect hand pump for inflating air floor boats, this easy-to-use, double-action hand pump is much faster than a standard foot pump. Use as either single action (pumps when pushing) or double action (pumps on both the pull and the push). Gauge included.

Item	Model	Ship	Net
450023	889345Q01	3 lbs	\$54.99
450435	889347	Adapter kit - includes (3) adapters for Mercury inflatables 2005 and newer	1 lbs 12.99



**FOR CURRENT PRICING, SPECS, AND AVAILABILITY VISIT [WWW.DEFENDER.COM/INFLATABLES](http://WWW.DEFENDER.COM/INFLATABLES) OR EMAIL [INFLATABLES@DEFENDER.COM](mailto:INFLATABLES@DEFENDER.COM)**



Defender routinely supplies Inflatable Boat Packages to Fire Departments, Police and Sheriff's Departments, Yacht Clubs and Academic Institutions. Our extensive product offerings and in-depth knowledge enable us to work with your organization to meet your needs and your budget.

Please email inquiries or bid requests to: [inflatables@defender.com](mailto:inflatables@defender.com) or contact us at 800-628-8225.

## Emergency and Rescue Boats

**Defender is recognized as the largest inflatable boat dealer in the World!**

We know inflatable boats. We warehouse 12 brands of Boats and Engines with over 2000 units in stock and ready for immediate delivery.



TWO MODELS!

### Achilles FRB Rapid Deployment, Fire Rescue Boat

The aluminum Rollup non-skid floor mode is lightweight and inflates quickly using a foot pump or compressed air bottle. Perfect for Fire Departments or Emergency Rescue.



### Achilles SG Series Work, Dive and Emergency

Offers room and performance to fill a range of needs. Its aluminum floorboards and size enable it to carry a fully equipped team of divers while deep V air keel ensures better tracking and performance when speed is of the essence.

**MERCURY**  
Inflatable Boats



Heavy Duty

### Mercury Heavy Duty

Ideal for applications where a little more strength and space are required and is a perfect choice for diving and rescue teams. Mercury offers three PVC models with aluminum floors and four hypalon models with aluminum floors.

## Defender® First Responder Boats



Defender FRB-400

**NEW!**

### Defender FRB-400

The FRB-400 was designed for inland flood rescue operations. It features a lightweight but rigid non-skid air floor, quick drain sleeves in transom, Leaffield air and overpressure valves, reflective tape port, starboard and stern for night ops, lifeline, paddles, re-righting rope and diver's knife to name a few.



Defender 380

### Defender Aluminum Floor

Designed with the limited budget rescue agency in mind, these boats feature aluminum floors, quality construction and choice of colors and fabric. All models include wear patches on top of tubes and protective rubstrakes on keel and bottom of tubes for added durability.



RIB460

## Defender®

### Defender Rescue RIBs

These rugged RIBs are custom built for Defender with commercial grade, I670 Dectex hypalon fabric. Our team has yet to find another RIB in the 14' plus size range constructed with commercial grade hypalon fabric in this price range, and we have been looking! Other key features include a keel protector, lifting eyes, wear patches on top of the tubes and both interior and exterior grab lines. Please see rigged models on page 6. For options, pricing and availability, e-mail us at [inflatables@defender.com](mailto:inflatables@defender.com).

**ZODIAC  
MILPRO**



Grand Raid

### Zodiac MilPro

Grand Raid boats form the backbone of many small boat fleets and are unique in their full equipment definition. Grand Raid boats feature reinforced fabric, intercom valve system, a large flow self-bailer and a long shaft transom. Other models are also available.



### Evinrude Rescue Pro Pumpjet

Great choice for first responders due to shallow water capability, maneuverability and reduced risk of injury to people in the water.

### Custom Lettering Plates

Custom lettering plates are available from Defender with or without retro-reflective lettering. Available in various letter sizes with background colors to match most boats. E-mail us at [inflatables@defender.com](mailto:inflatables@defender.com) for more information, lead time and quote.



Defender offers First Responders and other professionals a wide range of products including: Boats, motors, trailers, personal safety items, PFDs, immersion suits, strobe lights, whistles, harnesses, tethers, wet suits, dry suits, rope throw bags, custom splicing, lights and more.

**FOR CURRENT PRICING, SPECS, AND AVAILABILITY VISIT  
WWW.DEFENDER.COM/INFLATABLES OR EMAIL  
INFLATABLES@DEFENDER.COM**



## Inflatable Cleaner & Protectant

### AUGUST RACE LIQUID RIB CLEANER/CONDITIONER

August Race Liquid RIB is capable of cleaning both Hypalon and PVC tubes and can truly bring your RIB back to life. When used with August Race UV Conditioner, results can last up to one year.

Item	Model	Size	Ship	Net
Ⓞ 756739	RIBTUBECLEANER	1 liter spray	3 lbs	\$34.99
Ⓞ 756740	RIBTUBEUV	1 liter spray	3 lbs	34.99



### POLYMARINE INFLATABLE BOAT CARE

Easy to use, non-silicone cleaner specifically formulated for use on all Hypalon and PVC inflatable boats. Removes dirt, white oxidation, grease, oil, petrol deposits and is biodegradable.

Item	Model	Size	Ship	Net
753806	53.98.20	Cleaner 16.9 oz trigger spray	1 lbs	\$19.99
756797	53.98.20	Cleaner 500 ml refill bottle	1 lbs	14.99



### AMAZON'S INFLATABLE BOAT CLEANER

Made for all inflatables. Cleans fast. Just spray on, wipe off. Contains silicone. Designed to clean Hypalon and PVC boat surfaces.

Item	Model	Size	Ship	Net
Ⓞ 451170	INF-850	32 oz. Spray	3 lbs	\$14.99



### 303® AEROSPACE PROTECTANT

The best protection for ANY inflatable material including Hypalon and PVC. Approved and recommended by most boat manufacturers. Restores color and luster; leaves super-repellent finish to prevent soiling and stains. One step application. Spray on, wipe COMPLETELY dry. Offers unbeatable protection and is an excellent choice for new inflatables. Please specify size.

Item	Model	Size	Ship	Net
Ⓞ 756863	30340	16 oz. spray	1 lbs	\$11.99
Ⓞ	30306	32 oz. spray	3 lbs	18.99
Ⓞ	30370	Gallon	9 lbs	49.99



### MDR INFLATABLE & DINGHY CLEANER AND UV PROTECTOR KIT

- No harmful silicone oils
- (1) 16 oz. cleaner (MDR-850), (1) 16 oz. protectant (MDR-795)
- Professional strength
- Biodegradable
- Mild enough not to harm Hypalon, PVC, vinyl or rubber
- Easily cleans away dirt, grease and grime using fresh or salt water
- Protective coating is quick drying and easy to use

Item 453262 Ship 3 lbs Net \$18.99



### FORESPAR LANOCOTE® PROP & BOTTOM FOUL RELEASE

- Suitable for inflatable boat bottoms
- Specially formulated for props and underwater running gear
- Provides protection against marine growth for up to six months
- Bio-renewable, non-toxic and biodegradable

Item	Model	Size	Ship	Net
503281	770035	16 oz.	1 lbs	\$36.99



### INFLATABLE BOAT COVERS BY TAYLOR MADE

Features 4-ply folded seams, double folded hems, strong 1" wide tie down loops to secure the cover without scratching the watercraft. There is a shock cord in the hem for a close fit. Designed for blunt bow inflatables with or without a small outboard installed. Accommodates low consoles without screens.



### HOT SHOT ACRYLIC COATED BLUNT BOW INFLATABLE BOAT COVER

A lightweight acrylic-coated polyester cover that provides excellent water, mildew and UV resistance. Good for all climates. 6.25 oz. fabric. 5 year warranty.

Specify: Black, Cranberry, Hunter Green, Medium Gray, Navy Blue, Pacific Blue or Teal

Item	Model	Size	Ship	Net
454208	73000	7'5" - 8'4" x 60"	4 lbs	\$141.99
454209	73001	8'5" - 9'4" x 60"	4 lbs	151.99
454210	73002	9'5" - 10'4" x 66"	5 lbs	172.99
454211	73003	10'5" - 11'4" x 68"	6 lbs	185.99
454212	73004	11'5" - 12'4" x 70"	7 lbs	205.99
454213	73005	12'5" - 13'4" x 74"	7 lbs	220.99
454214	73006	13'5" - 14'4" x 74"	8 lbs	225.99
454215	73007	14'5" - 15'4" x 76"	9 lbs	239.99
454216	73008	15'5" - 16'4" x 76"	9 lbs	249.99
454217	73009	16'5" - 17'4" x 80"	10 lbs	269.99
454218	73010	17'5" - 18'4" x 80"	11 lbs	284.99

Larger sizes available at [www.defender.com](http://www.defender.com)

### TAYLOR MADE BOAT COVER VENT II

- Don't let your interior suffer from mold and mildew damage
- Proper ventilation can keep boat-destroying fungi from attacking
- Installs quickly and easily with no screws or fasteners
- Exhausts air, closes the top to bottom gap and keeps water out
- Manufactured from a superior grade polycarbonate blend material for strength and UV resistance
- Will accommodate either 3/4" or 7/8" support poles
- Sold individually



Item 756287 11982 Ship 1 lbs Net \$18.99



### TAYLOR MADE BOAT COVER SUPPORT POLE

Extend the life of your boat cover by preventing water and snow from pooling on top, which could collapse your cover and damage your boat.

### STANDARD SUPPORT POLE

The Standard boat cover support pole has a non-marring tip on each end of a telescoping aluminum tube. A durable plastic knob allows for easy adjustment of the height from 36" to 64".

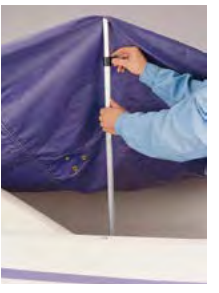

### SUPER SUPPORT POLE

Includes male canvas snap, a grommet tip and a plain end cap. Telescoping aluminum pole locks with a screw clamp. Extra wide vinyl pad reduces wear on tarp. Includes a durable plastic adjuster to set the correct height for your cover. Telescopes 36"- 64".

Item	Model	Type	Ship	Net
753219	11991	Standard	2 lbs	\$25.99
754141	11992	Super	2 lbs	29.99

## Inflatable Boat Paint

### ANTIFOULING FINISH FOR INFLATABLES

- Environmentally responsive
- Water-based, easy-to-apply ablative antifouling paint
- Uses water to efficiently transfer paint to your boat
- Durable finish, easy water clean-up and minimal odor
- For soft or hard bottom inflatables
- VOC compliant
- Unlimited dry time to launch

Item	Model	Color	Ship	Net/Quart
Ⓞ 755099	1841	Black	5 lbs	\$59.99



### AQUAGARD INFLATABLE BOTTOM PAINT

- Ablative action repels barnacles and other growth
- Use on inflatables without the use of a primer
- Scientifically formulated for superior adhesion
- Flexible coating will not crack, even when boat is deflated and rolled
- Can be used on Hypalon, vinyl or PVC boats
- Can relaunch after extended haul-out while retaining original antifouling properties
- Soap and water cleanup

Item	Model	Color	Ship	Net/Quart
Ⓞ 752430	90007	Light Gray	4 lbs	\$35.99



### MDR INFLATABLE BOAT & DINGHY BOTTOM COATING

Water-based, antifouling coating contains cuprous oxide for maximum protection against marine growth in fresh and mid-temperature range salt water. Use on most inflatable materials including Hypalon, PVC, rubber, fiberglass and wood dinghies. Easy to apply with brush or roller. Easy cleanup with water. Inflatables can be deflated and rolled without cracking bottom coating. One quart will provide two coats of protection for the average 8' - 10' boat.

Item	Model	Color	Size	Ship	Net
Ⓞ 450439	MDR-787	Black	Quart	3 lbs	\$45.99



### MDR INFLATABLE BOAT TOP COATING

Makes your inflatable look new. Water based formula is easy to apply and cleans up easily. For Hypalon, PVC or rubber inflatables. Covers 100 sq. ft.

Item	Model	Color	Size	Ship	Net
756862	MDR-783	Gray	Quart	3 lbs	\$31.99
	MDR-784	White	Quart	3 lbs	31.99



❖ For more detailed product specifications and our complete selection visit [www.defender.com](http://www.defender.com) or call 800-628-8225. ❖





## Manual Pumps

### SCOPREGA BRAVO 5 FOOT PUMP

- Compact foot pump fits most common valves
- Stainless Steel metal parts
- Reinforced coated fabric bellows
- Includes: Triple nozzle adapter, hose, closing clip and valve adaptors

Item	Model	Ship	Net
456810	6070005	2 lbs	\$18.99

### SCOPREGA BRAVO 10

- Allows you to inflate your inflatable boat to its recommended pressure with minimal effort
- Strong fiberglass, (4) anti-slip feet, crush resistant hose and universal hose with valve adapters
- Bravo 10 has a pressure indicator
- Double chamber 5L 4.4 psi, 1.6L 11.6 psi

Item	Model	Ship	Net
450566	6090010	5 lbs	\$57.99

### BUILT-IN PRESSURE GAUGE SCOPREGA BRAVO 7M & 8M

- Bravo Professional series pumps feature reinforced fabric coated bellows, all stainless steel parts and universal adapters
- Built-in pressure gauge to allow direct reading of pressure

Item	Model	Liter	Ship	Net
454219	6090017	5	3 lbs	\$35.99
454220	6090018	6.5	4 lbs	48.99

### SCOPREGA BRAVO 101 AND BRAVO 110

New generation of pumps provide high efficiency with minimal effort. Built-in pressure gauge along with kink free hose (it's on the pump body not on the handle) provide ease of use. Features faster inflation capability than other pumps on the market and durability from ABS and aluminum construction. The Bravo 101 will inflate to 27.5 PSI and the Bravo 110 to 14.5 PSI. The 110 also deflates.

Item	Model	Ship	Net
457680	6120600	6 lbs	\$54.99
457681	6120700	6 lbs	54.99

### SCOPREGA BRAVO 9 HP HIGH PRESSURE FOOT PUMP

- Double chamber pump with plug allows you switch from low to high pressure without removing the hose
- For inflating tubes and high pressure air floors
- Use with manometer to monitor pressure while inflating
- 4.4 / 14.5 psi

Item	Model	Ship	Net
454224	6090009	4 lbs	\$49.99

DEALER PRICING AVAILABLE ON BRAVO PUMPS. PLEASE CONTACT US AT COMACCOUNTS@DEFENDER.COM.

### DEFENDER FAVORITE!



## Electric & Battery Operated Inflators/Deflators

### SCOPREGA BRAVO BP AND BTP 12 ELECTRIC PUMPS

12 VDC electric pumps that will inflate to a maximum pressure of 14.5 psi. All models can inflate and deflate, come with a carry bag and adapters and automatically stop when selected pressure is reached.

- The BP12 has a dial pressure selector and puts out 160 liters per minute
- The BTP12 Manometer features the pressure selector incorporated into a manometer
- BTP models put out 450 liters per minute
- All models include a 3 m power cord with alligator clips, a 1.70 m inflation hose and can be fitted with a Ni/Mh battery kit for cordless use

Item	Model	Ship	Net
455269	6130037	5 lbs	\$124.99
455271	6130038	6 lbs	169.99

### Accessory - BK Battery Kit for BP/BTP models

This kit gives over 800 recharge cycles and has no memory effect (easily fits into carry bags included with pumps). Ni-Mh battery.

Item	Model	Ship	Net
455272	6130041	4 lbs	\$229.99

### BRAVO 12

- 12 VDC pump will inflate a 10' boat to 4.4 psi in minutes
- Pressure can be selected from 2.2 to 4.4 psi, and it shuts off when pressure is reached
- It can also deflate
- 10-14 A max amp draw

Item	Model	Ship	Net
450708	6130003	4 lbs	\$129.99

### BRAVO 800

These updated pumps feature higher reliability with brass gearing in a turbine and piston pump. Includes carry bag, 5' 6" hose, alligator clips (non-battery model) or cigarette lighter adapter charger (for battery model) and universal hose adapters. The battery model will run approximately 15 minutes on one charge.

- Large air flow: 450L / minute
- Inflates and deflates
- Adjustable pressure up to 11.6 PSI
- Power 12VDC, Draw: 13 Amp



Item	Model	Ship	Net
457581	BST800	5 lbs	\$229.99
457582	BST800BATT	11 lbs	269.99

### BRAVO 20

High efficiency, low noise pump that inflates and deflates. Built-in battery is rechargeable through cigarette plug or DC adapter. Also includes alligator clips for direct connection to a 12V battery. Automatic shutoff prevents overheating. Runs approximately 15 minutes on a charge. 125L/min, 9 amp max consumption, will inflate up to 22 PSI.

Item 457583 Model BRAVO 20 Ship 8 lbs Net \$299.99



### BRAVO OV10 120V ELECTRIC INFLATOR

- 1,000 Watt
- Will inflate to 3.6 psi
- Weighs just 1.7 kg
- Includes 1.5 m hose and universal adapters
- 1,700 Liters per minute (449.1 Gal / min)
- Dimensions: 5.9" x 6.3" x 6.7"
- Equipped with anti-sand filter
- Can also deflate
- 120 VAC / 60 Hz

Item	Model	Ship	Net
456278	6130265	5 lbs	\$124.99



## Pump Replacement Parts & Accessories All ship 1 lbs.

Hose Connector

Replacement Hose & Adapters

Manometer

Universal Pump Hose Adapter

Closing Hook

Valve Adapter for Halkey Roberts Valves

Item	Model	Description	Net
450579	R151014	Replacement hose and adapters for Bravo 1, 10 and Bravo 12 Turbo	\$14.99
451183	R151046	Replacement hose connector for Bravo 1, 2 and 10	3.99
450578	R151013	Replacement hose and adapters for Bravo 6 and 12	11.99
451186	S241220	Replacement hose connector for Bravo 7, 8 and 9	3.99
457682	R151051	Replacement hose and adapters for Bravo 101 and 110	16.99
457683	R151052	Replacement hose and adapters for Bravo OV10	19.99
457684	R151018	Replacement hose and adapters for Bravo BST12 Series	14.99
457685	R151035	Replacement hose and adapters for Bravo 20	23.99
457689	R990023	Replacement hose and adapters for Bravo BP12 Series	16.99

Item	Model	Description	Net
450590	R151054	Replacement hose and adapters for Bravo 7,8 and 9	\$14.99
450573	R151090	Manometer pressure gauge for use with Halkey Roberts valves	17.99
451185	R551091	Manometer and adapter for use with most valves	19.99
450576	R151047	Universal pump hose adapter	2.99
457679	R201020	Pair of closing hooks for Bravo 7M, 8M, 9 and 10. Holds pump in closed position for easy, safe storage	8.99
454988	718-ADJ	Scoprega valve adapter for Halkey Roberts valves. Works with old or new style Halkey Roberts valves	7.99

JUST BOUGHT A BOAT? PLANNING A MAJOR TRIP OR UPGRADE? DEFENDER'S EXPERT OUTFITTERS CAN HELP! CALL 1-(888)-490-6844 OR EMAIL US AT OUTFITTING@DEFENDER.COM TO TAKE ADVANTAGE OF OUR OUTSTANDING OUTFITTING SERVICE.





**AB REPLACEMENT OARS AND OARLOCKS**

Item	Model	Description	Ship	Net
455878	6384	Replacement oarlock, Gray or Black, sold each	1 lbs	\$24.99
456731	6293101	Telescoping oar 120-156 cm for AB or Caribe inflatables	2 lbs	22.99



**ACHILLES REPLACEMENT OARS**

Item	Model	Description	Ship	Net
456279	DC635	49" oars for 2-3 man boat, pair only	3 lbs	\$89.99
450147	DC632	58.5" oars for 4 man boat, pair only	4 lbs	104.99



**AVON STYLE REPLACEMENT JOINTED OAR**  
 • Length: 6' 3" • Stainless steel joint • Shaft diameter: 1-3/8" • Blade: 39" • Handle: 39"

Item	Model	Description	Ship	Net/ea
455705	ART 4029-194	Replaces wood jointed oars used on Avon boats, 190 cm total length, each	4 lbs	\$54.99



**DEFENDER OARS**  
 These oars work on Defender RIBS and Mercury boats with pin style oarlocks.

Item	Model	Description	Ship	Net
455628	OB012/OH009	156 cm oar, Gray, each	2 lbs	\$24.99

**DEFENDER SCREW CAPS FOR OARS**  
 Pin style oarlock screw cap keeps oars secure. Works on Defender, Achilles, Mercury, Zodiac and West Marine boats with pin style oarlocks

Item	Model	Ship	Net
456254	OS-00602	1 lbs	\$8.95



**MERCURY OARS**

Item	Model	Description	Ship	Net/ea
456510	883899 & 885159	63.125" Oar with integrated lock	2 lbs	\$44.99
453608	62-883899 & 885156	56.5" jointed oar, no oarlock	2 lbs	39.99
453627	883899 & 885159001	61.5" jointed oar, no oarlock	2 lbs	39.99

**MERCURY OAR HOLDER / PIN CAP**  
 For late model PVC Mercury inflatables. Color: Gray

Item	Model	Ship	Net
457050	8M9200339	1 lbs	\$5.99

**BRAVO OARS FOR ZODIAC**  
 63" collapsible oar is a direct replacement for Zodiac oars of the same size that utilize a clamp on oarlock system. Also work on 2013 and newer Wave 275 and 310 models

Item	Model	Description	Ship	Net/ea
450611	6301500	63" black collapsible oar, each (replaces Z6300)	2 lbs	\$21.99
455298	6301501	63" gray collapsible oar, each (replaces Z6425)	2 lbs	21.99

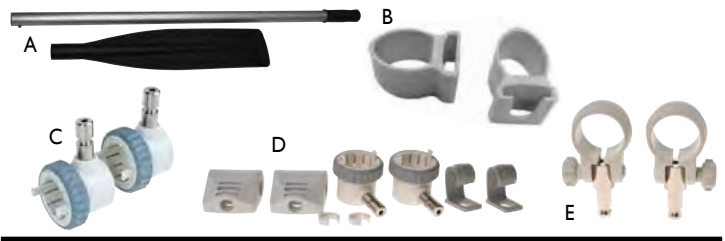

**REPLACEMENT OARS & OARLOCKS FOR ZODIAC, WAVE SERIES AND BOMBARD INFLATABLES**

Item	Model	Description	Ship	Net
A	450588	Z6300PR Pair of Bombard/Zodiac 62-1/2" oars, Black blade	4 lbs	\$79.99
B	450596	Z2815 Pair of oar clips for 1997-present Zodiac Cadets (holds bottom of oars securely to boat)	1 lbs	28.99
C	456284	Z67502 Replacement oarlocks for Zodiac Cadet Series and YL RIBS. Fits 2003 and newer models or 1997-2002 models on which the oarlock system has been upgraded. Also fits 2013 and newer Zodiac Wave Series 275/310 model	1 lbs	72.99
D	456289	Z67506 Upgrade kit for reclining oarlock system (pair) used on Zodiac/Bombard 1998-2002. This is the new system used on the 2003 and newer boats.	1 lbs	89.99
E	455216	D67067A Pair of replacement oarlocks for Zoom and Bombard Inflatables built by Zodiac; 35 mm dia. shaft	1 lbs	29.99



**CROOKED CREEK NATURAL FINISH WOOD OAR WITH COMFORT GRIP**  
 New Zealand pine. Multi-ply laminated construction. Brown epoxy blade tip.

Item	Model	Length	Ship	Net/ea	
Please Specify Length	457347	C10750	5'	3 lbs	\$36.99
	C10755	5.5'	3 lbs	40.99	
	C10760	6'	3 lbs	43.99	
	C10765	6.5'	3 lbs	46.99	
	C10770	7'	4 lbs	51.99	
	C10775	7.5'	4 lbs	56.99	
	C10780	8'	90 lbs	59.99	



**CROOKED CREEK NATURAL FINISH WOOD PADDLE**  
 New Zealand pine. Multi-ply laminated construction. Brown epoxy blade tip.

Item	Model	Length	Ship	Net/ea	
Please Specify Length	457346	C10301	3.5'	2 lbs	\$18.99
	C10302	4'	2 lbs	19.99	
	C10303	4.5'	2 lbs	20.99	
	C10304	5'	2 lbs	21.99	
	C10355	5.5'	3 lbs	25.99	
	C10360	6'	3 lbs	28.99	



**CROOKED CREEK SYNTHETIC PADDLES WITH HYBRID GRIP**  
 Anodized aluminum shaft with thick rubber sleeve. Hybrid grip supports the full palm and promotes a more natural hand and wrist motion.

Item	Model	Length	Ship	Net/ea	
Please Specify Length	457348	C11440	4'	2 lbs	\$19.99
	C11445	4.5'	2 lbs	20.99	
	C11450	5'	2 lbs	21.99	
	C11455	5.5'	2 lbs	22.99	

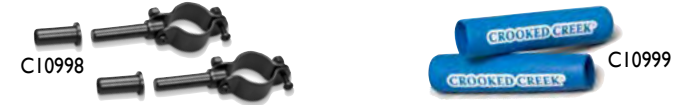

**CROOKED CREEK ACCESSORIES**

Item	Model	Description	Ship	Net
457349	C10998	Oar locks	1 lbs	\$12.99 /pair
457350	C10999	Oar grips	1 lbs	10.99 /pair

**SEA-DOG OARLOCKS & SLEEVES FOR RIGID DINGHY All Ship 1 lbs.**

Item	Model	Description	Net/pr.
<b>A. Ribbed Oarlocks: 1/2" Shank diameter x 2-1/4" length</b>			
454946	580412-1	Die cast zinc, chrome plated, 2-1/4" length	\$11.99
455884	580570-1	Cast brass, 2-1/8" length	26.99
<b>B. Ribbed with Pins Oarlocks: 1/2" Shank diameter x 2-1/4" length</b>			
454947	580413-1	Die cast zinc, chrome plated, 2-1/4" length	\$11.99
<b>C. Round Horn Oarlocks: 1/2" Shank diameter</b>			
454948	580425-1	Die cast zinc, chrome plated, 2-1/4" length	\$13.99
455885	580590-1	Cast brass, 2-1/8" length	28.99
454956	580870-1	Hot-dipped galvanized, 2" length	5.69
<b>D. Top Mount Oarlock Sockets: 1/2" Shank diameter</b>			
454949	580450-1	Die cast zinc, chrome plated, 1-3/16" D	\$8.99
455886	580600-1	Cast brass, polyethylene inserts for smooth rotation, 1-1/16" D	12.99
454957	580880-1	Hot-dipped galvanized, 1-1/16" D	5.99
<b>E. Angle Mount Oarlock Sockets: 1/2" Shank diameter</b>			
454950	580451-1	Die cast zinc, chrome plated, 4-5/8" W	\$11.99
454958	580890-1	Hot-dipped galvanized, 1-3/16" D	6.99
456308	580620-1	Cast brass, polyethylene inserts for smooth rotation, 4" W	26.99
<b>F. Side Mount Oarlock Socket: 1/2" Shank Diameter</b>			
455887	580610-1	Cast brass, polyethylene inserts for smooth rotation, 3-3/4" W	17.99
<b>G. Oarlock Sleeve</b>			
451154	580101-1	Injection molded polyethylene oar protector fits standard oars. Cushions stroke, reduces noise and prevents wear. 1-3/4" I.D. Split for easy installation.	\$14.99

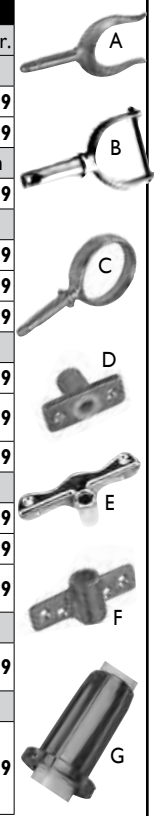



### Achilles Replacement Air Floors

Available for most models, these are factory replacement floors for your Achilles.

Item	Model	Fits Boats	Ship	Net
457690	FQL230E	LSI-230E	8 lbs	\$549.99
457691	FQL260E	LSI88, LSI260, LSI260E	8 lbs	599.99
457692	FQL290E	LSI96, LSI290, LSI290E	8 lbs	699.99
457693	FQL310E	LSI104, LSI310, LSI310E	8 lbs	789.99
457694	FQL330E	LSI112, LSI335, LSI335E	8 lbs	899.99

### Mercury Replacement Air Decks

Replacement air decks fit 2004 and newer model year air deck boats with (2) flap attachments on transom. Can also be used to convert your 2004 model year or newer Sport model to an air deck. Simply order the correct size floor, add a thrust board (sku 450022) and a double action handpump (sku 450023) or any other pump capable of inflating high pressure floors to complete your conversion!

Item	Model	Description	Ship	Net
455300	896281A06	Air floor for 240, 2004 to 2019	10 lbs	\$349.99
455301	896282A06	Air floor for 270, 2004 to 2019	12 lbs	379.99
455302	896283A06	Air floor for 310, 2004 to 2019	13 lbs	459.99
455303	896284A06	Air floor for 340, 2004 to 2019	14 lbs	462.99
450022	852875T12	Thrust board for 240 through 340, 2004 to 2019	5 lbs	24.99

### Zodiac and Wave Replacement Floors

#### Slat Floors

Replacement slat set, set of 6, fits Zodiac 240 and 260 Rollups, Wave 275 2013 and up, and West Marine 240/260RU. Available in Gray and Blue. Dimensions: 830 mm x 83 mm x 10mm

Item	Model	Color	Ship	Net
451124	Z3935	Gray	7 lbs	\$144.99
456403	Z60286	Blue	7 lbs	154.99



#### Air Floors

Factory replacement air floors for Zodiac Wave and some West Marine air floor models.

Item	Model	Fits Boats	Ship	Net
458058	Z67000	Wave 275 2013 & newer, West HP275 Series Z24020	8 lbs	\$389.00
458059	Z67001	Wave 310 2013 & newer, West HP310 Series Z24021	8 lbs	399.00

Z67000



### SailorBags Underseat Storage Bag

- Easily attaches to any inflatable's bench seat
- Large main storage compartment
- 3 Accessory pockets, cushioned seat top

Item	Color	Seat Top Dimensions	Ship	Net
456031	Navy or Gray	35" x 10"	3 lbs	\$52.99

### Defender Bench Seat Cushion

- Installs using Velcro® straps,
- Material: White UV resistant vinyl
- 2" thick
- 1 year warranty

Item	Model	Ship	Net
456798	809773-2	3 lbs	\$79.99
457160	16DEFINF33C	2 lbs	54.99

Dimensions: 40" L x 8.5" W  
Dimensions: 33.5" L x 8.5" W



### Defender RIB Bow Cushion

- Turn your bow locker into an extra seat
- Fits RIBs with similar bow dimensions

- Color: White
- Includes snaps to install

Item	Model	Ship	Net
457358	16DEFBOWSM	2 lbs	\$99.99
457359	17DEFBOWXSM	2 lbs	99.99



### Seat Attachment Points for Inflatables

Seat patches for inflatables can be used to replace existing webbing type seat patches that seats hook into, or can be used to add an extra bench seat. You will need 2 patches in the fabric type to match your boat and the proper glue. If the proper width seat is not available, Item #457902 (seat brackets) can be affixed to any size marine grade plywood, cut down to size to create your own seat.

Item	Model	Description	Ship	Net
455766	SW001	Gray PVC seat patch, each	1 lbs	\$8.99
455767	SW00602	Gray hypalon seat patch, each	1 lbs	11.99
455297	896452	White hypalon seat patch, each	1 lbs	14.99

### Replacement/Extra Seats for Achilles Inflatables Wood Seats

Item	Model	Description	Ship	Net
453293	WST96LG	31.5" L, Gray painted wood for LSI96/290, LSI104, LSR96, LSR104, SPD96, 2008 and newer LSR290, LSR310, SPD290, SPD310 or SPD104	5 lbs	\$124.99
450136	WST112LG	Painted wood for LSI112, SPD112, LSI335, HB280DX, HB315DX (channel connection attachment included)	8 lbs	149.99

#### Aluminum Seats

457512	AST310	for LSI/LSR/SPD 290/96/104	4 lbs	\$124.99
457515	AST350	for HB350DX/LX	6 lbs	124.99
457511	AST330	for SPD112/330E/335	5 lbs	149.99

#### Accessories

450646	EA003	Plastic seat channel hardware for wood & aluminum seats – 2 are needed for one seat (replaces seat brackets on the Achilles seat)	1 lbs	14.99
--------	-------	-----------------------------------------------------------------------------------------------------------------------------------	-------	-------

### Replacement Seats for Defender RIBs

- Made of Gray fiberglass • Includes brackets
- Fits both hypalon and PVC version RIBs
- Seats will also work on other models with the same webbing style seat attachment points such as Mercury Inflatables. Confirm size before ordering for other models.

Item	Model	Fits RIB model	Dimensions	Ship	Net
455630	SE03401	265	80 cm x 20 cm	5 lbs	\$44.99
455629	SE03301	300*	85 cm x 20 cm	6 lbs	49.99

\*Also Mercury 270-340SP & AD 2009 & newer



### Replacement/Extra Seats for Mercury Inflatables

All seats include brackets to attach to tubes. Other seats available by special order.

Item	Model	Description	Ship	Net
450053	880960T	Light Gray wood seat for 270, 300, 310, 330 and 340 Sport and Rollup models 2003-2008	8 lbs	\$54.99
453770	811307T04	Dark Gray wood seat for 270, 300, 310, 330 and 340 Airdeck, models 2003-2008	7 lbs	54.99
456786	880960T03	Gray fiberglass coated seat for 270, 300, 310 and 340 Airdecks and Sport 2009 and newer	7 lbs	59.99
457902	8113131	Mercury replacement seat attaching brackets, pair	1 lbs	13.99

### Replacement/Extra Seats For Zodiac & Wave Series

More replacement seats available online at [www.defender.com](http://www.defender.com)

Item	Model	Description	Ship	Net
450999	Z1113	Wood seat for Zodiac Cadet 240-310, 2004 and older	5 lbs	\$89.99
303504	Z60518	Wood seat for Zodiac Cadet 240-310, 2005-2015	4 lbs	89.99
303503	Z60519	Wood seat for Zodiac Cadet 340, 2005-2015, 2009-2015 Zodiac C285, FR325 and C360FR, Wave 275 and 310	7 lbs	109.99
457008	NS1523	Aluminum seat for Zodiac Cadet C200/230 2015 and newer White/Gray models only	4 lbs	69.99
457009	NS1524	Aluminum seat for Zodiac Cadet C270/310 2015 and newer White/Gray models only	4 lbs	74.99
457010	NS1525	Aluminum seat for Zodiac Cadet C350 2015 and newer White/Gray models only	5 lbs	79.99



## Inflatable Boat Adhesives



35.44.35      35.44.16      35.44.34      35.44.10

### Polymarine Adhesives

Choose 1 part tubes to replace the original glue found in your repair kit, for temporary repairs and light duty use. Select 2 part formulas for more permanent repairs, such as air leaks and D-ring attachment.

Item	Model	Description	Ship	Net
Ⓞ 455363	35.44.15	2 part glue for Hypalon fabric: 250 ml	1 lbs	\$33.99
Ⓞ 455364	35.44.35	2 part glue for PVC fabric: 250 ml tin with 10 ml bottle of 107 curing agent	1 lbs	33.99
Ⓞ 455365	35.44.16	2 part glue for Hypalon fabric: 1 Liter tin with 40 ml bottle of 107 curing agent	2 lbs	75.99
Ⓞ 455366	35.44.36	2 part glue for PVC fabric: Liter	3 lbs	75.99
Ⓞ 455362	35.44.34	1 part tube glue for PVC fabric: 70 ml	1 lbs	15.99
Ⓞ 455361	35.44.10	1 part tube glue for Hypalon fabric: 70 ml	1 lbs	15.99

### Shore Inflatable Adhesive

Use to adhere D-rings to tubes or to attach registration sticker holders to CSM hypalon boats. This one-part cement can be used safely and securely on all ABS, CSM, fiberglass and Kevlar boats. Use Toluol to prepare surfaces to be glued.

Item	Model	Size	Ship	Net
Ⓞ 450076	510	Half pint	1 lbs	\$17.99

### Inland Marine Inflatable Boat Sealant

Formulated for use on all CSM (Hypalon) and PVC boats to seal or slow pinhole leaks in inflatable tubes. Does not flake off and is not affected by heat or cold. Includes instructions. For inflatable boats up to 12'.

Item	Model	Size	Ship	Net
453955	IBSK	32 oz.	3 lbs	\$48.95

### Aquaseal® Marine Repair Adhesive

EASIEST DIY FIELD REPAIR FOR INFLATABLE BOATS

Unique urethane adhesive and sealant for permanent, flexible and indestructible waterproof repairs of inflatable boats, neoprene rubber products, wetsuits, drysuits or foul weather gear. Simply apply several thin layers over the hole or abraded area and allow to dry. Permanently seals the fabric.

Item	Model	Size	Ship	Net
Ⓞ 450431	10110	3/4 oz. tube	1 lbs	\$7.99

## Inflatable Repair Products

### Whitewater Designs Inflatable Repair Kits

HYPALON REPAIR KITS

Includes both adhesive and solvent in resealable cans. Large kit includes a 6" x 50" piece of tube material and equal amount of floor material, sandpaper, roller and instructions. You get all of this for less than the price of a meter of most OEM fabric alone! Small kits feature less fabric for smaller jobs, at 6" x 12.5", and do not include floor fabric.

Item	Model	Color	Size	Ship	Net
Ⓞ 457097	582HLG	Light Gray	6" x 12.5"	1 lbs	\$34.99
Ⓞ 457097	582HW	White	6" x 12.5"	1 lbs	34.99
Ⓞ 457097	582HR	Red	6" x 12.5"	1 lbs	34.99
Ⓞ 457096	580HG	Gray and Black	6" x 50"	3 lbs	64.99
Ⓞ 457096	580HR	Red and Black	6" x 50"	3 lbs	64.99

### VINYL REPAIR KITS

Same as above, BUT include solvent only. You must purchase PVC glue separately. (See above, Polymarine Adhesives)

Item	Model	Color	Size	Ship	Net
Ⓞ 457098	587PG-NOGLUE	Gray	6" x 15"	1 lbs	\$14.99
Ⓞ 457098	587RG-NOGLUE	Red	6" x 15"	1 lbs	14.99
Ⓞ 456281	585PG-NOGLUE	Gray	6" x 60"	2 lbs	29.99

### Orca Hypalon Fabric

Hypalon fabric in 57" x 6.5" strips. Includes more product than the average repair kit at a reasonable price! Use with any 2 part Hypalon glue for simple repairs to your Hypalon inflatable.

Please Specify: Arctic Gray, Neptune Gray, Red, Black, Off White or Ice White.

Item 753326	Ship 1 lbs	Net \$29.99
-------------	------------	-------------

### Inflatable Boat PVC Repair Fabric

- Material for patching/repairing PVC inflatable boats
- Material: 1100 Decitex PVC
- Glue not included

Item	Size	Color	Ship	Net
456301	6.5" x 54"	Dark Gray	1 lbs	\$19.99
456300	12" x 54"	Light Gray	1 lbs	35.99

## Inflatable Boat Paint

THIS CATALOG ONLY DISPLAYS SOME OF WHAT DEFENDER CARRIES. CALL 800-628-8225 OR GO TO WWW.DEFENDER.COM FOR AN EXPANDED SELECTION.

### Polymarine Superflex PVC Paint

A fully flexible paint formulated for renovating PVC fabric. Restores the look of fabric. Smooth satin finish will not crack or flake off. Apply with a brush or gloss roller; touch dry in one hour. Not intended to seal or repair. 1 can covers 2.5 square meters. Not for use on Hypalon. Please Specify: Black, Blue, Dark Blue, Gray, Orange, Red, White or Yellow.

Item	Size	Ship	Net
Ⓞ 455368	500 ml	2 lbs	\$79.99



### Polymarine Flexithane Hypalon Paint

A fully flexible paint formulated for Hypalon fabric. Restores the look of fabric and prevents rubstrake and moldings from powdering. Apply with a brush or gloss roller; touch dry in 30 minutes. This paint can also be sprayed; 2 coats are recommended. 1 can covers 3 square meters. NOT FOR USE ON PVC INFLATABLES. Please Specify: Black, White, Gray, Orange, Red or Blue.

Item	Size	Ship	Net
Ⓞ 455367	500 ml	2 lbs	\$79.99



### ECO-Tuff Renew

ECO-Tuff Renew is a one part waterborne acrylic vinyl product for boats that need to be freshened up. Simply paint the reconstructive ECO-Tuff over your existing material to restore, renew and protect your inflatable. ECO-Tuff adds a layer of strong acrylic vinyl that bonds directly with the surface of your boat.

- Covers exposed and worn fabric
- Protects from harmful UV damage
- Renews your old deteriorating inflatable into a new looking boat
- Adds years of pleasure to your investment
- Simpler restoration backed by years of testing

Item	Model	Color	Size	Ship	Net
Ⓞ 455384	150-20	Gray Semi-Gloss	Quart	4 lbs	\$109.99
Ⓞ 455385	150-30	Black Gloss	Quart	4 lbs	109.99
Ⓞ 455386	150-40	White Semi-Gloss	Quart	4 lbs	109.99
Ⓞ 455387	150-50	Red Gloss	Quart	4 lbs	124.99
Ⓞ 455388	150-60	Orange Gloss	Quart	4 lbs	124.99

Note: Tuff-Coat, a Xylene solvent based product that is the industry standard for inflatable repair and restoration, is still the answer for projects that are more challenging.

### Tuff-Coat

Tuff-Coat is a two part inflatable boat paint that is applied directly to worn PVC or Hypalon fabric. Before you throw out that worn out inflatable boat, try Tuff-Coat to renew, protect and restore your dinghy back to life.

- Works great on PVC or Hypalon Inflatable boats
- Simple 3 step application:
  - Thoroughly clean the surface
  - Apply the base coat
  - Apply the top coat color
- Make a tired, worn and leaking dinghy look as good as new
- Great results for a fraction of what it would cost to buy a new inflatable boat
- Restore virtually any kind of damage that your inflatable boat may have suffered

Item	Model	Color	Size	Ship	Net
Ⓞ 455377	200-20	Gray Semi Gloss Kit	Quart	10 lbs	\$149.99
Ⓞ 455378	200-30	Black Gloss Kit	Quart	10 lbs	159.99
Ⓞ 455379	200-40	White Semi Gloss Kit	Quart	10 lbs	159.99
Ⓞ 455380	200-50	Red Gloss Kit	Quart	10 lbs	169.99
Ⓞ 455381	200-60	Orange Gloss Kit	Quart	10 lbs	169.99
Ⓞ 455389	100-10	Base Coat Only	Quart	5 lbs	93.99

Please Note: Two part system - Topcoat and Basecoat (1 quart of each). If restoring a boat larger than 12', a second can of base coat is needed. Visit our website www.defender.com for gallon kits, or call us at (800) 628-8225 for more information.

❖ For more detailed product specifications and our complete selection visit [www.defender.com](http://www.defender.com) or call 800-628-8225. ❖

## Ladders & Steps for Inflatables



### ARMSTRONG RIB TELESCOPING BOARDING LADDER

• Side mount, select mounting hardware • Color Black or Gray/ tube diameter • Material: 304 Stainless steel, soft mounting hardware and rubber stand-offs

Item	Model	# Steps	Tube Diameter	Ship	Net
002073	RL3-37N-LG	3	21" - 24"	24 lbs	\$586.99
	RL3-37N-SM	3	16" - 20"	24 lbs	586.99
002074	RL4-48N-LG	4	21" - 24"	27 lbs	689.99

RL4-48N-LG



### DEFENDER 3-STEP FOLDING LADDER FOR INFLATABLES

• Constructed of aluminum tubing and corrosion-resistant hardware  
• Secures to the inflatable using a strap or line under the wood/ aluminum floor, by installing a D-ring in the floor of a RIB or with an eye bolt installed in the transom

Item	Model	Description	Ship	Net
455210	2311-3	3-step with handle	3 lbs	\$98.99

### DEFENDER 3-STEP TELESCOPING LADDER FOR INFLATABLES

• Stainless steel tubing with corrosion-resistant hardware  
• Folds compactly and telescopes for easy boarding  
Closed dim.: 32 cm x 27 cm Open dim.: 70 cm x 27 cm

Item	Model	Ship	Net
455200	7258	7 lbs	\$174.99



### ST. CROIX FOLDING LADDER FOR INFLATABLES

• Fully polished, 1" tubular stainless steel construction  
• Lanyard and snap hook attach to an eyebolt in your transom  
• Length extended for use: 38-1/2"  
• Overall width: 13-1/2"  
• Fold dimensions: 20-1/2" L x 13-1/2" W x 6-1/2" D

Item	Model	Ship	Net
451115	103H	9 lbs	\$274.99

### C-LEVEL SEA STEPS®

• A series of soft steps that cradle your feet while getting back aboard  
• Made of 4" cargo-type webbing  
• Each comes with 5' of 5/16" line to attach to winches or cleats and a grab handle to steady your climb  
• One step model is simple to use with inflatables and pontoon boats  
• 2 and 3 step models can be used with larger yachts and sailboats

Item	Model	Steps	Length	Ship	Net
450555	8832	1	37"	1 lbs	\$39.99
450556	8833	2	52"	2 lbs	49.99
450557	8855	3	67"	2 lbs	59.99

### C-LEVEL STEP-UP™

• Rigid step, covered with poly-webbing so it won't scratch your boat  
• Comes complete with two adjustable 4' lengths of rope  
• Hangs from your stanchions, boarding gate, or slotted toe rail  
• Rests against the side of your boat

Item	Model	Step Surface	Ship	Net
451174	8975	14" x 4"	2 lbs	\$54.99

## Air Valves



Item	Model	Description	Net
455914	V00504	Avon/Leaflet C7 valve	\$19.99
450468	690NSBV	Halkey Roberts valve, new style	19.99
456876	38547.01	Valve tool for all Halkey Roberts valves	13.99
454988	718-ADJ	Valve adaptor fitting for Halkey Roberts valves	7.99
450460	C342GY	Replacement air valve for Achilles inflatables	21.99
457585	C344	O-ring for Achilles valves, 5-pack	19.99
457586	C349GY	Replacement cap only for Achilles valves, 3-pack	14.99
457587	C3421	Valve flapper for Achilles, Dynous and Nissan	16.99
450466	Z2846/Z2847	Replacement plastic air valve for Zodiac Cadet series and most Bombard boats - also can be used on OMC, West Marine and Genmar boats	19.99
456488	Z60216	Valve cap and ring for Zodiac recessed valve; Gray	23.99
456550	Z60052	Valve cap and ring for Zodiac recessed valve; Black	23.99
457302	Z60055	Zodiac semi-recessed valve insert, White pin, pair	36.99
456037	Z67080	Zodiac semi-recessed valve insert, Green pin, pair	39.99
457106	ZVALVETool	Valve tool for Zodiac recessed valve	29.99
455274	A102800	Replacement air valve will work on Bombard Typhoon and Zoom models with push pin in center	14.99
456524	V100	AB Push button replacement valve with Red pin	31.99
456525	V105	Valve tool for AB valves with Red pin	12.99
453791	62-856646A1	Replacement valve for Mercury 200RU and 240RU	18.99
455180	879184A01	Replacement valve for Mercury Dynamic/Ocean Runner	17.99

## D-Rings & Tie Downs

Available in both Hypalon-CSM and PVC, all D-rings are constructed of stainless steel. The larger the apron, the more holding power provided. Use appropriate adhesives found on page 13.



### DELUXE HYPALON TIE-DOWNS

Item	Model	Description	Color	Ship	Net
STRONG 1"	110SS	Stainless steel D-ring - Single strap - 4.5" apron	Light Gray or Dark Gray	1 lbs	\$10.99
450472	110SS				
STRONGER 2"	130SS	Stainless steel D-ring - Double strap - 6.5" apron	Black or Gray	1 lbs	15.99
450473	130SS				
STRONGEST 2"	151SS	Stainless steel D-ring - Double strap - 10" x 8.5" triangle apron	Gray only	1 lbs	29.99
450475	151SS				

### PVC TIE-DOWNS

Item	Model	Description	Color	Ship	Net
1"	320SSV	Stainless steel D-ring - 4.5" apron	Gray only	1 lbs	\$4.99
450476	320SSV				
2"	130SSV	Stainless steel D-ring - 6.5" apron	Gray Only	1 lbs	16.99
455538	130SSV				
2"	151SSV	Stainless steel D-ring - double strap - 10" x 8.5" triangle apron	Gray Only	1 lbs	29.99
455539	151SSV				
Vinyl tie-down 1.5"	340SSV	SS D-ring - 6.5" apron	Gray only	1 lbs	6.99
450477	340SSV				

## Handles

### STRAP HANDLES

Add a heavy duty handle to your inflatable boat. Measures 4.5" x 12" with a 1.5" strap. Available with Gray pads only.

Item	Model	Fabric Type	Ship	Net
450478	410	Hypalon (CSM)	1 lbs	\$15.99
450479	415	Vinyl	1 lbs	11.99

### MOLDED HANDLES

Add this molded grip to your inflatable for a secure grasp while under way. Use appropriate glue for your inflatable.

Item	Model	Description	Ship	Net
451173	C422GY	For Hypalon (CSM) boats; Gray	1 lbs	\$27.99
455264	414	For PVC boats; Black	1 lbs	9.99

## Drain Plugs

### 7/8" DRAIN PLUG UPGRADE

This add-on drain valve insert allows you to remove your standard 7/8" flip-up style bailer plug, without water gushing in. The insert features a rubber flapper which prevents water from flowing in when you remove the bailer plug. Simply stick it into the outboard side of the thru-transom drain tube to reduce water flow back into the cockpit.

Item	455211	6263	Ship 1 lbs	Net \$6.99
------	--------	------	------------	------------

### SEA-DOG DRAIN PLUG

For transom installation, baitwells, ice chests, tanks, etc. This drain plug was designed with a molded-in recess in the base, trapping sealant, providing a more watertight seal. 1" with gasket. UV resistant injection molded nylon construction. Fits many RIBs and small boats.

Item	454150	520010-1	Ship 1 lbs	Net \$3.49
------	--------	----------	------------	------------



### DRAIN PLUGS All ship 1 lbs

Item	Model/Description	Net
457906	6018-C Flip-up style, 1-3/8" dia., pair	\$25.99
450456	Flip-up style drain plug - fits any transom requiring 7/8" plug, pair	27.99
458180	6021 Zodiac, Mercury, Force 4 25 mm inner hull drain plug, pair	9.99
457600	C441C Self-bailer drain valve flapper for Achilles, pair	9.99
450098	62-830222A05 Complete assembly for Mercury	14.99
453795	Z61083 Zodiac slide bailer complete kit	59.99
457695	Z60501 Slide bailer diaphragm only; for 2002 and newer, 5-pack	27.99
457903	Z2221 Bailer plug for Cadet and West Marine without slide bailer. Works on many Zodiac models with Black plug. Pair	25.99

### NUOVA RADE ADJUSTABLE FLIP-UP DRAIN/BAILER PLUG

Flip-up style expandable plug for a transom drain. Rubber sleeve expands in drain for secure fit. Steel nut allows adjusting the expansion for a secure fit. Diameter: 22 mm, Black plastic and rubber with steel adjuster. Fits most boats that require a 7/8" drain plug including Avon, Caribe and some Zodiac RIBS.

Item	456599	45309	Ship 1 lbs	Net \$18.99 each
------	--------	-------	------------	------------------

### FORESPAR REPLACEMENT GARBOARD DRAIN TUBE WITH PLUG

• For thicker transoms • White Marelon • Cutout: 1-1/2"  
• Includes 3/4" Drain Marelon plug • Use Teflon tape or putty on threads  
Specify Size: 1-7/16 " to 2-1/2" or 2-1/2" to 3-1/4"

Item	503795	Ship 1 lbs	Net \$20.99 each
------	--------	------------	------------------





### Weaver Snap Davits

Stainless steel davits can be operated easily with one hand and mounted to a swim platform or transom for quick, easy, secure storage. Weaver Snap Davit kits include (2) glue-on pads for the dingy and two mounting fittings. Add a Quick Kit to enable removal of davit heads from your swim platform. You will also need the recommended stand off brackets, glue-on standoff pads and a glue kit specific to your inflatable to properly secure your dinghy. A transom arc

is recommended for heavier dinghies that carry a motor. Simply substitute the rear pad with this, which installs on your transom. To ensure proper fit of your arc, please e-mail [inflatables@defender.com](mailto:inflatables@defender.com) to obtain a worksheet that must be completed prior to purchase.

Item	Model	Description	Ship	Net
451100	RBD100	GRAY Snap davits for swimboard mount, Gray	9 lbs	\$374.99
450490	RBD100	BLACK Snap davits for swimboard mount, Black	9 lbs	374.99
450491	RBD150	Snap davits for transom mount, Gray	9 lbs	374.99
450492	QUICKKIT	Plates with hardware for removal of swimboard davit heads	3 lbs	103.99
450493	2001KIT	Glue kit for Hypalon/CSM inflatable dinghy	2 lbs	57.99
450494	3001KIT	Glue kit for PVC inflatable dinghy	2 lbs	57.99
450495	2001	2 part glue (8 ounces) for Hypalon/CSM fabric	1 lbs	35.99
450496	3001	2 part glue (8 ounces) for PVC material	1 lbs	35.99
450497	RP301	Rubber stand-off pad (each), 4" D, Black or Gray	1 lbs	20.99
450498	SO12	12" Stand-off brackets (per pair)	2 lbs	81.99
450499	SO18	18" Stand-off brackets (per pair)	3 lbs	89.99
450500	SO24	24" Stand-off brackets (per pair)	4 lbs	96.99
450501	SO30	30" Stand-off brackets (per pair)	4 lbs	105.99
450502	SO36	36" Stand-off brackets (per pair)	5 lbs	114.99
455614	SOA-12/18	12"-18" Adjustable stand-off brackets (per pair)	3 lbs	116.99
455615	SOA-18/24	18"-24" Adjustable stand-off brackets (per pair)	3 lbs	124.99
455616	SOA-24/30	24"-30" Adjustable stand-off brackets (per pair)	4 lbs	132.99
455617	SOA-30/36	30"-36" Adjustable stand-off brackets (per pair)	5 lbs	141.99
455618	SOA-36/42	36"-42" Adjustable stand-off brackets (per pair)	5 lbs	149.99

Davits for hard shelled dinghies available at [www.defender.com](http://www.defender.com)

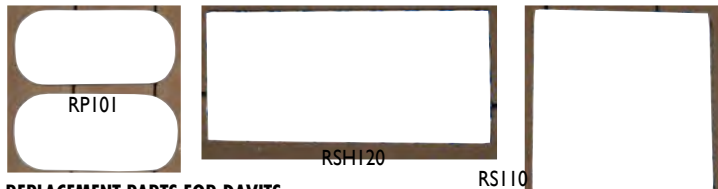

#### REPLACEMENT PARTS FOR DAVITS

Item	Model	Description	Ship	Net
450503	RP101	Replacement/extra rubber pads for inflatable (pair), Black or Gray	3 lbs	\$126.99
450504	RSH120	Stainless steel yokes for RP101 (pair)	2 lbs	65.99
450505	RS110	Davit heads for inflatable (pair)	3 lbs	203.99
450506	DHS	Davit heads for hard shelled dinghy (pair)	6 lbs	223.99
450514	HDHS	Replacement heavy-duty davit heads, 10' - 12' dinghies	7 lbs	283.99

### Weaver Transom Mount ARC

Designed for inflatables with 16" - 17" tubes that require a little more stability. Attaches to the transom and clips to the davit work on your swim platform. ARC #1 will only work on boats with transoms that are up to 0" to 4" below the tubes. Other sizes available. Please e-mail [inflatables@defender.com](mailto:inflatables@defender.com) for a worksheet that must be filled out to determine if there is an ARC right for you.

Item	Model	Ship	Net
451066	ARC #1	10 lbs	\$249.99



### Weaver Leaver™

Weaver Leaver is designed for use with Weaver Snap Davits. It allows your outboard to remain upright while your inflatable is in the vertical position. Made of rugged stainless steel and manufactured to accommodate outboards that are mounted to pivot either to the port or starboard. Handles outboards up to 85 lbs. There are two models of the Weaver Leaver, each designed for different inflatable models. It is important to obtain an order/pre-planning form to make sure that you obtain the proper model. Transom must not be more than 1-1/2" thick to work with Weaver Leaver. Please e-mail us at [inflatables@defender.com](mailto:inflatables@defender.com) for a worksheet to fill out in order to ensure the correct model is ordered for your application.

Item	Model/Description	Ship	Net
453277	LEAVER transom 4" from top	26 lbs	\$622.99
453279	LEAVER 3 for transom deeper than 4"	26 lbs	635.99

Worksheet required



### Weaver Universal Dinghy Chocks

The perfect solution for hard bottom inflatable boats. Set of (4) stainless steel chocks with fixed or swivel pads, 6" high. Purchase with a Chock Lock system to allow you to remove the chocks when not in use.

Item	Model	Pad Size	Ship	Net
450529	C1000	3.5" x 3.5" fixed	12 lbs	\$455.99
450530	C1204	3.5" x 3.5" swivel	13 lbs	602.99
455794	C1207	3.5" x 7" swivel	13 lbs	703.99
451106	C1000R	3.5" x 3.5" fixed	20 lbs	\$766.99
451107	C1204R	3.5" x 3.5" swivel	21 lbs	914.99
455795	C1207R	3.5" x 7" swivel	21 lbs	1014.99

#### REMOVABLE CHOCKS WITH CHOCKLOCK SYSTEM

### Registration Products

#### BERNARD IDENTI-LABELS™ VESSEL STICK-ON REGISTRATION NUMBER PLATES

##### For Fiberglass or Metal Hulls

- 4" H x 24" L, Pressure-sensitive White vinyl label plates are for fiberglass or metal hulls
- Provides a high contrast surface for your Bernard Pressure Sensitive Alphanumerics

Item	Model	Color	Ship	Net/Pair
455623	RL-2400	White	1 lbs	\$9.99

Letters Sold Separately

##### For Wood Hulls

- (2) 4" H x 24" L, Rigid plastic plates can be attached to wood hulls with screws
- (2) Plates can easily be removed at refinishing time

Item	Model	Color	Ship	Net
455621	RP-2400	Black or White	1 lbs	\$14.99

#### MDR INFLATABLE BOAT NUMBERING KITS

Includes a set of stencils with entire alphabet and numbers 0-9, vinyl paint with brush-in-cap and instructions. Non-toxic, water based.

Item	Model	Color	Ship	Net
450444	MDR-782B	Black	1 lbs	\$14.99
450445	MDR-782W	White	1 lbs	14.99

#### STATE REGISTRATION STICKER HOLDERS

Durable material can be adhered to any inflatable boat. Simply use the correct adhesive, PVC or CSM (not included) and apply in the appropriate location next to your numbers.

Item	Model	Description	Ship	Net/Pair
453772	REGPOCK	3" x 3" Gray Holder	1 lbs	\$19.99
453773	FLREG	3" x 4" Gray Holder	1 lbs	19.99

#### CUSTOM BOAT REGISTRATION PLATES

Getting custom, one-piece registration number plates for your boat is as easy as:

1. Purchase your personal pre-paid code package directly from Defender (one package is good for a Port and Starboard set) and appropriate glue
  2. Redeem your pre-paid code online at [www.boatnumberplate.com](http://www.boatnumberplate.com)
- Inside each pre-paid code package is a user name and password which you enter online
  - For PVC and Hypalon inflatable boats, you supply your registration number and background color choice
  - (7) colors to choose from: Gray, White, Red, Blue, Yellow, Orange or Tan
  - Specify either PVC or Hypalon boat material
  - Boat number plate approximate dimensions: 3.5" x 21"



Item	Description	Ship	Net
456213	Inflatable boats and ribs (PVC or Hypalon Glue sold separately)	1 lbs	\$34.99
456212	Rigid hull boats (self-adhesive backing)	1 lbs	19.99

#### AMERICAN FLAG SET

2.5" x 4" American flag set.

- Glue sold separately
- Sold as a pair, includes (1) Port flag and (1) Starboard flag

Item	Model	Description	Ship	Net
457919	AFS-PVC	for PVC fabrics	1 lbs	\$10.99
457920	AFS-HYP	for Hypalon fabrics	1 lbs	10.99



**St. Croix Davits**

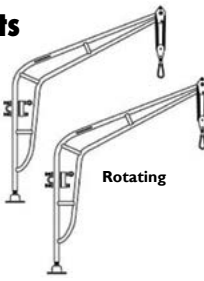

St. Croix has named Defender Industries the exclusive source for these high quality, "made in USA," stainless steel davit systems. **Commercial Account Pricing available to qualified buyers: 800-262-8727.**

Rotating davits are designed to be permanently mounted and swing out of the way and are ideal for stern rail or swim platform mounting on power or sailboats. Removable davits feature slide out shoes mounted permanently to the gunnel or swim platform.

**• St. Croix Rotating Davits Kits • Defender Exclusive!**

- Ideal for sail and power boats
- Rotating davits incorporate a fixed upper block welded as a structural component of the upper arm to multiply davit strength and prevent twisted lines
- When not in use, the davits rotate or fold together to clear the stern of your boat
- Davit arm height: 60"
- Lifting ratio: 9:1
- Ball and socket dimensions: 3"x 3"



Item	Model	Weight Rating	Tubing Diameter	Ship	Net
D 450483	400	350 lbs	1"	90 lbs	\$1734.99
D 450182	488	488 lbs	1-1/4"	90 lbs	2564.99

**Rotating Davit Accessories**

Item	Model	Description	Ship	Net
D 450452	401	(2) Swim platform mounts	59 lbs	\$974.99
456730	4017	(2) Compression plates for swim platform mounts	20 lbs	414.99
456614	415	(2) Transom handles	4 lbs	184.99

**• St. Croix Removable Davits Kits • Defender Exclusive!**



- Remove in seconds when not in use
- Lifting ratio: 9:1
- Lifting line required for 350: 5/16"
- Lifting line required for 500: 3/8"

Item	Model	Weight Rating	Tubing Diameter	Davit Arm Reach	Mounting Shoe Dims	Ship	Net
456032	350	350 lbs.	1-1/4"	40"	7-1/8" x 4-5/8"	32 lbs	\$1999.99
D 454604	SC550	550 lbs.	1-1/2"	52"	11" x 5"	90 lbs	2889.99
D 457300	SC650	650 lbs	1-1/2"	52"	11" x 5"	90 lbs	3499.99

**Removable Davit Accessories**

Item	Model	Description	Application	Ship	Net
	210	(2) 6" SS Removable risers	350	16 lbs	\$714.99
456612	213	(2) 12" SS Removable risers	350	20 lbs	799.99
	318	(2) 18" SS Removable risers	350	30 lbs	1184.99
456613	512	(2) 12" SS Removable risers	550	37 lbs	1374.99
456729	214	(2) Compression plates	350	9 lbs	329.99
	514	(2) Compression plates	550	14 lbs	624.99

**St. Croix Little Crane**

The removable crane will lift heavy loads with ease. The fixed upper pulley prevents twisted lifting lines, while the lower pulley has an integral snap hook for easy attachment to outboards, groceries, sail bags, dive gear or any other type of load.

- Crane arms rotates 270°
- 5' mast height
- Comes complete (including 5/16" line) for deck, rail and bulkhead mounting
- Stainless steel



Item	Model	Lifting capacity	Arm Reach	Included Line	Ship	Net
	SC17500	175 lbs	30"	5/16" x 75'	28 lbs	\$699.99
457301	SC17510	135 lbs	40"	5/16" x 75'	29 lbs	799.99

**Kingston D-352 Removable Davit Set**

**Dinghy Davits - Versatile mounting ability so they can fit all power and sailboats.**

- Made of stainless steel that is electro-polished, providing a bright, maintenance-free finish
- Clean design styling makes them blend in with the stern railing
- Includes all lines and blocks
- Boom arms are reversible for either extra height or long extension



Item	Model	Description	Load capacity	Ship	Net/Pair
456789	D-352	Complete davits kit	350 lbs per pair	58 lbs	\$1454.99
451044	ML-1	Motor lift kit fits 7/8" and 1" railings	100 lbs	2 lbs	114.99

**Forespar Nova Davit™ Set**

- Versatile mounting designs assure a perfect fit with an offshore strength standard
- High standard finish
- The neat folding feature stows the davit system flush with your boat's stern
- Fits 1" diameter rails that are 23" - 32" high
- 45" reach



Item	Model	Description	Load Capacity	Ship	M.A.P.
D 451192	153302	Nova davit complete kit	350 lbs per pair	90 lbs	\$1851.20
400755	153447*	1-1/4" Rail kit: includes 4 pieces: (2) 1-1/4" rail mount brackets and (2) 1-1/4" stabilizer arm brackets		3 lbs	203.99

\* Note: Using this kit reduces load to 250 lbs

**Forespar QUIK Davit™ Kit for Inflatable Dinghies**

- Designed for inflatable dinghies up to 11' in length and 175 lbs
- Stable solution for securing inflatable boat to swim step
- Fits most popular inflatable dinghies (hard and soft bottomed)
- Loading and unloading people and gear is easier and safer
- Solid stainless steel and UV resistant composite construction
- Fully compatible with other snap davit systems



**Kit Includes:** (2) Davit heads, (2) RIB pads, (2) stainless steel yokes, (2) Yoke pins, (1) Adhesive it, (8 sets) fasteners

Item	Model	Ship	Net
456404	153470	8 lbs	\$377.99

**Forespar QUIK Davit Fast Mount Kit**

- Designed to allow retrofit if Forespar or Weaver Davits are already installed
- Fully compatible with Weaver davit heads and dinghy pads (not to be used with Weaver RS150)
- Mounts to your swim platform for quick, easy removal and storage
- Solid stainless steel construction
- Comes with all mounting hardware plus fast pins with lanyards



Item	Model	Ship	Net
456770	153477	3 lbs	\$94.99

**Dollies**

**Garelick Boat Transom Dolly**

- Clamps securely to transom of dinghies or inflatables
- Corrosion resistant materials
- 250 lbs load limit
- Transom bracket: 7.25" W x 4.25" H



Item	Model	Ship	Net
100449	71050	10 lbs	\$79.99

**Launching Wheels for Inflatable Boats**

Stainless steel wheels easily install on almost any inflatable for simple transporting to the water. Wheels swivel up when not in use, swivel down when needed. Instructions included.

- 1-3/8" x 1-3/8" square tubing • 5/8" axle
- 4 Bolt pattern: 2-1/8" x 4-1/4"
- Swivel and lock up and down
- All stainless steel mounting hardware is included: (8) bolts, (8) nuts and (8) washers



Item	Model	Wheel size	Weight limit	Ship	Net
455213	7085	3-1/2" x 8"	440 lbs	15 lbs	\$219.99/pair
455304	7085C	3" x 4"	220 lbs	11 lbs	194.99/pair



### C-Level Dinghy-Lift™

Makes dinghy maintenance an easy task and offers great security when cruising in out-of-the-way waters. Fits on virtually all conventional inflatables up to 14 ft. with tubes less than 21". Three attachment points, adjustable cargo-type straps and hoisting ring make lifting easy. Dinghy can be easily swung around and dropped on deck for storage. Strong enough to lift RIBs up to 450 lbs!



Item	Model	Description	SVL	Ship	Net
450551	8835	Universal model - single point no inside lifting eyes	350	3 lbs	\$88.99
450552	8895-XL3	Dinghy lift - single point - 3 inside lifting eyes	450	2 lbs	91.99
450553	8856	Dinghy lift for 2-arm davits - 4 inside lifting eyes	400	2 lbs	112.99
450554	8852-XL4	Dinghy lift - single point - 4 inside lifting eyes	450	3 lbs	116.99

### C-Level Davit Lifting Slings

Lifting slings for boats that are stored on davits. 2 slings required for two-arm davit systems. May also be used for single point lifting systems or for lifting with a halyard (single point systems require that the 2 rings be connected by a length of line with an eye tied in the middle as a lift point). May be used for 3-point lift systems to a single point. Features 3800 lbs test strength, 1" UV resistant webbing, stainless steel quick-release snap shackles and O-ring. Offers a safe working load of 1000 lbs per pr.



Item	Model	Description	Ship	Net
450558	9123	Lifting strap for inflatables (13")	1 lbs	\$74.99
450559	9142	Lifting strap for inflatables (17")	1 lbs	75.99
450560	9089	Lifting strap for inflatables (21")	1 lbs	76.99

### Wichard Dinghy Slings

Forged stainless steel hardware with 1-3/4" mil spec parachute harness webbing for strength and safety. This sling is fully adjustable on the spot, including fore and aft center of gravity pick up point adjustment which allows for additional weight of outboard engine and gas tanks.



Item	Model	SWL	Ship	Net
453260	SP300	3-leg 2,000 lbs	3 lbs	\$256.99
450650	SP400	4-leg 2,000 lbs	4 lbs	327.99

### C-Level Towing Bridles

Allows for more stable towing than with a single line. Stainless steel towing ring and snap hooks included. Bright Yellow float prevents bridle from sinking and fouling props. Red nylon webbing. Both models feature 3,800 lbs test strength. Designed to tow inflatables or tenders (without motors) with 2 towing eyes up to 14' behind a sailing vessel. For more stable towing, use 3-point towing bridle which is designed for inflatables or tenders with 2 towing eyes AND a bow eye.

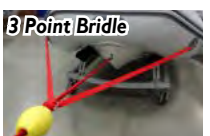

Item	Model	Points	Ship	Net
457394	8845	3	6 lbs	\$84.99
450701	8843	2	1 lbs	59.99

### Dinghy Tow Bridle and Painter

- 24', includes Stainless steel snap hooks and ring
- 5,000 lb tensile strength
- Novabraid 1/2" floating MFP double braided rope



Item	Model	Ship	Net
456280	28974	3 lbs	\$124.99

### New England Rope Dinghy Tow Rope

A brightly colored, durable, spliceable tow line that is naturally buoyant in salt water for improved visibility. **Benefits:** Double braided rope of nylon over polypropylene that is torque free and non-hocking. Braided design is easily spliced and easy to handle. Retains strength when wet or dry. **Applications:** Dinghy tow rope, rescue line, dinghy painter, throw line, etc. **Color:** Yellow with Blue tracer

Item	Model	Dia.	Tensile lbs	Ship/100 ft	Net/Ft
450784	2381-12	3/8"	2,900	4 lbs	\$0.92
450785	2383-14	7/16"	5,050	5 lbs	1.12

### Samson MFP Floatline

Double braid with a multifilament polypropylene cover and floating core **Applications:** Accessory products, halters/headgear, dinghy tow lines, floating mooring lines, etc. **Color:** Yellow with Red fleck

Item	Size	Size mm	Tensile lbs	Weight lbs/100'	Ship	Net/Ft
013053	3/8"	9	3,200	2.7 lbs	1 lbs	\$0.54
013054	1/2"	12	5,200	4.5 lbs	1 lbs	0.84
013055	5/8"	16	7,400	8.0 lbs	1 lbs	1.49

### LubriMatic® Trailer Wheel Bearing Under Grease

Provides excellent corrosion protection under severe conditions for wheel bearings (including disc brake wheel bearings), swivel hinges, pins, winches and anchor chain reels.

Item	Model	Size	Ship	Net
302549	11402	14 oz.	1 lbs	\$7.99

### Novabraid PV-12 Polyester Replacement Grab Line

- For inflatable boats
- Gray with Navy tracer

Item	Model	Size	Tensile Strength	Ship	Net
457051	63544	7/16"	7,350 lbs	1 lbs	\$1.39
	63547	1/2"	9,350 lbs	1 lbs	1.79

### C.E. Smith Lighted Trailer Post Guide with LED Lights

- Select upright height, with 2" PVC tube, notched to prevent twisting
- Designed for trailer frames up to 3" W x 4-1/4" H
- Sold in pa

Item	Model	Upright Height	Ship	Net
101480	27740	40"	18 lbs	\$97.99
101481	27760	60"	26 lbs	121.99



### Fulton Boat Guides for Trailers

- Boat guides help you visually guide your boat onto your trailer
- High-strength super gripper mounting brackets attach firmly above and below the trailer frame

- Easy bolt-on mounting fits trailer frames up to 3" W x 5" H
- Non-marring and adjustable to provide optimum fit to any hull design

Item	Model	Material	Height	Ship	Net
101318	GB44 0101	Marine grade PVC	44"	14 lbs	\$104.99
101319	GB150 0100	Marine grade PVC	50"	15 lbs	109.99
101320	BGR20 0101	Z-Max 600 finish steel	20"	16 lbs	112.99

PVC

### Fulton Bearing Protectors-Pair

- Add grease through an easily accessible grease fitting
- Keeps water and dirt out of trailer hubs and bearings

Item	Model	Hub Dia.	Ship	Net
100986	BPC198 0604	1.980"	1 lbs	\$13.99



### Attwood Angled Transom Saver

- Unique angle adjustment from 0° - 36° with 12° increments
- Innovative design will fit any trailer • Made of zinc-plated steel
- Heavy-duty rubber extrusions prevent scratching on the lower unit

Item	Model	Size	Ship	Net
101202	460-ADJ	Adjustable from 30" to 60"	11 lbs	\$104.99



### m-wedge™ Outboard Motor Support

- Requires 3-ram trim/tilt systems
- Manual or hydraulic jack plates, regular or long shaft motors

Item	Model	Applications	Ship	Net
101372	M-YM123-RP	Mercury, Yamaha, Honda and Evinrude/Johnson	2 lbs	\$39.99



### m-wedge Universal Outboard Motor Support

- Requires single ram type power tilt system • Snaps over main tilt rod

Item	Model	Applications	Ship	Net
101373	M-YU123-RP	Mercury, Yamaha, Honda, Suzuki, Evinrude and Johnson outboards	1 lbs	\$39.99



### m-wedge Outboard Motor Centering Clips

- Keeps outboard engine (1997 and newer) straight during trailering
- Snaps over hydraulic steering cylinder rods; sold as a pair

Item	Model	Applications	Ship	Net/pr.
101374	M-YC123-RP	Outboard motor (must have dual/hydraulic steering)	1 lbs	\$19.99



### Fulton Trailer Bunk Replacement Carpet

- Marine grade carpeting allows the do-it-yourselfer to replace carpet on bunk trailers
- Protects your boat investment by reducing scratching to your hull
- Color: Black

Item	Model	Size	Ship	Net
101321	CR8008	8" x 144"	1 lbs	\$21.99
101322	CR8012	12" x 144"	1 lbs	27.99



### C.E. Smith Trailer Replacement Bunk Carpet

- Dimensions: 11" x 144"
- Less chance of boat surface damage

Item	Model	Color	Ship	Net
101446	11330	Black	1 lbs	\$24.99
101447	11372	Charcoal	2 lbs	\$26.99



### Fulton Hi-Mount Spare Tire Carrier

- Fits all trailer tongues up to 3" W x 4" H • For both 4 and 5 lug wheels
- Heavy duty steel plate construction with powder coat finish
- Zinc-plated to resist corrosion

Item	Model	Description	Ship	Net
100795	STC1000101	Hi-mount tire carrier	7 lbs	\$38.99



### C.E. Smith TPR Ribbed Trailer Wobble Roller Kit

- Kit includes (4) 5" diameter x 3" wide Yellow ribbed rubber rollers
- Rollers fit 1-1/8" or 3/4" shaft using included delrin bushings

Item	Model	Description	Ship	Net
101499	29310	Wobble roller kit	6 lbs	\$55.99



### Taco Trailer Glyde Slicks

- For all boats including: aluminum, fiberglass and wood
- Launch and load your boat with ease • Hulls glide over the slick strips • Easily installed on carpeted or bare bunks
- Evenly distribute the weight of the boat • Includes stainless steel screws, instructions

Item	Model	Description	Size	Ship	Net
002097	P05-06W	Molded	2' L x 1-5/8" W - 7/16" Thick	2 lbs	\$30.99
002098	P06-06W	Premium molded	2' L x 1-1/2" W - 7/16" Thick	3 lbs	36.99



## Trailer Jacks

### FULTON F2 TRAILER JACK\*

- Maintenance free • Sealed, lubricated one-piece gearbox
  - Corrosion-resistant coatings cover internal and external components
- | Item   | Model      | Capacity lbs    | Ship   | Net      |
|--------|------------|-----------------|--------|----------|
| 101061 | 1413020134 | Twin track 1600 | 23 lbs | \$192.99 |
| 101066 | 1413040134 | Wide track 1600 | 23 lbs | 192.99   |

### FULTON XLT SWING-AWAY TRAILER JACK

- Travel: 12" • Mount: Bolt-on, steel construction
  - Premium Sharkskin™ finish for optimum corrosion resistance
- | Item   | Model  | Wheel     | Capacity lbs | Ship   | Net      |
|--------|--------|-----------|--------------|--------|----------|
| 101076 | 141133 | 8" Single | 1500         | 21 lbs | \$167.99 |

### FULTON BOLT-ON SWING-AWAY TRAILER JACK

- Travel: 12" • Steel construction, Z-Max 600 finish
- | Item   | Model      | Wheel   | Capacity lbs | Ship   | Net      |
|--------|------------|---------|--------------|--------|----------|
| 101290 | XPD15L0101 | 6" Dual | 1500         | 21 lbs | \$138.99 |

### FULTON HEAVY DUTY BOLT-ON FIXED MOUNT TRAILER JACK

- Travel: 28" • Flat footplate base: 3.8" x 7.5"
  - Steel construction, Z-Max 600 finish
- | Item   | Model      | Capacity lbs | Ship   | Net      |
|--------|------------|--------------|--------|----------|
| 101291 | HD25000101 | 2500         | 24 lbs | \$103.99 |

### FULTON BOLT-ON SWING-AWAY TRAILER JACK

- Travel: 10" • Steel construction, Z-Max 600 finish
- | Item   | Model     | Wheel     | Capacity lbs | Ship   | Net      |
|--------|-----------|-----------|--------------|--------|----------|
| 101293 | XP15 0101 | 8" Single | 1500         | 19 lbs | \$122.99 |

### FULTON BOLT-THRU SWIVEL MOUNT TRAILER JACK

- Travel: 10" • Steel construction, Z-Max 600 finish
- | Item   | Model     | Wheel     | Capacity lbs | Ship   | Net     |
|--------|-----------|-----------|--------------|--------|---------|
| 101292 | XP10 0101 | 6" Single | 1200         | 17 lbs | \$82.99 |

### FULTON BOLT-ON TRAILER JACK

- 600 hour salt spray rating per ASTM B117 standard
  - Retaining ring swivel • Mounting hardware included
- | Item   | Model      | Wheel     | Capacity lbs | Ship   | Net     |
|--------|------------|-----------|--------------|--------|---------|
| 100778 | TJ12000101 | 6" Single | 1200         | 14 lbs | \$64.99 |

### PRO SERIES RETAINING RING BOLT-ON SWIVEL MOUNT TRAILER JACK

- Travel: 10" • Steel construction, clear zinc finish • One-year warranty
- | Item   | Model      | Wheel     | Capacity lbs | Ship   | Net     |
|--------|------------|-----------|--------------|--------|---------|
| 101289 | EJ10000101 | 6" Single | 1000         | 15 lbs | \$50.99 |

\*Lifetime limited warranty on F2 series only.  
All other Fulton jacks have a 5-year warranty.



Limited Lifetime Warranty!

## Trailer Winches & Accessories



Item	Model	Speed	Capacity	Handle Length	Gear Ratio	20' Strap Included	Ship	Net
------	-------	-------	----------	---------------	------------	--------------------	------	-----

F2 MODELS - Lifetime limited warranty								
101305	FW16000101	Single	1600 lbs	6 & 7"	4.1:1	Yes	10 lbs	\$104.99
101306	FW20000101	Single	2000 lbs	6, 7, 8, & 9"	5.1:1	Yes	14 lbs	125.99
101307	FW32000101	Dual	3200 lbs	6, 7, 8, & 9"	5.1:1	Yes	17 lbs	169.99

XLT MODELS - Five-year warranty								
101379	142311	Single	1500 lbs	8"	4.1:1	Yes	7 lbs	\$87.99
101380	142314	Single	1800 lbs	10"	5.1:1	Yes	12 lbs	107.99

MANUAL MODELS - Five-year warranty								
101378	142100	Single	900 lbs	7"	3.1:1	No	5 lbs	\$44.99
	142101	Single	1100 lbs	7"	4.1:1	No	7 lbs	49.99
Please Specify Model	142102	Single	1100 lbs	7"	4.1:1	Yes	9 lbs	59.99
	142200	Single	1500 lbs	8"	4.1:1	No	7 lbs	59.99
	142300	Single	1800 lbs	10"	5.1:1	No	9 lbs	81.99
	142305	Single	1800 lbs	10"	5.1:1	Yes	10 lbs	93.99
101381	142400	Dual	2000 lbs	10"	4.1:1 & 9.8:1	No	14 lbs	126.99
101382	142416	Dual	2600 lbs	10"	5.1:1 & 12.2:1	Yes	18 lbs	137.99

### WINCH ACCESSORIES

Item	Model	Description	Ship	Net
101383	501202	Strap w/hook, 2" x 20', Black	2 lbs	\$14.99
101384	501208	Strap w/hook and loop, 2" x 12'	2 lbs	17.99
001901	WC325 0100	Galvanized cable with hook, 3/16" x 25'	3 lbs	19.99
001904	WS20HD0600	Heavy duty strap, 2" x 20', Yellow	3 lbs	20.99

## Tail Lights, Light Bar & Light Kits



### WESBAR WATERPROOF LOW PROFILE TAIL LIGHTS

Item	Model	Size	Description	For Trailers	Ship	Net
202117	403076	3" x 8"	12 VDC, Right curbside, Red	Over 80"	1 lbs	\$11.99
202118	403026	3" x 8"	12 VDC, Left roadside, Red	Over 80"	1 lbs	12.99
202130	407540	3" x 8"	12 VDC, Kit*	Over 80"	4 lbs	91.99

\* (2) Tail lights, 25' and 4' wiring harness cables with molded plugs and license plate bracket

### WESBAR SUBMERSIBLE TAIL LIGHT KIT

- 25' Wire harness • (2) pre-wired tail lights
  - 25' and 4' wiring harness cables with molded plugs • License plate bracket
- | Item   | Model   | Description         | For Trailers | Ship  | Net     |
|--------|---------|---------------------|--------------|-------|---------|
| 202133 | 2527511 | 12 VDC, Submersible | Under 80"    | 3 lbs | \$33.99 |

### WESBAR WATERPROOF 3x8 LOW PROFILE TAIL LIGHT KIT

- (2) Tail lights
  - (2) Sealed Amber surface-mount clearance / side marker lights with reflex lens
  - 25' and 4' wiring harness cables with molded plugs
  - License plate bracket
- | Item   | Model        | Ship  | Net     |
|--------|--------------|-------|---------|
| 202119 | Model 007509 | 4 lbs | \$53.99 |

### WESBAR SUBMERSIBLE 4x6 LOW PROFILE TAIL LIGHT KIT

- (2) Tail lights
  - (2) Amber clearance / side marker lights with reflex lens
  - 20' and 4' wiring harness cables with molded plugs
  - License plate bracket
- | Item   | Model        | Ship  | Net     |
|--------|--------------|-------|---------|
| 202122 | Model 407515 | 3 lbs | \$42.99 |

### WESBAR WATERPROOF ID LIGHT BAR

- White base with (3) Red light modules • Dimensions: 14-1/2" W x 1-1/8" H x 1" D
- | Item   | Model  | Description                               | For Trailers | Ship   | Net     |
|--------|--------|-------------------------------------------|--------------|--------|---------|
| 202136 | 203315 | 12 VDC, sealed polycarbonate lens/housing | Over 80"     | 11 lbs | \$14.99 |

## Tie Downs



### SUNCOR RATCHET TIE DOWN STRAPS

Item	Model	Description	Ship	Net
608394	S0201-0525	1" x 5' with harness clips	1 lbs	\$41.99
	S0201-1025	1" x 10' with harness clips	1 lbs	44.99
	S0201-2025	1" x 20' with harness clips	2 lbs	57.99

### STAR BRITE TIE DOWNS WITH ALL STAINLESS STEEL RATCHET

Item	Model	Description	Ship	Net
300111	60167	12', (2) coated "S" hooks, 1" nylon webbing	2 lbs	\$26.99
100750	60168	16' adjustable, 1" nylon webbing	1 lbs	24.99

### FULTON GUNWALE MAX GRIP RATCHET TIE DOWN (1 per pack)

- Vinyl coated J-hooks protect boat's finish • Provides super strong holding power
- | Item   | Model   | Size     | Load Capacity | Break Strength | Finish          | Ship  | Net     |
|--------|---------|----------|---------------|----------------|-----------------|-------|---------|
| 002024 | 2060866 | 2" x 10' | 333 lbs       | 1000 lbs       | Stainless Steel | 3 lbs | \$47.99 |
| 002028 | 2061266 | 2" x 10' | 833 lbs       | 2500 lbs       | Zinc            | 3 lbs | 30.99   |
| 002025 | 2060966 | 2" x 13' | 400 lbs       | 1200 lbs       | Stainless Steel | 3 lbs | 49.99   |
| 002029 | 2061366 | 2" x 13' | 833 lbs       | 2500 lbs       | Zinc            | 3 lbs | 29.99   |

### FULTON CAMBUCKLE TRAILER TIE DOWNS (2 per pack)

- Bow: Vinyl coated S-hooks • Transom: SureLok locks in place to eliminate slippage
- | Item   | Model   | Size     | Type    | Load Capacity | Break Strength | Finish          | Ship  | Net     |
|--------|---------|----------|---------|---------------|----------------|-----------------|-------|---------|
| 002016 | 2060166 | 1" x 36" | Bow     | 300 lbs       | 900 lbs        | Stainless Steel | 2 lbs | \$19.99 |
| 002017 | 2060066 | 1" x 36" | Bow     | 400 lbs       | 1200 lbs       | Zinc            | 2 lbs | 13.99   |
| 002020 | 2060466 | 2" x 24" | Transom | 833 lbs       | 2500 lbs       | Zinc            | 4 lbs | 28.99   |
| 002021 | 2060766 | 2" x 48" | Transom | 833 lbs       | 2500 lbs       | Zinc            | 2 lbs | 14.99   |

\*Not a 2 pack—single tie down

## Hitch Accessories

### FULTON ZINC FINISHED REPLACEMENT TRAILER COUPLER

- Offers a quick-lock ball clamp assembly with trigger-action release
- | Item   | Model      | Ball Size | Width | Capacity | Ship  | Net     |
|--------|------------|-----------|-------|----------|-------|---------|
| 100761 | 11200 0101 | 1-7/8"    | 2"    | 2000 lbs | 3 lbs | \$24.99 |
| 100762 | 11300 0101 | 1-7/8"    | 3"    | 2000 lbs | 3 lbs | 24.99   |
| 100763 | 22300 0101 | 2"        | 3"    | 3500 lbs | 5 lbs | 27.99   |

### TOW READY ZINC PLATED TRAILER HITCH PIN & CLIP

Item	Model	Fits	Ship	Net
101283	63240	5/8" dia., 2" square receivers, groove style	1 lbs	\$5.99

### BULLDOG BENT PIN TRAILER RECEIVER LOCK

- Chrome finish • Pin diameter: 5/8"
- | Item   | Model  | Fits                           | Ship  | Net     |
|--------|--------|--------------------------------|-------|---------|
| 002004 | 580400 | 1-1/4" and 2" Square receivers | 1 lbs | \$15.99 |

### REESE UNIVERSAL TRAILER COUPLER LOCK

- Locking mechanism resists picking/prying • Includes 2 keys (keyed alike)
  - Resists rust and corrosion • Easy-to-install and remove
- | Item   | Model | Fits                                 | Ship  | Net     |
|--------|-------|--------------------------------------|-------|---------|
| 003318 | 72783 | Most 1-7/8", 2" and 2-5/16" couplers | 2 lbs | \$20.99 |





# HONDA MARINE

For over 50 years, Honda Marine has been perfecting the design of the four-stroke engine. Honda has always known the important that four strokes reduce noise, smoke less and use less fuel as compared to two-stroke models. All Honda outboards meet rigorous CARB (California Air Resources Board) outboard standards, earning the top level 3-Star rating for Ultra Low Emissions.

  
**Honda Marine**  
*Premier Dealership*

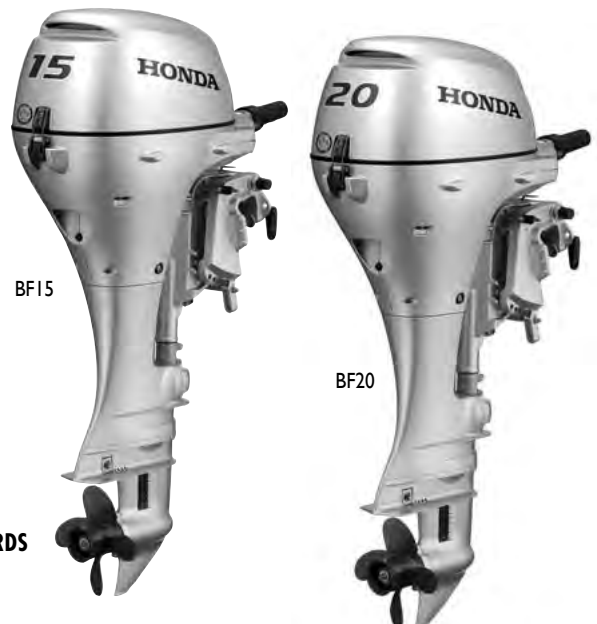
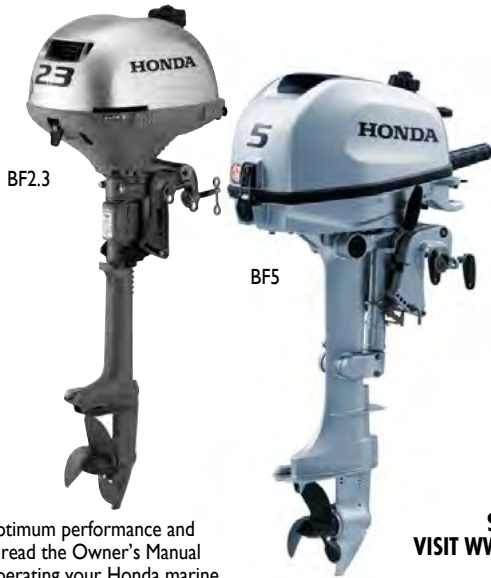

**FOR CURRENT PRICING,  
SPECS AND AVAILABILITY,  
VISIT [WWW.DEFENDER.COM/OUTBOARDS](http://WWW.DEFENDER.COM/OUTBOARDS)  
OR EMAIL  
[OUTBOARDS@DEFENDER.COM](mailto:OUTBOARDS@DEFENDER.COM)**

For optimum performance and safety, read the Owner's Manual before operating your Honda marine product. Always wear a personal flotation device while boating!



58130-ZV0-841ZB

58130-ZVD-601ZA

58130-ZW9-V12ZA

### HONDA REPLACEMENT PROPELLERS

Item	Model	Material	Blades	Engine	Dia' x Pitch"	Ship	Net
303032	58130-ZV0-841ZB	Plastic	3	BF2 & BF2.3	7-1/4x4-3/4	1 lbs	\$36.99
303031	58130-ZVD-601ZA	Aluminum	3	BF5A	7-7/8x6-5/8	2 lbs	94.99
306010	58130-ZVD-003ZA	Aluminum	3	BF4A, BF5D, BF6A	7-7/8x7-1/2	4 lbs	94.99
302727	58130-ZW9-V12ZA	Aluminum	4	BF8 - BF20D	9-1/4x8	3 lbs	89.99
302758	58130-ZW9-V32ZA	Aluminum	4	BF8 - BF20	9-1/4x10 Power Thrust	3 lbs	91.99

### IMPELLER KITS Includes: Impeller, gasket and o-ring

Item	Model	Engine	Ship	Net
303602	06192-ZV1-C00	BF5A	1 lbs	\$19.99
303603	06192-881-C00	BF8A	1 lbs	24.99
303604	06192-ZW9-000	BF8D/9.9D	1 lbs	20.99
303605	06192-ZW9-A30	BF15D/20D	1 lbs	20.99
303606	06192-ZV7-000	BF25/30	1 lbs	22.99

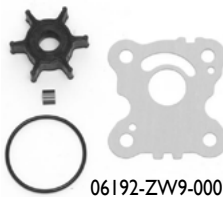

06192-ZW9-000

### HONDA SHEAR PIN

Item	Model	Engine	Ship	Net
300114	58131-ZV0-000	2 HP	1 lbs	\$2.69
302994	58131-ZV1-010	BF5A and BF8A	1 lbs	2.99

Flush Kit  
06190-ZV1-860



### ANODE REPLACEMENT

Item	Model	Engine	Ship	Net
302746	41106-935-812	BF 2-15 HP	1 lbs	\$6.99

### FLUSH KIT Allows fresh water flushing with a garden hose

Item	Model	Engine	Ship	Net
303479	06190-ZV1-860	BF4A, BF5A-BF5D, BF8D/BF9.9D, BF15/BF20D	1 lbs	\$14.99

For optimum performance and safety, read the Owner's Manual before operating your Honda marine product. Always wear a personal flotation device while boating.

For genuine Honda Engine Care and Oil, please see pages 24 and 25.



17500-ZZ5-003



Fuel Hose Assembly

### SPARK PLUGS

Item	Model	Engine	Ship	Net
304047	CR4HSB	2 HP Honda BF2D and BF2.3D	1 lbs	\$4.99

### SAFETY LANYARD

Emergency stop lanyard for use on all original equipment, Honda key switch panels and stop switches. Color: Silver, with float.

Item	Model	Ship	Net
302839	36182-ZV4-000AH	1 lbs	\$14.99

### OIL FILTER

Item	Model	Engine	Ship	Net
303313	15400-PFB-014	For BF8 - BF50A	1 lbs	\$14.99

### PLASTIC FUEL TANKS

Includes float gauge and quick-disconnect for fuel line.

Item	Model	Capacity	Ship	Net
302711	17500-ZZ5-013	12 liter/3 gallon	5 lbs	\$119.99
302710	17500-ZZ5-711	25 Liter/6.6 gallon	7 lbs	129.99

### HONDA FUEL HOSE ASSEMBLY Comes with all fittings and primer bulb

Item	Model	Engine	Ship	Net
302744	17700-881-C03ZA	BF5/8, 2001 and older	1 lbs	\$64.99
303023	04101-ZW9-010	BF9.9 - BF130, 2001 and older	2 lbs	59.99
303022	17700-ZW9-030	BF8D - BF130; 2002 and newer	1 lbs	44.99

### DON'T SEE IT?

E-mail questions and inquiries to [outboards@defender.com](mailto:outboards@defender.com).  
If you don't see it, we usually can get it. Special order parts inquiries welcome!  
Include the make, model, year and serial number.

For more detailed product specifications and our complete selection visit [www.defender.com](http://www.defender.com) or call 800-628-8225.



Easy to start, easy to use, and exceptional fuel economy in these compact and lightweight motors make them a great choice for any boater. The new 15 and 20 HP EFI models feature a new adjustable tiller that is comfortable for both left or right hand operation. All models feature a 3 year standard warranty.

FOR CURRENT PRICING, SPECS, AND AVAILABILITY VISIT [WWW.DEFENDER.COM/INFLATABLES](http://WWW.DEFENDER.COM/INFLATABLES) OR EMAIL [OUTBOARDS@DEFENDER.COM](mailto:OUTBOARDS@DEFENDER.COM)

**3-BLADE REPLACEMENT PROPELLERS-All Aluminum except 300392 which is Plastic.**

Item	Model	Engine	Pitch & Dia.	Ship	Net
300392	815083A01	2.5, 3.5 HP, 4-stroke and 2.5 and 3.3 2-strokes	6P x 7-3/8D	1 lbs	\$45.99
300393	812949A02	4-6 HP (4-Stroke) 1999 and up, 4, 5 HP (2-Stroke) 1987 and up	7P x 7.8D	2 lbs	59.99
300394	812950A02	4-6 HP (4-Stroke) 1999 and up, 4 HP, 5 HP (2-Stroke) 1987 and up	8P x 7.8D	2 lbs	59.99
300395	828156A12	6 - 9.9, 15 HP (2-Stroke), 9.9 (4-Stroke) 1995-2004, 15 HP (4-Stroke) thru 2007	9P x 9D	3 lbs	89.99
303489	897614A10	8, 9.9 HP 4-stroke, 2005 and up	7.5P x 8.9D	2 lbs	89.99
303490	897618A10	8, 9.9 HP 4-stroke, 2005 and up	8.5P x 8.9D	2 lbs	89.99
455284	896896A40	25/30 HP (4-Stroke) model year 2006 and up	11P x 9.5D	4 lbs	113.99

**PROPELLER SHEAR PINS**

Item	Model	Engine	Ship	Net
300399	815111Q02	For 2 - 3.5 HP Merc./Mariner/Force, 3 pack	1 lbs	\$6.99

**EPA COMPLIANT MERCURY FUEL TANKS**

- EPA compliant tanks and fuel lines with quick disconnects
- Tanks feature diurnal cap and Mercury's fuel demand valve
- Integral gauge included



Item	Model	Capacity	Dimensions	Ship	Net
304332	8M0047598	3 Gallon	14.5" x 9.75" x 9"	5 lbs	\$107.99
304333	8M0054600	6.6 Gallon	19" x 12.5" x 11.125"	7 lbs	127.99
304335	8M0061098	12' EPA compliant fuel line, designed for EPA compliant Mercury fuel tanks with quick disconnect		2 lbs	59.99



**Parts & Accessories**

**PROPELLERS**

Item	Model	Diameter" x Pitch"	Ship	Net
304244	6G1-45943-00-00	8.5 x 7.5 for F8 & F9.9	2 lbs	\$119.99
304245	6G1-45941-00-00	8.5 x 8.5 for F8 & F9.9	2 lbs	119.99
304246	63V-45943-10-00	9.25 x 11 for F15 & F20	2 lbs	135.99
304247	683-45941-00-00	9-1/4 x 12 for F15 & F20	2 lbs	121.99
305833	6H5-45958-00-00	10-1/4 x 14 for F40	4 lbs	149.99
305835	69W-45945-00-00	11-1/8 x 13 for F40	5 lbs	149.99
305837	6H5-45943-00-00	10 x 15 for F60	6 lbs	149.99
305838	6E5-45947-00-00	13-1/2 x 15 for F70	7 lbs	164.99
305840	6E5-45941-00-00	13 x 19 for F90	8 lbs	164.99

**COMPLETE APPLICATION GUIDE AND LARGER YAMAHA PROPELLERS AVAILABLE AT [WWW.DEFENDER.COM](http://WWW.DEFENDER.COM)**

**EPA COMPLIANT FUEL TANKS & FUEL LINES**

305735	6YL-24201-29-00	3.1 Gallon tank	5 lbs	\$112.99
305736	6YK-24201-44-00	6.6 Gallon Yamaha fuel tank	8 lbs	124.99
304580	6YK-24306-64-00	9.8' Fuel line	2 lbs	61.99
304581	6Y2-24305-06-00	Tank side fuel line connector	1 lbs	18.99

**FILTERS/SPARK PLUGS**

304262	5GH-13440-70-00	Oil filter for F9.9, F15M-MK, F15C-20, F/T25, F30, F40	1 lbs	\$12.99
304267	68T-24251-01-00	In-line fuel filter for F6, F8, F6A, F8C, T8D, F9.9F, T9.9G	1 lbs	17.99
304264	61N-24563-10-00	Primary fuel filter for F15C - 20, F/T25	1 lbs	9.99
304249	BR6HS-10	NGK spark plug for F6, F8, F9.9	1 lbs	3.29



After a successful launch of the world's lightest 4-stroke battery-less EFI motors in the industry, Tohatsu continues to provide lightweight and compact motors without compromising reliability or performance. The LPG 5Hp motor features an exclusive safety fuel shut off valve which keeps propane from continuously running when not in use. All motors meet or exceed the EPA emission regulations and feature a 5 year standard warranty. **Please email inquiries to [outboards@defender.com](mailto:outboards@defender.com).**

**Parts & Accessories**

**EPA COMPLIANT FUEL TANKS WITH GAUGE IN FUEL CAP**

Item	Model	Description	Ship	M.A.P.
304585	3AC701771M	6.6 Gallon	8 lbs	\$73.51
304584	3VI701671M	3.1 Gallon	5 lbs	63.04

**EPA COMPLIANT FUEL LINES WITH PRIMER BULB**

Item	Model	Description	Ship	M.A.P.
304586	99998PBA2M	2-stroke 5 - 90 HP	2 lbs	\$80.22
304587	99998PBA5M	4-stroke 4 - 30 HP	2 lbs	80.22

**FUEL FILTER**

Item	Model	Description	Ship	Net
302836	369022300M	5-9.9 HP and 4 - 30A 4-stroke	1 lbs	\$10.99

**INTERNAL FUEL TANK**

Item	Model	Description	Ship	M.A.P.
302855	309700103M	2.5 and 3.5, 2-stroke	1 lbs	\$38.04
304372	3GT703101M	2 and 3.5, 4-stroke	2 lbs	59.22
302856	369703164M	5B (.66 gallons), 2-stroke	2 lbs	68.98

**FUEL CAP FOR INTERNAL TANK**

Item	Model	Description	Ship	M.A.P.
300444	3GP700200M	2.5A, 3.5A, 3.5B, 2-stroke	1 lbs	\$12.21
302860	393700206M	5B (new style), 2-stroke	1 lbs	11.99
303724	3GP700200	4 HP, 4-stroke	1 lbs	12.99

**FLUSH PLUGS**

Item	Model	Description	Ship	M.A.P.
303041	336600070M	For 4B through 40C, 2-stroke, 2.5-30 4-stroke	1 lbs	\$7.00

**REPLACEMENT PROPELLERS**

Item	Model	Description	Ship	M.A.P.
300429	309641060M	2.5A, 3.5A, 7.4"x5.7", resin, 2-stroke, 2.5/3.5 4-stroke	1 lbs	\$24.44
300430	309B641070	For 2.5, 3.5A and B, 2 and 4-stroke, 7.4" x 6", Aluminum	1 lbs	100.24
300431	3F0641010M	3.5B, 2-stroke, 2, 3.5 4-stroke 7.4" x 7", resin	1 lbs	28.74
303510	3R1B645141	MFS4/MFS5/MFS6 (4-stroke), M4B 2-stroke and M5B (2-stroke) standard 7.7" x 7"	1 lbs	77.15
303511	3R1B645161	MFS4/MFS5/MFS6 (4-stroke), M4B 2-stroke and M5B (2-stroke), standard aluminum, 7.7"x8"	1 lbs	77.15
300433	3B2B645170	8, 9.8 Short shafts, 2 and 4-stroke, 8.5" x 9", aluminum	2 lbs	58.82
300434	3B2B645151	8B, 9.8B Long and 9.8 short shafts, 8.5" x 8", aluminum	2 lbs	58.82
300435	362B641010	9.9B, 15C, 18D short shafts, 2-stroke, 9.9 4-stroke short shaft, 15 4-stroke long, 9.2" x 9", aluminum	2 lbs	61.90
302859	362B641080	15/18/20, 4-stroke, short, 15 and 18, 2-stroke, 9.25" x 10"	2 lbs	61.90

**HIGH THRUST PROPELLERS**

Item	Model	Description	Ship	M.A.P.
303262	399B645121	4/5/6 4-stroke 3 blade high thrust 8.375 x 6	2 lbs	\$77.15
303019	3B2B645120	8/9.8 2 and 4-stroke 4 blade 8.7 x 7	4 lbs	69.12

**SHEAR PINS**

Item	Model	Description	Ship	M.A.P.
300437	309641261M	2.5A, 3.5A, 3.5B, S.S. for all props (5 pk)	1 lbs	\$12.21

**SHUT-OFF LANYARD**

Item	Model	Description	Ship	M.A.P.
300440	353068210M	All engine models	1 lbs	\$14.34

FOR CURRENT PRICING, SPECS, AND AVAILABILITY VISIT [WWW.DEFENDER.COM/INFLATABLES](http://WWW.DEFENDER.COM/INFLATABLES) OR EMAIL [OUTBOARDS@DEFENDER.COM](mailto:OUTBOARDS@DEFENDER.COM)



## Torqueedo Travel

The Torqueedo Travel motors easily propel tenders, dinghies and daysailors up to 1.5 tons. Batteries now feature a USB adapter which allows you to charge your devices using the Travel's battery. The Travel 1003 can do everything a 3hp gas motor can, and is available with either a 530Wh battery, or a 915wh battery for longer ranges. The Travel 503 models come with a 320Wh battery and can do everything a 1.5Hp gas motor can do. Defender now offers the Travel 503 with a 915Wh battery for less draw and more range. This is a Defender Exclusive and only available here!

Item	Model	Shaft	Steering	Battery	Ship
DA 456790	1140-20	24.6" Shaft	Tiller	320wh	64 lbs
DA 456791	1141-20	29.5" Shaft	Tiller	320wh	67 lbs
<b>NOW AVAILABLE WITH A HIGHER CAPACITY 915WH BATTERY - DEFENDER EXCLUSIVE!</b>					
DA 458057	1140-50	24.6" Shaft	Tiller	915wh	64 lbs
DA 456771	1142-20	24.6" Shaft	Tiller	530wh	57 lbs
DA 456772	1143-20	29.5" Shaft	Tiller	530wh	62 lbs
DA 457352	1149-00	24.6" Shaft	Tiller	915wh	57 lbs
DA 457353	1150-00	29.5" Shaft	Tiller	915wh	62 lbs

## TORQUEEDO REPLACEMENT/SPARE BATTERIES & CHARGERS

For battery and charger compatibility chart, please visit [www.defender.com](http://www.defender.com)

Item	Model/Description	Ship	Net
DA 456747	1147-00 530wh battery w/ USB port	16 lbs	\$569.00
DA 456877	1148-00 915wh battery w/USB port	16 lbs	813.00
456775	1133-00 90w Charger for batteries with USB only	2 lbs	113.00
455097	1127-00 40w Charger (for batteries with NO USB)	2 lbs	61.00
456285	1131-10 120W Fast charger (for batteries with NO USB)	2 lbs	112.00

## TORQUEEDO SOLAR CHARGERS

This charger is a high efficiency, foldable and flexible CIGS solar module that simply plugs into the integrated LIMA batteries of Torqueedo Travel models 503/1003.

Item	Model	Description	Ship	Net
456748	1132-00	For Travel and Ultralight batteries 50W	8 lbs	\$609.00

## TORQUEEDO TRAVEL BAGS & COVERS

For Torqueedo Travel 503 / 1003 Model Motors

Item	Model	Ship	Net
456287	1925-00 (1) Motor bag and (1) battery bag	8 lbs	\$198.99
456288	1926-00 (1) Battery bag	2 lbs	69.00
456787	1931-00 Cover for Travel protects shaft head/motor cable	1 lbs	65.00

# EVINRUDE



## Outboard Motors

Defender stocks Evinrude 4-stroke motors as well as the notorious E-TEC models. For current pricing and availability, visit [www.defender.com](http://www.defender.com)



For current pricing, specs, and availability visit [www.defender.com](http://www.defender.com)

## Electric Outboards

For current pricing, specs and availability visit [www.defender.com/outboards](http://www.defender.com/outboards)

### Torqueedo Cruise

The Cruise motors continue to impress with unrivalled efficiency and outstanding range in a lightweight package. With comparable power from 5Hp to 20Hp, they are available in both tiller and remote models. Add a Torqueedo Power Battery (Or batteries depending on setup) and charger (required) to allow your throttle display to work in "Smart mode" for real time updates at your fingertips.

Item	Model/Description	Shaft	Description	Ship
DA 456753	1234 Cruise 2.0TS (24 VDC)	24.6"	Tiller steering	78 lbs
DA 456754	1235 Cruise 2.0TL (24 VDC)	29.4"	Tiller steering	74 lbs
DA 456755	1236 Cruise 4.0TS (48VDC)	24.6"	Tiller steering	74 lbs
DA 456756	1237 Cruise 4.0TL (48 VDC)	29.4"	Tiller steering	78 lbs
DA 456757	1230 Cruise 2.0RS (24 VDC)	24.6"	Remote steering	74 lbs
DA 456759	1232 Cruise 4.0RS (48 VDC)	24.6"	Remote steering	74 lbs

### Torqueedo Power Lithium Manganese 24V Battery

Torqueedo 24V Power Batteries get an upgrade in Spring 2019 to provide 3500Wh of power in the same footprint as it's predecessor. They are not only a green alternative, lasting longer than conventional batteries, but they are fully waterproof to IP67, maintain a high current, do not lose charging capacity and have no memory effect. Torqueedo's 5 stage safety system protects against overcharging, overcurrent, deep discharge, short-circuit and overheating. Using a Torqueedo Power Battery allows your Cruise motor to provide real time information as opposed to estimated when using a conventional battery setup.

Item	Model	Description	Ship	M.A.P.
DA 458277	2106-00	24-3500 24V Power Battery, 3500Wh	65 lbs	\$2999.00
455394	2206-20	Charger for 26-104 and 24-3500 Power Battery	8 lbs	599.00
457090	2304-00	On/Off switch for Torqueedo Power battery	1 lbs	81.00



## TORQUEEDO REPLACEMENT PARTS

Item	Model/Description	Ship	Net
454962	1915-00 HT Prop for Cruise R and T non-splined shaft	2 lbs	\$93.00
454473	1901-00 Propeller for base Travel, Travel, 401, 801, 503 and Cruise models with S/N < 5000	2 lbs	93.00
453782	1917-00 Propeller for Travel 1003	2 lbs	93.00
455625	9234 Skeg for Cruise models 1209-00 and 1223-00	1 lbs	28.00
455626	9145 Skeg for Travel 503/1003	1 lbs	28.00
455627	1914 Magnetic key for Cruise R, Travel 503/1003	1 lbs	28.00
456133	001-00113 Replacement locking pin for Travel 503/1003	1 lbs	14.99
456601	1927-00 Spare parts kit for Travel 503/1003 includes magnetic key, locking pin and battery bolt	1 lbs	43.00
457827	1954-00 For Cruise 2.0 with splined shaft	2 lbs	100.99
457828	1955-00 For Cruise 4.0 with splined shaft	2 lbs	100.99
457591	005-00051 Shear pin for Travel - 5 pack	1 lbs	13.99

## TORQUEEDO TORQ TRAC

Bluetooth data cable connects motor to smartphone enabling use of app. Allows larger display of onboard computer plus app features. For Travel 503/1003, Cruise and Ultralight. App is free. Cable sold separately.

Item	Model	Ship	Net
456749	1924-00	2 lbs	\$128.99

## Parts & Accessories

### BOMBARDIER PROPELLERS

Item	Model	Engine	Diameter" x Pitch"	Ship	Net
303609	778863	15, 25, 30 HP E-TEC	10.3 x 13	4 lbs	\$101.99
303787	765183	40 - 130 HP E-TEC	13.25 x 17	9 lbs	159.99
304232	765184	40 - 130 HP E-TEC	13.2 x 19	9 lbs	159.99
302072	765185	40 - 130 HP E-TEC	13.2 x 21	9 lbs	159.99

### SHUT-OFF LANYARD

Item	Model	Description	Ship	Net
300366	398602	Tiller models	1 lbs	\$12.99
300368	176288	1996 and newer remote models	1 lbs	18.99

### EVINRUDE/JOHNSON FUEL TANKS

Quick disconnect, self-venting, self-sealing fuel connector, scratch-resistant glass lens, built-in tabs to store the fuel line. EPA compliant. Guaranteed for 3 years.

Item	Model	Description	Ship	Net
304238	5008623	6 Gal. with fuel gauge	7 lbs	\$107.99
303115	5008609	8', 5/16 Fuel line w/primer bulb and fittings	2 lbs	56.99

### FUEL FILTERS/SPARK PLUG

Item	Model	Description	Ship	Net
300676	354016	In-line fuel filter for 15HO - 30 E-TEC	1 lbs	\$16.99
300675	5007419	NGK QC10WEP spark plug for 15HO and up E-TEC	1 lbs	14.99
303611	398327	In-line fuel filter for 5/16" hose	1 lbs	9.99
303610	360941	In-line fuel filter for 3/8" hose	1 lbs	9.99

### Forespar Nova Lift™

Easily load and unload heavy motors and equipment. Complements all man overboard recovery systems. Simple to remove from deck while cruising. Self-feeding tube allows line to be quickly rigged. Rotates 360°. Electro polished 304 stainless steel. 220 lbs SWL.

Item	Model	Description	Ship	M.A.P.
451109	153311	Nova Lift (Fits 1" rail)	16 lbs	\$609.60
453549	153312	Nova Lift with winch	18 lbs	751.20
650100	153387	1-1/4" Rail Kit	1 lbs	Net 89.99



### Forespar Motor Mate™

Corrosion-resistant. White powder-coated aluminum. Mounts and dismounts with ease and stows in its own 31" x 6" bag. Comes with tackle and will lift anything up to 100 lbs. Boom length 20". Assembled height 54". For both powerboats and sailboats.

Item	Model	Description	Ship	Net
450515	153100	Motor Mate complete	10 lbs	\$511.99
450516	153104	Extra base mount	1 lbs	61.99



### EasyLift MotorTote® by C-Level

Comes with Saf-T-Strap, which locks the fore and aft straps together, encircling the motor to prevent slipping. Strong acetel side-release buckles make the device easy to attach or remove.

Item	Model	Description	Ship	Net
450699	8877	Universal (2-15 HP)	1 lbs	\$37.99
		Max weight 100 lbs		
450700	8789	Heavy Duty (15-30 HP)	1 lbs	47.99
		Max weight 150 lbs		
453281	9197	Super Heavy Duty (30 HP and up)	2 lbs	71.99
		Max weight 400 lbs		



### Garelick Outboard Motor Carriers

**A. Motor Carrier for up to 85 lbs Engines**  
Tough 1" aluminum tubing; semi-pneumatic rubber tires mounted on strong steel axle. 35" high.

Item	Model	HP	Ship	Net
450534	31400	Up to 15	16 lbs	\$94.99

**B. Motor Carrier for up to 130 lbs Engines**  
Same features as above plus fold down gas can holder with tie down strap. 36-3/4" high.

Item	Model	HP	Ship	Net
450535	31600	Up to 30	22 lbs	\$124.99



### HelmsMate Tiller Extension Handles

The HelmsMate Motor Extension Handle simply clamps onto the motor's tiller handle to enable you to control speed and direction without having to sit next to the motor.

The HelmsMate U-model offers a unique, all metal universal joint that enables the handle to fit up over a transom and to provide offset steering.

Lifetime warranty: Free replacement or repair for the life of the handle if anything goes wrong.

- Clamps directly to the tiller handle for steering and throttle control
- Fits all tiller handles on motors up to 15 HP
- Clear access to the kill button
- Marine grade construction; Made in the USA



Item	Model	Description	Ship	Net
302173	001.21	Basic Handle fixed length of 18"	1 lbs	\$18.99
300740	001.2	Basic Handle fixed length of 30"	1 lbs	22.99
300739	001.1	Straight Handle extends from 36" to 50"	2 lbs	36.99
302170	001.0	Metal U-Joint Handle extends from 37" to 52"	2 lbs	55.99
302174	001.22	Extendable 18" to 24"	1 lbs	24.99

### Garelick Retractable Outboard Motor Brackets

The handiest way to equip a small sailboat with auxiliary power - or a fishing craft with a low-powered trolling engine - is to mount an outboard motor on the transom by means of a retractable bracket. This kind of bracket allows the boatman to lift the motor out of the water when it is not in use without removing it from the bracket.

Item	Model	Motor Type	HP	Material	Max. Motor Weight	Vertical Travel	Mounting Plate Size	Ship	Net
300703	71042	2-stroke	7.5 - 12	Aluminum	82 lbs	14-1/4"	11-1/2" W x 10-3/4" H x 2" D	14 lbs	\$174.99
302211	71057	2-stroke	7.5 - 20	Aluminum	115 lbs	11-1/4"	11-1/2" W x 10-3/4" H x 2" D	15 lbs	162.99
303619	71090	4-stroke	7.5 - 30	Aluminum	169 lbs	9-1/2"	11-1/2" W x 10-3/4" H x 2" D	19 lbs	274.99
303618	71091	4-stroke	7.5 - 25	Aluminum	175 lbs	15-1/2"	11-1/2" W x 12" H x 2" D	31 lbs	399.99
302169	71040	2-stroke	Up to 8	Aluminum	59 lbs	8-1/2"	11-1/2" W x 10-3/4" H x 2" D	13 lbs	154.99
302167	71056	2-stroke	7.5 - 20	Stainless Steel	115 lbs	11-1/4"	11-1/2" W x 10-3/4" H x 2" D	17 lbs	199.99
300705	71033	2-stroke	7.5 - 25	Stainless Steel	118 lbs	11-1/4"	11-1/2" W x 10-3/4" H x 2" D	20 lbs	254.99

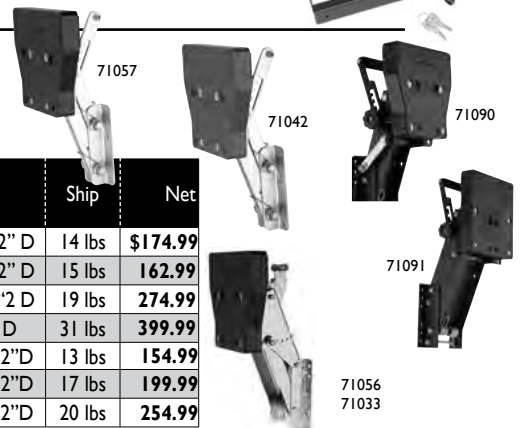

### Weaver MotoSto Platform

Store your motor horizontally on the swim step, transom or swim platform. When underway, the bracket is in the normal position and when using the motor, the bracket can be swung out of the way against the transom. The bracket is not removable on the transom mount model. The bracket on the swim platform model is removable, leaving the low profile receiver plate.



Item	Model	Description	Ship	Net
300013	MOTOSTOTR	Transom mount for 15 HP motors	13 lbs	\$352.99
300012	MOTOSTOSW	Swim platform	15 lbs	294.99

### Edson Outboard Motor Bracket

- Holds motors up to 15 HP or 100 lbs on your stern rail
- Convenient cleat and side handles for locking the motor
- All hardware included

Item	Model	Material	Rail Size	Ship	Net
300711	521-100ST	Stainless	1"	12 lbs	\$342.99
303478	521-125AL	Aluminum	1-1/4"	13 lbs	396.99



### Garelick Fixed Motor Bracket

- Polyethylene outboard mounting board. Vibration reducing rubber-bushing
- Takes 2-stroke motors up to 15 HP
- 8"W x 8.5" D
- Vertical transom mount

Item	Model	Material	Ship	Net
300710	71074	Stainless Steel	8 lbs	\$79.99



### SeaTeak Outboard Mounting Bracket

- Dimensions: 7" L x 6-7/8" H x 1-3/4" W
- Designed to hold motors up to 12 HP
- Hand sanded and hand finished 100% teak

Item	Model	Ship	Net
300915	60326	2 lbs	\$39.99

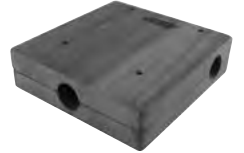

### Garelick Motor Tilter

- Helps to tilt motor back safely with less strain
- Lightweight, compact
- Can handle motors up to 40 HP
- Adjusts to fit covers of any outboard motor with hand hold
- Heavy gauge 1" 304 stainless steel and anodized aluminum tube and durable aluminum castings cushioned at all contact points to prevent marring

Item	Model	Ship	Net
300735	71036	4 lbs	\$74.99
456802	71035	4 lbs	69.99



### Blue Performance Outboard Motor Covers

Material - Gray, ripstop nylon.

Item	Model	HP Size	Ship	Net
608144	BP751	2-3.3	1 lbs	\$47.99
	BP752	4-8.8	1 lbs	51.99
	BP753	9.9-15	2 lbs	55.99
	BP754	20-25	2 lbs	59.99



### Fulton Outboard Motor Lock

Mounts on most outboard motors. Heavy gauge steel construction. Foam insert reduces noise and vibration. 2 keys included.

Item	Model	Ship	Net
302171	OML 0127	3 lbs	\$34.99





**SCEPTER PORTABLE FUEL TANK**

- Includes mechanical direct sight gauge
- Material: plastic • Meets EPA/ CARB standards

Item	Model	Description	Ship	Net
301676	08669	12 gallon - Low perm low profile portable fuel tank	30 lbs	\$84.99
301997	08667	9 gallon - Low perm low profile portable fuel tank	9 lbs	72.99
302166	08668	12 gallon - Eco tall profile portable fuel tank	11 lbs	84.99



**SCEPTER UNDERSEAT FUEL TANK**

- Convenient combination fuel pick-up / sight gauge
- Molded feet provide increased ventilation and stability
- Uses 1/4 NPT marine tank fittings
- Seamless one-piece polyethylene tank shell construction

Item	Model	Capacity	Dimensions (L x W x H)	Ship	Net
305855	10506	3 gallon	19.3" x 12.2" x 6.8"	5 lbs	\$59.99
305856	10511	6 gallon	19.3" x 12.2" x 10.2"	6 lbs	64.99



**SCEPTER NEPTUNE PORTABLE FUEL TANK**

- Smaller tank with off-set ergonomic handle eases portability
- Uses 1/4 NPT marine tank fittings
- Seamless one-piece polyethylene tank shell construction

Item	Model	Description	Ship	Net
301998	08592	6 gallon	9 lbs	\$56.99
301999	08590	3 gallon	5 lbs	49.99



**ALL MOELLER PORTABLE ABOVE DECK AND TOPSIDE TANKS FEATURE:**

- 90° fuel withdrawal assembly that rotates 360° to reduce fuel line kinks
- Direct sight fuel gauge with glass lens for years of clear viewing

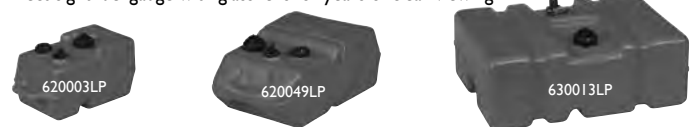

- Perfect for storage in transom well or other small areas
- With handle

Item	Model	Capacity	Dimensions (L x W x H)	Ship	Net
304321	620003LP	3 gallon	16.60" x 8.50" x 9.60"	5 lbs	\$58.99
304323	620049LP	6.5 gallon	21.5" x 13.18" x 10.10"	9 lbs	64.99
304322	620040LP	6 gallon bow	18.67" x 15.23" x 10.97"	8 lbs	79.99

**MOELLER TOPSIDE FUEL TANKS**

- Reserve fuel area is designed right into the tank
- No handle
- When gauge registers empty, simply tilt tank and the reserve fuel supply becomes available

Item	Model	Capacity	Dimensions (L x W x H)	Ship	Net
302142	630009LP	9 gallon	23.06" x 14.25" x 11.57"	9 lbs	\$99.99
304331	630013LP	12 gallon	24.51" x 17.76" x 10.82"	15 lbs	111.99

**MOELLER "LOW PERM" FUEL LINE ASSEMBLIES**

- 6 PSI leak tested; 40 lbs pull test on fitting connections
- Meets "low permeation" standards put in place by EPA/CARB regulations effective 1/1/2011
- 3/8" ID UltraViolet and E10 resistant hose
- All ship 2 lbs

Item	Model	Description	Net
304310	034385-10LPA	Mercury two prong clip style; 1998 and newer engines	\$51.99
304311	034388-10LPA	Mercury bayonet style (cast aluminum fittings)	51.99
304312	034390-10LPA	Universal, 3/8" ID Hose, BI-15, 80"	44.99
304313	034391-10LPA	Bombardier (Johnson/Evinrude)	52.99
304314	034394-10LPA	Yamaha	46.99
304316	034590-10LP	Low perm primer bulb, Inlet/Outlet: 3/8" hose barbs	19.99
304317	034690-10LP	Low perm primer bulb, Inlet/Outlet: 5/16" hose barbs	19.99



**SCEPTER EXPANDABLE TANK HOLD DOWN KIT**

- Applications: most portable and topside fuel tanks
- Includes (2) adjustable 72" nylon straps, max. Length: 72"
- Quick-release stainless steel buckles, (4) SS hold-downs

Item	Model	Description	Ship	Net
302168	10837	Tank hold down kit	1 lbs	\$29.99



**SCEPTER DURAMAX FLO N' GO WHEELED FUEL CADDY**

- 14 gallon capacity
- Wheeled for easy transport
- Includes patented Flo n' Go hand pump
- Meets D.O.T. and UN Transportation requirements
- Includes 10' long hose
- Dual mechanical shut-off valves for spill-roof Flo n' Go disconnection

Item	Model	Description	Ship	Net
302158	06792	DuraMax portable fuel container	29 lbs	\$124.99



**MOELLER REED SWITCH TANK SENDING UNIT**

- More Consistent than Swing-arm Senders, Includes 5-Hole Gasket and Screws
- Calibrated to the Industry Standard of 33-240 Ohms

Item	Model	Description	Ship	Starting At
302679	0357XX-XX	Select tank depth	1 lbs	\$59.99



**SCEPTER GLASS VIEW INLINE FUEL FILTER**

- Applications: Outboard Engine Use ONLY
- Includes 3/8", 5/16" and 1/4" Hose Barbs

Item	Model	Ship	Net
302670	07109	1 lbs	\$12.99

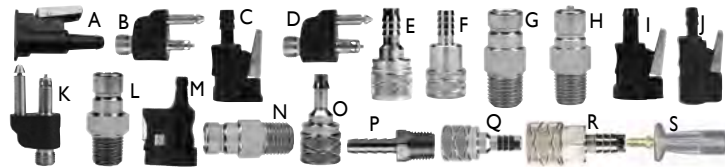

**MOELLER OUTBOARD CONNECTORS**

Item	Model	Description	Ship	Net
A	300153	033480-10 OMC engine, 3/8" Barb fuel line		\$7.99
B	300154	033400-10 OMC tank, 1/4" NPT		8.99
C	300155	033481-10 Yamaha engine, 3/8" hose		7.99
D	300156	033470-10 Yamaha tank, 1/4" NPT		8.99
E	300157	033451-10 Nissan engine, 3/8" barb, up to 90 hp		16.99
F	300158	033492-10 Nissan engine, 3/8" barb, 90+ hp		17.99
G	300159	033450-10 Nissan tank, 1/4" NPT, up to 90 hp		13.99
H	300160	033491-10 Nissan tank, 1/4" NPT, 90+ hp		12.99
I	300161	033482-10 Mercury and Yamaha engine, 3/8" clip 1998+		9.99
J	300163	033486-10 Mercury tank side 3/8" hose, 1998+		10.99
K	304192	033477-10 Mercury tank, 1/4" NPT, 1998+		10.99
L	300102	033496-10 Honda tank; 1/4" NPT		9.99
M	300103	033497-10 Honda engine, 3/8" Barb		9.99
N	300104	033501-10 Honda tank, 1/4" NPT, up to 90 hp		13.99
O	300105	033502-10 Honda tank, 3/8" Barb, up to 90 hp		16.99
P	304304	033405-10 Male hose barb, 3/8" barb x 1/4" NPT, up to 90 hp		5.99
Q	304309	033487-10 Suzuki fuel line to engine connector fitting, 3/8" barb		14.99
R	305649	033488-10 Suzuki fuel line to tank replacement connector, 3/8" barb		14.99
S	305647	033418-10 Mercury fuel line to engine or tank replacement bayonet connector, 3/8" barb		14.99

(OMC is for Johnson and Evinrude Engines)

**MOELLER 3-WAY FUEL VALVE**

- (3) Connections: 3/8" NPT, connects (2) permanent tanks to a single motor

Item	Model	Ship	Net
305651		1 lbs	\$36.99



**MOELLER ALUMINUM ANTI SIPHON VALVE**

Item	Model	Ship	Net
306428		1 lbs	\$12.99
		1 lbs	13.99



**MALE HOSE BARB**

- All brass machined fittings
- Ideal for fuel fitting applications

Item	Model	Description	Ship	Net
300247	20801	1/4" hose, 1/4" NPT	1 lbs	\$3.99
300248	20811	5/16" hose, 1/4" NPT	1 lbs	3.99
300249	20821	3/8" hose, 1/4" NPT	1 lbs	3.99



**CONBRACO APOLLO BRONZE PIPE TO HOSE ADAPTER**

- 1/2" to 2-1/2" ID hose
- 3/4 to 2" NPT

Item	Model	Ship	Net
503498		2 lbs	Starting at \$6.99



**CONBRACO APOLLO FUEL SHUT-OFF VALVE**

- Bronze with stainless steel lever and nut
- 400 PSIG rating
- Fast 90° On-Off turn
- Specify: 1/4", 3/8" or 1/2" thread

Item	Model	Ship	Net
300767		1 lbs	\$32.99



**MOELLER PERMANENT TANKS**

Moeller Marine Products below deck tanks are specifically designed for the recreational marine industry. Tanks meet all applicable ABYC, USCG and CE requirements and are suitable as replacement tanks for boats built before 2011. Fittings are located in different positions. Visit [www.defender.com](http://www.defender.com) for specific pictures of tanks.

Item	Model	Gal.	Dimensions	Ship	Net
300168	032512	12	24.50"L x 18.50"W x 9.75"H	15 lbs	\$190.99
D 300169	032612	12	20.00"L x 14.00"W x 14.50"H	28 lbs	195.99
300170	032514	14	18.00"L x 11.75"W x 19"H	12 lbs	185.99
D 300171	032518	17	36.50"L x 18.25"W x 10.00"H	40 lbs	246.99
D 300177	032718	19	39.00"L x 8.25"W x 5.25" WB x 20.50"H	39 lbs	231.99
D 300172	032519	19	26.00"L x 16.00"W x 14.50"H	31 lbs	214.99
D 300173	032619	19	18.50"L x 14.00"W x 20.75"H	31 lbs	198.99
D 300174	032818	20	58.00"L x 6.00"W x 17.50"H	32 lbs	259.99
D 300176	032719	19	47.00"L x 10.25"W x 12.94"H	33 lbs	231.99
D 300175	032520	20	26.00"L x 11.75"W x 19.00"H	29 lbs	203.99
D 300178	032624	24	51.00"L x 8.75"W x 5.00" WB x 20.63"H	54 lbs	278.99
D 300179	032525	25	47.00"L x 18.03"W x 10.25"H	51 lbs	273.99
D 300180	032527	27	36.50"L x 16.00"W x 14.50"H	42 lbs	236.99
D 300181	032535	35	69.50"L x 16.00"W x 11"H	75 lbs	330.99
D 300182	032550	50	45.00"L x 12.50"W x 24.75"H	78 lbs	332.99
300197	035710		Hold down bracket kit (4 / per kit)	1 lbs	24.99

\* 33-240 OHMS sending unit installed

**MOELLER FUEL SENDER KITS**

Item	Model	Tank Depth	Description	Ship	Net
306429	035794-10	6"-24"	Reed array sender with gauge	1 lbs	\$59.99
304318	035722-10	6"-12"	Electric sender kit for gas w/o gauge	1 lbs	26.99
300167	035724-10	12"-24"	Electric sender kit for diesel with diesel return line	1 lbs	49.99
300166	035726-10	4"-28"	Electric fuel gauge swingarm sending unit kit	2 lbs	52.99



### Fuel Products

**TRIDENT PREMIUM A2 FILL, VENT AND TRANSFER CORRUGATED FUEL HOSE** Ships 1 lbs/ft.

- Wire helix between 2-ply reinforcement for very tight bends
  - Meets ABYC, USCG, SAE, ISO, CE, Lloyds and is NMMA accepted
  - For gasoline, alcohol blends, diesel and bio-diesel
- | Item   | Model   | Inside Dia. | Max Bend | Ship  | Net/Ft. |
|--------|---------|-------------|----------|-------|---------|
| 756217 | 329-112 | 1-1/2"      | 3.5"     | 1 lbs | \$15.99 |
| 756218 | 329-200 | 2"          | 5"       | 2 lbs | 25.99   |

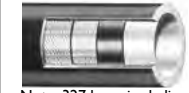

Note: 327 has wire helix

**PREMIUM FUEL FILL, FEED AND VENT HOSE** Ships 1 lbs/ft.

- Fire retardant A1 (365) or A2 (327) fuel hose meets or exceeds all requirements of USCG/SAE/ISO/ABYC/CE
- Resistant to gas, diesel, alcohol enhanced fuels, heat and ozone
- Excellent flexibility
- 365 series is barrier proof

Item	Model	Type	ID"	Net/Ft.	Item	Model	Type	ID"	Net/Ft.
500561	327-112	Fill	1-1/2"	\$11.99	503671	365-038	Feed	3/8"	\$3.49
503671	365-014	Feed	1/4"	2.99		365-012	Feed	1/2"	3.99
	365-056	Feed	5/16"	3.29		365-058	Vent	5/8"	4.99

**TRIDENT PREMIUM OUTBOARD B1-15 BARRIER LINED FEED FUEL HOSE** Ships 1lbs/ft.

- 2 spiral hose reinforced with inner barrier liner; good bend radius
- Meets ABYC, USCG, SAE, ISO, CE, EPA and is NMMA accepted
- For gasoline, alcohol blends (CE-10), diesel and bio-diesel

Item	Model	Size/ID	Net/Ft.
301989	305-0140	1/4"	\$2.69
	305-0560	5/16"	2.69
	305-0380	3/8"	2.90



**WHITECAP 316 STAINLESS STEEL KEYLESS PUSHUP DECK FILL**

- Includes safety chain (except Waste fill)
- Please Specify:** Diesel Green, Gas Red, Water Blue, Waste Black

Item	Hose	Orientation	Flange	Ship	Net
650971	1-1/2"	90°	3"	1 lbs	\$47.99
650973	1-1/2"	30°	3"	1 lbs	69.99



**Please Specify:** Diesel Green, Gas Red

650972	2"	90°	3-1/2"	2 lbs	69.99
--------	----	-----	--------	-------	-------



**WHITECAP 316 STAINLESS STEEL HOSE DECK FILL**

All models include key. Uses #10 screws. All ship 1 lbs.

Item	Model	Code	Hose	Flange	Net
651022	6123	Gas	1-1/2"	3"	\$33.99
	6124	Diesel	1-1/2"	3"	33.99
	6125	Water	1-1/2"	3"	33.99
	6126	Waste	1-1/2"	3"	33.99
303170	6060	Spare key for 6123, 6124, 6125, 6126			9.99
650758	6061OR	Replacement O-ring for deck fill cap			6.99



**WHITECAP EPA PULL-UP DECK FILL**

316 stainless steel. All ship 1 lbs.

Item	Model	Application	Hose Barb	Angle	Net
651055	6124EPA	Diesel	1-1/2"	90°	\$46.99
	6123EPA	Gas	1-1/2"	90°	46.99
	6125EPA	Water	1-1/2"	90°	46.99
	6126EPA	Waste	1-1/2"	90°	46.99
	6395EPA	Diesel	2"	90°	53.99



**DAVIS SNAP TOOL - MULTI-KEY**

- Deck plate key
- Un-Snap/Snap canvas snaps
- Zipper pull
- Cutting tool
- Hex wrench
- Screwdrivers
- Scraper
- Pin shackle key
- Bottle opener

Item	Model	Ship	Net
651032	382	1 lbs	\$11.99

**GREEN MARINE FUEL WHISTLE**

Easily installed into the fuel tank vent line. During fueling, an audible whistle is produced as air escapes. When the tank is full, the whistling stops, giving warning to stop filling.

Item	Fits vent line	Ship	Net
300109	5/8" (adapts to up to 1-1/2")	1 lbs	\$29.99



**WHITECAP 316 STAINLESS STEEL TANK VENTS WITH WIRE SCREEN**

Item	Model	Type	Hose	Cutout	Ship	Net
300829	6004	Straight	5/8"	3/4"	1 lbs	\$14.99
300830	6023	90°	5/8"	3/4"	1 lbs	18.99



### Fuel Pumps

**TERA PUMP BATTERY OPERATED FUEL PUMPS**

- Flow rate: 2.5 GPM. Portable and lightweight
- Batteries not included

Item	Model	Description	Ship	M.A.P.
302202	TREP01	Requires (2) D batteries	2 lbs	\$39.99
302203	TRHA01	Requires (2) AA batteries	1 lbs	19.99

**BATTERY OPERATED FUEL TRANSFER PUMP**

- Auto stop and leak protection
- Flow rate 3 gallons per minute
- Requires 4 AA batteries (not included)

Item 301993	Model TRFA01	Ship 3 lbs	M.A.P. \$59.99
-------------	--------------	------------	----------------

**MANUAL FUEL TRANSFER PUMP**

- Bendable intake hose
- 3 different gas can adapters
- Flow rate up to 3.2 gallons per minute

Item 301994	Model TRM20	Ship 2 lbs	Net \$13.99
-------------	-------------	------------	-------------



### Engine Care Products

**YAMAHA RING FREE PLUS FUEL ADDITIVE**

Provides superior deposit control; cleans fuel injectors, carburetors, intake valves, intake ports and combustion chambers. Featuring metal filers, it also protects silver solder, copper, aluminum and steel in a fuel system from the corrosive effects of ethanol sulfate salt.

Item	Model	Size	Ship	Net
304234	ACC-RNGFR-PL-12	12 ounces	1 lbs	\$19.99
304235	ACC-RNGFR-PL-32	32 ounces	4 lbs	49.99



**YAMAHA MARINE LOWER UNIT GEARCASE LUBE**

- Special high viscosity, extreme pressure additives protect gears in high speed and high load conditions for extended operating periods
- Formulated for use in fresh or saltwater applications
- Includes robust rust and corrosion inhibitors for long life
- Recommended for all Yamaha outboard and stern drives\*

Item	Model	Size	Ship	Net
301416	ACC-GEARL-UB-QT	Quart	2 lbs	\$10.99

\* Not to be used in V-8 F300 ~ F350, V-6 VMAX SHO 200~250 engines



**UNIKAS FUEL WATER SEPARATOR**

Fits all outboards up to 350 hp with a maximum fuel flow of 31 GPH. Comes with the fuel line adapters and a filter element. Removes 99.9% of water present in fuel tank; transparent bowl allows you to see how much water has been trapped. Easy access drain valve allows you to empty without removing filter. Easy to install and corrosion resistant.

Item	Model	Description	Ship	M.A.P.
304105	99999UF10K	Fuel/water separator	2 lbs	\$74.01
304106	99999UF10RF	10 micron replacement element	1 lbs	Net 17.99



**CRG ENGINE STOR FOGGING OIL**

Protects marine engines during seasonal storage. Clings to internal components to keep pistons, rings and cylinder walls corrosion free.

Item	Model	Description	Ship	Net
754118	06068	13 oz. aerosol	2 lbs	\$6.99



**STAR BRITE FOGGING OIL**

Prevents corrosion when storing inboard or outboard engines for an extended period of time. Special formula makes starting engine after storage quick and easy.

Item	Model	Description	Ship	Net
755178	84812	12 oz. spray	1 lbs	\$3.99



**REPLACEMENT SPARK PLUGS** All ship at 1 lbs.

Please consult your owner's manual to find out which one your engine uses. Information is also available at [www.defender.com](http://www.defender.com).

**NGK SPARK PLUGS**

Item	Model	Net	Item	Model	Net
300447	97010101IM	\$2.99	300415	DPR6EA-9	\$3.69
300449	970101005M	2.99	302712	DCPR6E	4.99
300414	CR6HS	3.49	300410	BUHW-2	4.99
			300413	BPZ8HS-15	11.99



**CHAMPION SPARK PLUGS**

300376	L77JC4	\$2.69	300379	QL86C	\$4.49
300375	L87YC	2.69	300380	QL82C	4.49



08739-90VV



775603



778755



778754



92-802859A1

**HONDA ENGINE CARE PRODUCTS**

Item	Model	Description	Ship	Net
303809	08739-90VV	Lower unit gearcase oil, Quart	2 lbs	\$6.49
303810	08207-TNT32	Power trim and tilt fluid, Quart	2 lbs	5.99

**EVIRUDE/JOHNSON ENGINE CARE PRODUCTS**

303106	775603	10 oz. tube, Hi-vis gearcase lube	1 lbs	\$6.99
302558	508298	8 oz. tube, Triple guard grease	1 lbs	6.99
303495	775612	10 oz. tube, Power trim/Tilt steering fluid	1 lbs	6.99
303113	777191	11 oz. spray, Carburetor/Choke cleaner	1 lbs	8.99
300475	778755	32 oz., HPF PRO gearcase lube	2 lbs	15.99
300769	778754	32 oz., HPF PRO gearcase lube kit with pump	3 lbs	26.99

**MERCURY ENGINE CARE PRODUCTS**

302559	92-802859A1	8 oz. tube, 2-4-C marine lubricant with teflon	1 lbs	\$7.99
302468	92-802844K01	8 oz. tube, premium gear lube	1 lbs	5.99
300019	92-858077K01	32 fl. oz., power trim and steering fluid	2 lbs	15.99
300017	92-858064K01	32 oz. bottle, high performance gear lube	3 lbs	13.99

**TOHATSU ENGINE CARE PRODUCTS**

302560	332823180M	Tohatsu marine grease	1 lbs	\$5.61
		14 oz. tube- for standard grease gun (not included)		
304043	332823200M	8 oz. fuel stabilizer	1 lbs	3.27
304045	999993785I	Water separator filter kit	3 lbs	28.53
304044	3Y9022340M	Water separator replacement filter	2 lbs	6.60
304046	3R0076150M	Oil filter for 9.9 thru 60 hp, 4-stroke	1 lbs	10.24



## Engine Lubricants



### TWO-CYCLE MOTOR OIL

Item	Model/Description	Size	Ship	Net
779725				
779718				
779711				
LUB-2STRK-MI-12				
LUB-2STRK-MI-04				
08207-10W30MFC-W				
<b>302319</b>	<b>779724 BRP XPS XD30 Synthetic blend 2-stroke Oil</b>	Quart	2 lbs	<b>\$9.99</b>
	<b>779725 BRP XPS XD30 Synthetic blend 2-stroke Oil</b>	Gallon	8 lbs	<b>35.99</b>
	<b>779726 BRP XPS XD30 Synthetic blend 2-stroke Oil</b>	2.5 Gallon	19 lbs	<b>76.99</b>
<b>302320</b>	<b>779717 BRP XPS XD50 Synthetic blend 2-stroke Oil</b>	Quart	2 lbs	<b>8.99</b>
	<b>779718 BRP XPS XD50 Synthetic blend 2-stroke Oil</b>	Gallon	8 lbs	<b>34.99</b>
	<b>779719 BRP XPS XD50 Synthetic blend 2-stroke Oil</b>	2.5 Gallon	19 lbs	<b>82.99</b>
<b>302321</b>	<b>779711 BRP XPS XD100 Synthetic Blend Direct Injection Outboard Oil</b>	Gallon	8 lbs	<b>42.99</b>
<b>302276</b>	<b>LUB-2STRK-MI-12 Yamalube TCW3 Oil</b>	Quart	3 lbs	<b>9.99</b>
	<b>LUB-2STRK-MI-04 Yamalube TCW3 Oil</b>	Gallon	8 lbs	<b>35.99</b>
	<b>LUB-2STRK-MI-02 Yamalube TCW3 Oil</b>	2.5 Gallon	19 lbs	<b>88.99</b>

### TOHATSU FOUR-CYCLE MOTOR OIL

Item	Model/Description	Size	Ship	Net
<b>302282</b>	<b>332823080M Tohatsu FC-W 4-cycle Oil</b>	Quart	2 lbs	<b>\$6.56</b>
<b>302282</b>	<b>332823050M Tohatsu FC-W 4-cycle Oil</b>	Gallon	8 lbs	<b>22.41</b>

### EVINRUDE/JOHNSON FOUR-CYCLE MOTOR OIL

Item	Model/Description	Size	Ship	Net
<b>302226</b>	<b>775595 Evin/John Cobra 4-cycle Oil **</b>	Quart	2 lbs	<b>\$6.99</b>
<b>302226</b>	<b>775596 Evin/John Cobra 4-cycle Oil **</b>	Gallon	8 lbs	<b>18.99</b>
<b>302471</b>	<b>764365 Evin/John 4-stroke Oil</b>	Quart	3 lbs	<b>\$7.99</b>

\*\* Acceptable for any diesel engine which requires a 30 weight oil

### FOUR-STROKE MOTOR OIL

Item	Model/Description	Size	Ship	Net
<b>303868</b>	<b>08207-10W30MFC-W Honda 4-stroke Oil 10W30</b>	Quart	2 lbs	<b>\$5.99</b>
<b>302277</b>	<b>LUB-10W30-FC-12 Yamalube 4-stroke Oil 10W30</b>	Quart	2 lbs	<b>7.99</b>
<b>302277</b>	<b>LUB-10W30-FC-04 Yamalube 4-stroke Oil 10W30</b>	Gallon	8 lbs	<b>27.99</b>
<b>304037</b>	<b>LUB-20W40-FC-12 Yamalube 4-stroke Oil 20W40</b>	Quart	2 lbs	<b>8.99</b>
<b>302286</b>	<b>92-8M0078625 Mercury 4-stroke Oil 10W30</b>	Quart	2 lbs	<b>6.99</b>
	<b>8M0078626 Mercury 4-stroke Oil 10W30</b>	Gallon	9 lbs	<b>26.99</b>
<b>302287</b>	<b>92-8M0078627 Mercury 4-stroke Oil 25W40</b>	Quart	2 lbs	<b>7.29</b>
	<b>8M0078628 Mercury 4-stroke Oil 25W40</b>	Gallon	9 lbs	<b>25.99</b>

OIL CHANGERS, FILTERS AND ABSORBERS ON PAGES 26-27

## Fuel Additives

### HAMMONDS BIOBOR™ JF FUEL ADDITIVE

Prevents microbial growth, kills existing bacteria, algae and fungus and stops corrosion caused by microorganisms. Prevents plugging of filters due to organic growth. Works up to 10 times faster than other diesel fuel biocides.

Item	Model	Size	Ship	Net
<b>302104</b>	<b>BIO8OZ</b>	8 oz., Treats 640 gallons	1 lbs	<b>\$15.99</b>
<b>302104</b>	<b>BIO16OZ</b>	16 oz., Treats 1280 gallons	2 lbs	<b>19.99</b>

### HAMMONDS BIOBOR™ DIESEL FUEL ADDITIVE

• Reduces soot, increases Cetane, stabilizes and prevents corrosion  
• Anti-gel and lowers CFPP • Inhibits corrosion and restores lubricity  
• Size: 16 ounces treats 120 gallons of diesel fuel

Item	Model	Size	Ship	Net
<b>301636</b>	<b>BBMD16EZ</b>	16 oz.	2 lbs	<b>\$14.99</b>

### STAR TRON GAS AND DIESEL ADDITIVE

This enzyme-based formula increases fuel economy and power, reduces emissions, prevents fuel oxidation, eliminates carbon build-up in fuel delivery system and on exhaust components, treats water build-up and prevents the formation of sludge and varnish for up to 2 years. Gas INITIAL DOSAGE: Add 1 fl. oz. (30 ml) for every 8 gallons (30 L) of gas. REFILL: Add 1 fl. oz. (30 ml) for every 16 gallons (60 L) of gas. Diesel INITIAL DOSAGE: Add 1 fl. oz. (30 ml) for every 16 gallons (60 L) of fuel. REFILL: Add 1 fl. oz. (30 ml) for every 32 gallons (120 L) of fuel.

Item	Model	Size	Fuel Type	Ship	Net
<b>302121</b>	<b>93008</b>	8 oz.	Gas	1 lbs	<b>8.99</b>
	<b>93016</b>	16 oz.	Gas	2 lbs	<b>17.99</b>
	<b>93032</b>	32 oz.	Gas	2 lbs	<b>23.99</b>
<b>302115</b>	<b>93108</b>	8 oz.	Diesel	1 lbs	<b>11.99</b>
	<b>93116</b>	16 oz.	Diesel	1 lbs	<b>19.99</b>
	<b>93132</b>	32 oz.	Diesel	2 lbs	<b>31.99</b>

### EZ-TO-STORE EZ-TO-START GAS AND DIESEL ADDITIVE

Stabilizes and fogs in one step. Great for inboard and outboard winter storage. Unique formula combines gas stabilizers with a polymer coating that acts like fogging oil. Completely corrosion proofs all internal engine surfaces. 1 oz. treats 5 gallons of gas. 1 oz. treats 10 gallons of diesel. All ship 1lbs except 84332 (2 lbs)

Gas				Diesel			
Item	Model	Size	Net	Item	Model	Size	Net
<b>302114</b>	<b>84308</b>	8 oz.	<b>\$7.49</b>	<b>302111</b>	<b>84408</b>	8 oz.	<b>\$6.99</b>
<b>302114</b>	<b>84316</b>	16 oz.	<b>9.79</b>	<b>302111</b>	<b>84416</b>	16 oz.	<b>9.79</b>
<b>302114</b>	<b>84332</b>	32 oz.	<b>12.99</b>				

## Fuel Additives

### VALVTECT FUEL ADDITIVES

#### BioGuard™ Diesel Plus 6

Stabilizes fuel, improves performance, increases fuel economy and more.

Item	Model	Size/Treats	Fuel Type	Ship	Net
<b>305572</b>	<b>BGDP632</b>	32 oz./375 gallons	Diesel	3 lbs	<b>\$26.99</b>

### VALVTECT XP+ GASOLINE TREATMENT

• Helps prevent ethanol related problems • Stabilizes fuel for one year • Controls moisture and provides corrosion protection

Item	Model	Size	Ship	Net
<b>302041</b>	<b>XPGT04</b>	4 oz.	1 lbs	<b>\$5.99</b>
<b>302041</b>	<b>XPGT16</b>	16 oz.	1 lbs	<b>11.99</b>
<b>302041</b>	<b>XPGT32</b>	32 oz.	2 lbs	<b>21.99</b>

### AXI FUEL CATALYST

Dissolves tank sludge and slime, lowers fuel consumption, reduces harmful emissions, prevents corrosion of injectors and removes/prevents carbon buildup. 1 oz. treats 40 gallons. Preserves integrity of stored fuel up to 12 months. For gas/diesel/kerosene/HFO.

Item	Model	Size	Ship	Net
<b>302103</b>	<b>AFC-705</b>	8 oz.	1 lbs	<b>\$29.99</b>
<b>302103</b>	<b>AFC-705</b>	1 gallon	8 lbs	<b>194.99</b>

### STA-BIL® FUEL STABILIZER

• Keeps fuel fresh for up to 24 months during storage • Eliminates the need to drain fuel prior to storage • Ensures quick, easy starts after storage  
• Effective in all gasoline including ethanol blends • For all gasoline engines, including 2-cycle • 10 oz. treats 25 gallons, 32 oz. treats 80 gallons

Item	Model	Size	Ship	Net
<b>302110</b>	<b>GLD 22206</b>	10 oz.	1 lbs	<b>\$6.99</b>
<b>302110</b>	<b>GLD 22214</b>	32 oz.	2 lbs	<b>15.99</b>

### STA-BIL 360® MARINE™

• Vapor technology protects engine and fuel system above and below the fuel line  
• Helps prevent ethanol fuel related damage in boats  
• Enhanced water removal and helps prevent corrosion damage  
• Stabilizes fuel to keep it fresh during storage  
• Helps clean fuel system for improved in-season performance  
• Helps increase engine power and gas mileage  
• 1 oz. treats 10 gallons of fuel

Item	Model	Size	Ship	Net
<b>302109</b>	<b>22241</b>	10 oz.	1 lbs	<b>\$9.99</b>
<b>302109</b>	<b>22240</b>	32 oz.	2 lbs	<b>22.99</b>

### STA-BIL® DIESEL FORMULA FUEL STABILIZER AND PERFORMANCE IMPROVER

• Prevent sludge and sediment formation  
• Clean & lubricate entire fuel system • Protect against corrosion  
• Reduce oxidation of diesel fuel caused by thermal breakdown  
• Compatible with all ULSD & biodiesel blends  
• Size: 32 ounce bottle treats up to 320 gallons of diesel

Item	Model	Size	Ship	Net
<b>752471</b>	<b>22254</b>	32 oz.	3 lbs	<b>\$25.99</b>

### MDR WATER ZORB

Recombines water back into fuel allowing it to burn through safely. No need to drain tank. Prevents freeze-ups and improves engine performance. Contains no methanol or alcohol. For preventative maintenance. 1 oz. treats up to 18 gallons.

Item	Model	Size	Fuel Type	Ship	Net
<b>301634</b>	<b>MDR-567</b>	16 oz.	Gas	2 lbs	<b>\$17.99</b>
<b>301635</b>	<b>MDR-559</b>	16 oz.	Diesel	2 lbs	<b>18.99</b>

### MDR E-ZORB

Disperses and emulsifies water and ethanol back into the fuel allowing both to burn efficiently and safely. 1 oz. treats 20 gallons of 10% E-10 ethanol blended gasoline and will effectively prevent condensation from building up in your fuel tank. Contains no methanol or alcohol.

Item	Model	Size	Fuel Type	Ship	Net
<b>300047</b>	<b>MDR-574</b>	16 oz.	Gas	2 lbs	<b>\$21.99</b>

### TOHATSU GASOLINE FUEL STABILIZER - 8 OZ.

• Improves engine performance by keeping fuel fresh and the fuel system clean • For everyday use or long periods of storage • Works well in 2- and 4-cycle engines • Measuring cap for treating 1/2 or 1/4 oz. per gallon

Item	Model	Size	Ship	M.A.P.
<b>304043</b>	<b>332823200M</b>	8 oz. Bottle	1 lbs	<b>\$3.27</b>

### MERCURY QUICKKARE GASOLINE FUEL TREATMENT

• Designed for use with all octane grades and ethanol blend fuels each fill-up  
• Controls corrosion, moisture, build-up and phase separation  
• 12 ounce bottle treats up to 120 gallons of gasoline

Item	Model	Size	Ship	Net
<b>300688</b>	<b>8M0047930</b>	12 oz.	1 lbs	<b>\$9.99</b>

### MERCURY QUICKLEEN GASOLINE ENGINE TREATMENT

• Designed for use with all octane grades and ethanol blend fuels  
• Removes carbon deposits, prevents knocking and extends spark plug life  
• 12 ounce bottle treats up to 60 gallons of gasoline

Item	Model	Size	Ship	Net
<b>300687</b>	<b>8M0047931</b>	12 oz.	1 lbs	<b>\$10.99</b>



### Racor Turbine Series Heavy-Duty, High Capacity Filtration



Diesel-only model has see-thru bowl; gasoline or extra-heavy duty diesel uses metal bowl. Models which include an aluminum bowl or stainless steel shield meet ASTM FS1201 certification and are American Bureau of Shipping, Veritas, DET Norske Veritas, ISO 1088 and USCG accepted. Filter assembly available with 2 or 10 micron filters. 30 micron filters available separately. **Filter Assemblies**

Item	Model	Type	Ship	Net
300876	500FG2	See-thru bowl/diesel only, 60 GPH, 2 micron	5 lbs	\$204.99
301939	500MA	See-thru bowl w/ metal shield, diesel only, 60 GPH, <b>Specify 2 or 10 micron</b>	5 lbs	245.99
301936	500MAM	Diesel USCG approved/UL listed, 60 GPH <b>Specify 2 or 10 micron</b>	5 lbs	289.99
305043	75500FGX10	500 Series, dual, 120 GPH, 10 micron	17 lbs	809.99
305042	75500MAX2	500 Series, dual, 120 GPH, 2 micron	18 lbs	899.99
303052	900FH2	900 Series See-thru bowl/diesel only, 90 GPH	7 lbs	276.99
301940	900MA	See-thru bowl w/metal shield, diesel only, 90 GPH, <b>Specify 2 or 10 micron</b>	9 lbs	379.99
301937	900MAM	Diesel USCG approved/UL listed, metal bowl 90 GPH, <b>Specify 2 or 10 micron</b>	9 lbs	379.99
301024	1000FH2	See-thru bowl/diesel only, 180 GPH, 2 micron	9 lbs	299.99
301941	1000MA	See-thru bowl w/ metal shield, diesel only, 180 GPH, <b>Specify 2 or 10 micron</b>	12 lbs	398.99
301938	1000MAM	Diesel USCG approved/UL listed, 180 GPH <b>Specify 2 or 10 micron</b>	12 lbs	499.99

**Replacement Elements- Specify 2, 10 or 30 micron**

301942	2010	500 Series, 2.7" H x 3.1" Dia.	1 lbs	12.99
301981	2040N	900 Series, 4.6" H x 4.7" Dia.	1 lbs	13.99
301980	2020N	1000 Series, 9.6" H x 4.7" Dia.	1 lbs	15.99
300874	2000TM-OR	200 Series, 10 micron	1 lbs	16.99
300875	2000SM-OR	200 Series, 2 micron	1 lbs	16.99

NOTE: SM-OR = 2 Micron, TM-OR = 10 Micron, PM-OR = 30 Micron (OR means O-ring included)

### Racor Filter/Separators for Marine Gasoline Engines



Item	Model	Description	Ship	Net
306963	490R-RAC-01	Fuel filter/water separator with mounting head, spin-on element and see-thru clear bowl. 90 GPH,	3 lbs	\$106.99
301028	320R-RAC-01	Fuel filter/water separator with mounting head, spin-on element and see-thru Blue bowl. 60 GPH, 1/4" NPT ports. Outboard application only	3 lbs	82.99
301029	S3227	Replacement element for 490R-RAC-01, 320R-RAC-01, 10m	2 lbs	26.99
301030	320R-RAC-02	Fuel filter/water separator with mounting head, spin-on element and metal bowl. 60 GPH, 1/4" NPT ports. UL/USCG approved. Inboard or outboard applications	3 lbs	97.99
301031	S3228TUL	Replacement element for 320R-RAC-02, 10m	2 lbs	27.99
301032	B32013	Replaces Mercruiser Quicksilver #35-60494-1 Also fits: Yamaha, Suzuki, SMI and AquaPower filter heads. With see-thru bowl. Outboard applications only	2 lbs	46.99
301033	S3213	Replacement element for B32013	2 lbs	26.99
301034	B32014	Replaces OMC #174144, with see-thru bowl. Outboard applications only	2 lbs	47.99
301035	S3214	Replacement element for B32014	2 lbs	26.99
301036	B32020MAM	Replaces Mercruiser Quicksilver #35-60494-1. Also fits: Yamaha, Suzuki, SMI and AquaPower filter heads. With metal bowl. Inboard or outboard applications.	2 lbs	61.99
301037	S3220TUL	Replacement element for B32020MAM	1 lbs	28.99
301038	B32021MAM	Replaces OMC #174144, with metal bowl. Inboard or outboard applications	2 lbs	61.99
301039	S3221TUL	Replacement element for B32021MAM	1 lbs	31.99
303728	120R-RAC-01	Fuel-filter/water separator 30 GPH	2 lbs	76.99
303698	S3240	Replacement element for 120RRAC01, 10m	1 lbs	22.99
300108	06176-ZW3-80IAH	Honda spin on fuel filter/in-line to 5/16" hose. Flow rate of 25 GPH	1 lbs	74.99
304094	17670-ZW3-80IAH	Honda repl. element for 025-RAC-02	1 lbs	23.99

Racor fuel filters with clear bowls are not designed to be used in enclosed engine compartments. Use metal bowls in these locations.

❖ For more detailed product specifications and our complete selection visit [www.defender.com](http://www.defender.com) or call 800-628-8225. ❖



### Racor Compact Fuel Filter/Water Separators

Offering maximum protection in minimum space, this series features a variety of compact sizes to fit the most cramped compartments. All feature 1/4"-18 NPTF inlet and outlet fuel ports and a unitized mounting bracket for mounting versatility. Filtration options provide for a variety of micron ratings.

Item	Model	Type	Microns	Series	Replc Rate	Flow GPH	Size (H x Dia)	Ship	Net
301048	110A	Gas/Diesel	10	R11	35/15	6" x 3.2"	2 lbs	\$108.99	
301050	120AS	Diesel	2	R12	15	6.5" x 3.2"	2 lbs	94.99	
303509	230R2	Clear bowl 2 (Diesel ONLY)	2	R20	30	9" x 4"	3 lbs	125.99	

### REPLACEMENT ELEMENTS Ship 1 lbs

Item	Model	Type	Microns	Net	Item	Model	Model	Microns	Net
301049	R11T	110	10	\$19.99	302697	R15S	215	2	\$36.99
303699	R12P	120	30	22.99	300106	R15T	215	10	36.99
301052	R12T	120	10	22.99	303702	R24P	220	30	31.99
301051	R12S	120	2	22.99	301054	R24T	220	10	31.99
303701	R20P	230	30	28.99	301055	R24S	220	2	31.99
303700	R20T	230	10	28.99	301057	R26T	225	10	33.99
303697	R20S	230	2	28.99	301058	R26S	225	2	33.99

### SPIN-ON GASOLINE FILTER/WATER SEPARATOR For most inboard, outboard, 2 and 4-cycle gasoline engine applications. Measures 4-1/4" diameter x 4-1/4" tall.

Item	300000	Model	PFF5510	10 Microns	Ship 1 lbs	Net \$8.99
------	--------	-------	---------	------------	------------	------------



### RACOR DIESEL FILTER CHANGE INDICATOR

- T-Handle vacuum restriction indicator provides monitoring of filter
- Fits all Turbine Series fuel filter/water separator assemblies
- Monitors filter conditions as the filter becomes clogged



Item	Model	Fits Series	Ship	Net
300782	RK32348	500, 900, 1000	1 lbs	\$74.99



### RACOR RK19671 VACUUM GAUGE WITH STAINLESS STEEL T-HANDLE

- Applications: 500 (Post 2003) / 900 / 1000 Turbine Series diesel fuel filters
- Calibration: Vacuum -30 to 0 in/Hg
- Mount: 1/4" NPT thread, includes stainless steel T-handle



Item	Model	Ship	Net
306964	RK19671	1 lbs	\$95.99



### RACOR RK19669 VACUUM GAUGE

- Applications: 500 / 900 / 1000 turbine series diesel fuel filters
- Calibration: Vacuum -30 to 0 in/Hg
- Mount: 1/4" NPT thread (also works with T-handle)



Item	Model	Ship	Net
306967	RK19669	1 lbs	\$111.99



### RACOR FUEL FILTER BOWL REMOVAL WRENCH

- Racor fuel filter bowl removal wrench removes all metal and see-thru spin-on bowls that feature external ribs



Item	Model	Ship	Net
301536	RK 22628	1 lbs	\$26.99



### RACOR LIFEGUARD FUEL/AIR SEPARATOR

It efficiently separates air from fuel forced into the line and captures fuel normally discharged due to agitation and thermal expansion up to 2.4 psi. One is required for each fuel vent line. 5/8" line size.



Item	Model	Ship	Net
301044	LG100	2 lbs	\$104.99



### GROCO GASOLINE OR DIESEL FUEL REPLACEMENT FILTER

For Groco model GF-375 fuel filter for gasoline or diesel. Comes with O-ring. Item 301064 GF-376 Ship 1 lbs Net \$47.99

### Moeller Inboard & Outboard Water Separating Kits & Filters



### REPLACEMENT WATER SEPARATING GAS FILTER AND BOWL KIT-OUTBOARD

Clear Site™ water separating fuel filter system for outboard engines - includes composite filter head, hose barsbs, fuel filter and clear water collecting bowl. 10 micron filter. Recommended for ethanol blended fuels.



Item	Model	Ship	Net
300005	033314-10 Kit	2 lbs	\$56.99
303379	033315-10 Filter only	1 lbs	22.99



### FUEL/WATER SEPARATOR BONUS PACK -OUTBOARD

- Includes (2) 10 micron filters and (1) composite filter head
- 3/8" NPT hi-flow ports
- Hose 3/8" NPT barbs and plugs



Item	Model	Ship	Net
300498	033322-10	5 lbs	\$39.99



### WATER SEPARATING FUEL FILTER KIT

- 3/8" NPT for Universal applications/Mercury/Yamaha
- Cast aluminum powder coated
- Kit includes barbs, canister and filter head



Item	Model	Ship	Net
304301	033320-10	2 lbs	\$35.99

### REPLACEMENT FILTERS FOR MODELS 033322-10 AND 033320-10

Item	Model	Description	Ship	Net
304302	033323-10	Mercury/Universal, long style	1 lbs	\$12.99
300557	033324-10	Mercury/Universal, short style	1 lbs	10.99
304303	033325-10	OMC (Johnson/ Evinrude/BRP)	1 lbs	11.99



## Electric Oil Changers

### JABSCO OIL CHANGER PUMP

Versatile means of transferring fluid using an electric drill with 1/4" to 3/8" chuck. Includes pump with garden hose adapters and 1/4" x 40" probe plus 3 ft. of 1/2" hose for changing oil through a dip stick tube. 3.5 GPM. Self-priming.



Item	Model	Description	Ship	Net
300044	17215-0000	1/4" diameter shaft	1 lbs	\$43.99

### JABSCO SELF-CONTAINED FLAT TANK OIL CHANGING SYSTEM

- Capacity: 3.5 gallon / 14 quart • Self-priming
- Power: 12 VDC, Draw: 4 A
- Includes 6' battery clamp wire leads and on/off pump switch
- Flat tank design allows for easy storage in deck boxes and boat storage lockers



Item	Model	Ship	Net
756338	17860-2012	9 lbs	\$161.99

### JABSCO ECONOMY 3-1/2 GALLON ENGINE OIL CHANGER

- Extracts up to 50 weight oil through the dip stick tube
- Powerful suction pump with integral on/off switch
- 8 ft. power leads with color coded alligator clips
- 8 ft. heat resistant Teflon™ dip stick probe



Sheathing over the power cord is not included

Item	Model	Voltage	Ship	Net
300080	17850-1012	12 VDC	7 lbs	\$156.99

### JABSCO PREMIUM PORT-A-QUICK OIL CHANGER

- Robust, reversible bronze pump
- Removes oil sludge through the dip stick tube
- Includes 8' cord, tubes, connectors, 14 qt. tank and terminals
- Suction Hose: 4' of neoprene hose with 40" PTFE dipstick probe

Item	Model	Voltage	Ship	Net
301553	17800-2000	12 VDC	12 lbs	\$232.99

## Manual Oil Changers & Fluid Extractors

### MARPAC PORTABLE FLUID EXTRACTORS

- Empties in 16 pumps or fewer • No power source needed
- Warm or cold fluid extraction • Includes extraction tube kit

Item	Model	Capacity	Ship	Net
300280	7-0950	1.70 gallon	7 lbs	\$71.99
300290	7-0951S	1.05 gallon	6 lbs	62.99

### JABSCO PAR LITTLE PAL PUMP

Uses include bilge pumping, oil draining, diesel fuel transfer, and many other liquid transfer applications. Includes 2' of 1/2" hose and 40" of 1/4" hose. Not for fuel!

Item	Model	Length	Dia.	Per Gal.	Ship	Net
500786	34060-0010	10'-1/4"	1-1/4"	40	1 lbs	\$54.99

### JABSCO PAR HANDY BOY PUMP

Ideal for engine crankcase pump-out, bilge pump or as air pump. Includes 3' of 1/2", 40" of 5/16" and 40" of 1/4" hose, neoprene adapter and connector. Not for fuel!

Item	Model	Length	Dia.	Per Gal.	Ship	Net
500823	33799-0000	12"	1-1/4"	26	2 lbs	\$81.99

### MOELLER FLUID EXTRACTOR PUMP

- Pumps with both upstroke and downstroke
- Power: Manual — no electric or air power required
- Suitable for most fluid extractions EXCEPT gasoline

Item 300947	035330	1.32 gal.	Ship 6 lbs	Net \$75.99
Item 300948	035340	1.85 gal.	7 lbs	98.99

### MOELLER FLUID EXTRACTOR MANUAL / PNEUMATIC

- Capacity: 15 liter (3.96 gallon)
- Automatic operation: hand pump or shop air
- Use to extract non-explosive fluids such as oil, brake fluid, coolant, water, etc.
- Air inlet: 1/4"

Item 301117	Model 035360	Ship 10 lbs	Net \$152.99
-------------	--------------	-------------	--------------

## Oil Absorbers

### ABSORBERS BILGE OILZORB

- Absorbs up to 4 quarts of oil, repels water • Mesh design permits full saturation
- Will not mildew or disintegrate • Floats indefinitely; dispose when filled with oil

Item	Model	Size	Ship	Net
301640	MDR-755	4" dia. x 15"	1 lbs	\$13.99

### 3M™ OIL SORBENT SHEETS

- Soaks up oil and gasoline but repels water
- White pad has 1.4 liters capacity (1.5 quarts)

Item	Model	L x W x H	Ship	Net
754252	HP156	17" x 19" x 1/4"	1 lbs	\$1.89

### REVERSO REVERSIBLE OIL CHANGE PUMPS

- Self-priming • IP67 rated
- Includes 3/4" male garden hose fitting
- Reversing switch • Size: 7.57" x 3.5" x 5.16"

Please specify voltage: 12 VDC (Draw: 8 A) or 24 VDC (Draw: 4 A)

Item	Model	Description	Ship	Net
756679	OP-7	7.4 GPM, Ports: 3/4" male, 3/8" female NPT	5 lbs	\$236.99
302068	38-2410	Viton replacement impeller for OP-7	1 lbs	25.99
302069	38-2420	Repair kit for OP-7	1 lbs	39.99

### Light Duty Pump with reversible on/off switch

Please specify voltage: 12 VDC (Draw: 8 A) or 24 VDC (Draw: 4 A)

301519	GP-311R	3 GPM, Ports: 3/8" male NPT	5 lbs	\$299.99
--------	---------	-----------------------------	-------	----------

### REVERSO SERIES REVERSIBLE/PORTABLE OIL CHANGING SOLUTIONS

- Designed for the convenience of quick and easy maintenance
- Self-priming: 5 ft / 1.5m (wet gears)
- Pump body: Brass
- Gears: Bronze

Item	Model	Description	Ship	Net
12 VDC Portable/reversible oil change system with bucket top base				
305507	GP-311BKT-01	3 GPM, Ports: 3/8" male JIC, reversible flow, with alligator clips	8 lbs	\$339.99

### 12 VDC Portable/reversible oil change system with marine base

305506	GP-311P	3 GPM, Ports: 3/8" male JIC, reversible flow; with alligator clips	8 lbs	370.99
--------	---------	--------------------------------------------------------------------	-------	--------

### REVERSO REVERSIBLE, SELF-PRIMING OIL CHANGE SYSTEMS

Specify voltage: 12 VDC or 24 VDC  
Flow Rate

Item	Model	GPM	Valves	Ship	Net
305503	GP-3013	2.5	3	10 lbs	\$530.99
305504	GP-3015	2.5	5	13 lbs	573.99
305505	GP-3025	3	5	16 lbs	663.99

## Engine Flushers

### REVERSO AUTOMATIC OUTBOARD FLUSHING SYSTEM VERSION 2.0

Permanently-installed system flushes all outboard engines automatically in a sequence. After a single hose connection, and one press of a button, the system will flush one engine at a time. The system shuts down after all flushing cycles are complete. Designed for outboard engines. Not compatible with I/O engines.

Item	Model	Description	Ship	Net
302440	35-3862-01	2 engine setup, 12V	4 lbs	\$748.99
	35-3863-01	3 engine setup, 12V	4 lbs	813.99

### REVERSO HOSE FITTING KIT FOR AUTOMATIC OUTBOARD FLUSHING SYSTEM

Fittings included for inlet: 3/4" straight and 90° elbow fitting  
Fittings included for outlets: 3/8" hose barb straight and 90° elbow fitting, 1/2" hose barb straight and 90° elbow fitting (recommended for engines 300HP or more)

Item	Model	Description	Ship	Net
302441	35-3955-02	2 engine setup	1 lbs	\$51.99
	35-3955-03	3 engine setup	1 lbs	61.99

### GROCO ENGINE FLUSH KIT

Add to the top of any seacock to allow instant emergency bilge pumping or to simplify winterization and cooling system flushing. Service adapter included.  
Specify hose ID: 3/4", 1", 1-1/4", 1-1/2", 2", 2-1/2" or 3"

Item 756500	Starting at \$79.99
-------------	---------------------

### SALT-AWAY COMBO KIT BIODEGRADABLE!

For flushing salt out of the cooling systems of outboards, inboards, I/Os and personal watercraft. Prevents salt build-up inside the engine before overheating can begin — provides long-lasting corrosion protection.

- Mixer unit connects to garden hose on one end and engine flusher on the other end and dilutes the concentrate

Item	Model	Description	Ship	Net
Ⓞ 753085	SA32M	Salt-Away kit (32 oz. concentrate and mixer unit)	3 lbs	\$39.99
Ⓞ 753086	SA128	128 oz. concentrate refill (mixer unit sold separately)	10 lbs	37.99
Ⓞ 753084	SA32	32 oz. concentrate refill (mixer unit sold separately)	3 lbs	14.99
Ⓞ 753083	SA16	16 oz. professional strength spray	2 lbs	12.99
753087	SAM	3 position mixing unit (Off-Rinse-Salt Away)	1 lbs	34.99

### MOELLER FLUSHRITE MOTOR FLUSHERS



Flush contaminates from your lower unit cooling systems. Quickly remove salt and mineral build-up with a simple flush that slips over side water inlets on most inboard and outboard lower units. Install in seconds using just a garden hose.

Item	Model	Description	Ship	Net
300185	099076-00	Universal round cup	1 lbs	\$6.99
300186	099077-00	Universal rectangular cup	2 lbs	9.99
300187	099080-00	Volvo round cup	1 lbs	13.99
300188	099082-00	Dual feed rectangular cup	2 lbs	29.99
305658	380160	Professional, Dual water feed	2 lbs	34.99



**VDO Marine Line**

Reliable, durable and accurate!

**VISION SERIES**

- Economical choice for a wide range of applications for both outboards and inboards
- Polished chrome or Black bezel
- VDO patented movements
- Tri-optic through-dial illumination
- Spin Lok™ mounting system

**ALLETARE SERIES**

- Offer excellent illumination, accuracy and easy installation
- An ideal, cost effective solution for new boats or drop-in replacements
- Designed to work with most commonly found marine senders and wiring harnesses
- Features all of the craftsmanship and quality that marine professionals and consumers alike expect from the VDO brand



**Allentare Black/Chrome**

**Vision Black**

**Vision Chrome**

**Viewline Onyx**

**Viewline Ivory**

**VIEWLINE SERIES**

- The most anti-fog and water-resistant gauge in the market today - IP67 rated
- Complete through dial LED illumination, including the pointer
- Sealed dual lens
- LED light dual voltage: 12-24 VDC in all gauges
- Reverse polarity and over voltage protection
- Built in OEM style connectors and harness pig tail
- Tested to 25G continuous vibration and 100G shock
- Built in warning light in all gauges
- Anti corrosion materials
- Stepper motor technology
- Spin Lok mounting system
- Optional bezels at [www.defender.com](http://www.defender.com)

All ship 1 lbs

	Allentare Black/Chrome	Gauge Diameter	Net	Vision Black	Gauge Diameter	Net	Vision Chrome	Gauge Diameter	Net	Viewline Onyx	Gauge Diameter	Net	Viewline Ivory	Gauge Diameter	Net
<b>FUEL GAUGES</b>															
Fuel 240-33 OHM, optional sender required	305900	2-1/16"	\$28.99	300981	2-1/16"	\$36.99	304479	2-1/16"	\$36.99	305405	2-1/16"	\$47.99	305410	2-1/16"	\$48.99
Fuel 10-184 OHM, optional 3-180 OHM sender required				300980	2-1/16"	36.99	304478	2-1/16"	34.99	305404	2-1/16"	48.99	305409	2-1/16"	49.99
Fuel F/VDO TUBE, optional sender required				304516	2-1/16"	37.99	304480	2-1/16"	37.99	305407	2-1/16"	48.99	305412	2-1/16"	49.99
Fuel w/Alas 1 sender				304525	2-1/16"	86.99	304481	2-1/16"	86.99	305403	2-1/16"	89.99	305408	2-1/16"	89.99
Sender only 240-33 OHM				305014		For tanks 6-15.75" deep	36.99	305011		For tanks 6.75-23" deep		48.99			
Sender only 3-180 OHM				305013		For tanks 6-15.75" deep	36.99								
<b>TACHOMETERS</b>															
Tach 3000 RPM				304503	3-3/8"	\$124.99	304458	3-3/8"	\$98.99	304798	3-3/8"	\$143.99	304803	3-3/8"	\$145.99
Tach/Hour 3000 RPM				304496	3-3/8"	149.99	304455	3-3/8"	148.99	304814	3-3/8"	178.99	304818	3-3/8"	183.99
Tach 4000 RPM	305897	3-3/8"	\$97.99	304502	2-1/16"	124.99				304797	3-3/8"	141.99	304802	3-3/8"	145.99
Tach/Hour 4000 RPM				304495	3-3/8"	149.99	304454	3-3/8"	148.99	304813	3-3/8"	178.99	304817	3-3/8"	181.99
Tach 6000 RPM	305897	3-3/8"	97.99	304501	2-1/16"	124.99				304796	3-3/8"	142.99	304801	3-3/8"	145.99
Tach/Hour 6000 RPM										304812	3-3/8"	185.99	304816	3-3/8"	185.99
<b>SPEEDOMETERS</b>															
35 MPH	305896	3-3/8"	\$65.99												
60 MPH	305896	3-3/8"	65.99												
<b>SUMLOG</b>															
60 MPH with odometer, clock, voltmeter										304822	3-3/8"	\$230.99	304823	3-3/8"	\$230.99
<b>WATER PRESSURE</b>															
Max. pressure: 40 PSI, sender sold separately	305903	2-1/16"	\$46.99												
<b>WATER TEMPERATURE</b>															
250° F use w/VDO sender, sender required, sold separately	305899	2-1/16"	\$28.99	300977	2-1/16"	\$38.99				305360	2-1/16"	\$48.99	305380	2-1/16"	\$48.99
250° F w/sender and metric thread adapters				304483	2-1/16"	59.99	304442	2-1/16"	59.99	305359	2-1/16"	72.99	305379	2-1/16"	65.99
250° F w/sender and US thread adapters				304482	2-1/16"	59.99	304441	2-1/16"	59.99	305358	2-1/16"	72.99	305363	2-1/16"	72.99
Sender only 250° F temp sender				300964		18.99	300965		17.99						
Sender only 250° F temp sender kit w/US thread adapters				304529		23.99									
<b>OIL PRESSURE</b>															
80 psi 10-180 OHMs, optional sender required				300968	2-1/16"	\$38.99	304463	2-1/16"	\$39.99	305385	2-1/16"	\$48.99			
80 psi 240-33 OHMs, optional sender required	305898	2-1/16"	\$28.99				304464	2-1/16"	33.99	305370	2-1/16"	49.99	305393	2-1/16"	\$49.99
80 psi w/sender and metric thread adapters				304509	2-1/16"	79.99	304466	2-1/16"	77.99	305384	2-1/16"	96.99	305372	2-1/16"	107.99
80 psi w/sender and US thread adapters				304508	2-1/16"	79.99	304465	2-1/16"	77.99	305383	2-1/16"	97.99	305371	2-1/16"	106.99
Sender only 240-33 OHM				305007	*	41.99									
Sender only 10-180 OHM w/US adapters				304526	*	58.99									
Sender only 10-180 OHM floating ground				300959	*	50.99									
Sender only 10-180 OHM dual station				300960	*	43.99									
<b>TRIM</b>															
Analog, sender required, sold separately Specify ohm range 0-90 or 10-180	305901	2-1/16"	\$28.99												
<b>VOLTMETER</b>															
12 VDC	305902	2-1/16"	\$28.99	300975	2-1/16"	\$37.99	304445	2-1/16"	\$42.99	304720	2-1/16"	\$51.99	304722	2-1/16"	\$51.99
24 VDC				304484	2-1/16"	38.99	304444	2-1/16"	42.99	304719	2-1/16"	50.99	304721	2-1/16"	52.99





## Marine Instruments & Accessories



	Euro Black			Dress White			Chesapeake White SS			Chesapeake Black SS			Kronos Aluminum SS		
	Item	Ship	Net	Item	Ship	Net	Item	Ship	Net	Item	Ship	Net	Item	Ship	Net
Fuel Level E-1/2-F, 2" dia.	304353	1	\$23.99	304549	1	\$24.99	304538	1	\$29.99	301898	1	\$29.99	305939	1	\$29.99
Oil Pressure, 80 psi, 2" dia.	304355	1	23.99	304551	1	24.99	304539	1	29.99	301888	1	29.99	305940	1	29.99
Water Pressure, 60 psi, 2" dia.	304356	1	49.99										305941	1	51.99
Speedometer, 80 MPH Mech, 4" dia.	304359	1	44.99	304555	1	44.99	304537	1	50.99						
Tachometer 7000 Universal O/B, 4" dia.	304360	1	69.99	304558	1	69.99	304533	1	84.99	301883	1	84.99	305937	1	89.99
Tach/Hour 4000 Diesel Mech, 4" dia.	304361	1	115.99				304535	1	124.99						
Tach/Hour 7000 Universal O/B, 4" dia.	304362	1	115.99	304556	1	99.99	304534	1	115.99						
Tachometer 4000 Diesel Mech, 4" dia.	304363	1	72.99												
Water Temp 100-250°F, 2" dia.	304364	1	23.99	304559	1	24.99	304541	1	29.99	301890	1	29.99	305942	1	29.99
Trim Gauge, Mercury, Volvo, Yamaha, 2" dia.	305976	1	23.99	305975	1	24.99	305974	1	29.99	305973	1	29.99	305943	1	33.99
Trim Gauge J/E Suzuki, 2" dia.	304365	1	23.99	304560	1	24.99	304543	1	29.99	301892	1	29.99			
Voltmeter 10-16 VDC, 2" dia.	304368	1	23.99	304563	1	24.99	304548	1	29.99	301897	1	29.99	305944	1	29.99
Ammeter, 60-0-60, 2" dia.	304370	1	23.99							301894	1	28.99			
Hourmeter, 12/24/32 VDC, 2" dia.	306511	1	39.99				306509	1	49.99	306510	1	49.99			
6-Gauge instrument set (Inboard)	300281	5	179.99	300281	5	179.99	300283	5	199.99	300283	5	199.99			
4-Gauge instrument set (Outboard)	300282	4	159.99	300282	4	159.99	300288	4	159.99	300288	4	159.99			
GPS Speedometer, 4", up to 60 MPH	306097	1	99.99				305978	1	99.99	305977	1	99.99			

2" actual bezel diameter 2-1/4", 2-1/16" cutout. 4" actual bezel diameter 4", 3-3/8" cutout

### SENDERS & ACCESSORIES

Item	Model	Description	NPT	Temp Range	Ship	Net
	90401	Temp sender	1/8"	100-220°F	1 lbs	\$15.99
302135	90402	Temp sender	1/4"	100-220°F	1 lbs	16.99
	90403	Temp sender	3/8"	100-220°F	1 lbs	18.99
	90404	Temp sender	1/2"	100-220°F	1 lbs	19.99

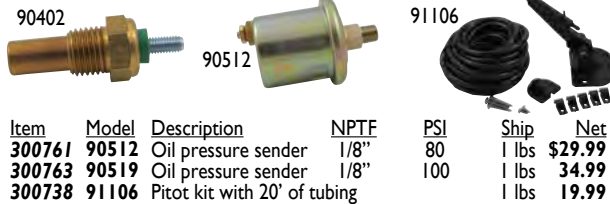

Item	Model	Description	NPT	PSI	Ship	Net
300761	90512	Oil pressure sender	1/8"	80	1 lbs	\$29.99
300763	90519	Oil pressure sender	1/8"	100	1 lbs	34.99
300738	91106	Pitot kit with 20' of tubing			1 lbs	19.99

### Faria Boxed Sets



**CHESAPEAKE SS BLACK 6-GAUGE INBOARD SET**  
 4" GPS Speedometer (60 MPH)  
 4" Tachometer (6000 RPM)  
 2" Fuel level  
 2" Voltmeter (10 - 16 Volt DC)  
 2" Water temp (100 - 250°F)  
 2" Oil pressure (80 PSI)  
 Item 305979 Net \$249.99

**CHESAPEAKE SS WHITE 6-GAUGE INBOARD SET**  
 4" GPS Speedometer (60 MPH)  
 4" Tachometer (6000 RPM)  
 2" Fuel level  
 2" Voltmeter (10 - 16 Volt DC)  
 2" Water temp (100 - 250°F)  
 2" Oil pressure (80 PSI)  
 Item 305981 Net \$249.99

**KRONOS 6-GAUGE INBOARD SET**  
 4" Mech. Speedometer (60 MPH)  
 4" Tachometer (6000 RPM)  
 2" Fuel level  
 2" Voltmeter (10 - 16 Volt DC)  
 2" Water temp. (100-250°F)  
 2" Oil pressure (80 PSI)  
 Item 305935 Net \$199.99



	Omega				Arctic				Eclipse				Heavy Duty			
	Item	Model	Ship	Net	Item	Model	Ship	Net	Item	Model	Ship	Net	Item	Model	Ship	Net
Fuel Gauge, 2" dia.	303938	57902P	1	\$25.99	304387	68365P	1	\$25.99	304407	68390P	1	\$25.99	300507	80150P	1	\$27.99
Hourmeter 10,000 hrs, 2" dia.	303940	84760P	1	46.99	304388	68366P	1	46.99	304408	68391P	1	46.99	300508	82760P	1	56.99
Oil Pressure Gauge (SW) 0-80 psi, 2" dia.	303939	57903P	1	25.99	304389	68367P	1	25.99	304409	68392P	1	25.99	300509	80180P	1	28.99
Water Pressure Kit (Outboard) 40 psi, 2" dia.	300321	68357P	1	57.99	304390	68369P	1	57.99	304410	68394P	1	57.99				
Speedo Kit 35 MPH (Pitot Type), 3" dia.	304104	58342P	1	50.99	300417	68370P	2	50.99	300451	68395P	2	50.99				
Speedo Kit 60 MPH (Pitot Type), 3" dia.													300510	80514P	1	61.99
Speedo Kit 65 MPH (Pitot Type), 3" dia.	303937	57900P	1	50.99	304391	68371P	1	50.99	304411	68396P	1	50.99				
Tachometer 0-7000 RPM O/B and 4-Cycle Gas 3" dia.	303936	58255P	1	70.99	304392	68374P	1	70.99	304412	68399P	1	70.99				
Tachometer 0-4000 RPM Diesel Alt, 3" dia.					304393	68373P	1	70.99	304413	68398P	1	70.99	300511	82302P††	1	89.99
Tach/Hour 0-7000 RPM O/B and 4-Cycle Gas, 3" dia.					304394	68375P	1	107.99	304414	68400P	1	107.99				
Water Temp (SW) 120-240°F, 2" dia.	303996	57904P	1	25.99	304395	68376P	1	25.99	304415	68401P	1	25.99	300512	80590P	1	27.99
Water Temperature Kit (Outboard), 2" dia.	303995	58862P*	1	54.99	304396	68377P	1	54.99	304416	68402P	1	54.99				
Trim Gauge Evinrude/Johnson, 2" dia.	303942	58431P	1	25.99	304397	68378P	1	25.99	304417	68403P	1	25.99				
Trim Gauge Honda, 2" dia.	300322	68359P	1	71.99	304398	68379P	1	71.99	304418	68404P	1	71.99				
Trim Gauge Newer Yamaha, 2" dia.	303941	57905P	1	25.99	304399	68380P	1	25.99	304419	68405P	1	25.99				
Trim Gauge pre 2001 Yamaha outboards, 2" dia.					304400	68381P	1	27.99	304420	68406P	1	27.99				
Voltmeter 12 VDC, 2" dia.	303943	57901P	1	25.99	304401	68383P	1	25.99	304421	68408P	1	25.99	300513	80134P †	1	28.99
Voltmeter 24 VDC, 2" dia.													300514	80131P	1	38.99
System Check Gauge - Evinrude/Johnson, 2" dia.	300323	65205P	1	103.99	304402	68385P	1	100.99	304422	68410P	1	100.99	300515	80710P	1	29.99
Ammeter, 2" dia.	300324	68356P	1	27.99					304424	68389P	1	27.99				
4 Gauge Kits (Outboard)	300325	68362P*	3	139.99	304405	68387P*	4	137.99	304144	68412P*	3	137.99				
6 Gauge Kits (I/O or Stern Drive)	300326	68363P**	1	175.99	304406	68388P**	4	173.99	304145	68413P**	4	173.99				

Sierra 2" actual bezel diameter 2.38", cutout 2.08". Sierra 3" actual bezel diam 3.78", cutout 3.4"

\* **Outboard kit** - Tachometer, speedometer (With pitot tube) fuel gauge (Compatible with common marine senders) and voltmeter. Matching trim gauges, hourmeters and water pressure or temperature kits are available separately. (Not for diesels) **Note:** Adapter (P/N 61886P) is required for Yamaha.

\*\* **Stern drive kit** - Tachometer, speedometer (With pitot tube), fuel gauge, water temperature gauge, oil pressure gauge (All compatible with common marine senders), and voltmeter. Matching trim gauges and hourmeters are available separately for stern drive applications. (Not for diesels)

### SENDING UNITS

Item	Model	Description	Ship	Net
302810	56973P	Pitot tube, 30-80 MPH speedometers	1 lbs	\$8.99
302813	90424P	Fuel sender, 4-24" tank depth	1 lbs	34.99
302818	OP24891	80 psi dual station oil pressure sending unit	1 lbs	27.99

### UNIVERSAL HOURMETER

Waterproof universal hourmeter: track engine operating hours anywhere onboard for routine maintenance. Clean universal styles complement any cockpit or engine compartment. Includes mounting hardware and instructions. Black with White graphics. All ship 1 lbs.



Item	Model	Description	Net
302811	56967P	Rectangular, fits 1-1/2" x 1" cutout	\$39.99
303960	56966P	Round, fits 2-1/8" diameter cutout	39.99

### Reverso Fuel Polishing Module



- Module is easy to install and turns any filter into a comprehensive fuel polishing system
- Works with most standard filters
- Compatible with middle-distillate fuels and fuel oils (not gasoline)
- For an initial cleaning, it is recommended you turn the fuel 3 times. Once in maintenance mode, you can perform this cleaning once a week. Continuous use is not required

**Specifications:**

- Flow rate: 2.6 GPM / 10 LPM
- Ports: 1/2" hose barb
- Self-priming: 5 ft / 1.5 m (wet gears)
- Max work pressure: 50 psi / 3.5 bar
- Max work temperature: 140 F / 60 C
- Maximum suction lift: 5 ft.
- Total discharge head not to exceed 30'
- Width 12" x Height 8.7" x Depth 4.4"

Please Specify: 12 or 24 VDC

Item	Ship	Net
305492	14 lbs	\$849.99



### Reverso Marine Diesel Fuel Polishing System with Digital Timer

- Eliminates sludge and water buildup in the tank
- 99.9% water separation
- 99% particulate removal
- Equipped with metal heat deflector
- Shutdown and alarm for high vacuum and water

**Specifications:**

- Inlet: 1/2" #8 JIC male
- Outlet: 1/2" #8 JIC male
- Pump body: Brass
- Gears: Bronze

Please Specify: 12 or 24 VDC

Item	Flow	Amps	Max Lift	Ship	Net
D 305500	80 GPH	2.7A @ 12 VDC, 1.4A @ 24 VDC	4' Vert.	42 lbs	\$1611.99
D 305501	150 GPH	10A @ 12 VDC, 5A @ 24 VDC	10' Vert.	42 lbs	1910.99
305502	210 GPH	3A @ 120 VAC, 1.2A @ 24 VDC	30' Vert.	61 lbs	S/A 2899.99



- Shaft: Stainless Steel

### TK-240-XT Mobile Fuel Polishing System

Used for re-circulating, polishing and transferring diesel fuel and light oils in boats, stand-by generators and heavy equipment. The TK-240-XT can be used in conjunction with the existing on-board primary filter/water separator. The TK-240-XT effectively removes water and sludge from the bottom of tanks and transfers waste to an appropriate waste receptacle. **Kit includes:** • Nickel-plated brass gear pump • LG-X 500 fuel conditioner • 15 micron water block cartridge • Pressure gauge • Inline strainer • Specially designed spill tray • Suction and discharge hoses and clamps • Filter wrench • 8 oz. bottle of AFC-705

Item	Model	Flow	Port	Power	Dimensions	Ship	Net
300943	240-XT	240 GPH	1/2"	12 VDC, 10A	13" x 12" x 22"	30 lbs	\$1324.99



### Magnetic In-Line Fuel Conditioner

- Cleans fuel injection systems, filters and tanks
- Lowers harmful emissions and fuel consumption
- Reduces maintenance and downtime
- Eliminates and prevents carbon deposits
- Lowers operating cost

Item	Model	Port Size	Flow Rate	Max HP	Ship	Net
300036	LG-X 200	1/4"	1-25 GPH	200	1 lbs	\$154.99
300038	LG-X 500	1/2"	20-110 GPH	500	2 lbs	274.99
300039	LG-X 1500	3/4"	50-350 GPH	1500	5 lbs	454.99

For more detailed product specifications and our complete selection visit [www.defender.com](http://www.defender.com) or call 800-628-8225.

### Sen-Dure Heat Exchanger Repair Kits

Item	Description	Ship	Net
302039	2" Heat exchanger end cover assembly (end plate, gasket, washer, bolt)	1 lbs	\$13.99
	3" Heat exchanger end cover assembly (end plate, gasket, washer, bolt)	1 lbs	18.99
	4" Heat exchanger end cover assembly (end plate, gasket, washer, bolt)	1 lbs	29.99
	5" Heat exchanger end cover assembly (end plate, gasket, washer, bolt)	1 lbs	32.99
	6" Heat exchanger end cover assembly (end plate, gasket, washer, bolt)	3 lbs	95.99

Item	Description	Ship	Net
300910	2" Rubber gasket for heat exchanger end covers and flanges	1 lbs	\$3.99
300911	3" Rubber gasket for heat exchanger end covers and flanges	1 lbs	3.99
300912	4" Rubber gasket for heat exchanger end covers and flanges	1 lbs	3.99
300913	5" Rubber gasket for heat exchanger end covers and flanges	1 lbs	4.99
300902	6" Rubber gasket for heat exchanger end covers and flanges	1 lbs	8.99
300903	3/16" Gum rubber washer for 2" round end covers	1 lbs	2.99
302156	Rubber washer for 3", 4" and 5" round end covers, 3/8" ID, 5/8" OD	1 lbs	2.99

Contact Sen-Dure for help in product selection and model number: Sen-Dure Products, Inc. • 800-394-5112 • [www.sen-dure.com](http://www.sen-dure.com) Contact Defender at 800-628-8225 to order all your parts at a discount price.

### PSS DRIPLESS SHAFT SEALS

- Dripless, maintenance-free stuffing box replacement system
- Installed as standard equipment by many quality manufacturers
- 3/4" to 6" (22 mm - 150 mm) sizes available - call for prices!

Round down to nearest 1/4"

Item	Shaft Size"	Specify Stern Tube Dia."	Ship	M.A.P.
301222	1.0	1.25, 1.5, 1.75, 2 or 2.25	2 lbs	\$248.00
301224	1.125	1.25, 1.5, 1.75, 2 or 2.25	2 lbs	248.00
301226	1.25	1.75, 2, 2.25, or 2.5	3 lbs	284.00
301228	1.375	1.75, 2, 2.25, or 2.5	4 lbs	284.00
301230	1.5	2.0, 2.25, 2.5, 2.75, 3, 3.25 or 3.5	4 lbs	
301232	1.75	2.25, 2.5, 2.75, 3, 3.25, or 3.5	5 lbs	412.00
301234	2.0	2.5, 2.75, 3, 3.25, or 3.5	6 lbs	484.00



Shaft Seal Maintenance kits available at defender.com

### FLAX PACKING EXTRACTOR TOOL

- Manufactured by Western Pacific Trade
- Size #0 shaft-length 9", Size #1 shaft-length 12.5"

Item	Size	Ship	Net	Item	Size	Ship	Net
755408	#0	1 lbs	\$7.99	755409	#1	1 lbs	\$8.99



### TEFLON™ PTFE FLAX SHAFT PACKING

PTFE flax packing is braided from quality flax rovings which are impregnated with TEFLON (PTFE) producing a quality packing that offers high performance and extended packing life. Length 24"

Item	Flax"	Ship	Net	Item	Flax"	Ship	Net
755404	1/8	1 lbs	\$4.99	755406	1/4	1 lbs	\$6.99
755405	3/16	1 lbs	5.99	755407	5/16	1 lbs	7.99



### BUCK ALGONQUIN PACKING BOX WRENCH

- Fits rudder ports and packing boxes
- Made from zinc plated iron

Item	Opening Size	Overall Length	Shaft Size	Ship	Net
301235	2"	9"	1 & 1-1/8"	2 lbs	\$36.99
301236	2-5/16"	9-1/4"	1-1/4"	2 lbs	36.99
301237	2-9/16"	9-1/2"	1-3/8 & 1-1/2"	3 lbs	38.99
301238	3-1/4"	10-1/2"	1-3/4 & 2"	3 lbs	44.99
301239	3-13/16"	15-1/2"	2-1/4 & 2-1/2"	5 lbs	59.99



### GRAPHTEX ULTRA (GTU) FLAX SHAFT PACKING - 24" LENGTH

A unique blend of W.L. Gore fibers and graphite fibers that are impregnated with Teflon PTFE. This produces a packing that is thermal, conductive, strong and durable. Heat is dissipated away from the stuffing box. All ship 1 lbs.

Item	Flax"	Net	Item	Flax"	Net	Item	Flax"	Net	Item	Flax"	Net
755400	1/8	\$6.99	755402	1/4	\$15.99	755386	3/8	\$31.99	755388	1/2	\$43.99
755401	3/16	11.99	755403	5/16	19.99	755387	7/16	33.99	755389	5/8	62.99

### DRIPLESS SHAFT PACKING

A unique, clay-like material that molds to the inside of the stuffing box, creating a permanently-lubricated seal. Properly installed, it completely seals off the shaft log to outside water. Wears slowly and lasts several seasons. **Not suitable for boats with extremely fast shaft rotation.**

Item	Shaft Dia.	Ship	Net	Item	Shaft Dia.	Ship	Net
303726	Up to 1-1/2"	1 lbs	\$63.99	303727	Up to 3"	1 lbs	\$85.99

To determine if your shaft rotation exceeds the limitations of this product, use the following formula: Shaft size x 3 x max. shaft RPM (not engine RPM) ÷ 12 = max. FPM. max. FPM should not exceed 900 Max.

### Morse Marine Brass Sleeved Shaft Bearings

- Pollution-free naval brass
- Rubber lined and water lubricated
- Requires no seals and no oil or grease for lubrication
- Locked in place with cone-pointed set screws

Item	Model	ID x OD x L	Ship	Net	Item	Model	ID x OD x L	Ship	Net
305910	ALBACORE	3/4"x1-1/4"x3"	1 lbs	\$52.99	305923	COD	1-1/4"x2"x5"	2 lbs	\$72.99
305911	BLENNY	7/8"x1-1/4"x3-1/2"	1 lbs	54.99	305924	DEVILFISH	1-3/8"x1-7/8"x5-1/2"	2 lbs	82.99
305912	BARRACUDA	7/8"x1-3/8"x3-1/2"	1 lbs	54.99	305925	DOGFISH	1-3/8"x2"x5-1/2"	2 lbs	89.99
305913	BASS	7/8"x1-1/2"x3-1/2"	1 lbs	57.99	305926	DOLPHIN	1-3/8"x2-1/8"x5-1/2"	2 lbs	92.99
305914	BLACKFISH	1"x1-1/4"x4"	1 lbs	54.99	305927	FLATFISH	1-1/2"x2"x6"	2 lbs	99.99
305915	BLOATER	1"x1-3/8"x4"	1 lbs	54.99	305928	FLOUNDER	1-1/2"x2-3/8"x6"	2 lbs	104.99
305916	BONITO	1"x1-1/2"x4"	1 lbs	56.99	305929	GROUPE	1-3/4"x2-3/8"x7"	3 lbs	119.99
305917	BROADBILL	1"x1-5/8"x4"	1 lbs	56.99	305930	HADDO	1-3/4"x2-5/8"x7"	3 lbs	123.99
305918	CAMA	1-1/8"x1-1/2"x4-1/2"	1 lbs	67.99	305931	HERRING	2"x2-5/8"x8"	3 lbs	137.99
305919	CARP	1-1/8"x1-5/8"x4-1/2"	1 lbs	67.99	305932	KINGFISH	2"x3"x8"	4 lbs	139.99
305920	CATFISH	1-1/8"x1-3/4"x4-1/2"	1 lbs	69.99	305933	MARLIN	2-1/4"x2-15/16"x9"	4 lbs	184.99
305921	CHOGSET	1-1/4"x1-1/2"x5"	1 lbs	67.99	305934	MINNOW	2-1/4"x3-1/8"x9"	5 lbs	189.99
305922	CHUB	1-1/4"x1-3/4"x5"	2 lbs	69.99					



### Western Pacific Trading Syntef Packing Shaft Lube

- PTFE-based additive prolongs the life of shaft packing
- Allows water to be sealed out more completely
- Reduces heat and friction
- Works better and lasts longer than competitors' products
- 1-1/2 oz. plastic squeeze tube

Item	Ship	Net
305079	1 lbs	\$8.99



Item	Model	Blades	O.D."	Width"	Shaft" / Type	Ship	Net
301306	1210-0001-P	12	2-1/4	1-1/4	5/8 / 12pt spline	1 lbs	\$34.99
506414	1210-0003-P	12	2-1/4	1-1/4	5/8 / spline drive	1 lbs	35.99
301280	18948-0001-P	12	2-9/16	1-5/8	5/8 / keyway	1 lbs	44.99
506407	17935-0001-P	12	3-3/4	2-1/2	1 / spline drive	2 lbs	64.99
506406	17936-0001-P	12	3-3/4	3-1/2	1 / spline drive	2 lbs	102.99
500938	18673-0001-P	10	2	7/8	1/2 / pin type	1 lbs	43.99
506360	18653-0001-P	10	2	7/8	5/32 / slotted shaft pin	1 lbs	44.99
301991	17937-0001-P	10	2-9/16	2	5/8 / 12pt spline	1 lbs	38.99

Item	Model	Blades	O.D."	Width"	Shaft" / Type	Ship	Net
506408	920-0001-P	8	2-9/16	2	5/8 / spline drive	1 lbs	\$37.99
506410	920-0003-P	8	2-9/16	2	5/8 / spline drive	1 lbs	37.99
506411	14750-0003-P	8	1-1/4	15/32	5/16 / single flat	1 lbs	35.99
501061	5616-0001-P	6	2	7/8	1/2 / ding drive	1 lbs	89.99
506412	22405-0001-P	6	1-9/16	3/4	15/32 / slotted shaft pin	1 lbs	25.99
506415	6303-0001-P	6	2	7/8	5/16 / single flat	1 lbs	29.99
502399	6303-0003-P	6	2	7/8	5/16 / single flat	1 lbs	28.99
503005	90061-0006	6	2	7/8	5/16 / single flat	1 lbs	41.99



**GLOBE RUN-DRY IMPELLERS**

Made of elastomer compounds and developed for optimum performance. Self-lubricating for run dry protection. Elastomers give the combined characteristics and multiple properties of rubber, nitrile, viton and neoprene. Great resistance to sand and dirt abrasion. Color: Blue.

**RUN DRY FOR 15 MINUTES!**

Self-lubricating for run dry protection. Elastomers give the combined characteristics and multiple properties of rubber, nitrile, viton and neoprene. Great resistance to sand and dirt abrasion. Color: Blue.

**Globe Run-Dry Impellers & DriveSaver®**

Item	Model	Blades	O.D."	Width"	Shaft" / Type	Ship	Net
301960	630	12	3-1/4	2-7/8	.79 / keyway	1 lbs	\$62.99
301344	625	12	2-9/16	1-5/8	5/8 / keyway	1 lbs	38.99
301963	1130	12	2-1/4	25/32	1/2 / keyway	1 lbs	44.99
301305	75	12	2-1/4	1-1/4	5/8 / spline	1 lbs	39.99
301324	125	9	3-3/4	2-1/2	1 / spline	1 lbs	50.99

Item	Model	Blades	O.D."	Width"	Shaft" / Type	Ship	Net
301008	2001	8	2-9/16	2	3/4 / single flat	1 lbs	\$61.99
301307	100	8	2-9/16	2	5/8 / spline	1 lbs	47.99
301357	6541	6	2	7/8	1/2 / pin drive	1 lbs	51.99
303786	815	6	2	7/8	1/2 / single flat	1 lbs	23.99
301965	418	6	2	7/8	1/2 / keyway	1 lbs	47.99

**THE DRIVESAVER – TOTAL PROTECTION FOR YOUR DRIVE TRAIN**

Absorbs vibration, reducing noise. Provides a flexible, non-metallic barrier between your transmission and shaft. Effectively absorbs thrust and torque from the propeller shaft as well as excessive shock from changing gears and high speed planing. It also helps control damage and misalignment from the torsional engine movement. It keeps on working under normal conditions, for the life of the drive train with no lubrication or maintenance. Provides an impervious barrier that blocks electrical currents from the water. Installs simply and quickly without cutting or machining the shaft.

See [www.gcsmarine.com](http://www.gcsmarine.com) to find the corresponding Globe replacement impeller number.



Item	Model	Flange Dia."	No. of Bolts	Bolt Circle"	Pilot Dia."	Coupling Dia."	Torque (ft./lb.)	Ship	Net
301241	404	4	4	3-1/4	2	5	550	3 lbs	\$342.99
301247	404A	4	4	3-1/4	2-1/2	5	550	3 lbs	309.99
301249	424Y	3.94	4	3.07	1.97	4-1/4	550	2 lbs	324.99
301251	4756	4-3/4	6	3-7/8	2-1/2	5-3/8	675	4 lbs	442.99
301252	504	5	4	4-1/4	2-1/2	6	675	4 lbs	329.99

Item	Model	Flange Dia."	No. of Bolts	Bolt Circle"	Pilot Dia."	Coupling Dia."	Torque (ft./lb.)	Ship	Net
301253	5756	5-3/4	6	4-3/4	3	6-13/16	1800	5 lbs	\$399.99
303784	5756PR	5-3/4	6	4-3/4	3	6-13/16	3000	5 lbs	494.99
303780	5756A	5-3/4	6	4-3/4	3	6-3/8	1800	5 lbs	465.99
301255	7256	7-1/4	6	6	3-3/4	8-3/8	3200	8 lbs	479.99
303781	908	9	8	7-1/2	6	11	3000	14 lbs	649.99
301254	5756B	DriveSaver bushing kit						1 lbs	79.99
301256	7256B	DriveSaver bushing kit						1 lbs	79.99

**SHERWOOD Engine Cooling Pumps**



- (A) Applications:** replaces Crusader pump 97179 **Inlet:** 1" **NPT**  
**Outlet:** 1" **NPT** **Engines:** Crusader 220, 270, 300 and 350  
Item 305798 **E35** Ship 8 lbs **Net \$489.99**
- (B) Applications:** replaces Chrysler Marine pump 4142878  
**Inlet:** 1-1/4" **Outlet:** 1-1/4" **Engine size:** 318 and 360  
Item 305800 **G7B** Ship 7 lbs **Net \$389.99**
- (C) Applications:** replaces Sherwood P101 series pumps  
**Inlet:** 1-1/4" **Outlet:** 1-1/4"  
Item 305802 **P1014** Ship 6 lbs **Net \$479.99**
- (D) Applications:** replaces Sherwood P102, P103, P104, P105 pumps  
**Inlet:** 1-1/4" **Outlet:** 1-1/4"  
Item 305803 **P105** Ship 6 lbs **Net \$254.99**
- (E) Applications:** replaces Sherwood P1730 and 1731 pumps **Inlet:** none **Outlet:** none  
Item 305804 **P1730C** Ship 18 lbs **Net \$509.99**
- (F) Applications:** Perkins model 40-108 (NA003335) and 40-107 diesels  
**Inlet:** 3/4" **Outlet:** 3/4"  
Item 305994 **G65** Ship 5 lbs **Net \$519.99**
- (G) Applications:** replaces Sherwood G701, G701-01, G702-01 **Inlet:** 1" **Outlet:** 1"  
Item 305985 **G702** Ship 5 lbs **Net \$267.99**

**Sherwood Neoprene Impeller Kits**

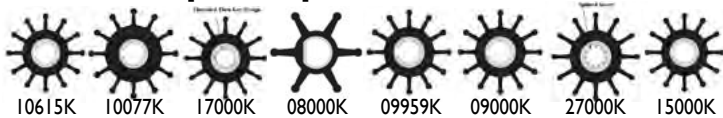

Sherwood impellers are designed to maximize performance and longevity.

**Kit includes:** Impeller, O-ring, gaskets and technical guide **Impeller material:** Neoprene

Item	Model	Width"	Dia"	Blades	Type	Ship	Net
305794	10615K	1-5/8	2-9/16	12	Keyed	1 lbs	\$29.99
305793	10077K	25/32	2-1/4	12	Keyed	1 lbs	31.99
305796	17000K	2-7/8	3-5/16	12	Threaded thru-key	2 lbs	56.99
305790	08000K	3/4	1-9/16	6	Flat	1 lbs	27.99
305792	09959K	1-1/4	2-7/16	12	Keyed	1 lbs	25.99
305791	09000K	7/8	2-7/16	12	Keyed	1 lbs	32.99
305797	27000K	2-7/8	3-5/16	12	Splined	2 lbs	85.99
305795	15000K	2	2-9/16	12	Keyed	1 lbs	49.99

**OBERDORFER ENGINE WATER PUMP**

- Ports: 1/2" - 14 NPT
- Bronze body, high chrome nickel stainless steel shaft
- Will fit universal brand engines with the following model numbers: M-12, M-18, M20, M-25, M-25XP, M30, M40, M50  
Item 302314 **Model N202M-15** Ship 5 lbs **Net \$261.99**



**OBERDORFER ENGINE WATER PUMP**

- Ports: 3/8" - 18 FNPT
- Bronze body, high chrome nickel stainless steel shaft
- Will fit universal brand engines with the following model numbers: M-12, M-18, M-25XP, M-30, M50  
Item 302315 **Model N202M-908** Ship 6 lbs **Net \$389.99**

**OBERDORFER 6 BLADE PUMP IMPELLER**

- Black neoprene for water applications only
- Fits Oberdorfer pumps 201M, 202M, 202M-3, 211M, and 214M
- 1/2" Shaft diameter • 7/8" width
- Drive Type: D hole (Single flat drive)
- Item 500540 **Model 6593** Ship 1 lbs **Net \$43.99**

**JOHNSON PUMP F35B-8007 IMPELLER PUMP**

- Connection: 3/8" NPT
- For engine cooling, bilge pump, washdown, emptying holding tanks
- Material: Bronze body, stainless steel shaft
- Shaft is mounted with two permanently lubricated double ball bearings
- Item 502742 **Model 10-24569-09E** Ship 2 lbs **Net \$203.99**



**JOHNSON PUMP F6B-9 EXTRA FLOW CRANKSHAFT MOUNTED PUMP**

- Flexible impeller pump, Type: High speed / extra flow
- Applications: Chevy 305/350/454 CID/ Ford 302/351 CID engines
- Material: Bronze body, stainless steel shaft
- Item 302151 **Model 10-24930-01** Ship 5 lbs **Net \$167.99**

**JABSCO 2620-SERIES PEDESTAL MOUNT ENGINE COOLING WATER PUMP**

- Flow Rate: 4.4 GPM @ 1500 RPM
- Port Size: 3/8" NPT (Female) internal
- For engine cooling, bilges, washdowns, bait tanks, utility pump
- Self-priming from dry up to 1.5 meters (4.9 feet)
- Item 506455 **Model 2620-1101** Ship 3 lbs **Net \$242.99**

**JABSCO PEDESTAL MOUNT ENGINE COOLING WATER PUMP**

- Flow rate: 8.9 GPM @ 1500 RPM
- Port size: 1/2" NPT (Female) internal
- For engine cooling, bilges, washdowns, bait tanks, utility pump
- Self-priming from dry up to 2.4 meters (7.8 feet)
- Item 506458 **Model 1673-1001** Ship 10 lbs **Net \$299.99**



**Trident Premium Flex Hard Wall Marine Wet Exhaust Hose**

• Wire helix between 2 ply reinforcement, for long runs and tight bends • Exceeds new SAE, J2006-R2, ABYC & NMMA P-I exhaust standards and is Lloyd's Registry Certified • Black high temperature EPDM rubber 280°F

Model	Size-ID	Ship/ft	Net/ft	Model	Size-ID	Ship/ft	Net/ft
100-012	1/2"	1 lbs	\$6.99	250-238	2-3/8"	2 lbs	\$16.99
100-058	5/8"	1 lbs	7.99	250-212	2-1/2"	2 lbs	16.99
100-034	3/4"	1 lbs	8.99	250-278	2-7/8"	3 lbs	20.99
100-078	7/8"	1 lbs	8.99	250-300	3"	3 lbs	20.99
100-100	1"	1 lbs	8.99	250-318	3-1/8"	3 lbs	24.99
100-114	1-1/4"	1 lbs	9.99	250-312	3-1/2"	3 lbs	24.99
250-112	1-1/2"	1 lbs	11.99	250-400	4"	4 lbs	27.99
250-158	1-5/8"	2 lbs	13.99	250-412	4-1/2"	4 lbs	34.99
250-134	1-3/4"	2 lbs	13.99	250-500	5"	4 lbs	35.99
250-178	1-7/8"	2 lbs	14.99	250-600	6"	5 lbs	49.99
250-200	2"	2 lbs	15.99	250-800	8"	9 lbs	69.99

Item 302026  
Please Specify Size



**Trident Premium Ply Soft Wall Marine Wet Exhaust Hose**

• 2 ply reinforcement; no wire helix; for short straight runs • Exceeds SAE, J2006-R2, ABYC & NMMA P-I exhaust standards and is Lloyd's Registry Certified • Black high temp EPDM rubber 280°F

Model	Size-ID	Ship/ft	Net/ft	Model	Size-ID	Ship/ft	Net/ft
200-112	1-1/2"	1 lbs	\$12.99	200-300	3"	2 lbs	\$20.99
200-158	1-5/8"	1 lbs	12.99	200-312	3-1/2"	2 lbs	22.99
200-178	1-7/8"	2 lbs	14.99	200-400	4"	3 lbs	25.99
200-200	2"	2 lbs	14.99	200-500	5"	4 lbs	36.99
200-238	2-3/8"	2 lbs	17.99	200-600	6"	4 lbs	43.99
200-212	2-1/2"	2 lbs	18.99	200-800	8"	8 lbs	61.99
200-278	2-7/8"	2 lbs	20.99	200-1000	10"	9 lbs	90.99

Item 503594  
Please Specify Size



**Trident Series 252 Corrugated Marine Wet Exhaust Hose**

• Thick tube and cover with wire helix between 2 ply reinforcement • Exceeds SAE, J2006-R2, ABYC & NMMA P-I exhaust standards and is Lloyd's Registry Certified • Black high temp EPDM rubber 280°F

Model	Size-ID	Ship/ft	Net/ft	Model	Size-ID	Ship/ft	Net/ft
252-112	1-1/2"	1 lbs	\$14.99	252-300	3"	3 lbs	\$26.99
252-200	2"	2 lbs	17.99	252-400	4"	4 lbs	33.99
252-212	2-1/2"	2 lbs	20.99				

Item 303367  
Please Specify Size

High Temperature Silicone Exhaust Hose Available by Special Order



**Trident Wet Exhaust Rubber Elbows**

- Molded Black high temperature (250°F) EPDM rubber
- Double clamping recommended at each connection
- (4) properly sized stainless steel T-bolt clamps included

Item 302022 • Please Specify Size

Item 302023 • Please Specify Size

**90° ELBOWS**

Model	Size I.D.	Ship	Net
TRL-290SS	2"	2 lbs	\$47.99
TRL-2590SS	2-1/2"	2 lbs	50.99
TRL-390SS	3"	2 lbs	50.99
TRL-3590SS	3-1/2"	2 lbs	58.99
TRL-490SS	4"	3 lbs	58.99
TRL-590SS	5"	4 lbs	67.99
TRL-690SS	6"	5 lbs	77.98
TRL-890SS	8"	10 lbs	166.99

**45° ELBOWS**

Model	Size I.D.	Ship	Net
TRL-345SS	3"	2 lbs	\$48.99
TRL-3545SS	3-1/2"	2 lbs	58.99
TRL-445SS	4"	2 lbs	59.99
TRL-545SS	5"	3 lbs	67.99
TRL-645SS	6"	4 lbs	67.99
TRL-845SS	8"	7 lbs	176.99
TRL-1045SS	10"	9 lbs	189.99



**Trident Wet Exhaust Rubber Hump Hose**

- Molded Black high temperature (250°F) EPDM rubber
  - Double clamping recommended at each connection
  - Packaged with (4) properly sized stainless steel T-bolt clamps
- Item 302024 Please Specify Size 3" - 8" Net \$51.98 - 139.99

Item	Model	Size I.D.	Ship	Net
302445	THHR-43SS	4" to 3"	2 lbs	\$53.99

**TRIDENT 720 & 720-L-SERIES T-BOLT EXHAUST HOSE CLAMPS**

Band and housing: 316 stainless steel, Band width: 3/4"

Item 503488 Please specify clamp range				All Ship 1 lbs			
Model	Clamp Range	Hose ID	Net	Model	Clamp Range	Hose ID	Net
720-1000	1.28"-1.59"	1"	\$9.99	720-2000	2.28"-2.59"	1 7/8"-2"	\$9.99
720-1140	1.53"-1.84"	1-1/8"-1-1/4"	9.99	720-2140	2.53"-2.84"	2-1/8"-2-1/4"	9.99
720-1120	1.78"-2.09"	1-3/8"-1-1/2"	9.99	720-2120	2.78"-3.09"	2-3/8"-2-1/2"	9.99
720-1340	2.03"-2.34"	1-5/8"-1-3/4"	9.99	720-2340	3.03"-3.34"	2-5/8"-2-3/4"	9.99

Item 503489			
Model	Clamp Range	Hose ID	Net
720-3000L	3.37"-3.94"	2-7/8"-3-1/4"	\$9.99
720-3120L	3.87"-4.44"	3-1/2"	9.99
720-4000L	4.37"-4.94"	4"	9.99
720-4120L	4.87"-5.44"	4-1/2"	9.99

**Fiberglass Wet Exhaust Tube Connectors** All ship 1 lbs.

Used to connect exhaust hose to elbows, bellows, hump hose, etc. Heat resistant to 250°.

Item 302025 Please Specify Size 2" - 5" Net \$13.99 - 26.99

Visit [www.defender.com](http://www.defender.com) for details.



**Groco BVS Series-Ball Valve/Strainer Combo**

- One component to install and one bilge location to crawl into for maintenance
- Square hole in handle accepts standard ratchet
- Space saving design with strainer and integral seacock
- Full flow ball valve features stainless steel ball and stem
- #304 Stainless steel filter basket

Item	Model	Pipe Size	Ship	Net	Model	Pipe Size	Ship	Net
503588	BVS-750	3/4"	8 lbs	\$370.99	BVS-1250	1-1/4"	14 lbs	\$565.99
Please Specify Size	BVS-1000	1"	12 lbs	469.99	BVS-1500	1-1/2"	22 lbs	709.99

Please Specify Size



**Raritan Raw Water Strainer**

- Helps protect engine cooling systems, generators, air conditioners and marine toilets
- Nylon strainer basket removes without tools
- Inlet and outlet are 1-1/2" female pipe thread

Item	Model	Description	Ship	Net
301527	RWS	Raw water strainer	3 lbs	\$129.99
301530	RWSSB	Spare basket	1 lbs	28.99



**Groco Raw Water Strainer - STAINLESS STEEL BASKET**

- One-piece molded sight glass eliminates the need for tie rods and gaskets
- O-rings seal all mating surfaces
- Improved basket, handle and drain plug
- Non-metallic screw-on cap magnifies internal viewing

Item	NPT	Height	Ship	Net	NPT	Height	Ship	Net
503583	1/2"	6.4"	5 lbs	\$133.99	1-1/4"	10.6"	7 lbs	\$197.99
Please Specify Size	3/4"	8.4"	5 lbs	133.99	2"	14"	13 lbs	313.99
	3/4"	6.4"	5 lbs	133.99	3"	19.8"	17 lbs	410.99
	1"	9"	6 lbs	184.99				

Item 503583  
Please Specify Size

Other Sizes Available at [www.Defender.com](http://www.Defender.com)

Item	Description	Ship	Starting At
503546	Replacement filter basket Please specify size	1 lbs	\$34.99



**Groco Raw Water Strainer - POLY BASKET**

Filters raw water, keeping sand, silt and other foreign matter out of pumps, engine blocks and oil coolers while giving visual check on water flow. Bronze. Polyethylene strainer basket, neoprene gaskets and sight glass of lucite.

Item	Height	NPT	Ship	Net	Height	NPT	Ship	Net
503584	6.4"	1/2"	5 lbs	\$129.99	9"	1"	6 lbs	\$190.99
Please Specify Size	8.4"	3/4"	5 lbs	133.99	10.6"	1-1/4"	7 lbs	202.99
	6.4"	3/4"	5 lbs	133.99				

Please Specify Size

Other Sizes Available at [www.Defender.com](http://www.Defender.com)

Item	Description	Ship	Starting At
503545	Replacement filter basket Please specify size	1 lbs	\$31.99



**SHURFLO Raw Water Strainers**

These strainers are built to keep your bait tank, livewell, washdown pump or heat exchanger protected from harmful debris. They feature a clear twist off bowl and removable stainless steel screen.

Item	Model	Description	Ship	Net
503595	253-120-01	1/2" strainer, 50 mesh screen	1 lbs	\$34.99
	253-220-01	3/4" strainer, 50 mesh screen	1 lbs	37.99
	253-320-01	1" strainer, 50 mesh screen	1 lbs	58.99
	253-400-01	1-1/4" strainer, 20 mesh screen	2 lbs	63.99

Item	Description	Ship	Starting At
503597	Strainer screen kit Please specify port size	1 lbs	15.99



**Vetus FTR330 Series Cooling Water Strainer**

- Clear inspection cover
- HD Polyethylene filter element
- Dimensions: 162 mm H x 148 mm W

Item	Model	Inlet/Outlet Size (Specify Size)	Ship	Net
502938	FTR330	1/2", 5/8", 3/4", 1", 1-1/4", 1-1/2"	2 lbs	\$109.99
503400	FTR330I	Strainer lid with O-ring	1 lbs	27.99



**Vetus FTR470 Series Cooling Water Strainer**

- Includes transparent cover for easy inspection of filter content
- Mount: Vertical bulkhead
- Strainer rotates 360° to align the hoses
- Polyethylene filter element
- Dimensions: 176 mm H x 150 mm W

Item	Model	Inlet/Outlet Size (Specify Size)	Ship	Net
503483	FTR470	1/2", 5/8", 3/4", 1", 1-1/4", 1-1/2"	2 lbs	\$114.99



**Vetus FTR140 Series Cooling Water Strainer**

- Clear inspection cover
- Due to the large active surface, the filter seldom needs to be cleaned
- Polyethylene filter element
- Dimensions: 111 mm H x 107 mm W

Item	Model	Inlet/Outlet Size (Specify Size)	Ship	Net
502937	FTR140	1/2", 5/8", 3/4"	1 lbs	\$85.99
502939	FTR140I	Strainer lid with O-ring	2 lbs	27.99



**Forespar Marelon T-150 Raw Water Strainer**

- Ports: 1-1/2" Female NPSM (parallel thread)
- Bracket allows strainer to be easily positioned as needed
- Attach a straight or 90° hose barb tailpipe as needed (sold separately)

Item	Model	Description	Ship	Net
501219	906166	Stainless steel screen	2 lbs	\$124.99



**Forespar Marelon MF 810 Water Strainer**

- New universal mounting bracket
- Clear polycarbonate lid for ready inspection
- The stainless steel strainer basket can be easily removed for cleaning

Item	Model	Description	Ship	Net
501216	906066	40 GPM with 1-1/2" ports	3 lbs	\$148.99





## Centek Muffler Systems

Vernalift™



Vernatone™



Gen-Sep™



Vernatone and Vernalift fiberglass exhaust components are made from the highest quality, heat resistant resin. Use Centek wet marine exhaust system fittings like exhaust Y-couplings, exhaust elbows, surge chambers and 180° returns for a premium, long lasting exhaust system.

Centek products are the only products in the world that are Lloyd's Register Type Approved, ISO certified and meet or exceed the ABYC P-1 standards. Visit [www.defender.com](http://www.defender.com) to view our full offering of Centek products.

### VERNATONE ROUND WET EXHAUST MUFFLER

The original FRP water-cooled marine muffler.

• Use: All Inboards • Fuel type: Gas/Diesel • Waterline: Above  
Item **301985** Available in sizes from 3" Inlet/Outlet **Starting at \$179.99**

### VERNATONE MINIMAX ROUND WET EXHAUST MUFFLER

• Use: V-Drives and small spaces • Fuel type: Gas/Diesel • Waterline: Above  
Item **301954** Available in sizes from 3" Inlet/Outlet **Starting at \$169.99**

### VERNALIFT TOP IN-TOP OUT WET EXHAUST MUFFLER

• Use: Inboards, sailboats and generators • Fuel type: Gas/Diesel • Waterline: Above or below  
Item **301899** Available in sizes from 1.5" Inlet/Outlet **Starting at \$164.99**

### VERNALIFT SIDE IN-TOP OUT WET EXHAUST MUFFLER

• Use: Inboards, sailboats and generators • Fuel type: Gas/Diesel • Waterline: Above or below  
Item **301900** Available in sizes from 1.5" Inlet/Outlet **Starting at \$169.99**

### THE GEN-SEP EXHAUST GAS / WATER SEPARATOR

Used in conjunction with a Vernalift style muffler on generator sets. The water drain from the Gen-Sep™ can be located below the waterline to eliminate irritating water splash during overnight moorings.

Item **301987** Available in sizes from 1.5" Inlet/Outlet **Starting at \$299.99**

## WE CAN SPECIAL ORDER CENTEK MUFFLERS & SEPARATORS IN MANY SIZES & VARIATIONS

### FIBERGLASS HI-TEMP EXHAUST FITTINGS

Item	Description
302031	Reducer coupling
302032	45° Elbow
302033	90° Return
302034	180° Return
302037	5' Exhaust Tubing**
302036	10' Exhaust Tubing

Sizes vary in length, width & height\*  
**STARTING AT \$31.99**  
\*Visit [defender.com](http://defender.com) for sizes and prices

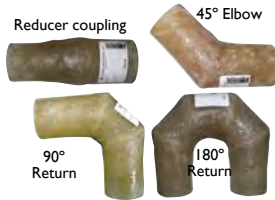

### THRU-HULL EXHAUST FITTINGS

Please Specify Color: Black or White fitting (The flap is Black)

Item	Size	Cut-Out Dia.	Flange Dia.	Depth OA	Depth from Flange	Ship	Net ea.
301747	2"	2"	3.50"	4.50"	2.75"	1 lbs	\$58.99
	3"	3"	4.88"	5.5"	3.00"	1 lbs	74.99
	4"	4"	6.00"	7.75"	4.50"	2 lbs	104.99
	5"	5"	7.50"	9.06"	5.63"	2 lbs	128.99



### FLAPPER REPAIR KITS All ship 1 lbs

Item	Size	Net	Size	Net	Size	Net	Size	Net
301881	2"	\$7.99	3"	\$8.99	4"	\$14.99	5"	\$17.99

## Noise Reduction

### Silent Running™ SR1000 Marine Coating

• High performance, viscoelastic coating dampens vibration and reduces unwanted noise  
• Excellent adhesion to all surfaces, including metal, fiberglass, wood and most plastics

Item	Model	Size	Ship	Net
303677	SR1000Q	Quart	4 lbs	\$37.99
303678	SR1000G	Gallon	13 lbs	101.99

• Easily applied using a brush, roller or spray  
• Use in engine rooms, on gen sets, bow thrusters and more

Item	Model	Size	Ship	Net
300076	SR1000SK	Gal. Spray Kit (requires 70 PSI air source)	16 lbs	\$139.99
303679	SR10005G	5 Gallon	69 lbs	324.99



### Soundown Sound-Stop Foam Panel - with 11lbs foam barrier

• Carefully engineered sound barrier composite of acoustic grade polyester urethane foam  
• High-density mass loaded vinyl barrier and a protective facing of 1 mil heat reflective aluminized film  
• Vinyl foam will reduce noise level and provide thermal insulation when applied to bulkhead walls or engine compartments  
• Laminated to form a durable surface unaffected by dirt, moisture, lubricants and fuels

Item	Model	Description	Sheet Size	Ship	Net
301872	IVF1005MN	1/2" thickness	32" x 54"	13 lbs	\$69.99
	IVF1010MN	1" thickness	32" x 54"	14 lbs	82.99
	IVF1012MN	1-1/4" thickness	32" x 54"	15 lbs	94.99
	IVF1015MN	1-1/2" thickness	32" x 54"	15 lbs	99.99
	IVF1020MN	2" thickness	32" x 54"	16 lbs	109.99

### Soundown Mylar Seam/Installation Tape

• Designed for taping seams and edges of noise reduction panels  
• Material: Polyester foil  
• Color: Silver

Item	Model	Description	Ship	Net
301871	HTA20SC	2" Wide, 125 ft.	1 lbs	\$52.99
	HTA30SC	3" Wide, 125 ft.	2 lbs	59.99



## Exhaust Systems

### VETUS NLP WATERLOCK MUFFLER

The Vetus NLP waterlock muffler's dual stage construction provides superior silencing of exhaust noise with minimal back pressure. The rotating top section and connections make installation easy, even in confined spaces.

- Top chamber and inlet/outlet connections rotate 360°
- Drain plug makes winterizing easy
- Includes nylon mounting straps to secure muffler to the boat
- ID sizes ranging from 1-9/16" to 3-1/2". **Please specify ID when ordering.**

Item	Capacity	ID	W x H x D	Ship	Net
305419	1.2 Gal.	1-9/16", 1-3/4", 2"	15-3/16" x 10-25/64" x 6-1/2"	5 lbs	\$199.99
	2.6 Gal.	2", 2-3/8", 3", 3-1/2"	20-1/4" x 14-1/4" x 8-1/4"	8 lbs	324.99



### NLPG GOOSENECK MUFFLER

The NLPG combines the functions of a muffler and a gooseneck, preventing water from backfilling the exhaust, while reducing exhaust noise.

- ID sizes ranging from 1-9/16" to 3-9/16".
- Please specify ID when ordering.**

Item	Gallon Capacity	ID	H x D	Ship	Net
305421	0.8	1-9/16", 1-3/4", 2"	16-11/32" x 4-1/3"	7 lbs	\$157.99
	2.64	2-3/8", 3", 3-9/16"	23-6/7" H x 6-2/7"	7 lbs	226.99



### VETUS NLPH WATERLOCK MUFFLER

- For horizontal mounting
- Two components and inlet/outlet connections rotate 360°
- Drain plugs make winterizing easy
- Great sound deadening capabilities
- Collects cooling water present in the system when the engine is stopped

Item	H x D	Capacity	Ship	Net
305423	25-2/3" x 4-1/3"	0.8 Gal.	5 lbs	\$157.99



### VETUS AIR VENT ANTI-SYPHON DEVICE WITH VALVE

• For wet exhaust systems • Material: Synthetic • Air bleed connection: Fixed

Item **305428** 1/2", 3/4", 1", and 1-1/4" Hose ID 13' Ship 2 lbs Net \$68.99

• For wet exhaust systems • Material: Synthetic • Air bleed connection: Rotating

Item **305427** 1/2", 3/4", 1", and 1-1/4" Hose ID 13' Ship 2 lbs Net \$66.99

• For wet exhaust systems • Material: Synthetic • Air bleed connection: Rotating

Item **305425** 1/2", 3/4", 1", and 1-1/4" Ship 1 lbs Net \$66.99

• For wet exhaust systems • Material: Synthetic • Air bleed connection: Fixed

Item **305426** 1/2", 3/4", 1", and 1-1/4" Ship 1 lbs Net \$68.99



### VETUS TRANSOM EXHAUST CONNECTION WITH CHECK VALVE

• AISI 316 stainless steel • Connects directly to exhaust hose

Item	Hose I.D./Dia.	Ship	Net	Item	Hose I.D./Dia.	Ship	Net
305859	1-9/16"/2-29/32"	1 lbs	\$99.99	305859	3-1/2"/4-7/8"	2 lbs	\$189.99
	1-3/4"/3-1/8"	1 lbs	112.99		4"/5-1/2"	3 lbs	196.99
	2"/3-5/16"	1 lbs	112.99		5"/6-5/8"	5 lbs	334.99
	2-3/8"/3-11/16"	1 lbs	119.99		6"/7-5/8"	6 lbs	449.99
	3"/4-5/16"	1 lbs	159.99				



## Shaft Line Cutter - For Power and Sail

### SHAFT SHARK

The SHAFT SHARK is a serrated-edge circular blade machined from high quality (316L) type stainless steel. It is easy to install; no drilling, tapping or dismantling required. It is available as a split 2x piece unit for quick and simple installation, no need to remove propeller. There is zero maintenance since there are no moving parts (cutters/bearings/zincs/stops) to maintain. Easy to sharpen if necessary. Attach to your shaft just forward of your propeller, it rotates with the shaft, cutting away any rope, weed or debris that might try to entangle your shaft and propeller while you are underway.

Item	Dia./Model	Description	Ship	Net
614768	3" Split unit only/ #SS300	Please specify shaft diameter: 1.00", 1.125" and 1.25", 25mm, 30mm	1 lbs	\$399.99
614769	4" Split unit only/ #SS400	Please specify shaft diameter: 1.25", 1.375", 1.5", 1.75", 35mm, 38mm	2 lbs	424.99
614770	5" Split unit only/ #SS500	Please specify shaft diameter: 1.75", 2", 2.25", 2.50" (metric available by special order)	2 lbs	628.99
614995	6" Split unit only/ #SS600	Please specify shaft diameter: 2", 2.25", 2.5", 2.75", 3"	2 lbs	772.99

NOTE: LARGER SIZES AVAILABLE AT DEFENDER.COM

## Gori® Folding Propellers

CALL OR EMAIL FOR OUR SELECTION OF GORI® PROPELLERS

All Gori Propellers are Drop Shipped directly from the manufacturer.



FOR OUR SELECTION OF AUTOPROP PROPELLERS VISIT WWW.DEFENDER.COM OR CALL 800-628-8225.

### Ongaro Control Handle Set - Pair

- 316 polished cast stainless steel
- Arms fit Morse® Twin SR and Teleflex CH 5600 controls
- Top weight has been reduced to stay in position during rough seas
- Fit Morse MY-3, MV-2, twin and single controls with 3/8"-24 threads
- Includes one throttle knob that is color coded for sight and grooved for feel and one shift knob that is solid
- Meets ABYC specifications
- All ship 2 lbs

Item	Model	Color	Knob Size	Net
302223	50050	Red throttle knob	1-1/2"	\$124.99
	50055	Gold throttle knob	1-1/2"	124.99

### ONGARO ENGINE CONTROL ARM - REPLACEMENT

- Fits popular Morse Twin SR and SeaStar Solutions CH5600 controls

Item	Model	Color	Size	Knob	Net
302290	50020	Red	1-1/2"	Throttle	\$22.99
	50025	Gold	1-1/2"	Throttle	22.99
	50030*	Silver	1-1/2"	Shift	22.99

1-7/8" throttle and shift control knobs fit Hynautic® D-Dec/Sturdy controls.

Item	Model	Color	Size	Knob	Net
302290	50044	Red	1-7/8"	Throttle	\$24.99
	50048	Gold	1-7/8"	Throttle	24.99
	50040*	Silver	1-7/8"	Shift	24.99

\*These models do not have grooves.

### Replacement Control Knob

- Fits Teleflex controls
- Threaded inserts: Brass
- All ship 1 lbs

Item	Model	Color	Size	Knob	Net
304588	4009819	Black	1-5/8"	Throttle	\$17.99
304589	4009912	Red	1-5/8"	Throttle	17.99

## Vetus Engine Controls

This mechanical remote control is designed for side mounting. The push-pull cables can be installed horizontally or vertically. • Material: AISI stainless steel (handle and housing) • Dimensions: 5-25/32" L x 5" W x 3" H. Handle length from center: 7-7/8". • Mechanism Depth: 9-19/32" from center • Knob Color: Red

Item	Model	SISCO	Ship	Net
304953			5 lbs	\$309.99

## SeaStar Solutions Engine Controls



### SLT Engine Control

- Unique slot feature prevents throttle creep
- Each lever has (2) cable arms (one with slot, one without)
- Stainless steel cover and levers
- Top mount control

Item	Model	Description	Ship	Net
300581	CH5600	Twin	9 lbs	\$354.99



### Single and Twin S Controls

Highly polished stainless steel covers. They feature: chrome-plated levers, stainless steel hanger plate, adjustable brakes and stops. Use with I/Os or inboards. They provide operation of throttle or clutch on a single engine; Twin S controls two throttles or two clutches on a twin engine application and easily adapts to multi-stations.

Item	Model	Description	Ship	Net
301414	CH5210P	Single S	5 lbs	\$203.99
301405	CH5200P	Twin S	7 lbs	244.99



### MT-3 Top Mounted Control

Dual function, single-lever control. Start and warm-up are done by pulling out the hand levers in the neutral position. This disengages the clutch and allows throttle to be advanced in neutral. Returning to neutral detent re-engages clutch. Ideal for Inboards, I/Os and multiple station boats on single and twin engine inboards, outboard and I/O's.

Item	Model	Description	Ship	Net
301418	CH5310P	MT-3 Single	7 lbs	\$299.99
301421	CH5300P	MT-3 Twin	11 lbs	492.99



### SR Twin Control

- Top mount with (2) handles, throttle and shift in each handle
- For use with 33C and 4300 type control cables
- Stainless Steel cover and levers; Knobs: Red and Black

Item	Model	Description	Ship	Net
300464	CH5400P	MT-3 Twin	8 lbs	Net \$263.99



### Sailboat Side Mount Control

This control is the first choice of all premium sail boat manufacturers. Suits 3300/33C type cables.

Item	Model	Description	Ship	Net
302208	CH2100P	Sailboat flush / side mount control	5 lbs	\$185.99



### Xtreme Controls

All Xtreme controls provide an almost effortless and comfortable feel for the end user. The robust control is built upon the SeaStar proven design with modern ergonomics, based on hand size variations, and an aesthetically appealing profile that will make any boat look new.

- Lever/handle updated for aesthetics, ergonomics, and improved durability
- Superior feel and function for most outboards, stern drives & inboards
- Dual-function lever controls both throttle and shift of one engine
- Neutral interlock and start-in-gear protection (standard) for side mount controls
- Optional Trim and/or Trim & Tilt available
- Neutral engine warm-up feature (standard)
- Standard lanyard-style cut-off switch for emergency engine shut down for side mount controls
- Friction adjustment feature included
- "Easy-On" cable design accepts virtually every type of OEM and 3300/33C type cable
- Meets/exceeds all applicable standards
- Designed and assembled in the USA
- Other models available by special order

Item	Model	Description	Ship	Net
302205	CHX8051P	with Eng Cut, Trim Only	6 lbs	\$324.99
	CHX8052P	with Eng Cut, Trim /Tilt	6 lbs	419.99
302206	CHX8151P	with Interlock, Trim Only	6 lbs	389.99
	CHX8152P	with Interlock, Trim/Tilt	6 lbs	399.99
302207	CHX8351P	with Eng Cut, Trim Only	6 lbs	324.99
	CHX8352P	with Eng Cut, Trim/Tilt	6 lbs	419.99





**UNIVERSAL XTREME 3300® PREMIUM CABLES - CCX633 SERIES**

For Yamaha®, Honda®, Nissan, Suzuki®, Tohatsu® and other controls and engines with 10-32 threaded connection on both ends.

**CCX633 SERIES**

Item **302021**  
Please Specify Length

Model	Length	Ship	Net	Model	Length	Ship	Net	Model	Length	Ship	Net	Item	Model	Length	Ship	Net
CCX63306	6'	2 lbs	\$34.99	CCX63313	13'	2 lbs	\$39.99	CCX63320	20'	3 lbs	\$47.99	302044	CCX63330	30'	4 lbs	\$65.99
CCX63307	7'	2 lbs	34.99	CCX63314	14'	3 lbs	41.99	CCX63321	21'	3 lbs	52.99		CCX63332	32'	5 lbs	78.99
CCX63308	8'	2 lbs	36.99	CCX63315	15'	3 lbs	41.99	CCX63322	22'	3 lbs	53.99		CCX63334	34'	5 lbs	88.99
CCX63309	9'	2 lbs	37.99	CCX63316	16'	3 lbs	42.99	CCX63324	24'	3 lbs	55.99		CCX63336	36'	5 lbs	98.99
CCX63310	10'	2 lbs	37.99	CCX63317	17'	3 lbs	44.99	CCX63326	26'	4 lbs	59.99		CCX63338	38'	5 lbs	107.99
CCX63311	11'	2 lbs	37.99	CCX63318	18'	3 lbs	45.99	CCX63327	27'	4 lbs	61.99		CCX63340	40'	6 lbs	113.99
CCX63312	12'	2 lbs	39.99	CCX63319	19'	3 lbs	\$46.99	CCX63328	28'	4 lbs	63.99	Please note item number and length.				

**CONNECTION ADAPTER KITS FOR CCX633 SERIES**

Item	Model	Designed For	Ship	Net
300584	CA27319	Mercury outboard (1965-date), Mercury stern drive (all), Force 1993-date, Mariner 40 HP and below 1993-date, Mariner all above 40 HP, Mercury 1965-date, MerCruiser® all stern drives (except 4000 series controls), Mercury Sport Jet 90 and 120 (throttle cable)	1 lbs	\$25.99
300585	CA27320	OMC/Johnson®/Evinrude® applications: /JE 1979-date, OMC 1979-date, OMC Turbo Jet (throttle control cable)	1 lbs	22.99
300583	CA27024	Universal inboard, (2) CA37701P ball joints and (2) 031419 brackets allow the cable to be mounted and secured to any bulkhead or surface	1 lbs	59.99



**BRP/OMC/JOHNSON/EVINRUDE XTREME® PREMIUM CABLES - CCX205**

1979-date BRP/OMC/Johnson/Evinrude/Gale® with BRP/OMC controls.

**CCX205 SERIES**

Item **302020**  
Please Specify Length

Model	Length	Ship	Net	Model	Length	Ship	Net	Model	Length	Ship	Net	Model	Length	Ship	Net
CCX20506	6'	2 lbs	\$35.99	CCX20512	12'	2 lbs	\$42.99	CCX20518	18'	3 lbs	\$46.99	CCX20524	24'	3 lbs	\$57.99
CCX20507	7'	2 lbs	36.99	CCX20513	13'	2 lbs	43.99	CCX20519	19'	3 lbs	50.99	CCX20525	25'	4 lbs	58.99
CCX20508	8'	2 lbs	38.99	CCX20514	14'	2 lbs	43.99	CCX20520	20'	3 lbs	52.99	CCX20526	26'	4 lbs	59.99
CCX20509	9'	2 lbs	38.99	CCX20515	15'	3 lbs	44.99	CCX20521	21'	3 lbs	54.99	CCX20527	27'	4 lbs	60.99
CCX20510	10'	2 lbs	39.99	CCX20516	16'	3 lbs	45.99	CCX20522	22'	3 lbs	56.99	CCX20528	28'	4 lbs	62.99
CCX20511	11'	2 lbs	41.99	CCX20517	17'	3 lbs	46.99	CCX20523	23'	3 lbs	56.99				



**FLEXIBLE PUSH-PULL UTILITY CABLES WITH T-HANDLE**

- Designed for remote control of choke, throttle, shut off, fuel valves, vents and many other applications
- HDPE outer casing for durability and best resistance to UV and chemicals
- Easy to install, easy to operate
- Core moves easily in HDPE liner
- Cables meet or exceed all applicable industry standards
- Solid stainless steel core wire resists corrosion

Item	Model	Length	Ship	Net
304437	CC34305	5'	2 lbs	\$77.99
304438	CC34310	10'	3 lbs	82.99

**FOR REPLACEMENT OF AN EXISTING CONTROL CABLE:** Measure the cable by laying the cable out and measuring from tip to tip. Round up to the next foot. If you can find the embossed part number on the cable jacket, the control cable part number contains its length. Teleflex cables are usually listed as CCYYYXX, where CC = control cable, YYY = the series and XX = length in feet (i.e., CC17916 would be a control cable, series 179 with a length of 16 feet). Replace with a Xtreme CCX17916. The "X" stands for XTREME.

**MERCURISER ADAPTER KIT**

• For 33C or 43C Supreme Cables

Item	Model	Ship	Net
302228	302123	1 lbs	\$22.99

**Performance Metals Anodes**

**PERFORMANCE METALS MERCURISER SACRIFICIAL ANODE KIT** All models include a patented wear indicator.

Item	Model	Material	Designed For	Ship	Net
755447	10108A	Aluminum	MerCruiser Alpha I and Gen I	3 lbs	\$31.99
755448	10205A	Aluminum	MerCruiser Alpha I and Gen I - non power steering	2 lbs	28.99
755449	10059A	Aluminum	MerCruiser Alpha I Gen 2	2 lbs	38.99
755450	10060A	Aluminum	MerCruiser Bravo I	2 lbs	35.99
755451	10061A	Aluminum	MerCruiser Bravo 2 and 3	2 lbs	27.99
755452	10165A	Aluminum	MerCruiser Bravo 3 (2004+)	3 lbs	41.99
755453	10195A	Aluminum	MerCruiser Bravo prop retrofit	2 lbs	48.99
755454	10202A	Aluminum	Mercury Verado outboard	2 lbs	30.99
755455	10274A	Aluminum	Volvo 280	2 lbs	24.99
755456	10275A	Aluminum	Volvo 280 - dual prop	2 lbs	27.99
755457	10276A	Aluminum	Volvo 290	2 lbs	27.99
755458	10277A	Aluminum	Volvo 290 dual prop	2 lbs	27.99
755459	10278A	Aluminum	Volvo SX	3 lbs	39.99
755462	10182A	Aluminum	Yamaha outboard 200-250 HP 4 stroke	2 lbs	28.99
755463	10183A	Aluminum	Yamaha outboard 150-175 HP	2 lbs	28.99
755464	10184A	Aluminum	Yamaha outboard 150 HP counter rotation	2 lbs	28.99



**PERFORMANCE METALS 'RED DOT' SHAFT SACRIFICIAL ANODE**

All models include a patented red dot wear indicator. Material: aluminum

Item	Model	Inside Diameter	Length x OD	Ship	Net
756939	C0750A	3/4"	2-1/8" x 2-1/8"	1 lbs	\$6.99
	C0875A	7/8"	2-1/8" x 2-1/8"	1 lbs	7.99
	C1000A	1"	2-1/8" x 2-1/8"	1 lbs	7.99
	C1125A	1-1/8"	2-1/8" x 2-1/8"	1 lbs	8.99
	C1250A	1-1/4"	2-1/2" x 2-1/4"	1 lbs	9.99
	C1250AA	1-1/4" (XL Version)	2-1/2" x 2-1/2"	1 lbs	12.99
	C1375A	1-3/8"	2-1/2" x 2-1/2"	1 lbs	11.99
	C1500A	1-1/2"	2-1/2" x 2-1/2"	1 lbs	11.99
	C1750A	1-3/4"	2-7/8" x 3-1/4"	1 lbs	17.99
	C2000A	2"	2-7/8" x 3-1/4"	2 lbs	19.99



C1000A

It is important to protect your boat with quality anodes. Martyr anodes are pressure-die cast and manufactured to OEM specifications. In addition, each alloy used in a Martyr anode undergoes rigorous quality testing to ensure consistency.

### STREAMLINED SHAFT ANODES

	Model	Description	Material	Ship	Net
Item 756701 Please Specify Model	CMX01	CMX-1 (3/4")	Z	1 lbs	\$9.99
	CMX02	CMX-2 (7/8")	Z	1 lbs	10.99
	CMX03	CMX-3 (1")	Z	1 lbs	12.99
	CMX04	CMX-4 (1-1/8")	Z	2 lbs	12.99
	CMX05	CMX-5 (1-1/4")	Z	2 lbs	13.99
	CMX05A	CMX-5A (1-1/4" Extra heavy)	Z	2 lbs	19.99
	CMX06	CMX-6 (1-3/8")	Z	2 lbs	15.99
	CMX07	CMX-7 (1-1/2")	Z	2 lbs	16.99
	CMX08	CMX-8 (1-3/4")	Z	3 lbs	20.99
	CMX09	CMX-9 (2")	Z	4 lbs	22.99
Item 756702 Please Specify Model	CMX10	CMX-10 (2-1/4")	Z	7 lbs	37.99
	CMX11	CMX-11 (2-1/2")	Z	7 lbs	39.99
	CMX12	CMX-12 (2-3/4")	Z	7 lbs	61.99
	CMX13	CMX-13 (3")	Z	7 lbs	61.99
	CMX25	CMX-25 (25 mm)	Z	2 lbs	14.99
	CMX30	CMX-30 (30 mm)	Z	2 lbs	15.99
	CMX01AL	CMX-1A (3/4")	A	1 lbs	9.99
	CMX02AL	CMX-2A (7/8")	A	1 lbs	10.99
	CMX03AL	CMX-3A (1")	A	1 lbs	10.99
	CMX04AL	CMX-4A (1-1/8")	A	1 lbs	12.99
CMX05AL	CMX-5AL (1-1/4")	A	1 lbs	12.99	
CMX06AL	CMX-6A (1-3/8")	A	1 lbs	15.99	
CMX07AL	CMX-7A (1-1/2")	A	1 lbs	15.99	
CMX08AL	CMX-8A (1-3/4")	A	1 lbs	24.99	
CMX09AL	CMX-9A (2")	A	2 lbs	24.99	



CMZ24BSZ



CMM25



CMZHC2AZ



CMDIVERA



CMNI Z



CMT20  
CMT21

### PLEASURECRAFT HULL ANODES

	Item	Model	Description	Material	Ship	Net
Item 756701 Please Specify Model	204291	CMMZC406 Z	MZ406 (Lg streamlined bolt-on)	Z	8 lbs	\$45.99
	304055	CMZ24BS Z	CMZ24B (Zn semi-str Bolt-on 14" x 6-1/4" x 1-1/4")	Z	22 lbs	159.99
	204292	CMM25 Z	M-25 (Sm streamlined bolt-on)	Z	4 lbs	21.99
	304056	CMM25 A	M-25 (Sm streamlined bolt-on)	A	2 lbs	28.99
	204293	CMM30 Z	M-30 (Med streamlined bolt-on)	Z	2 lbs	17.99
	204294	CMZHC2A Z	ZHC-2 (Med streamlined bolt-on)	Z	3 lbs	24.99
	204295	CMZHC3A Z	ZHC-3 (Med streamlined bolt-on)	Z	2 lbs	25.99
	204296	CMZHC5A Z	ZHC-5 (Lg streamlined bolt-on)	Z	5 lbs	31.99
	204297	CMDIVERMINI Z	Mini Divers Dream (1/2" x 4" x 6" slotted bolt-on)	Z	3 lbs	19.99
	304057	CMDIVERMINIA	Mini Divers Dream (1/2" x 4" x 6" slotted bolt-on)	A	2 lbs	21.99
Item 756702 Please Specify Model	204298	CMDIVER Z	Divers Dream (Slotted bolt-on plate anode)	Z	8 lbs	48.99
	303742	CMDIVERA	Divers Dream (1/2" x 6" x 12" slotted bolt-on)	A	4 lbs	28.99
	204326	CMDIVER M	Divers Dream (1/2" x 6" x 12" slotted bolt-on)	M	3 lbs	66.99
	304058	CMNI Z	NI (Med streamlined bolt-on)	Z	3 lbs	15.99
	304059	CMPMW Z	"M" Plate (small plate w/wire)	Z	3 lbs	12.99
	204351	CMT20	CMT-20 (Sm teardrop bolt-on anode)	Z	1 lbs	8.99
	204352	CMT21	CMT-21 (Med teardrop bolt-on)	Z	1 lbs	12.99

### RUDDER ANODES

	Model	Description	Material	Ship	Net
Item 756650 Please Specify Model	CMR01	1-7/8" Trim-tab disc anode	Z	1 lbs	\$5.99
	CMR02	2-13/16" Trim-tab disc anode	Z	1 lbs	10.99
	CMR03	3-3/4" Trim-tab disc anode	Z	2 lbs	16.99
	CMR04	5" Trim-tab disc anode	Z	4 lbs	23.99
	CMR05	5-1/8" Trim-tab disc anode	Z	5 lbs	30.99
Item 756700 Please Specify Model	CMR07	6-7/8" Trim-tab disc anode	Z	6 lbs	47.99
	CMR01AL	1-7/8" Trim-tab disc anode	A	1 lbs	4.99
	CMR02AL	2-13/16" Trim-tab disc anode	A	1 lbs	8.99
	CMR03AL	3-3/4" Trim-tab disc anode	A	1 lbs	11.99
	CMR04AL	5" Trim-tab disc anode	A	1 lbs	22.99



CMR01



CMR02



CMR03

### LIMITED CLEARANCE SHAFT ANODES

	Model	Description	Material	Ship	Net
Item 756675 Please Specify Model	CMC01 Z	CMC-1 (3/4")	Z	1 lbs	\$10.99
	CMC02 Z	CMC-2 (7/8")	Z	1 lbs	11.99
	CMC03 Z	CMC-3 (1")	Z	2 lbs	14.99
	CMC04 Z	CMC-4 (1-1/8")	Z	2 lbs	14.99
	CMC05 Z	CMC-5 (1-1/4")	Z	2 lbs	14.99
	CMC06 Z	CMC-6 (1-3/8")	Z	2 lbs	15.99
	CMC07 Z	CMC-7 (1-1/2")	Z	2 lbs	16.99
	CMC08 Z	CMC-8 (1-3/4")	Z	3 lbs	19.99
	CMC09 Z	CMC-9 (2")	Z	3 lbs	19.99



CMC01



CMC02

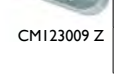

CMC03

### MAX PROP ANODES

Item	Model	Description	O.D.	Mat.	Ship	Net
203717	CMMP63R Z	3/4" - 1-1/8" shaft	2-3/8"	Z	1 lbs	\$15.99
204396	CMMP70R Z	1-1/4" - 1-3/8" shaft	2-5/8"	Z	2 lbs	21.99
304054	CMMP83R Z	1-1/2" - 1-3/4" shaft	3-1/8"	Z	2 lbs	22.99



CMMP63R Z

### GROUPE ANODES

Item	Model	Description	Material	Ship	Net
204317	CMGROUPE RZ	Hanging anode	Z	6 lbs	\$39.99
303746	CMGROUPE RA	Hanging anode	A	3 lbs	37.99
304051	CMGROUPE RM	Hanging anode	M	3 lbs	66.99



CMGROUPE RZ

### PROPELLER NUT ANODE ASSEMBLY

	Item	Model	Description	Material	Ship	Net
Item 756701 Please Specify Model	204303	CMPNBZC11	Assembly B - Complete (5/8" NC 11)	Z	1 lbs	\$28.99
	204304	CMPNCZC10	Assembly C - Complete (3/4"-10 UNC)	Z	2 lbs	33.99
	204305	CMPNDZC09	Assembly D - Complete (7/8"-9 UNC)	Z	3 lbs	39.99
	204299	CMPNZB	B-Replacement anode	Z	1 lbs	17.99
	204300	CMPNZC	C-Replacement anode	Z	2 lbs	19.99
Item 756702 Please Specify Model	204301	CMPNZD	D-Replacement anode	Z	2 lbs	23.99
	204302	CMPNZE	E-Replacement anode	Z	2 lbs	24.99



CMPNBZC11



CMPNCZC10



CMPNDZC09

### BENNETT TRIM TAB ANODES

Item	Model	Description	Material	Ship	Net
304505	CMBNT1AKIT Z	Trim-tab anode kit (2)	Z	1 lbs	\$20.99
306013	CMBNT1AKITA	Trim-tab anode kit (2)	A	1 lbs	17.99



CMBNT1AKITZ

### BOMBARDIER (JOHNSON/EVINRUDE)

Item	Model	Description	Material	Ship	Net
204228	CM123009 Z	CM-123009 Small block	Z	1 lbs	\$8.99
204231	CM393023 Z	CM-393023 Block	Z	1 lbs	14.99
204232	CM398331 Z	CM-398331 Block	Z	1 lbs	16.99
204233	CM5007089Z CM433580 Z	Old OEM # CM433580Z (Power trim and tilt models)	Z	2 lbs	18.99



CM123009 Z

### HONDA ANODE KITS

Item	Model	Description	Material	Ship	Net
756597	CMHBF75115KITA	For Honda outboards 75, 90, 115 HP	A	2 lbs	\$29.99
756598	CMHBF75115KITM	For Honda outboards 75, 90, 115 HP	M	2 lbs	43.99



CMHBF75115KITA

Magnesium (M) for fresh water use only



## MERCURY/MERCUISER ANODE KITS

Item	Model	Description	Mat.	Ship	Net
756907	CMALPHAKITA	Alpha I Gen II Kit	A	3 lbs	\$46.99
756907	CMALPHAKIT Z	Alpha I Gen II Kit	Z	6 lbs	46.99
303744	CMBRAVO1KITA	Bravo I Kit (Aluminum)	A	3 lbs	42.99
204706	CMBRAVO1KIT Z	Bravo I Kit (Zinc)	Z	6 lbs	41.99
303745	CMBRAVO23KITA	Bravo 2 and 3 Kit	A	3 lbs	47.99
204707	CMBRAVO23KIT Z	Bravo 2 and 3 Kit	Z	5 lbs	41.99
756909	CMBRAVO3KITA	Bravo 3 2004+ Kit	A	3 lbs	44.99
756909	CMBRAVO3KIT Z	Bravo 3 2004+ Kit	Z	7 lbs	44.99
204709	CMVERADO4KITA	Verado 4 Cyl Kit	A	2 lbs	38.99
204710	CMVERADO6KITA	Verado 6 Cyl Kit	A	2 lbs	61.99
204821	CM762144KITA	Trim tab flat w/mtg bolt	A	1 lbs	15.99
756880	CMM3060KITA	F30 HP, F40 HP, F60 HP	A	2 lbs	20.99
756880	CMM3060KIT Z	F30 HP, F40 HP, F60 HP	Z	5 lbs	24.99
756880	CMM3060KITM	F30 HP, F40 HP, F60 HP	M	2 lbs	43.99
756881	CMM75115KITA	75 HP, 80 HP, 90 HP, 100 HP, 115 HP	A	2 lbs	20.99
756881	CMM75115KIT Z	75 HP, 80 HP, 90 HP, 100 HP, 115 HP	Z	5 lbs	22.99
756881	CMM75115KITM	75 HP, 80 HP, 90 HP, 100 HP, 115 HP	M	2 lbs	37.99
756908	CMALPHAGENIKITA	Alpha I, Generation I, 1983-90	A	2 lbs	28.99
756908	CMALPHAGENIKITM	Alpha I, Generation I, 1983-90	M	2 lbs	48.99



CMALPHAKITA



CMVERADO6KITA



CMM3060KIT



CMM75115KIT

## SUZUKI OUTBOARD ANODE KITS

Item	Model	Description	Mat.	Ship	Net
756810	CM5Z90140KITA	90 - 140 HP	A	1 lbs	\$20.99
756810	CM5Z90140KITZ	90 - 140 HP	Z	2 lbs	21.99
756810	CM5Z90140KITM	90 - 140 HP	M	1 lbs	26.99



CM5Z90140

## VOLVO ANODE KITS

Item	Model	Description	Mat.	Ship	Net
204700	CM280KITA	280 Kit	A	2 lbs	\$32.99
204356	CM3855411 Z	SX outdrive transom plate	Z	3 lbs	25.99
204702	CMSXKITA	SX drive	A	3 lbs	52.99
204704	CM290DPKITA	290 dual prop kit	A	2 lbs	35.99



CM280KITA

## VOLVO PENTA ANODES

Item	Model	Description	Mat.	Ship	Net
204259	CM832598 Z	Dogbone	Z	3 lbs	\$20.99
204731	CM852835A	Bar	A	1 lbs	16.99
204261	CM852835 Z	Bar	Z	2 lbs	22.99
204733	CM875812 Z	Saildrive ring	Z	2 lbs	17.99
204262	CM875821 Z	Duo-prop ring	Z	2 lbs	20.99



CM875821 Z

## MERCURY PROP NUT ANODES

Item	Model	Description	Mat.	Ship	Net
204712	CM865182C Z	Bravo 3 (2004 to present) prop nut only	Z	2 lbs	\$6.99



Prop Nut

## MERCURY/MERCUISER ANODES

Item	Model	Description	Mat.	Ship	Net
204214	CM31640 Z	Standard skeg - fits Gen II	Z	2 lbs	\$11.99
204714	CM31640A	Standard skeg - fits Gen II	A	1 lbs	8.99
204246	CM43994 Z	Outdrive block	Z	3 lbs	21.99
204247	CM46399 Z	Cutdown skeg	Z	1 lbs	11.99
204248	CM55989 Z	Button	Z	1 lbs	5.99
204716	CM55989A	Button	A	1 lbs	5.99
204217	CM762145 Z	New Generation - Replaces 76214 circular plate	Z	1 lbs	7.99
204718	CM762145A	New Generation - Circular plate, replaces 76214	A	1 lbs	8.99
204719	CM806105 Z	Bearing carrier anode Alpha I	Z	1 lbs	12.99
204218	CM806188 Z	Bearing carrier anode Bravo I & 3	Z	1 lbs	19.99
204249	CM806189 Z	Alpha lift-ram horseshoe Gen II	Z	1 lbs	8.99
204722	CM806189A	Alpha lift-ram horseshoe Gen II	A	1 lbs	5.99
204250	CM806190 Z	Bravo lift-ram horseshoe Gen II	Z	1 lbs	10.99
204723	CM806190A	Bravo lift-ram horseshoe Gen II	A	1 lbs	9.99
204219	CM818298 Z	Outboard bar	Z	2 lbs	16.99
204724	CM818298A	Outboard bar	A	1 lbs	9.99
204251	CM821629CZ	Alpha plate - Gen II	Z	2 lbs	19.99
204725	CM821629CA	Alpha plate - Gen II	A	1 lbs	15.99
204220	CM826134 Z	Wedge - Gen II	Z	1 lbs	9.99
204729	CM826134A	Wedge - Gen II	A	1 lbs	6.99



CM31640Z



CM55989A



CM762145Z



CM806105Z



CM806190Z

## YAMAHA ANODES

Item	Model	Description	Mat.	Ship	Net
204736	CM61A4537100A	Skeg, 225 - 250 HP	A	1 lbs	\$19.99
204222	CM61A4537100 Z	Skeg, 225 - 250 HP	Z	2 lbs	21.99
204737	CM61N4525101A	Trim tab plate, '95-'98 C25	A	1 lbs	15.99
204223	CM61N4525101 Z	Trim tab plate, '95-'98 C25	Z	1 lbs	16.99
204605	CM6884525101 Z	Button	Z	1 lbs	2.99
204224	CM6884537102 Z	Skeg	Z	2 lbs	16.99
204758	CMYHP200300KITA	Anode kit, 200-300 HP	A	2 lbs	30.99
204744	CM6E04525111A	Small block	A	1 lbs	6.99
204236	CM6E04525111 Z	Small block	Z	1 lbs	11.99
204748	CM6G54525101A	Handlebar	A	1 lbs	12.99
204225	CM6G54525101 Z	Handlebar	Z	2 lbs	24.99
204359	CM6H14525102 Z	Bar	Z	2 lbs	18.99
204750	CM6J94537101A	Skeg	A	1 lbs	18.99
204227	CM6K14537100 Z	Counter rotation to CM6E54537101	Z	1 lbs	22.99



CM61N4525101Z



CM6884525101Z



CM6E04525111A

## YAMAHA ANODE KITS

Item	Model	Description	Mat.	Ship	Net
204756	CMY150KITA	150-200 HP kit	A	2 lbs	\$29.99
204757	CMY200250KITA	200-250 HP kit	A	2 lbs	30.99
756599	CMY6090KITA	60-90 HP, 2-stroke	A	1 lbs	19.99
756600	CMY6090KITM	60-90 HP, 2-stroke	M	1 lbs	24.99
756601	CMY4060KITA	40-60 HP, 4-stroke	A	1 lbs	17.99
756602	CMY4060KITM	40-60 HP, 4-stroke	M	1 lbs	24.99



CMY6090KITA

## ENGINE ANODES WITH PLUG

Item	Model	Description	Mat.	Ship	Net
204307	CME00Z	1/8 NPT x 1/4" x 2"	Z	1 lbs	\$4.99
204308	CME0 Z	1/4 NPT x 3/8" x 1-3/4"	Z	1 lbs	5.99
204309	CME1 Z	3/8 NPT x 1/2" x 2"	Z	1 lbs	9.99
204310	CME2 Z	1/2 NPT x 5/8" x 2"	Z	1 lbs	9.99
204311	CME3 Z	3/4 NPT x 3/4" x 2"	Z	1 lbs	11.99
204759	CM272100200300 Z	Yanmar pencil	Z	1 lbs	4.99



Pencil

## YANMAR SAILDRIVE ANODE KIT

Item	Model	Description	Mat.	Ship	Net
755978	CM19644002660KIT Z	SD20, SD30, SD31, SD40 and SD50	Z	2 lbs	\$49.99



ZINCS / ANODES

PHONE 800-628-8225 • FAX 800-654-1616

**Zinc (Z)** • For use in salt water only  
• Meets or exceeds US Military Spec

**Aluminum (A)** • For use in salt and brackish water  
• Lasts longer than zinc due to increased capacity  
• Meets or exceeds US Military Spec

**Magnesium (M)** • For use in fresh water only  
• The only alloy proven to protect your boat in fresh water

## Steering Wheels

### Lewmar/Whitlock 6-Spoke Folding Steering Wheel

A must for cruisers who want to open up deck and cockpit space to improve access while moored. An off-the-shelf version of its innovative custom folding wheel at a price that will appeal to a wide market. Conventional wheels act as a barrier across most cockpits, thereby reducing space and movement. The Lewmar folding wheel has resolved this problem by introducing a concept in space saving.

- Ingenious patented folding mechanism allows varying wheel diameters to effectively close and become less intrusive without the need to remove it
- Unique hinging system allows fast action handgrip release to fold and unfold the wheel
- Two-turn buttress-threaded, split-spoke design is operated by the simple twist of the composite hand grip
- Wheel can be folded when not in use to give better visibility to instruments
- Comes complete with a fitted, handsewn hide cover

Specifications:

- 7/8" rim diameter
- Dual Hub fits 1" Morse taper shaft and 1" parallel shaft
- Single-row six-spoke wheel available in 32", 36", 40" and 42" diameters

Item	Model	Size	Ship	Net
D 608427	89700406	32"	33 lbs	\$797.99
D	89700407	36"	33 lbs	827.99
D	89700408	40"	33 lbs	868.99
D	89700521	42"	33 lbs	1242.99



Visit [www.defender.com](http://www.defender.com) for many more steering wheel styles and sizes or call us at 800-628-8225.

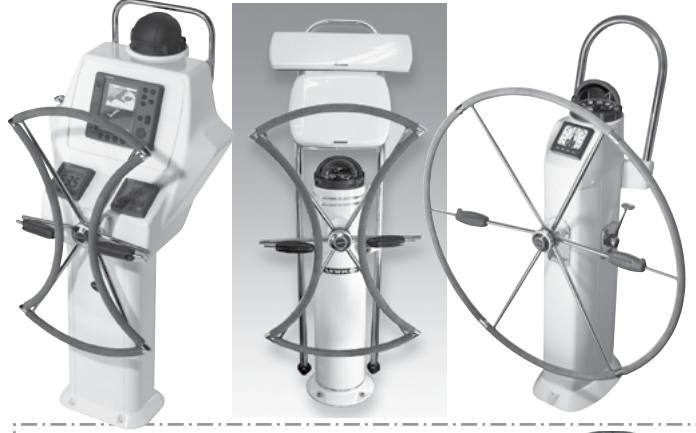

## Steering Wheel & Pedestal Accessories

### EDSON DELUXE LEATHER WHEEL COVERING KITS - 1"

- For wheels with 1" diameter rims (3.11" circumference)
  - Orthopedic grade cowhide
  - Wheel cover stays supple, even when subjected to harsh marine environments
  - Wheel covering kits look great and make any wheel softer and warmer to the touch
- All Ship 2 lbs



Color: Dove Gray, 1" D shaped

Item	Fits Wheels	Net	Item	Fits Wheels	Net
614001-20-1	15" - 20" dia.	\$166.99	614001-40-1	32" - 40" dia.	\$199.99
614001-30-1	22" - 30" dia.	189.99	614001-60-1	42" - 60" dia.	273.99

### EDSON DELUXE LEATHER WHEEL COVERING KITS- 7/8"

- For wheels with 7/8" diameter rims (2.7" circumference)
  - Includes pre-punched orthopedic leather cover, double-side sticky tape, thread, needle and instructions
- All Ship 1 lbs

Color: Dove Gray, 7/8" Oval shaped

Item	Fits Wheels	Net	Item	Fits Wheels	Net
614001-20-78	15" - 20" dia.	\$153.99	614001-40-78	32" - 40" dia.	\$198.99
614001-30-78	22" - 30" dia.	170.99	614001-60-78	42" - 60" dia.	270.99

### EDSON "COMFORTGRIP" LEATHER WHEEL COVERING KIT

- Cushioned feel with contoured finger grips on the inside of the wheel rim

Specify: 7/8" or 1" wheel rim

Color: Dove Gray

Item	Fits Wheels	Prices Range From
614002	From 15" - 60"	\$195.99 to 396.99



### EDSON QUICK RELEASE WHEEL NUT

- Created to make it easier to remove steering wheels
- Large, textured 2-1/2" diameter provides easy grip
- Constructed of highly polished investment cast 316 stainless steel

Item	Model	Description	Ship	Net
613073	826ST-1-14	1", 14 shaft threads	1 lbs	\$72.99
613074	826ST-3/4-10	3/4", 10 shaft threads	1 lbs	76.99



### EDSON WHEEL NUT KITS

- Highly polished stainless steel • Adapters included

Item	Model	Thread	Ship	Net
300024	673ST-KIT	1/2", 5/8", 1" or 12 mm	1 lbs	\$51.99



### LEWMAR QUICK RELEASE WHEEL NUT

- Fitted with a standard winch handle socket for a quick, simple way to unship your wheel
- 316 grade stainless steel - polished to a mirror finish
- To suit Commodore / Mini Maxi / Carbon / Fastnet wheels

Item	Fits Wheels	Ship	Net	Item	Fits Wheels	Ship	Net
614807	Commodore and Folding	1 lbs	\$34.99	614808	Mini Maxi Fastnet and Carbon	1 lbs	\$40.99



### FORESPAR STEERING CONTROL ARM

- Works with tubing clips in diameters of 3/4", 7/8", 1" and 1-1/8" • Allows piloting from the stern seat • Provides greater forward visibility • Permits easy course corrections that an autopilot can't perform • Installs in seconds!

Item	Model	Ship	Net
601799	104018	2 lbs	\$134.99



### EDSON PEDESTAL GUARD KITS

- Guards measure 1-1/8" for easier instrument wiring
- Complete guard includes tube, stainless steel top plate, mounting bolts, feet and drilling template • Offset provides improved visibility of mounted instruments • Top plate diameter: 6-7/8" • 9.5" center to center guard width

Item	Model	Ship	Net
254584	1600-45-58S	12 lbs	\$405.99

58" H x 1-1/8" dia. Straight Guard Kit

D 254585 1610-45-58OS 29 lbs 432.99

58" H x 1-1/8" dia. Stainless Steel Offset Guard Kit

D 254586 1620-45-58A 32 lbs 425.99

58" H x 1-1/8" dia. Stainless Steel Angled Guard Kit

600120 1625ST-45 2 lbs 110.99

Replacement Top Plate (works for 1" and 1-1/4" as well)



### EDSON COMFORTGRIP STRIPS

- For 1" to 1.25" Diameter Railings, Select Length • Material: High Performance Santoprene Construction with 3M Adhesive • Tactile Grips Ergonomically Cushion Fingers Providing a Secure Hold, 3-Pack

Item	Model	Length	Ship	Net
756926	97001	8"	1 lbs	\$22.99
	97002	12"	1 lbs	26.99



### EDSON PEDESTAL CLUTCH AND THROTTLE CONTROL

- Clutch handle is 6" (152 mm) long
- Operates up and down by reaching over the wheel
- Throttle handle is polished stainless steel
- Clearly marked for "Fast" and "Slow" speeds
- Throttle friction adjustment screw is standard
- Clutch travel limiter is standard

Item	Model	Ship	Net
300077	816ST-45	6 lbs	\$400.99



### EDSON PULL/PULL CONDUIT

- 3/4" diameter for 3/16" and 1/4" wire rope
- Available in one foot increments
- Conduit can easily be cut with a hacksaw

Item	Model	Ship	Net
600638	853-250	1 lbs	\$20.99/ft



### EDSON CONDUIT END FITTING FOR 853-250 CONDUIT

- Two fittings are required for each length of conduit
- Molded in white Celcon™
- End fitting thread size of 7/8"-9" to fit Edson's size 250 (3/4" OD) conduit

Item	Model	Ship	Net
600510	854-250	1 lbs	\$34.99 each





## Steering Wheel & Pedestal Accessories

### EDSON ENGINE CONTROL LEVERS

- Highly polished; marked "Fast-Slow" and "Fwd-Rev"
- These handles are for Edson's dual lever engine controls only
- Older (pre-1980) pedestals with 10-32 engine control shaft threads must be retapped to 1/4"-28 in order accept the mounting screws supplied

Item	Model	Description	Ship	Net
613033	963PT-55	Clutch	1 lbs	\$62.99
613034	963SB-55	Throttle	1 lbs	62.99

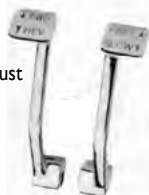

### EDSON PEDESTAL WHEEL BRAKE

- For Pre-2003 Steerers
- Dampen the action of the wheel
- The brake can always be overridden by the helmsman
- Constructed of bronze with long-lasting brake linings
- Supplied with a stainless steel shaft and brake knob

Item	Model	Ship	Net
253164	689ST-456	2 lbs	\$234.99
302105	825ST-1	1 lbs	72.99



### EDSON BRAKE MAINTENANCE KIT

- All you need for relining your boat's wheel brake.
- (2) Bronze brake legs w/brake pads
- Stainless steel washer
- Removal and installation instructions
- Cotter pin
- Nylon bushing

NOTE: For Edson's side-mount wheel brakes only, NOT for thru-shaft wheel brakes.

Item	Model	Ship	Net
301068	316-689	1 lbs	\$73.99



### EDSON GUARD FEET KIT

- Includes (2) stainless steel guard feet and mounting bolts. Gasket and bushing allow for mounting 1", 1-1/8" or 1-1/4" guard pipes.

Item	Model	Ship	Net
254583	310ST-100-125	1 lbs	\$72.99



### LEWMAR REPLACEMENT DRAGLINK ROD END FITTING

- AHFT10 stainless steel
- Sold (1) per package
- For Lewmar Cobra steering systems

Item	Model	Ship	Net
600515	82000356	1 lbs	\$64.99



### LEWMAR SHIFT CONTROL MECHANISM

- Cranked handle for use with a Whitlock pedestal

Item	Model	Ship	Net
606310	89400108	3 lbs	\$219.99



### LEWMAR RUBBER BUTTON AND PLUNGER WHEEL KIT

- Designed for Whitlock steering wheels
- Includes rubber button, plunger and glue

Item	Model	Ship	Net
001861	89800013	1 lbs	\$42.99



### LEWMAR WHITLOCK PEDESTAL MAINTENANCE KIT

- Fits Constellation 600 deluxe, Mamba 10 Series, Cobra 5R deluxe and Cobra 6R deluxe pedestals. Kit contains: seal, bearings (pr), (4) large shims, small shims, circlips (pr), woodruff key, (4) allen bolts and Loctite 603.

Item	Model	Ship	Net
614815	89400069	1 lbs	\$164.99



### EDSON PEDESTAL MAINTENANCE KIT

- For routine maintenance on your Edson pedestal. Includes: 2 snap rings, 2 shaft keys, shaft washer, Teflon grease, threadlock, maintenance guide.

Item	Model	Ship	Net
301069	312-335-400	1 lbs	\$33.99



### EDSON PEDESTAL REBUILD KIT

- For 314, 335 and 336 Edson pedestals. Includes: (2) needle bearings, (2) snap rings, Teflon grease, (3) shaft keys, drive pin, threadlock, (2) nylon washers, O-ring, shaft washer and maintenance guide.

Item	Model	Ship	Net
301070	314-335	1 lbs	\$91.99



### SPINLOCK PUSHBUTTON, TELESCOPIC TILLER EXTENSIONS

- Reduces strain of helming, even in the harshest conditions. Asymmetric handle for comfort and more mobility.
- Fully universal stainless steel precision joint.
- The ultimate in ergonomic grip for improved helming performance..

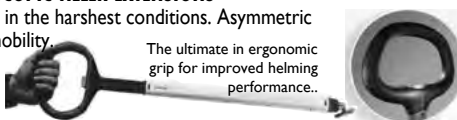

Ships direct from manufacturer.

Item	Model	Length	Ship	Net
608509	EA/900S	23-5/8" to 35-7/16"	2 lbs	\$209.99
608510	EA/1200S	29-5/8" to 47-1/4"	2 lbs	239.99

900 Joy Stick Tiller Extension - Same as Asymmetric, but with a slimmer grip.

Item	Model	Length	Ship	Net
614843	EJ/900S	23-5/8" to 35-7/16"	2 lbs	\$219.99

E-Joint Swivel - Full swivel joint with fastpin for use with E-series tiller extension

Item	Model	Length	Ship	Net
614844	E-JOINT	-	1 lbs	\$64.99

❖ For more detailed product specifications and our complete selection visit [www.defender.com](http://www.defender.com) or call 800-628-8225. ❖

## Tillers, Extensions & Accessories

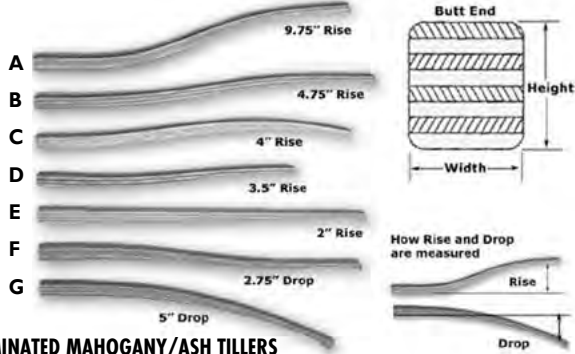

### LAMINATED MAHOGANY/ASH TILLERS

Rudder Craft tillers are laminated from alternating strips of 1/4" mahogany and ash. They are varnished with four coats of marine finish.

Item	Model	H" x W" x L"	Rise/Drop"	Ship	Net
606903	A	2 x 1.5 x 43.5	9.75	3 lbs	\$137.99
606904	B	2 x 1.5 x 47	4.75	3 lbs	137.99
606905	C	2 x 1.5 x 44	4	3 lbs	137.99
606906	D	1.75 x 1.5 x 36.5	3.5	2 lbs	132.99
606907	E	2 x 1.5 x 47	2	3 lbs	137.99
606908	F	2 x 1.5 x 47	2.75	3 lbs	137.99
606909	G	2 x 1.5 x 45	5	3 lbs	137.99

### WAVEFRONT TILLERCLUTCH & TILLERCLUTCHX KITS

TillerClutch™ lets you quickly "lash the helm" with the simple click of a lever. The X model doubles the maximum holding force on the tiller.

- Click on or click off for instant steering adjustments
- Material: Hard-anodized and tempered stainless steel
- Limited lifetime warranty



Item	Model	Boat size	Description	Ship	Net
602225	TC0001X	Over 26'	16' of Sta-Set 3/16" rope	1 lbs	\$83.99
602215	TC0001S	Up to 26'	12' of Sta-Set 3/16" rope	1 lbs	72.99

### DAVIS TILLER-TAMER™

Includes 6' of 1/4" line, instructions and screws.

Item	Model	Ship	Net
613015	2205	1 lbs	\$28.99

Like having an extra crew member.



### SCHAEFER MIDSHIPMAN II STEERING LOCK

- Suitable for any tiller-steered yacht or sports boat
- Simple mechanism allows tiller to be set and adjusted - indispensable for short-handed sailing
- Innovative design incorporates snubber that holds far better course than simply lashing tiller
- Dimensions: 5.08" L x 1.77" W x 0.92" D

Item	Model	Ship	Net
615500	19.27	1 lbs	\$100.99



### FORESPAR TILLER EXTENSIONS

Telescoping models offer foam handles and a choice of fastening devices. The TFP (Quick Release) model can be instantly fastened to the tiller by simply depressing the plunger and inserting the detent pin into the special tubular fitting supplied. The SF (Sta-Fast) patented design holds the tiller extension exactly where you leave it - no more sliding down and out of reach.

Item	Model	Description	Telescopes	Ship	Net
600020	104016	TFP-Small	19" - 32"	1 lbs	\$109.99
600021	104017	TFP-Medium	27" - 48"	1 lbs	113.99
Item	Model	Description	Cut-Out Dimensions	Ship	Net
600004	100000	Tiller Lock Box	3-3/8" W x 4-3/4" H x 1-1/2" D	1 lbs	\$35.99

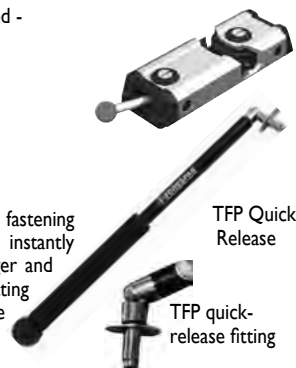

### RONSTAN TILLER EXTENSIONS

RF3128, RF3129, RF3130

All Ronstan tiller extensions are made from Black anodized aluminum tubing. The ultra light weight of these hiking sticks improves helm feel without sacrificing rigidity. All extensions in the Ronstan line feature Evalon® grips which resist moisture and have a non-slip surface.

Item	Model	Description	Length	Weight	Ship	M.A.P.
602255	RF3128	Fixed	24"	5.3 oz.	1 lbs	\$46.95
602256	RF3129	Fixed	33"	6.4 oz.	1 lbs	52.95
602257	RF3130	Fixed	41"	7.6 oz.	1 lbs	54.95
602258	RF3131	Telescoping	29"-48"	10.1 oz.	1 lbs	95.95
602259	RF3132	Telescoping	42"-70"	14.1 oz.	1 lbs	105.95
602254	RF3124	Telescoping	60"-98"	17.1 oz.	2 lbs	121.95

### RONSTAN TILLER UNIVERSAL JOINT

Used by top helmsmen to allow unrestricted, 360° tiller extension movement. Made of UV polyurethane and nylon.

Item	Model	Ship	M.A.P.
602260	RF3133	1 lbs	\$13.95



**UFLEX STEERING SYSTEMS**  
**NOW AVAILABLE AT**  
**WWW.DEFENDER.COM**



**SEASTAR STEERING HYDRAULIC SYSTEM**

SeaStar® outboard hydraulic steering system for single and multiple non-power-assisted outboard engines up to 350 hp (700 combined hp for counter-rotating duals) that have ABYC standard engine tilt tube.

- Ideal for cruisers, runabouts, center console boats, offshore fishing boats and many more
- 5 steering wheel turns lock-to-lock
- Suitable for dual station use (with purchase of extra helm, hose and fittings)
- Standard 3/4" tapered steering shaft



HK6400A

Item	Model	Ship	Net
300698	HK6400A-3	21 lbs	\$907.99

5 turns lock-to-lock

**HO51XX SERIES HOSE KITS WITH END FITTINGS**

- Replacement hoses for SeaStar hydraulic steering systems. Includes (2) hoses.
- Lengths available from 2' - 28' (even)

Item 302361

Starting at \$110.99

**SEASTAR BAYSTAR HK4200A-3 HYDRAULIC STEERING KIT**

Designed exclusively for boats with engines of 150 hp or less. For single engine/single station use only. Kit includes: (1) BayStar helm pump (HH4314-3), (1) BayStar® compact cylinder (HC4645H), (2) 20' BayStar tubing kits (HT4420H), (2) containers hydraulic steering fluid (HA5430) and filler kit.



Item	Model	Ship	Net
302986	HK4200A-3	23 lbs	\$622.99

5 turns lock-to-lock

**SEASTAR SAFE-T QUICK CONNECT STEERING SYSTEM**

The perfect kit for easy, no-tools installation.

- Simple snap-in cable connections and industry standard Safe-T mounting hardware
- For most single-station, power-assisted stern drive boats with wheels up to 16" dia.

Please specify length: 8'-20'



Item	Model	Ship	Net
303501	SS137	17 lbs	\$151.99

3 turns lock-to-lock

**SEASTAR "THE RACK" STEERING SYSTEM**

- Back-mount design allows for quick installation
- Excellent for power steered boats in which the NFB system is not required
- Works on most single-station, power assisted stern-drive boats with wheels up to 16" dia.

Please specify length: 8'-20'



Item	Model	Ship	Net
303502	SS141	14 lbs	\$159.99

4 turns lock-to-lock

**QC II SEASTAR STEERING CABLES**

- One cable fits most rotary steering systems from 1968 to present
- If you have a Safe-T QC (quick connect), NFB (no feedback) the SSC62 will replace them ALL
- If you have a Safe-T "TS" (threaded spigot) or Big-T system please order the SA27620P thread adapter in addition to the SSC62 cable below

Please specify length: 8'-20'



Item	Model	Ship	Net
301538	SSC62	11 lbs	\$106.99

Note: Longer lengths available by special order

**Quick Connect II Helm Converter for above cables**

Item	Model	Applications	Ship	Net
301479	SA27620P	Helms with threaded spigots (pre 1995)	1 lbs	\$20.99

See [www.seastarsolutions.com](http://www.seastarsolutions.com) for detailed information on choosing the right cable.

**SEASTAR STEERING SYSTEM SPARES & ACCESSORIES**

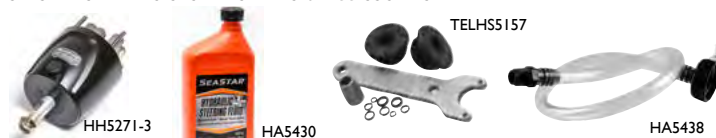

HH5271-3

HA5430

TELH55157

HA5438

Item	Model	Description	Ship	Net
300085	HH5271-3	SeaStar I standard mount hydraulic helm	6 lbs	\$434.99
303771	HA5430	SeaStar hydraulic steering fluid, quart	2 lbs	23.99
300469	HS5157	Hydraulic steering cylinder seal kit	1 lbs	117.99
300481	HA5438	SeaStar helm fill kit	1 lbs	23.99

**Lewmar Stainless Steel 3-Spoke Steering Wheel with Knob**

- 3-spoke design crafted in highly polished 316 stainless steel
- Ball-raced Power-Grip knob pre-installed
- Integrated finger grips for comfort and tactile control
- Includes wheel nut fits 1/2"-20 and 5/8"-11 threads

Item	Model	Size	Ship	Net
306519	89700820	13.5"	5 lbs	\$129.99
	89700821	15.5"	6 lbs	139.99



**Schmitt Vision Elite Steering Wheel**

- Cast 316 stainless steel center spoke
- Stainless steel finger grip rim
- Stainless steel control knob with glass ball bearings
- 3/4" tapered shaft with nut cap

Item	Model	Size	Ship	Net
305753	7161321FGK-3	13.5"	5 lbs	\$164.99
305754	7161521FGK-3	15.5"	6 lbs	169.99



**Schmitt Fantasy Steering Wheel**

- 3/4" tapered hub with a 1-1/2" hub and Black center cap
- Silver anodized finish with Black poly rim

Item	Model	Size	Ship	Net
305756	PU013101	13.8"	4 lbs	\$69.99



**Seachoice Deluxe Sport Style 13" Steering Wheel**

- Includes finger grips
- Wheel nut not included
- Diameter: 13"; Applications: Standard 3/4" tapered shaft
- Material: marine grade plastic, UV resistant

Item	Model	Size	Ship	Net
306100	28510	13"	2 lbs	\$21.99



**Schmitt Stainless Steel Destroyer Steering Wheels**

- 3/8" polished grip ring and hub cover
- Black plastic center cap and cast aluminum hub
- 15-1/2 rim, 22" dish with cap, for 3/4" tapered shafts

Item	Model	Spokes	Ship	Net
301510	1721521	5	4 lbs	\$72.99
301509	1521621	6	4 lbs	86.99



**Edson ComfortGrip Stainless Power Wheel Kits**

- Solid marine-grade 316 stainless with matching wheel nut
- Rubber finger grip on wheel rim for control and comfort
- Includes Ball Bearing Pro Series knob and wheel nut kit to fit most Teleflex and UFLEX helms (std. 3/4" tapered shafts)

Item	Model	Size	Ship	Net
303480	1710ST-13 KIT	13"	9 lbs	\$483.99
300073	1710ST-14-KIT	14.5"	9 lbs	526.99



**Edson Steering Wheel Accessories**

**EDSON STAINLESS STEEL WHEEL NUT KIT**

Item	Model	Description	Ship	Net
300024	673ST-KIT	1/2", 5/8", 12 mm or 1" thread	1 lbs	\$51.99



**EDSON PROSERIES POWERKNOB®**

- Straps to any wheel rim from 5/8" to 1-1/8"

Item	Model	Description	Ship	Net
302850	969ST-18	316 stainless steel	2 lbs	\$110.99



**EDSON SPORTSMAN SERIES™ POWERKNOB**

- Economy version of Pro Series knob. Strap on or bolt on

Item	Model	Description	Ship	Net
303127	967-18BL	Black polymer and marine-grade Stainless Steel	1 lbs	\$85.99



**Sea-Dog Motor Well Boot** All ship 1 lbs.

- Black accordion style seal organizes and protects engine control cables, wires or fuel lines.
- UV stabilized molded rubber.

Item	Model	Cable"	Dia."	Cable Openings	Net
301079	521655	9/16	5-1/2	1	\$8.49
300780	521630	3/16	3	2	1.99

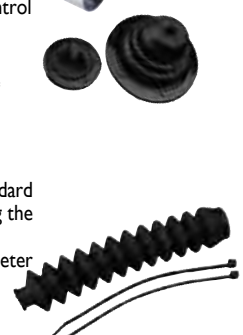

**Sea-Dog Steering Cable Boot**

Durable molded rubber boot protects the output end of all standard steering cables keeping dirt, debris and moisture out extending the service life of the cable. Includes two cable tie style clamps.

Molded rubber, 8" long, 1" diameter on one end, 3/8" diameter on other end.

Item	Model	Ship	Net
300870	521700	1 lbs	\$5.49



## Bennett Trim Tabs Systems

### Bennett Hydraulic Standard Trim Tab Kits

Reduces bow rise, plane faster, correct listing.  
Transom mount; Power: 12 Volt DC, 20 Amp

Trim Tab package contains:

- All necessary wiring, tubing, hardware and instructions
- (2) Stainless steel trim tabs • (2) Actuators
- Hydraulic power unit
- Choose from 3 controls



#### WITH EIC CONTROL

For Boats	Span	Chord	Item	Model	Ship	Net
15' - 19'	12"	9"	305637	129EIC	24 lbs	\$673.99
19' - 24'	18"	9"	305638	189EIC	27 lbs	714.99
22' - 27'	24"	9"	305639	249EIC	29 lbs	736.99
25' - 30'	30"	9"	305640	309EIC	35 lbs	754.99
19' - 24'	12"	12"	305641	1212EIC	28 lbs	713.99
22' - 27'	18"	12"	305642	1812EIC	28 lbs	736.99
25' - 30'	24"	12"	305643	2412EIC	34 lbs	748.99
25' - 30'	30"	12"	305644	3012EIC	39 lbs	772.99

#### WITH EURO ROCKER CONTROL

Item	Model	Ship	Net
301080	129E	24 lbs	\$534.99
301081	189E	27 lbs	566.99
301083	249E	28 lbs	585.99
301085	309E	33 lbs	607.99
301082	1212E	27 lbs	566.99
301084	1812E	28 lbs	585.99
301087	2412E	32 lbs	603.99
301086	3012E	37 lbs	625.99

WITH AUTOTRIM PRO (ATP) CONTROL: CALL FOR PRICING AND AVAILABILITY

### Bennett Trim Tab Accessories

#### AUTO TRIM PRO (ATP) ALL-IN-ONE AUTO TRIM TAB CONTROL SYSTEMS

- Reduce bow rise, plane faster, correct listing – automatically!
  - Compatible with Bennett, and most non-Bennett trim tab systems
  - 2 favorite settings for auto control. Take manual control any time
- Hydraulic Item 306059 AP000A1HA Ship 3 lbs Net \$491.99  
Electric Item 306060 AP000A1BC 3 lbs 491.99



#### ELECTRONIC FLUSH MOUNT INDICATOR CONTROL KIT

- Compatible with all Bennett trim tabs
  - Power: 12 Volt DC; Draw: 20 Amps
  - Reduces the number of wires run to helm
- Item 303806 EIC5000 Ship 4 lbs Net \$325.99



#### EURO-STYLE ROCKER SWITCH CONTROL

- Dimensions: 2.81" x 2.81"
  - Power: 12 Volt DC; Draw: 20 Amps
  - Fits into any existing Bennett 2-1/2" rocker switch hole
- Item 300259 ES2000 Ship 1 lbs Net \$79.99



#### HYDRAULIC POWER UNIT

- Includes (2) solenoid valves; Power: 12 Volt DC; Draw: 18 Amps
  - Creates hydraulic pressure to lower and raise the trim tabs
  - Dimensions: 4" x 7-1/2" x 5-1/2"
- Item 301111 V351HPU1 Ship 6 lbs Net \$289.99



## BOLT

Electric Trim Tab Systems

BENNETT MARINE  
Bennett Trim Tabs.com

Available at Defender.com

Multiple tab sizes and control options available

### Lenco Trim Tabs

#### STANDARD & EDGE MOUNT

- 12 Volt DC actuators (2) with 6' leads and Deutsch connectors
- Stainless steel trim tab blades (2)
- 20' actuator extension harnesses (2) with Deutsch connectors
- Upper mounting brackets (2) with gland seal
- Lower mounting brackets (2)
- All stainless steel mounting hardware
- Switches sold separately



Item	Model	Boat Length	Length in Meters	Tab Size	Ship	Net
305278	15001-101	16'-25'	4.87 - 7.62	9" x 12"	17 lbs	\$427.99
305279	15007-101	17'-30'	5.18 - 9.14	12" x 12"	20 lbs	433.99
305283	15016-101	17'-30'	5.18 - 9.14	12" x 12" Edge	20 lbs	462.99

#### LENCO DIGITAL AUTO GLIDE KIT WITHOUT GPS ANTENNA OR NETWORK - SINGLE ACTUATOR

- Applications: All engines with existing NMEA 2000 Network (except Volvo)
  - Boat must have Lenco single trim tab system with Lenco electric actuator
  - Automatically controls trim tabs for the most efficient running angle
- Item 305813 Model 15504-101 Ship 4 lbs Net \$953.99



**NEW!**

FOR ADDITIONAL ACCESSORIES PLEASE VISIT WWW.DEFENDER.COM

## ZIPWAKE

The new, dynamic trim-control system that's set to revolutionize the boat world. Featuring an advanced, intuitive control system and a stunning new innovative design, Zipwake delivers a more comfortable ride, better performance and improved fuel consumption – whatever the conditions.

### StingRay™ Hydrofoil Stabilizer

#### CLASSIC JUNIOR AND SENIOR



OUR BEST SELLING HYDROFOIL!

StingRay Classic Junior provides smaller boats with smaller engines the ability to get on plane quicker, increasing performance. It fits engines as small as 9.8 hp. The Classic Senior is designed for outboards 40 hp to 300. Both models get boats on plane quicker, keeps them on plane at lower speeds, improves holeshots, maximizes stabilization, saves fuel and reduces chinewalking, porpoising, cavitation and ventilation.



#### JUNIOR - FOR ENGINES UNDER 40 HP

Item	Description	Specify Color	Ship	M.A.P.
300045	StingRay classic junior	Black, Gray or White	2 lbs	\$54.95
300046	StingRay classic senior	Black, Gray or White	4 lbs	\$59.95

#### STINGRAY STARFIRE HYDROFOIL STABILIZER

The Starfire can be installed with no drilling required, or can be installed with the drill method if preferred for stronger installation. Designed for 40 HP models and higher, this model is engineered to maximize top end speed by inverting its trailing edge to reduce drag and extending the wing tips to enhance stabilization.

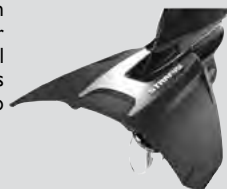

- Fits most outboards and sterndrives 40 HP and up
  - Specify Color: Black, Gray or White
- Item 301043 Ship 4 lbs M.A.P. \$99.95

### Davis Doelfin Hydrofoil

Increases steering control, saves you 30% on fuel and is simple to install. Allows you to plane off in 1/2 the time and plane at a lower RPM. Lifetime warranty.



Item	Model	Color	Ship	Net
302582	440	Black	3 lbs	\$32.99

### Nauticus Smart Tabs ST\*

Self-adjusting, speed-regulated trim tabs for fishing, cruising and inflatable boats

- No hydraulics or electric switches • Stainless steel components
- Once the water pressure exceeds the actuator load rating, the trim plates move to a horizontal position eliminating any drag. Provides remarkable stability in turns, while crossing waves, while cruising and while running at maximum speeds. No more sliding, porpoising or chine walking!



Item	Model	Boat Length	HP rating	Plate Size/Actuator	Ship	Net
302761	ST780-20	10'-12'	8 to 15	7" x 8" / 20 lbs	4 lbs	\$119.99
302762	ST780-30	10'-12'	20 to 25	7" x 8" / 30 lbs	4 lbs	119.99
302763	ST980-30	13'-15'	30 to 40	9" x 8" / 30 lbs	5 lbs	135.99
302764	ST980-40	12'-16'	40 to 80	9" x 8" / 40 lbs	5 lbs	135.99
302765	ST1290-60	15'-18'	60 to 150	12" x 9" / 60 lbs	7 lbs	179.99
302766	ST1290-80	18'-22'	150 to 240	12" x 9" / 80 lbs	7 lbs	179.99

#### TRIM TAB REPLACEMENT GAS ACTUATOR— Sold each.

Please specify pressure (20, 30, 40, 60 or 80 lbs)

Item	Description	Ship	Net
303575	For ST Series	1 lbs	\$29.99



### Smart Tabs for 10'-12' Inflatables\*

Composite trim plates designed for soft bottom inflatable tenders. Smooth radius edges and corners eliminate the risk of abrasion when the boat is stowed.

Item	Model	HP rating	Plate Size/Actuator	Ship	Net
303131	ST781-20	8 to 15	7" x 8" / 4 lbs	4 lbs	\$119.99

### Nauticus Smart Tabs SX\*

The SX series incorporates all of the fully automatic features of the popular SMART TABS in addition to the rust and corrosion free benefits of molded composite materials.

- Performance Benefits**
- Smoother and faster acceleration
  - 40% less bow rise and 35% lower on plane speed
  - More top speed and no porpoising or chinewalking
  - Improves handling and smoother ride in any water
  - Improved fuel economy (11% +)

No Maintenance!



\*For proper selection, please visit www.defender.com and use the Nauticus Selector Guide on the product pages.

#### Assembly and Installation in Minutes

- Assembly and mounting requires only a drill, a 3/16" bit and a Phillips screwdriver
- Integral design eliminates need for wrenches, and components "lock" together with self-locking clevis pins

**Rugged Design:** Thermo molded co-polymer composite material provides superior strength and resilience. Rust and corrosion are eliminated so there is no need for anodes.

**Please Specify Color:** Black or White

Item	Model	Boat Length	HP rating	Plate Size/Actuator	Ship	Net
305886	SX9510-40	12' - 16'	40 - 80 HP	9.5" x 10" / 40 lbs	4 lbs	\$127.99
305887	SX9510-60	15' - 18'	60 - 150 HP	9.5" x 10" / 60 lbs	4 lbs	127.99
305888	SX9510-80	16' - 20'	150 - 240 HP	9.5" x 10" / 80 lbs	4 lbs	127.99

#### TRIM TAB REPLACEMENT GAS ACTUATOR—Sold each.

Please specify pressure (30, 40, 60 or 80 lbs)

Item	Description	Ship	Net
303576	For SX Series (Includes protective boot)	1 lbs	\$29.99





### SE Standard - On/Off

Side-Power thrusters give you the confidence to control your boat like a pro!

- 5-Blade Q-Prop for powerful, quiet operation
- Up to 3 minute continuous running time
- Lifetime lubricated, sealed gearleg design
- Gearleg is isolated from motor and motor bracket to protect against galvanic corrosion (SE80 and up)
- Intelligent Power Control (IPC) protects the thruster solenoids from damage caused by low-voltage or power faults



Item	Model	Boat Size*	HP	Thrust lbs	Voltage	Ship	M.A.P.
303990	SE30/125S	20-28'	2	66	12V	21 lbs	\$1452.50
303991	SE40/125S	26-34'	3	88	12V	22 lbs	1522.50
305669	SE60/185S	29-38'	4	132	12 or 24V	30 lbs	1890.00
305671	SE80/185T	35-48'	6	176	12 or 24V	44 lbs	2695.00
305673	SE100/185T	40-55'	8.4	220	12 or 24V	68 lbs	3640.00

\* Hull displacement, wind speed and boat length all need to be factored into the sizing process. Contact Imtra at (508)995-7000 for a custom analysis specific to your boat.



#### CONTROL PANELS

Side-Power offers a variety of control panels to customize your installation. All feature a round cutout for easy installation and no exposed fasteners for a clean, professional appearance. All ship 1 lbs.

Item	Model	Description	Net
303156	SM8950G	Touchpanel (Square face)	\$152.99
303733	SM8955G	Touchpanel; round chrome bezel	M.A.P. 182.00
303157	SM8960G	Joystick panel	224.99
303734	SM8965	Boatpanel; round chrome bezel	M.A.P. 245.00
303735	SM8940G	Dual joystick panel (Bow and stern)	389.99

#### RADIO REMOTE CONTROL KIT

Plug and play addition to any existing Side-Power thruster system. Waterproof. Max range is 50-80 meters. All ship 2 lbs.

Item	Model	Description	Net
302233	SMRC-21U	For bow thruster and windlass	\$499.99
306520	SMRC-20U	For bow and stern thrusters	M.A.P. 499.99



### SEP Speed Controlled Thrusters

Side-Power's new range of proportional speed control DC thrusters allows you to control the power you need for precise boat movements in any weather and sea conditions.

Aside from the added control, the ability to run the thruster at less than full power extends the usable run time. The extended run time is put to good use in the Hold function incorporated in the new PJC212 panel.

DC Speed Control systems contains three main elements all tied together with the new S-link control system

- 1 Proportional control panel
- 2 Power control unit\*
- 3 DC electric thruster\*

\* Included in package

Item	Model	Boat Size*	HP	Thrust lbs.	Voltage	Ship	M.A.P.
305668	SEP40/125S	26-34'	3	88	12V	22 lbs	\$3759.00
305670	SEP60/185S	29-38'	4	132	12 or 24V	30 lbs	3969.00
305672	SEP80/185T	35-48'	6	176	12 or 24V	44 lbs	4648.00
305674	SEP100/185	40-56'	8.4	220	12 or 24V	68 lbs	5547.50
305676	SEP120/215T-24V	42-60'	8.5	264	24V	73 lbs	5824.00

\* Hull displacement, wind speed and boat length all need to be factored into the sizing process. Contact Imtra at (508)995-7000 for a custom analysis specific to your boat.



#### PROPORTIONAL CONTROL PANEL

The new PJC control panels allow you to monitor the remaining run time, voltage and amp draw.

- The PJC212 features a hold-function which allows the user to keep the boat in position at dock or in locks with a single press of a button

Item	Model	Ship	M.A.P.
305705	PJC211 Single joystick	1 lbs	\$752.50
305704	PJC212 Dual joystick	1 lbs	805.00

- S-Link Cable components and Auto-Main switch complete the system and can be found at defender.com

**MOST ON-OFF THRUSTERS CAN BE UPGRADED TO THE SIDE-POWER SPEED CONTROL SYSTEM.**

**CONTACT DEFENDER AT 800-628-8225 FOR MORE INFORMATION.**

Visit [defender.com](http://defender.com) for a complete listing of parts and accessories



### Vetus Bow Thrusters



- High efficiency motors
- A single propeller creates less flow disturbance in the tunnel
- Unique propeller blade design minimizes cavitation noise
- Flexible coupling between tail piece and motor eliminates vibration
- Streamlined tail piece for optimum flow
- Strong synthetic propeller eliminates corrosion and reduces weight
- Equal thrust in either direction
- Easy installation with clear installation and operation instructions

\* Please choose: 12 VDC or 24 VDC

Item	Model	HP	Thrust lbs	Tunnel Dia.	Ship	M.A.P.
306581	BOW2512E	2	55	4-21/64"	26 lbs	\$1606.50
306582	BOW3512E	2	77	5-29/32"	29 lbs	1759.50
305883	BOW4512D	4	99	4-59/64"	37 lbs	1912.50
305843	BOW55*	4	121	5-29/32"	38 lbs	2122.88
305847	BOW60*	4	132	7-9/32"	39 lbs	2180.25
305849	BOW75*	6	165	7-9/32"	42 lbs	2513.06
305853	BOW95*	8	210	7-9/32"	56 lbs	3595.50
305857	BOW125*	8	275	9-7/8"	74 lbs	4226.63

### Vetus Bow Thrusters (Proportional Control)

- Precision proportional control at your fingertips
- CAN based/digital control for easier interfacing with the latest joystick docking systems
- Electronic switching for improved reliability
- Endurance rated runtime
- Over-temp and low-battery protection
- When paired with the BPPJA panel (Sold separately), single person docking is an option



Tunnel Sold Separately

Item	Model	Boat Sizes	Thrust lbs	HP	Tunnel-center line	VDC	Ship	Net
306567	BOWA0301	20'-25'	66	2	110mm	12	50 lbs	\$2154.99
306568	BOWA0361	23'-28'	80	2	125mm	12	50 lbs	2354.99
306569	BOWA0421	25'-30'	93	4	125mm	12	50 lbs	2599.99
306570	BOWA0572	28'-34'	125	4	150mm	24	55 lbs	2834.99
306571	BOWA0651	34'-36'	143	4	185mm	12	55 lbs	2999.99
306572	BOWA0762	35'-39'	167	6	185mm	24	60 lbs	3324.99
306573	BOWA0902	40'-44'	198	8	185mm	24	65 lbs	4289.99



### LEWMAR®

#### Lewmar TT Bow Thruster Kits

TAKE CONTROL. ENJOY YOUR BOATING.

As marinas get smaller and slips get tighter, safely docking a boat is more challenging than ever. Thrusters give you total control of your boat and allow you to maneuver into and out of tight spots with ease. Lewmar offers a complete range for boats from 19 to 80 feet.

Choose from our popular kits listed below or visit [www.Defender.com](http://www.Defender.com) for our complete selection.

#### 110TT THRUSTER KIT

- Includes thruster, 750 mm tunnel, joystick, 7 m cable and fuse
- For boats 19-28' • 2HP; 62 lbs thrust; 12 VDC

#### 140TT THRUSTER KIT - GEN 2

- Includes thruster, 1 m tunnel, joystick controller, 7 m cable and fuse.
- For boats 28-40' • 3HP; 92 lbs thrust; 12 VDC

#### 185TT THRUSTER KIT - GEN 2

- Includes thruster, joystick controller, 10 m cable and fuse - choose tunnel below
- For boats 30-45' • 4HP; 128 lbs thrust; 12 VDC

#### TUNNEL FOR 185TT

Item 000253	589301	1 m tunnel	Ship 19 lbs	\$254.99
Item 000150	589302	1.5 m tunnel	Ship 27 lbs	379.99

#### LEWMAR ACCESSORIES

Item	Model	Description	Ship	Net
001659	68000968	5-Button windlass/thruster wireless remote control kit	1 lbs	\$399.99
001660	68000969	Remote antenna kit; 32.8" L (10 M)	1 lbs	84.99
000371	589150	Thruster anode kit for 140TT thrusters	1 lbs	\$17.99
000642	589350	Anode kit for Lewmar 185TT bow thruster	1 lbs	18.99
602148	589351	Replacement thruster propeller for 185TT thrusters	1 lbs	66.99
306516	589223	Single pad thruster control assembly	1 lbs	159.99
306517	589268	Single joystick thruster control	1 lbs	233.99
306518	589267	Dual joystick thruster control	1 lbs	419.99



## Samson 3 Strand Nylon Line

### Pro-Set Premium Nylon Dock and Anchor Lines

Samson Pro-Set Premium 3-strand nylon line combines premium quality nylon, a 4-stage manufacturing process and heat stabilization to produce a truly premium 3-strand rope with superior abrasion resistance and long dependable service life. Color: White with Red and Green I.D. Splice: 3-Strand Class 1.



- Durable
- Heat stabilized
- High strength
- Low stretch
- Will not shrink after use
- Excellent shock mitigation
- High elasticity
- Hockle resistant
- Remains firm yet flexible with use
- Easy to handle and splice

#### SAMSON PRO-SET PREMIUM DOCK LINE WITH 12" EYE SPLICE

Item	Line Dia.	Put-Up Length	Strength (lbs)	Ship	Net	Item	Line Dia.	Put-Up Length	Strength (lbs)	Ship	Net
002152	3/8"	15'	3600	1	\$14.99	002149	1/2"	30'	6300	3	\$30.99
002150	3/8"	20'	3600	1	16.99	002131	5/8"	25'	10000	4	40.99
002108	3/8"	25'	3600	2	19.99	002132	5/8"	30'	10000	4	46.99
002151	1/2"	15'	6300	2	20.99	002562	5/8"	35'	10000	5	51.99
002147	1/2"	20'	6300	2	22.99	002141	5/8"	40'	10000	5	61.99
002148	1/2"	25'	6300	2	26.99						

#### SAMSON PRO-SET PREMIUM ANCHOR LINE WITH THIMBLE

Item	Line Dia.	Put-Up Length	Strength (lbs)	Ship	Net	Item	Line Dia.	Put-Up Length	Strength (lbs)	Ship	Net
002551	3/8"	100'	3600	6	\$56.99	002558	1/2"	300'	6300	24	\$240.99
002552	3/8"	150'	3600	8	78.99	002559	5/8"	150'	10000	21	204.99
002553	3/8"	200'	3600	9	99.99	002560	5/8"	200'	10000	27	256.99
002554	1/2"	100'	6300	10	97.99	002561	5/8"	250'	10000	31	318.99
002555	1/2"	150'	6300	14	131.99	002116	5/8"	300'	10000	36	364.99
002556	1/2"	200'	6300	17	172.99						

### Samson Nylon Pro-Set 3-Strand

Sold per foot (600' spools).

Item	Line Dia.	Strength	Weight/100 Ft	Net/Ft
002120	1/4"	1600 lbs	1.5 lbs	\$0.20
002121	5/16"	2600 lbs	2.5 lbs	0.35
002129	3/8"	3600 lbs	3.5 lbs	0.45
002291	1/2"	6300 lbs	6.3 lbs	0.80
011693	9/16"	7900 lbs	8.1 lbs	1.05
002123	5/8"	10000 lbs	10.5 lbs	1.25
002124	3/4"	13500 lbs	14.5 lbs	1.65
002260	1"	25000 lbs	26 lbs	2.95



### Samson Splicing Kit

Contains five tubular fids for splicing lines of 1/4", 5/16", 3/8", 7/16", 1/2", plus a pusher and instructions for the standard eye splice. Comes in a convenient pouch.

Item	Ship	Net
001242	1 lbs	\$48.99



### Samson Splicing Manual

• Comprehensive splicing manual covering over 30 different splices for 6 types of rope construction • Full color Samson rope identification chart • Color rope retirement visual inspection guide • Information on splicing tools, lock stitching, whipping, seizing cover stripping and installation • Glossary • Updated in 2017

Item	Ship	Net
050452	1 lbs	\$21.99



### Samson Splicing Tools - Aluminum Tubular Fid

Item	Model	Rope Size	Use Pusher	Ship	Net
001243	901016000000	1/4"	Small	1 lbs	\$6.49
001244	901020000000	5/16"	Small	1 lbs	6.49
001245	901024000000	3/8"	Small	1 lbs	6.49
002877	901028000000	7/16"	Small	1 lbs	8.99
001246	901032000000	1/2"	Small	1 lbs	8.99
001247	901036000000	9/16"	Large	1 lbs	12.99
001248	901040000000	5/8"	Large	1 lbs	13.99
001249	901048000000	3/4"	Large	1 lbs	18.99
001250	901056000000	7/8"	Large	1 lbs	20.99
001251	901064000000	1"	Large	1 lbs	26.99

#### SAMSON PUSHER TOOL

001252	913000000000	Small pusher	1 lbs	\$7.99
001253	914000000000	Large pusher	1 lbs	13.99

## Samson Double Braid Nylon Line

### Super Strong Nylon Line

Samson's strongest dock and anchor line is a firm but flexible double braid made from high-tenacity nylon fiber treated with Pro-Gard marine finish maximizing wet wear life and strength. Much stronger than 3-strand; 20% stronger than other braided nylon ropes. Color: White with Red and Blue tracer Splice: Double braid Class 1



#### Features:

- Durable
- Firm construction
- Remains flexible with use
- Excellent shock mitigation
- Pro-Gard marine finish
- Shrink resistant

#### Applications:

- Anchor line
- General working line/vessel mooring lifting sling/utility
- Mooring pendant
- Secondary mooring line
- Tug pendant
- Dock line
- Other fishing line
- Shock line

#### WHITE WITH RED AND BLUE I.D.

• Sold per foot (600' spools)

Item	Model	Size	Strength (lbs)	Ship/Ft	Net/Ft
013046	472032006030	1/2"	8600	1 lbs	\$1.05
013047	472040006030	5/8"	15200	1 lbs	1.75
013048	472048006020	3/4"	18800	1 lbs	2.20
013049	472064006020	1"	36000	1 lbs	3.65

#### SAMSON PRE-SPICED SUPER STRONG DOCK LINE

12" Eye • Color: White with Red and Blue I.D.

Item	Line Dia.	Put-Up Length	Strength (lbs)	Ship	Net	Item	Line Dia.	Put-Up Length	Strength (lbs)	Ship	Net
002250	3/8"	15'	4700	1	\$18.99	002972	1/2"	30'	8600	3	\$41.99
002251	3/8"	20'	4700	2	20.99	002970	1/2"	35'	8600	3	45.99
002252	3/8"	25'	4700	2	24.99	002241	5/8"	20'	15200	4	47.99
002971	1/2"	15'	8600	2	28.99	002973	5/8"	25'	15200	4	58.99
002253	1/2"	20'	8600	2	31.99	002242	5/8"	30'	15200	5	63.99
002254	1/2"	25'	8600	2	37.99	002243	5/8"	35'	15200	5	72.99

### Solid Color Double Braid Nylon

Flexible, shock absorbing double braid that resists rot and mildew. Stronger than 3-strand nylon. Choose color: Black, Blue or Navy.

Double Splice: Braid Class 1

#### Features:

- Flexible
- Long service life
- Mitigates shock
- Resists rot, mildew, mold and most chemicals

#### SOLID BLACK

Sold per foot (600' spools)

Item	Model	Size	Strength (lbs)	Ship/Ft	Net/Ft
013050	469032206030	1/2"	7900	1 lbs	\$1.50
013051	469040206020	5/8"	14000	1 lbs	2.10
013052	469048206020	3/4"	18500	1 lbs	2.95



#### SAMSON PRE-SPICED SOLID COLOR DOCK LINE

12" Eye • Please specify: Black, Blue or Navy

002588	3/8"	15'	4500	1	\$19.99	002591	5/8"	20'	14000	3	\$54.99
002589	3/8"	20'	4500	1	22.99	002594	5/8"	25'	14000	4	58.99
002915	3/8"	25'	4500	2	24.99	002590	5/8"	30'	14000	5	64.99
002968	1/2"	15'	7900	2	28.99	002593	5/8"	35'	14000	5	72.99
002587	1/2"	20'	7900	2	33.99	002595	5/8"	40'	14000	6	96.99
002966	1/2"	25'	7900	2	38.99	002207*	3/4"	40'	18500	7	122.99
002967	1/2"	30'	7900	3	44.99	002208*	3/4"	45'	18500	8	132.99
002969	1/2"	35'	7900	3	49.99	002582*	3/4"	50'	18500	8	159.99

3/4" x 40', 3/4" x 45' and 3/4" x 50' available in Black only with 18" eye.

### Super Strong Nylon Anchor Line WITH CAPTIVE THIMBLE ONE END

Available in attractive White body with Blue and Red I.D. pattern. Same construction and characteristics of Super Strong dock lines. Includes a spliced eye with captive thimble on one end. The SOS thimble is constructed of a high strength, synthetic Black plastic material that will not rust and chafe the line. The thimble may be attached to any galvanized or stainless steel shackle for use with anchors or chain.



Item	Line Dia.	Put-Up Length	Strength (lbs)	Ship	Net	Item	Line Dia.	Put-Up Length	Strength (lbs)	Ship	Net
002109	3/8"	100'	4700	6	\$84.99	002114	1/2"	250'	8600	20	\$239.99
002606	3/8"	150'	4700	8	99.99	002113	1/2"	300'	8600	25	279.99
002607	3/8"	200'	4700	9	134.99	002610	5/8"	150'	15200	21	264.99
002110	1/2"	100'	8600	9	109.99	002609	5/8"	200'	15200	29	334.99
002111	1/2"	150'	8600	13	154.99	002608	5/8"	250'	15200	35	399.99
002112	1/2"	200'	8600	16	194.99	002119	5/8"	300'	15200	40	469.99

For more splicing accessories, see page 51.

For more detailed product specifications and our complete selection visit [www.defender.com](http://www.defender.com) or call 800-628-8225.

## Dock Lines & Anchor Lines

### Buccaneer Double Braid Dock Lines

- Up to 3/4" dock lines come with a 12" spliced eye
- 3/4" has 18" spliced eye

Double braid dock and anchor lines feature:

- 100% nylon
- Will not kink or hockle
- Will not fade or stain decks
- Combines high strength and good shock absorption

MADE IN USA



### Buccaneer Double Braid Anchor Lines

- Comes with a Stainless Steel thimble pre-spliced on one end



#### Buccaneer Double Braid Specifications

Dia.	Tensile Strength	Weight/100'	Dia.	Tensile Strength	Weight/100'
3/8"	4900 lbs	3.6 lbs	5/8"	15200 lbs	10.0 lbs
1/2"	8500 lbs	6.3 lbs	3/4"	18000 lbs	14.3 lbs

#### White

Item	Size	Ship	Net	Item	Size	Ship	Net
001685	3/8" x 15'	1 lbs	\$15.99	001690	1/2" x 30'	3 lbs	\$25.99
001686	3/8" x 20'	1 lbs	16.99	001691	5/8" x 25'	3 lbs	31.99
001687	3/8" x 25'	2 lbs	18.99	001692	5/8" x 35'	4 lbs	40.99
001688	1/2" x 20'	2 lbs	20.99	001693	5/8" x 40'	5 lbs	44.99
001689	1/2" x 25'	2 lbs	23.99				

#### Gold/White

Item	Size	Ship	Net	Item	Size	Ship	Net
001694	3/8" x 15'	1 lbs	\$15.99	001700	5/8" x 25'	3 lbs	\$34.99
001695	3/8" x 20'	1 lbs	17.99	001701	5/8" x 35'	4 lbs	47.99
001696	3/8" x 25'	2 lbs	18.99	001702	5/8" x 40'	5 lbs	49.99
001697	1/2" x 20'	2 lbs	21.99	001703	3/4" x 35'	6 lbs	61.99
001698	1/2" x 25'	2 lbs	24.99	001704	3/4" x 40'	7 lbs	78.99
001699	1/2" x 30'	3 lbs	27.99	001705	3/4" x 50'	9 lbs	90.99

#### Blue, Hunter Green or Black

Item	Size	Ship	Net	Item	Size	Ship	Net
001706	3/8" x 15'	1 lbs	\$16.99	001711	1/2" x 30'	3 lbs	\$30.99
001707	3/8" x 20'	1 lbs	18.99	001712	5/8" x 25'	3 lbs	38.99
001708	3/8" x 25'	2 lbs	19.99	001713	5/8" x 35'	4 lbs	48.99
001709	1/2" x 20'	2 lbs	23.99	001714	5/8" x 40'	5 lbs	61.99
001710	1/2" x 25'	3 lbs	26.99				

#### Black Only

Item	Size	Ship	Net	Item	Size	Ship	Net
003418	3/4" x 15'	4 lbs	\$40.99	003418	3/4" x 35'	6 lbs	72.99
	3/4" x 20'	4 lbs	47.99		3/4" x 40'	7 lbs	78.99
	3/4" x 25'	5 lbs	58.99		3/4" x 50'	9 lbs	96.99

### New England Ropes Premium 3-Strand Nylon

Long wearing, supple and easy to handle. Manufactured from premium grade high tenacity nylon fiber treated with proprietary Marine-Tech coating to provide excellent abrasion resistance. **Please specify:** Black or Navy **Applications:** Dock lines, anchor lines, mooring lines



Item	Dia.	Tensile	Weight/100'	Net/Ft
000366	3/8"	4250	3.5 lbs	\$0.63
000365	1/2"	7500	6.3 lbs	1.09
000364	9/16"	8800	8.0 lbs	1.29
000363	5/8"	11650	9.6 lbs	1.49
000362	3/4"	17150	13.7 lbs	1.89

#### White

Item	Size	Ship	Net	Item	Size	Ship	Net
001805	3/8" x 100'	4 lbs	\$52.99	001808	1/2" x 150'	11 lbs	\$123.99
001806	3/8" x 150'	6 lbs	78.99	001809	5/8" x 200'	24 lbs	241.99
001807	1/2" x 100'	4 lbs	82.99				

#### Gold/White

Item	Size	Ship	Net	Item	Size	Ship	Net
001810	3/8" x 100'	4 lbs	\$58.99	001813	1/2" x 150'	10 lbs	\$134.99
001811	3/8" x 150'	6 lbs	86.99	001815	5/8" x 200'	24 lbs	277.99
001812	1/2" x 100'	7 lbs	90.99				

#### Black, Blue or Hunter Green

Item	Size	Ship	Net	Item	Size	Ship	Net
001816	3/8" x 100'	4 lbs	\$67.99	001819	1/2" x 150'	10 lbs	\$134.99
001817	3/8" x 150'	7 lbs	91.99	001820	5/8" x 200'	24 lbs	273.99
001818	1/2" x 100'	7 lbs	93.99				

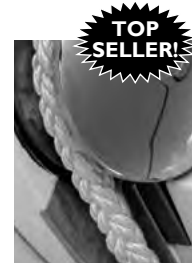

### Buccaneer 8 Strand Plaited Rope

- Runs tangle-free
- Applications: windlasses, anchor, mooring and dock, etc.

Item	Color	Dia.	Spool	Tensile	Wt/100'	Net/Ft
002677	White	1/2"	1800	6400	7 lbs	\$0.92
	White	9/16"	1200	7700	8 lbs	1.12
	White	5/8"	1200	11000	11 lbs	1.23
	White	3/4"	1000	17000	15 lbs	1.75
	White	1"	1200	31000	28 lbs	3.18
002675	Black	1/2"	1800	6400	7 lbs	1.02
	Black	5/8"	1200	11000	11 lbs	1.53
	Black	3/4"	1000	17000	15 lbs	2.26

### New England Ropes White 8 Plait Nylon

Primarily designed as an anchor line for mechanical windlasses. Combining newest braiding technology and optimizing for anchor line use, 8 plait nylon rope splices and works in most common gypsies. NER 8 Plait has a high energy absorption and good abrasion resistance built in. The single braid construction delivers a balanced rope that coils and flakes easily into most anchor lockers. Other uses include dock and mooring lines for sail and power.

Item	Model	Diameter	Average Breaking Strength (Tensile)	Weight per 100'	Net/Ft
003376	C1340-16	1/2"	8,000 lbs	6.3 lbs	\$0.95
	C1340-18	9/16"	9,500 lbs	8.0 lbs	1.09
	C1340-20	5/8"	10,400 lbs	9.2 lbs	1.29

## Rope/Chain Rodes

Our exclusive Defender rodes are windlass ready and professionally back spliced to the best American made chain (ACCO/PEERLESS). Please check windlass manufacturer specs for suitability.



### 3 STRAND ANCHOR RODES

Made from premium 3-strand, medium lay rope professionally spliced to high quality ACCO chain.

Item	Model	Chain Size	Chain Type	Chain Length	Rope Size	Rope Length	Ship	Net
011940	CRR09	1/4"	G4 Hi-Test	15'	1/2"	150'	23 lbs	\$184.99
001385	RCR02	5/16"	G4 Hi-Test	15'	9/16"	150'	30 lbs	209.99
001386	RCR04	5/16"	G4 Hi-Test	20'	9/16"	200'	39 lbs	259.99
001515	RCR11	5/16"	G4 Hi-Test	20'	5/8"	200'	45 lbs	304.99
001516	RCR12	5/16"	G4 Hi-Test	30'	5/8"	250'	58 lbs	379.99
001387	RCR05	3/8"	BBB	20'	9/16"	200'	50 lbs	288.99

**Suggested Chain Length:** a minimum 6" of chain is suggested for each foot of boat, although 1' of chain for each foot is preferred (common rule of thumb for average displacement boats in average conditions).

### Lewmar Rope/Chain Anchor Rodes

Each rode comes with a shackle to attach the chain to the anchor. The 3-strand tapered eye splice ensures a smooth transition from rope to chain around the windlass gypsy.

Item	Model	G4 Chain	3-Strand Rope	Ship	Net
000525	69000331	5' 1/4"	100' 1/2"	13 lbs	\$175.99
000526	69000332	10' 1/4"	150' 1/2"	21 lbs	211.99
000527	69000338	15' 5/16"	150' 9/16"	30 lbs	316.99
000528	69000339	20' 5/16"	200' 9/16"	40 lbs	374.99



### 8 STRAND PLAITED ANCHOR RODES

8-Plait rope carries similar tensile strength as 3-strand but handles easier and stows in much less space than 3-strand line. It eliminates hocking and kinking and has no memory.

Item	Model	Chain Size	Chain Type	Chain Length	Rope Size	Rope Length	Ship	Net
001896	PCR10	1/4"	G4 Hi-Test	10'	1/2"	150'	16 lbs	\$166.99
001897	PCR11	1/4"	G4 Hi-Test	15'	1/2"	200'	22 lbs	199.99
001450	PCR1	1/4"	G4 Hi-Test	20'	1/2"	230'	33 lbs	229.99
001514	PCR6	1/4"	G4 Hi-Test	25'	1/2"	275'	39 lbs	271.99
001451	PCR2	5/16"	G4 Hi-Test	15'	9/16"	235'	38 lbs	292.99
001517	PCR7	5/16"	G4 Hi-Test	20'	5/8"	225'	46 lbs	312.99
001452	PCR3	5/16"	G4 Hi-Test	30'	9/16"	270'	57 lbs	359.99
001512	PCR4	5/16"	G4 Hi-Test	30'	5/8"	220'	57 lbs	349.99
001513	PCR5	5/16"	G4 Hi-Test	30'	5/8"	270'	62 lbs	379.99
001894	PCR8	3/8"	G4 Hi-Test	30'	5/8"	300'	77 lbs	429.99
001895	PCR9	3/8"	G4 Hi-Test	50'	5/8"	300'	118 lbs	499.99

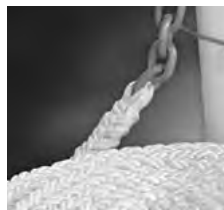

### Lewmar Premium 8 Plait Rope/Chain Rodes

- Designed to complement the rope chain gypsies on Lewmar windlasses
- Enables 50% more line in locker than 3-strand rope rode
- Eliminates hocking and kinking
- Resists stiffening with age

Item	Model	Description	Weight	Net
012155	HM10HT125PX	10' 1/4" G4 spliced to 125' 1/2" line	19 lbs	\$252.99
012156	HM10HT200PX	10' 1/4" G4 spliced to 200' 1/2" line	25 lbs	357.99
012158	HM15HT300PX	15' 1/4" G4 spliced to 300' 1/2" line	36 lbs	504.99
012157	HM15HT200PX	15' 5/16" G4 spliced to 200' 5/8" line	40 lbs	452.99
012159	HM30HT200PX	30' 5/16" G4 spliced to 200' 5/8" line	59 lbs	599.99

Custom rope/chain rodes available in any length. Please call us at 1-800-628-8225 or email rigging@defender.com



**ACCO LONG LINK M-C MOORING CHAIN**

High quality, galvanized domestic chain has 30% more zinc per unit volume than mechanical coating. The long link design permits the hook-up of shackles anywhere on the chain, not just on end links as with most chains.



Item	Link Size	Working Load	Ship/Ft.	Net/Ft.
001124	3/8"	4050 lbs	2 lbs	\$4.45
001125	1/2"	6900 lbs	3 lbs	6.35
001126	5/8"	9750 lbs	4 lbs	9.65
001127	3/4"	15000 lbs	6 lbs	14.95
001777*	1"	17900 lbs	11 lbs	28.99

\* Note: 1" is proof coil chain

**SUNCOR 316 STAINLESS STEEL ANCHOR CHAIN**

Highly resistant to corrosion, this chain can be used in fresh or salt water and is designed to fit windlasses that specify ISO grade 43 High Test (HT) chain.

• Available in cut-to-order lengths and sizes up to 5/8" by special order

Item	Size	Working Load	Breaking Strength	Ship/Ft.	Net/Ft.
011985	1/4" HT (G4)	2000 lbs	8000 lbs	1 lbs	\$9.99
012029	5/16" HT (G4)	2400 lbs	9600 lbs	1 lbs	14.99
012030	3/8" HT (G4)	3550 lbs	14200 lbs	2 lbs	20.99

**SUNCOR STAINLESS STEEL PRE-CUT CHAIN**

Item	Size	Working Load	Ship/Ft.	Net
000309	1/4" x 5'	1570 lbs	3 lbs	\$59.99
000310	5/16" x 6'	2400 lbs	6 lbs	104.99
000311	3/8" x 6'	3750 lbs	9 lbs	134.99



**BOATMAN'S PRIDE ANCHOR CHAIN IN PRE-CUT LENGTHS**

• Heavy duty, galvanized chain uncoated or with double coating of non-marring White polymer to protect decks and hulls  
• Oversized link on one end for easy hook-up • Imported

**COATED**

Item	Model	Size	Ship	Net
001118	4069-80405	1/4" x 5'	5 lbs	\$17.99
001120	4069-80506	5/16" x 6'	7 lbs	25.99

**UNCOATED**

Item	Model	Size	Ship	Net
001117	4069-40304	3/16" x 4'	2 lbs	\$14.99
001119	4069-40405	1/4" x 5'	4 lbs	19.99
001121	4069-40506	5/16" x 6'	5 lbs	29.99



**IMTRA CHAIN MARKERS**

Color-coded chain markers make it easier to keep track of chain deployment.

Item	Description	Choice of Colors (specify)	Ship	Net
012074	5/16" (10 pcs.)	Red, Yellow, Green, Blue, White	1 lbs	\$14.99
012075	3/8" (8 pcs.)	Red, Yellow, Green, Blue, White	1 lbs	14.99
012076	1/2" (8 pcs.)	Red, Yellow, Green, Blue, White	1 lbs	14.99



**SUNCOR ANCHOR SNUBBER HOOK**

• Applications: reduces load on windlass chain while anchored  
• Material: 316 stainless steel  
• Works with stainless steel and galvanized chain

Item	Model	Fits Chain Size	Ship	Net
607461	S0191-0007	1/4"	1 lbs	\$22.99
	S0191-0008	5/16"	1 lbs	39.99
	S0191-0010	3/8"	2 lbs	49.99



**SUNCOR DROP FORGED STAINLESS STEEL CHAIN GRAB HOOK**

• For use with rope lanyard to remove the load from your windlass after anchor is set  
• Not for use with BBB chain

Item	Working Load	Description	Ship	Net
003119	1500 lbs	1/4" chain size	1 lbs	\$16.99
	2000 lbs	5/16" chain size	1 lbs	20.99
	2500 lbs	3/8" chain size	1 lbs	29.99
	3600 lbs	1/2" chain size	2 lbs	61.99



**Chain Selection Guide**

• Mooring chain

A high quality carbon steel. General purpose chain with a versatile long link design. The long link makes it suited for mooring applications.

Add a shackle! Use a shackle to add on to an existing span of chain - or connect it in the middle of a span for more versatility.

- Anchor rode, no windlass
- General use

**Proof Coil Chain**  
A general utility chain good for most applications

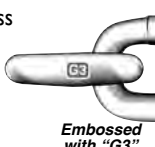

• Anchor lead chain

**Boatman's Pride**  
Protects decks and hulls  
Polymer coating  
Hot galvanized plating  
Welded steel chain

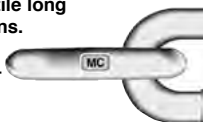

**Windlass Chain Made in the USA!**

**G-4 HI-TEST, DIN766 HI-TEST (6 MM) AND BBB CHAIN**

Hi-test has the highest strength-to-weight ratio, which permits weight reduction by using smaller chain. BBB is a general purpose chain with a compact link. Please check windlass manufacturer's specifications for correct chain and type.

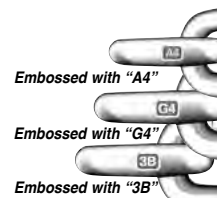

**ACCO GRADE-40 "A-4" DIN 766 6MM HI-TEST GALVANIZED WINDLASS CHAIN**

Item	Size	Working Load	Wgt./Ft.	Ship	Net
012031	6 mm	560 kg (1235 lbs)	.54 lbs	1 lbs/ft	\$2.70/ft

**G-4 HI-TEST ISO WINDLASS CHAIN**

001142	1/4"	2600 lbs	.73 lbs	1 lbs/ft	\$2.70/ft
001143	5/16"	3900 lbs	1.04 lbs	2 lbs/ft	3.40/ft
001144	3/8"	5400 lbs	1.485 lbs	2 lbs/ft	4.45/ft
002374	7/16"	7200 lbs	2.15 lbs	3 lbs/ft	6.55/ft
001150	1/2"	9200 lbs	2.54 lbs	3 lbs/ft	6.70/ft
001505	5/8"	13000 lbs	3.88 lbs	4 lbs/ft	10.85/ft
001506	3/4"	20200 lbs	5.55 lbs	6 lbs/ft	16.99/ft
012027	3/8" x 64' (pail)	5400 lbs	1.48 lbs	99 lbs	279.99
012025	5/16" x 90' (pail)	3900 lbs	.88 lbs	97 lbs	299.99
001152	5/16" x 275' (1/2 drum)	3900 lbs	.88 lbs	300 lbs	796.99
001155	3/8" x 200' (1/2 drum)	5400 lbs	1.48 lbs	324 lbs	779.99
001158	1/2" x 100' (1/2 drum)	9200 lbs	2.54 lbs	260 lbs	599.99
000105	5/16" x 550' (full drum)	3900 lbs	.88 lbs	598 lbs	1529.99
000112	3/8" x 400' (full drum)	5400 lbs	1.48lbs	642 lbs	1519.99
002373	7/16" x 300' (full drum)	7200 lbs	2.15 lbs	645 lbs	1689.99
002277	1/2" x 300' (full drum)	9200 lbs	2.54 lbs	780 lbs	1769.99
001509	5/8" x 150' (full drum)	13000 lbs	3.83 lbs	622 lbs	1329.99

**BBB WINDLASS CHAIN**

001145	1/4"	1300 lbs	.74 lbs	1 lbs/ft	\$3.35/ft
001146	5/16"	1900 lbs	1.11 lbs	2 lbs/ft	3.85/ft
001147	3/8"	2650 lbs	1.56 lbs	2 lbs/ft	4.70/ft
001148	1/2"	4500 lbs	2.74 lbs	3 lbs/ft	8.20/ft
012028	3/8" x 63' (pail)	2650 lbs	1.56 lbs	110 lbs	292.99
012026	5/16" x 92' (pail)	1900 lbs	1.11 lbs	109 lbs	349.99
001153	5/16" x 275' (1/2 drum)	1900 lbs	1.11 lbs	323 lbs	969.99
001156	3/8" x 200' (1/2 drum)	2650 lbs	1.56 lbs	320 lbs	889.99
000121	5/16" x 550' (full drum)	1900 lbs	1.11 lbs	646 lbs	1929.99
000122	3/8" x 400' (full drum)	2650 lbs	1.56 lbs	640 lbs	1749.99
001508	1/2" x 200' (full drum)	4500 lbs	2.74 lbs	576 lbs	1539.99

**G-3 PROOF COIL CHAIN**

001134	3/16"	800 lbs	.39 lbs	1 lbs/ft	\$1.30/ft
001135	1/4"	1300 lbs	.75 lbs	1 lbs/ft	2.60/ft
001136	5/16"	1900 lbs	1.12 lbs	2 lbs/ft	3.35/ft
001137	3/8"	2650 lbs	1.61 lbs	2 lbs/ft	3.90/ft
001138	1/2"	4500 lbs	2.63 lbs	3 lbs/ft	6.70/ft
001139	5/8"	6900 lbs	3.82 lbs	4 lbs/ft	8.99/ft
001140	3/4"	10600 lbs	5.52 lbs	6 lbs/ft	19.99/ft
001151	5/16" x 275' (1/2 drum)	1900 lbs	.97 lbs	308 lbs	829.99
000312	3/8" x 200' (1/2 drum)	2650 lbs	1.48 lbs	322 lbs	734.99
001157	1/2" x 100' (1/2 drum)	4500 lbs	2.64 lbs	271 lbs	645.99
000102	5/16" x 550' (full drum)	1900 lbs	.97 lbs	614 lbs	1595.99
000104	3/8" x 400' (full drum)	2650 lbs	1.48 lbs	644 lbs	1429.99
001159	1/2" x 200' (full drum)	4500 lbs	2.64 lbs	537 lbs	1269.99
001161	5/8" x 150' (full drum)	6900 lbs	3.83 lbs	654 lbs	1339.99



All ACCO chain manufactured in the USA\*

\* With the exception of the pre-cut anchor chain



	Stamp	Size	Actual Wire Size	Working Load	Approx. Boat Length
DIN766	A4	6 mm	6 mm	1235 lbs	Up to 25'
	G4	1/4"	0.276	2600 lbs	40'
	G4	5/16"	0.329	3900 lbs	54'
High Test	G4	3/8"	0.394	5400 lbs	80'
	3B	5/16"	0.343	1900 lbs	44'
	3B	3/8"	0.394	2650 lbs	54'
BBB	3B	1/2"	0.519	4500 lbs	72'
	N/A	3/16"	0.218	800 lbs	Up to 25'
	N/A	1/4"	0.276	1300 lbs	35'
Proof Coil	G3	5/16"	0.329	1900 lbs	44'
	G3	3/8"	0.394	2650 lbs	54'
	G3	1/2"	0.519	4500 lbs	72'
	G3	5/8"	0.630	6900 lbs	90'+
	MC	3/8"	0.394	4050 lbs	N/A
Mooring*	MC	1/2"	0.519	6900 lbs	N/A
	MC	5/8"	0.656	9750 lbs	N/A
	MC	3/4"	0.781	15000 lbs	N/A
Boatman's Pride	N/A	3/16"	0.218	800 lbs	18'
	N/A	1/4"	0.276	1300 lbs	28'
	N/A	5/16"	0.329	1900 lbs	40'

\* Consult your harbor master for mooring recommendations.

### Crosby Screw Pin Anchor Shackles



❖ US drop forged recommended for underwater service. ❖

G-209A US Drop Forged Alloy*				
Size	Working Load (tons)	Ship	Net	
3/16"				
1/4"				
5/16"				
3/8"	2	1 lbs	\$16.99	Item 002931
7/16"	2-2/3	1 lbs	20.99	
1/2"	3-1/3	1 lbs	24.99	
5/8"	5	2 lbs	36.99	
3/4"	7	3 lbs	49.99	
7/8"	9-1/2	4 lbs	64.99	
1"	12-1/2	6 lbs	87.99	
1-1/8"	15	8 lbs	124.99	
1-1/4"	18	10 lbs	164.99	

G-209 US Drop Forged Galvanized*				
Size	Working Load (tons)	Ship	Net	
	1/3	1 lbs	\$8.99	
	1/2	1 lbs	8.99	
	3/4	1 lbs	10.99	
	1	1 lbs	11.99	
	1-1/2	1 lbs	13.99	
	2	1 lbs	15.99	
	3-1/4	2 lbs	29.99	
	4-3/4	3 lbs	42.99	
	6-1/2	4 lbs	56.99	
	8-1/2	6 lbs	74.99	
	9-1/2	8 lbs	109.99	
	12	10 lbs	154.99	

316 Stainless Steel				
Size	Working Load (lbs.)	Ship	Net	
	500 lbs	1 lbs	\$4.99	
	750 lbs	1 lbs	5.99	
	1000 lbs	1 lbs	6.99	
	1200 lbs	1 lbs	13.99	
	1500 lbs	1 lbs	18.99	
	2500 lbs	1 lbs	25.99	
	3000 lbs	2 lbs	25.99	
	4000 lbs	2 lbs	49.99	
	5000 lbs	3 lbs	58.99	
	6000 lbs	5 lbs	81.99	
	9000 lbs	9 lbs	197.99	



**STAINLESS STEEL LOCKING WIRE**  
Generally used for securing fiberglass manifold / muffler wrap. Also is commonly used to lock shackle pins when assembling anchor rodes and mooring tackle.

Item	Model	Description	Ship	Net
755410	30085	10' coil, .032"	1 lbs	\$3.99
755411	30086	10' coil, .041"	1 lbs	3.99
755412	30087	1 lbs spool (360'), .032"	2 lbs	11.99
755413	30088	1 lbs spool (220'), .041"	2 lbs	11.99

### TITAN SCREW PIN BOW / ANCHOR SHACKLE

• Pin Type: Screw pin  
• Material: Hot dip galvanized Shackle and pin



Size	Working Load	Ship	Net
1/4"	1100 lbs	1 lbs	\$4.99
5/16"	1650 lbs	1 lbs	5.99
3/8"	2200 lbs	1 lbs	9.99
7/16"	3300 lbs	1 lbs	12.99
1/2"	4400 lbs	1 lbs	14.99
5/8"	7150 lbs	2 lbs	16.99
3/4"	10450 lbs	3 lbs	21.99
7/8"	14300 lbs	4 lbs	29.99
1"	18700 lbs	6 lbs	32.99
1-1/8"	20900 lbs	8 lbs	43.99
1-1/4"	26400 lbs	11 lbs	65.99
1-3/8"	29700 lbs	15 lbs	76.99

### TITAN SCREW PIN DEE / ANCHOR SHACKLE

• Pin Type: Screw pin  
• Material: Hot dip galvanized Shackle and pin



Size	Working Load	Ship	Net
1/4"	1100 lbs	1 lbs	\$4.99
5/16"	1650 lbs	1 lbs	5.99
3/8"	2200 lbs	1 lbs	9.99
7/16"	3300 lbs	1 lbs	12.99
1/2"	4400 lbs	1 lbs	14.99
5/8"	7150 lbs	2 lbs	16.99
3/4"	10450 lbs	2 lbs	21.99
7/8"	14300 lbs	4 lbs	29.99
1"	18700 lbs	5 lbs	32.99
1-1/8"	20900 lbs	7 lbs	43.99
1-1/4"	26400 lbs	10 lbs	65.99
1-3/8"	29700 lbs	13 lbs	76.99

### Thimbles



❖ US drop forged recommended for underwater service. ❖

Size	Ship	Net	Size	Ship	Net	Size	Ship	Net	Size	Ship	Net
1/8"			1/8"			1/8"		\$0.10	1/8"		
3/16"	1 lbs	\$2.99	3/16"	1 lbs	\$1.99	3/16"	1 lbs	0.60	3/16"	1 lbs	\$3.99
1/4"	1 lbs	3.59	1/4"	1 lbs	1.99	1/4"	1 lbs	0.60	1/4"	1 lbs	4.99
5/16"	1 lbs	3.59	5/16"	1 lbs	2.99	5/16"	1 lbs	0.71	5/16"	1 lbs	5.99
3/8"			3/8"	1 lbs	4.99	3/8"	1 lbs	0.81	3/8"		
7/16"			7/16"	1 lbs	4.99	7/16"			7/16"		
1/2"			1/2"	1 lbs	7.99	1/2"	1 lbs	1.12	1/2"	1 lbs	8.99
5/8"			5/8"	1 lbs	10.99	5/8"	1 lbs	2.25	5/8"	2 lbs	16.99
3/4"			3/4"	2 lbs	21.99	3/4"	1 lbs	2.79	3/4"	2 lbs	22.99
7/8"			7/8"	2 lbs	30.99	7/8"	2 lbs	4.69	7/8"	2 lbs	31.99
1"			1"	4 lbs	39.99	1"	2 lbs	5.69	1"	3 lbs	44.99
1-1/4"			1-1/4"	4 lbs	47.99						

### EYE-TO-EYE SWIVELS



Size	Item	Ship	Net	Item	Work Load	Ship	Net
1/4"	001469	1 lbs	10.99	002933	860 lbs	1 lbs	\$15.49
5/16"					1260 lbs	1 lbs	16.99
3/8"	001470	1 lbs	11.49		2200 lbs	1 lbs	19.99
1/2"	001471	2 lbs	15.49		3600 lbs	2 lbs	24.99
5/8"	001472	3 lbs	23.99		5200 lbs	3 lbs	42.99
3/4"	001473	4 lbs	28.99		7000 lbs	5 lbs	52.99
7/8"				003006	10000 lbs	7 lbs	139.99
1"					12500 lbs	10 lbs	169.99

### JAW-TO-EYE SWIVELS



Size	Work Load	Ship	Net
1/4"	860 lbs	1 lbs	\$18.99
5/16"	1260 lbs	1 lbs	19.99
3/8"	2200 lbs	1 lbs	22.99
1/2"	3600 lbs	2 lbs	30.99
5/8"	5200 lbs	3 lbs	49.99
3/4"	7000 lbs	4 lbs	69.99
7/8"	10000 lbs	6 lbs	209.99
1"	12500 lbs	10 lbs	254.99

### PEAR SHAPED LINKS



Size	Work Load	Ship	Net
3/8"	1800 lbs	1 lbs	\$14.99
1/2"	2900 lbs	1 lbs	19.99
5/8"	4200 lbs	1 lbs	29.99
3/4"	6000 lbs	2 lbs	44.99
7/8"	8300 lbs	3 lbs	62.99
1"	10800 lbs	5 lbs	89.99
1-1/4"	16750 lbs	9 lbs	144.99
1-3/8"	20500 lbs	11 lbs	239.99

### Suncor Universal Anchor Swivels

• 17-4 PH stainless steel, precision-cast  
• Stainless steel screw pins and swivel pins - 360°  
• Thread locking liquid included for cross pins  
• Bronze thrust washer • Multiple sizes fit 1/4" - 3/4" chain



Item	Model	Chain Size	Breaking Load	Ship	Net
003017	S0190-X008	1/4" - 5/16"	8500 lbs	2 lbs	\$91.99
	S0190-X013	3/8" - 1/2"	15000 lbs	4 lbs	116.99
	S0190-X020	1/2" - 3/4"	25000 lbs	14 lbs	317.99
003016	S0190-0008	1/4" - 5/16"	8500 lbs	2 lbs	69.99
	S0190-0013	3/8" - 1/2"	15000 lbs	3 lbs	81.99

### Lewmar Anchor Swivel

• 316 stainless steel screw pins • 316 stainless steel swivel pins - 360°  
• Attach between line and chain or between chain and anchor

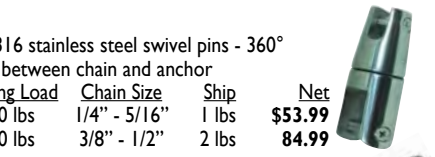

Item	Model	Working Load	Chain Size	Ship	Net
002742	SWIVEL312F	4500 lbs	1/4" - 5/16"	1 lbs	\$53.99
	SWIVEL500F	7000 lbs	3/8" - 1/2"	2 lbs	84.99

**Peerless Double-Ended Anchor Chain Rode Swivel**  
• Easy swiveling design • 1/4" - 5/16" • WLL: 1500 lbs  
• Stainless steel pin locks • Hot dip galvanized grade 40 high test steel  
Item 001401 440640011 Ship 2 lbs Net \$41.99

### Deck Pipe



Item	Model	Description	Ship	Net
001188	S-114	Chrome plated brass	2 lbs	\$59.99
		Inside Dia. Flange Max Rope Dia.		
		4" x 2-1/4"	6-1/8" x 4-3/8"	1"
001190	6008HC	316 stainless; hinged	3 lbs	\$75.99
		Inside Dia. Flange Max Rope Dia.		
		3-7/8" x 2-1/2"	4-1/8" x 2-7/8"	1-1/4"

### SEA-DOG STAINLESS STEEL HAWSE PIPE

Designed to protect the boats hull against damage from anchor line and chain while reducing rope chafe. Investment cast 316 stainless steel construction for corrosion resistance and durability. Installs with four FH fasteners (not included).

Item	Model	I.D.	O.D.	Ship	Net
001206	328160-I	1-1/2" x 3-11/16"	2-1/2" x 5-1/2"	1 lbs	\$21.99
001207	328170	2-7/8" x 6-7/8"	5-3/16" x 9-1/4"	3 lbs	59.99



**WHITECAP STAINLESS STEEL MOORING BIT / BOLLARD CLEAT**  
• Cleat Width: 7" • Base: 4.5" x 3.75" • Overall Height: 5"  
Item 011565 S-1320 Ship 5 lbs Net \$72.99  
Fastener Size: 5/16" (4 - Sold separately)

**SUNCOR CHAIN AND DECK PIPE**  
• Cover slides and is spring loaded to close automatically  
• Overall 5.5" L x 4.08" W • Opening 3.72" x 2.71"  
• 2" total height including below deck area  
Item 001726 S3810-0000 Ship 6 lbs Net \$64.99  
Uses (4) #10 fasteners (Not included)

**WHITECAP HINGED ROPE/CHAIN PIPE**  
• No chain needed • Flange: 3" • Triple-chromed brass  
• Inside dia: 1-1/2" • Max rope dia: 3/4" • Uses #10 screws (not included)  
Item 001194 S-112 Ship 1 lbs Net \$22.99

**WHITE WATER MARINE LARGE MOORING BIT**  
Material: 304 stainless steel tube, 304 stainless steel stamped  
Fastener: 1/2" FH, Dims: 8" Base x 4-1/2" W x 6-3/16" H  
Item 003316 7566S Ship 3 lbs Net \$99.99



## Mooring Pendants

### NOVABRAID CLIP & GO SMALL BOAT MOORING PENDANTS

- Ideal for light displacement powerboats up to 20' in protected waters
- Designed to be used with your boat's bow eye
- Stainless steel hardware • Double braid

Item	Size	SWL	Ship	Net
003441	1/2" x 6'	1200	2 lbs	\$74.99
	5/8" x 8'	2000	2 lbs	81.99

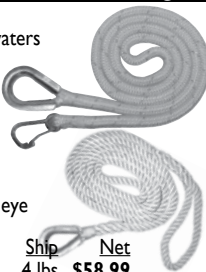

### NEW ENGLAND 3-STRAND MOORING PENDANT

- Material: 3-strand nylon with galvanized thimble, includes spliced eye
- High energy absorption • Adjustable chafe guard included

Item	Size	Eye	Ship	Net	Size	Eye	Ship	Net
003285	1/2" x 10'	12"	2 lbs	\$34.99	3/4" x 12'	15"	4 lbs	\$58.99
Please	1/2" x 15'	12"	2 lbs	40.99	3/4" x 15'	15"	5 lbs	65.99
Specify Size	5/8" x 12'	12"	3 lbs	47.99	3/4" x 20'	15"	5 lbs	72.99
	5/8" x 15'	12"	3 lbs	53.99	1" x 20'	24"	10 lbs	96.99

### NOVABRAID DOUBLE BRAID MOORING PENDANTS

- High tenacity polyester double braid with heavy duty galvanized thimble on one end and a soft eye splice at boat end with security tether
- Includes a 3 foot polyester chafe sleeve for extra protection
- Rope coated with Orange urethane finish to inhibit marine growth
- Includes nylon mesh winter storage bag



Item	Str./				Str./					
	Size	lbs	Eye	Ship	Net	Size	lbs	Eye	Ship	Net
002724	1/2" x 12'	10400	12"	2 lbs	\$62.99	1" x 15'	39200	18"	7 lbs	\$119.99
Please	5/8" x 12'	16100	12"	3 lbs	69.99	1" x 20'	39200	18"	7 lbs	124.99
Specify Size	5/8" x 15'	16100	12"	4 lbs	74.99	1" x 25'	39200	18"	9 lbs	131.99
	3/4" x 15'	21800	18"	5 lbs	89.99	1-1/4" x 20'	56500	18"	8 lbs	179.99
	3/4" x 20'	21800	18"	5 lbs	99.99	1-1/4" x 25'	56500	18"	10 lbs	199.99
	3/4" x 25'	21800	18"	7 lbs	112.99					

### NEW ENGLAND ROPES NYLON MOORING PENDANT

- Made from strong polyester/nylon combo double braid • Bright Yellow coating for improved abrasion resistance • Heavy-duty stainless thimble and a moveable chafe sleeve

Item	Size	Strength	Ship	Net
003295	1/2" x 12'	10400 lbs	3 lbs	\$89.99
Please	1/2" x 15'	10400 lbs	3 lbs	97.99
Specify Size	5/8" x 15'	15000 lbs	4 lbs	111.99
	5/8" x 20'	15000 lbs	4 lbs	116.99
	3/4" x 12'	20900 lbs	5 lbs	139.99
	3/4" x 15'	20900 lbs	5 lbs	142.99
	3/4" x 20'	20900 lbs	6 lbs	154.99
	3/4" x 25'	20900 lbs	7 lbs	157.99
	1" x 20'	35340 lbs	13 lbs	219.99



### NEW ENGLAND ROPES CYCLONE FLOATING MOORING PENDANT

- 100% Dyneema® fiber • Attach one or two cyclones to your mooring pendant for increased scope and storm protection • Urethane coated

Item	Size	Strength	Ship	Net
003365	1/2" x 6'	34300 lbs	2 lbs	\$134.99
	5/8" x 5'	58000 lbs	2 lbs	161.99
	5/8" x 8'	58000 lbs	2 lbs	184.99
	3/4" x 8'	69000 lbs	3 lbs	214.99



### YALE MAXI-MOOR II MOORING PENDANT

- Maxijacket™ urethane coating • Polyester/nylon construction
- Stainless steel thimble on one end and a soft eye on the other end with a tag line • Moveable chafe sleeve • Color code: Yellow (2 Green tracers)

Item 003416 Sizes from 1/2" x 12' to 1" x 26' • Prices range from \$119.99 to 239.99  
Please visit [www.defender.com](http://www.defender.com) for a complete list of sizes.  
\* Consult your harbor master for mooring recommendations.

## Mooring Balls/Buoys

### SOFTLITE HULL FRIENDLY MOORING BUOY

- Center tube diameter: 2-3/8" • Soft, tough and non-abrasive
- Not affected by sunlight, fuels or solvents

Item	Bottom Top Top				Ship	Net
	Dia.	O.D.	I.D.	Height		
002081/MAILORDER	18"	21-3/4"	15"	13-1/2"	12 lbs	\$209.99
002080/MAILORDER	24"	27"	20-1/2"	16"	22 lbs	259.99



### JIM BUOY PENDANT MOORING BUOY

- Keeps mooring pendant dry • White with Blue stripe
- High density polyethylene with lifting grips

Item	Model	Buoy Dia.	Tube Dia.	Buoyancy	Ship	Net
001768	4202-T	18"	2-1/2"	105 lbs	14 lbs	\$154.99
001769	4203-T	24"	3"	240 lbs	66 lbs	227.99
001770	4204-T	30"	3"	460 lbs	139 lbs	347.99



### JIM BUOY MOOR-PRO BUOY PROTECTOR COLLAR

- Rounded edges protect pendant line from fraying and shackle wear

Item	Model	Tube Dia.	Ship	Net
001773	4003	3"	1 lbs	\$11.99
001772	4002	2-1/2"	1 lbs	10.99
001771	4001	2"	1 lbs	9.99



### JIM BUOY DRUM MOORING BUOY

- Hard outer shell and 3 lbs high density polyurethane foam core
- Greater stability in water than standard ball mooring buoys
- 3" center hole for ring style mooring system

Item	Model	Buoy Dia.	Buoyancy	Ship	Net
006308	4304-T-W	30"	230 lbs	70 lbs	\$209.99



### TAYLOR MADE SUR-MOOR SHACKLE BUOY

- Built-in cup shape at the top of the buoy that allows the anchor shackle to nest below the buoy surface
- Buoyancy: 100 lbs

Item	Model	Buoy Dia.	Tube Dia.	Ship	Net
001266	46818	18"	2-1/2"	32 lbs	\$138.99



### TAYLOR MADE SUPER DELUXE PICK-UP BUOYS

- Lead weighted • Vinyl coated shaft
- Solid fitted float

Item	Model	Size	Ship	Net
001217	22105	48"	3 lbs	\$38.99
001218	22106	74"	3 lbs	43.99
001219	22126	96"	90 lbs	44.99



### TAYLOR MADE SUR-MOOR™ HARD SKIN BUOYS\*

- Tough, seamless one-piece polyethylene shell filled with foam
- Features ultraviolet light absorbers for long-term life
- Choose between hot-dipped galvanized eyebolt and swivel, or tube-through-the-center (Blue stripe is reflective)

#### SUR-MOOR T3™ MOORING BUOY

- Tube-through-the-center design

Item	Model	Buoy Dia.	Buoyancy	Tube Dia.	Ship	Net
011666	46370	12"	30 lbs	2"	6 lbs	\$85.99
011667	46371	15"	60 lbs	2"	8 lbs	106.99
011668	46372	18"	100 lbs	2-1/2"	32 lbs	136.99
990026	46374	24"	240 lbs	2-1/2"	81 lbs	215.99
011669	33020	Mooring collar for 2" tube			1 lbs	14.99
011670	33025	Mooring collar for 2-1/2" tube			1 lbs	18.99



### TAYLOR MADE TRADITIONAL SUR-MOOR MOORING BUOY

This buoy features a hot-dipped galvanized eyebolt and swivel.

Item	Model	Buoy Dia.	Buoyancy	Ship	Net
011671	22170	12"	30 lbs	7 lbs	\$102.99
011672	22171	15"	60 lbs	9 lbs	129.99
011673	22172	18"	100 lbs	32 lbs	159.99
011701	22174	24"	240 lbs	81 lbs	259.99



\*Manufacturer's three-year flotation warranty on all hard skin buoys.

### TAYLOR MADE REPLACEMENT CENTER ROD FOR TRADITIONAL MOORING BUOY

Item	Model	Buoy Dia.	Ship	Net	Item	Model	Buoy Dia.	Ship	Net
000594	33012	For 12"	3 lbs	\$45.99	000596	33018	For 18"	3 lbs	\$48.99
000595	33015	For 15"	3 lbs	47.99	755943	33024	For 24"	3 lbs	61.99

### POLYFORM INFLATABLE MOORING BUOYS

Features large 4-3/8" dia. galvanized and vinyl coated eye, 5/8" center tube for maximum strength and soft vinyl surface to protect your boat finish. **Specify:** White with Blue stripe or Fluorescent Red.

Item	Size	Buoyancy	Ship	Net
012212	13.5" x 18"	55 lbs	12 lbs	\$123.99
012213	17" x 22"	100 lbs	15 lbs	147.99



### JIM BUOY SMALL PICK-UP BUOY

Item	Description	Ship	Net
001216	Solid foam, galvanized thimble	1 lbs	\$21.99



## Winter Mooring Buoys

### TAYLOR MADE SULLY STICK™ WINTER STICK

A long tapered buoy used in place of a round mooring buoy during the winter months, the Sully Stick has a molded in eyelet at the top for easy retrieval. The base eyelet is reinforced with a galvanized metal bushing. The shape of the Sully Stick helps it escape ice entrapment better than a round buoy and can extend the useful life of a mooring buoy by protecting it from the damaging effects of freezing temperatures.

- Diameter: 6" (at widest point)

Item	Model	Size	Buoyancy	Ship	Net
012078	22140	80" long	40 lbs	21 lbs	\$79.99
000734	22120	31" long	15 lbs	4 lbs	58.99



### JIM BUOY WINTER SPAR BUOY

- Replaces mooring buoys during winter months
- Heavy duty polyethylene resists wear from ice and harsh conditions
- Tapered to remain free in icy conditions
- Hot-dipped galvanized bottom eye with 2" Blue retro-reflective top band
- Lifting eye for easy handling

Item	Model	Size	Weight	Ship	Net
006314	510-W	36"L, 6" dia. bottom, 4" dia. top single box 6.5" x 6.5" x 36.5"	17 lbs	8 lbs	\$66.99
006315	511-W	60"L, 6" dia. bottom, 4" dia. top single box 6.5" x 6.5" x 60"	30 lbs	19 lbs	79.99



## Mooring Anchors & Accessories

### MUSHROOM MOORING ANCHORS

- For permanent moorings
- Large eyes to accept the proper size shackle
- Heavy cast iron

Item	Size	Shackle	Chain	Ship	Net
003361	25 lbs	3/8"	3/8"	25 lbs	\$49.99
	50 lbs	7/16"	3/8"	50 lbs	66.99
	75 lbs	7/16"	3/8"	75 lbs	99.99
	100 lbs	1/2"	1/2"	100 lbs	132.99
	150 lbs	1/2"	5/8"	150 lbs	194.99
	200 lbs	5/8"	3/4"	200 lbs	259.99
	250 lbs	5/8"	3/4"	250 lbs	319.99
	300 lbs	3/4"	3/4"	300 lbs	379.99
	400 lbs	1"	3/4"	400 lbs	499.99
	500 lbs	1"	3/4"	500 lbs	589.99
	800 lbs	1"	3/4"	800 lbs	899.99

Local regulations for mooring anchors vary. Please contact your harbor master for mooring compliance.



**SAVE ON SHIPPING!**

Mooring anchors may also be picked up in our Waterford, CT warehouse.

PLEASE CALL FOR LARGER SIZES.

### PYRAMID MOORING ANCHORS

- One piece, cast iron, permanent mooring anchor for fresh or salt water
- Works well in a hard, rocky or sandy bottom

Item	Anchor Weight	Ship	Net
003362	25 lbs	25 lbs	\$47.99
	50 lbs	50 lbs	84.99
	100 lbs	100 lbs	144.99
	150 lbs	150 lbs	209.99
	200 lbs	200 lbs	279.99
	250 lbs	250 lbs	369.99
	300 lbs	300 lbs	399.99
	350 lbs	350 lbs	674.99
	400 lbs	400 lbs	549.99
	500 lbs	500 lbs	679.99



### GRAB 'N GO HOOK BY C.S. JOHNSON

- Made from hand polished investment cast type 316 Stainless Steel
- Comes complete with a slide and clamp for installation

Item	Model	Ship	Net
011808	48-750	1 lbs	\$84.99

### ROCNA VULCAN GALVANIZED ANCHOR

- For a snug fit on the bows of almost any boat
- For vessels from small runabouts to large yachts and powerboats
- Unique shank and fluke geometry combine with an innovative roll-palm™ to self-right the anchor on the seabed
- The V-bulb™ extends fluke ballast downward to gain maximum leverage and efficiency
- The anchor self-deploys from the majority of bow rollers
- High tensile steel and a unique I+V Profile™ shank design grants resistance to bending
- Lifetime warranty against defects, bending or deformation, see Rocna's website for details



Available in stainless steel as a special order.

Item	Boat size	Weight	Chain Size	Ship	Net
002990	13-23'	9 lbs	1/4"	9 lbs	\$170.99
	16-30'	13 lbs	1/4"	13 lbs	249.99
	20-36'	20 lbs	1/4"	20 lbs	299.99
	23-39'	27 lbs	5/16"	27 lbs	349.99
	26-46'	33 lbs	5/16"	33 lbs	399.99
	30-52'	44 lbs	5/16"	44 lbs	499.99
	33-59'	55 lbs	3/8"	55 lbs	699.99
	39-72'	73 lbs	3/8"	73 lbs	989.99
	46-79'	88 lbs	7/16"	88 lbs	1406.99
	52-85'	121 lbs	7/16"	121 lbs	1913.99

### ROCNA ORIGINAL GALVANIZED ANCHOR

- A Rocna always attains its correct setting attitude for quick penetration regardless of how it hits the bottom. It digs straight in, offers superior holding-power and will not easily trip out on load reversal.
- The instant set roll-bar ensures that it always lands at the ideal angle for penetration; it also reinforces the blade for massive strength
- Self-launching design makes for easy deployment
- Lifetime warranty against defects, bending or deformation

For more detailed sizing recommendations refer to [www.rocna.com](http://www.rocna.com)

Item	Boat Size	Weight	Chain	Ship	Net
002992	13-23'	9 lbs	1/4"	9 lbs	\$161.99
	16-30'	13 lbs	1/4"	13 lbs	230.99
	23-36'	22 lbs	1/4"	22 lbs	299.99
	26-46'	33 lbs	5/16"	33 lbs	368.99
	30-52'	44 lbs	5/16"	44 lbs	482.99
	33-59'	55 lbs	3/8"	55 lbs	644.99
	39-72'	73 lbs	3/8"	73 lbs	889.99

\*NOTE: For anchors 150 kg (330.7 lbs) and up, Rocna does not recommend chain size or anchor size for boat. It is suggested that anchor selection be based on RINA Rules, Part B, Chapter 10, Section 4, as appropriate for SHHP (Super High Holding Power) anchors.

### ROCNA FISHERMAN GALVANIZED ANCHOR

- Easy anchor retrieval in difficult conditions - Shackle rail allows you to retrieve the anchor from the opposite direction if it becomes fouled

Item	Boat size	Weight	Chain size	Ship	Net
002991	13-20'	9 lbs	1/4"	9 lbs	\$161.99

## LEWMAR®

LIFETIME GUARANTEE!

### LEWMAR DELTA® ANCHORS

**Self-Launch** - The Delta's shank is shaped to initiate self-launch from the stowed position. This means that when using a power windlass, the Delta can be released without assistance.

**Fast and Sure Setting** - On contact with the seabed, the Delta will immediately try to "right" itself due to extreme apex ballasting and geometric configuration of the anchor.

**Strong-Hold** - The Delta "blade" is designed to provide a totally balanced hold in the seabed, even on short scope, which is a real advantage in crowded anchorages. This ensures absolute stability with no tendency to break out under extreme load in a wide variety of seabed conditions. The one-piece construction is made from high grade Manganese steel. Trip line eye provides easy retrieval.

Lloyds approved high holding power anchor!

Item	Model	*Boat Size Sail	*Boat Size Power	Anchor Weight	Ship	Net
002995	0057404	20'-24'	18'-22'	9 lbs	9 lbs	\$87.99
	0057406	26'-31'	24'-30'	14 lbs	14 lbs	135.99
	0057410	34'-41'	32'-39'	22 lbs	22 lbs	191.99
	0057416	44'-52'	42'-50'	35 lbs	35 lbs	269.99
	0057420	49'-58'	47'-56'	44 lbs	44 lbs	355.99
	0057425	54'-64'	52'-62'	55 lbs	55 lbs	466.99
	0057432	59'-69'	57'-67'	70 lbs	70 lbs	613.99
	0057440	64'-75'	63'-75'	88 lbs	88 lbs	686.99

Lloyds approved ordinary holding power anchor!

### LEWMAR DTX SELF LAUNCHING DELTA STYLE ANCHOR

- Delta® style geometry - unique shank profile and ballasted tip for fast, accurate setting
- 316 stainless steel construction
- 3-Year warranty against breakage

Item	Model	*Boat Size Sail	*Boat Size Power	Anchor Weight	Ship	Net
002994	0057206	26'-31'	24'-30'	14 lbs	14 lbs	\$323.99
	0057210	34'-41'	32'-39'	22 lbs	22 lbs	541.99
	0057216	44'-52'	42'-50'	35 lbs	35 lbs	867.99
	0057220	49'-58'	47'-56'	44 lbs	44 lbs	1084.99

NEW!

### LEWMAR LFX ALLOY FLUKE ANCHOR "DANFORTH STYLE"

- Material: Aluminum Alloy; Disassembles for Storage

Item	Model	Boat Size	Anchor Wt.	Ship	Net
003439	0058102	Up to 27'	4 lbs	4 lbs	\$79.99
	0058103	26'-32'	7 lbs	7 lbs	134.99
	0058105	30'-38'	10 lbs	10 lbs	189.99
	0058107	35'-45'	15 lbs	15 lbs	284.99
	0058110	40'-51'	21 lbs	21 lbs	449.99

### LEWMAR WELDED COR ANCHOR

- Legendary status for its superior performance
- Original drop-forged construction
- Hinged shank delivers consistent setting and holding

Item	Model	*Approx. Boat Size	Anchor Weight	Ship	Net
003415	0056503W	14'-25'	15 lbs	15 lbs	\$199.99
	0056504W	20'-30'	20 lbs	20 lbs	229.99
	0056505W	30'-40'	25 lbs	25 lbs	339.99
	0056506W	35'-50'	35 lbs	35 lbs	379.99
	0056507W	50'-80'	45 lbs	45 lbs	449.99
	0056508W	52'-65'	60 lbs	60 lbs	539.99
	0056509W	60'-65'	75 lbs	75 lbs	579.99
	0056510W	60'-70'	105 lbs	105 lbs	969.99

### LEWMAR HORIZON CLAW ANCHOR

- One-piece high grade cast steel construction
- Unsurpassed strength and reliability at unbelievable savings

Item	Model	*Approx. Boat Size	Anchor Weight	Ship	Net
002996	0057905	15'-25'	11 lbs	11 lbs	\$41.99
	0057907	20'-30'	16.5 lbs	17 lbs	57.99
	0057910	25'-35'	22 lbs	22 lbs	73.99
	0057915	30'-40'	33 lbs	33 lbs	107.99
	0057920	35'-45'	44 lbs	44 lbs	137.99
	0057930	40'-55'	66 lbs	66 lbs	205.99
	0057950	50'-70'	110 lbs	110 lbs	392.99
	0057980	65'-85'	176 lbs	176 lbs	667.99

\* Larger anchors are recommended for boats with above average displacement.



## DANFORTH STANDARD

Traditional holding power associated with Danforth anchors. The shank is made of high strength steel. Each anchor has a hot-dipped, galvanized coating for long lasting protection.

Item **003001**  
Anchors from 3.5 - 100 lbs  
Prices from **\$27.99 - 424.99**

## DANFORTH HI-TENSILE®

Hi-Tensile is Danforth's toughest and most durable anchor. This anchor features very high holding power. The flukes are fabricated for additional strength and then beveled to allow quick and deep bottom penetration. Each shank is made from 4130 steel and then heat-treated for extra strength. These anchors have a hot-dipped, galvanized finish.

Item **003002**  
Anchors from 5 - 60 lbs  
Prices from **\$124.99 - 784.99**



## STAINLESS STEEL QUICKSET ANCHORS

- Marine grade USA stainless steel
- Specify finish (mirror, electro polished/satin, commercial/rugged)
- Specify size (14 lbs, 22 lbs, 35 lbs, 50 lbs)

Item	Finish	Starting At
<b>D 003359</b>	Mirror	<b>\$319.99</b>
<b>D 003360</b>	Polished	<b>394.99</b>
<b>D 003442</b>	Commercial	<b>234.99</b>

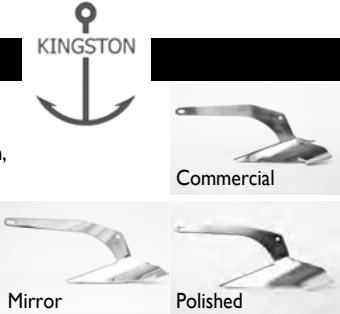

## Utility Anchors

### SEA-DOG FOLDING ANCHORS

Folding grapnel anchors are made with four arms that fold flat against the shank for compact storage. Constructed of hot dipped galvanized iron with forged flukes they are an inexpensive backup anchor on larger boats or great as a primary anchor on dinghies, PWC's, canoes, kayaks and small sailboats. Lockable in opened or closed position they are ideal for inflatable boats as there are no open flukes to puncture the sensitive fabric. Effective holding power in mud, sand, gravel or rocky conditions.

Item	Model	Boat Size	Anchor Weight	Ship	Net
Item <b>002907</b>	<b>318005</b>	5' - 14'	5.5 lbs	6 lbs	<b>\$20.99</b>
	<b>318007</b>	5' - 16'	7 lbs	7 lbs	<b>25.99</b>
	<b>318009</b>	5' - 18'	9 lbs	9 lbs	<b>35.99</b>
	<b>318013</b>	14' - 22'	13 lbs	13 lbs	<b>47.99</b>
	<b>318022</b>	22' - 30'	22 lbs	22 lbs	<b>69.99</b>
	<b>318033</b>	26' - 32'	33 lbs	33 lbs	<b>119.99</b>



## FORTRESS MARINE ANCHORS

Lightweight, high performance anchors with heavyweight holding power. Precision machined from specially hardened high-tensile-strength marine alloys to provide more strength than steel anchors. Can be disassembled. Adjustable fluke angles for various bottoms and mud palms supplied to enhance setting in all bottoms. Completely rust proof. Lifetime parts replacement warranty.



Item	Model	Boat Size	Anchor Weight	Ship	Net
Item <b>002998</b>	<b>FX-7</b>	16' - 27'	4 lbs	4 lbs	<b>\$109.99</b>
	<b>FX-11</b>	28' - 32'	7 lbs	7 lbs	<b>149.99</b>
	<b>FX-16</b>	33' - 38'	10 lbs	10 lbs	<b>214.99</b>
	<b>FX-23</b>	39' - 45'	15 lbs	15 lbs	<b>339.99</b>
	<b>FX-37</b>	46' - 51'	21 lbs	21 lbs	<b>499.99</b>
	<b>FX-55</b>	52' - 58'	32 lbs	32 lbs	<b>724.99</b>
	<b>FX-85</b>	59' - 68'	47 lbs	47 lbs	<b>1089.99</b>
	<b>FX-125</b>	69' - 150'	69 lbs	69 lbs	<b>1599.99</b>

## FORTRESS ANCHOR STOWAWAY BAGS FOR FX SERIES ANCHORS

Item **002474** Starting at **\$62.99**

## FORTRESS GUARDIAN UTILITY ANCHORS

Provides good, economical service for boaters with less demanding requirements. Made of aluminum magnesium alloy.

Item	Model	Boat Size	Anchor Weight	Ship	Net
Item <b>003003</b>	<b>G-5</b>	12' - 16'	2.5 lbs	3 lbs	<b>\$54.99</b>
	<b>G-7</b>	17' - 22'	4 lbs	4 lbs	<b>66.99</b>
	<b>G-11</b>	23' - 27'	6 lbs	6 lbs	<b>92.99</b>
	<b>G-16</b>	28' - 33'	7 lbs	7 lbs	<b>134.99</b>
	<b>G-23</b>	34' - 41'	13 lbs	13 lbs	<b>204.99</b>
	<b>G-37</b>	42' - 47'	18 lbs	18 lbs	<b>309.99</b>
	<b>G-55</b>	48' - 53'	29 lbs	29 lbs	<b>429.99</b>
	<b>G-85</b>	54' - 62'	42 lbs	42 lbs	<b>639.99</b>
	<b>G-125</b>	63' - 72'	65 lbs	65 lbs	<b>924.99</b>



## FORTRESS ANCHOR STOWAWAY BAGS FOR GUARDIAN ANCHOR MODELS

Item **002473** Starting at **\$64.99**

## Small Craft Anchors

### SEACHOICE MUSHROOM ANCHORS

Popular for fishermen, drift anchoring, inflatables and race buoys.

### White Painted Aluminum Double-dipped painted aluminum for rust resistance

Item	Model	Boat Size	Anchor Weight	Ship	Net
Item <b>003367</b>	<b>41280</b>	up to 10'	8 lbs	8 lbs	<b>\$17.99</b>
	<b>41300</b>	up to 12'	10 lbs	10 lbs	<b>22.99</b>
	<b>41340</b>	up to 16'	15 lbs	15 lbs	<b>27.99</b>

### Black Vinyl Heavy gauge Black vinyl for hull protection

Item	Model	Boat Size	Anchor Weight	Ship	Net
Item <b>003367</b>	<b>41200</b>	up to 10'	8 lbs	8 lbs	<b>\$18.99</b>
	<b>41220</b>	up to 12'	10 lbs	10 lbs	<b>22.99</b>
	<b>41260</b>	up to 16'	15 lbs	15 lbs	<b>29.99</b>

### ATTWOOD GRAPNEL ANCHOR SYSTEM

- 25 feet of rope
- Marker buoy
- Giant snap hook
- 3-1/2 lbs anchor
- Durable nylon storage case

Item	Model	Ship	Net
<b>000618</b>	<b>11969-4</b>	5 lbs	<b>\$39.99</b>

### DEFENDER'S INFLATABLE BOAT ANCHOR KITS

- Perfect for the small, open tender or a deluxe RIB
- Folding galvanized grapnel anchor and 100' of 3/8" line in a convenient heavy duty storage bag
- Will fit in most storage lockers or underseat bags

Item	Description	Ship	Net
<b>011964</b>	For boats up to 11' - 5.5 lbs anchor	10 lbs	<b>\$69.99</b>
<b>011965</b>	For boats 11-15' - 7 lbs anchor	12 lbs	<b>74.99</b>

### SEA-DOG FOLDING ANTI-SNAG ANCHOR KIT

Folding anti-snag grapnel anchor kit makes an ideal primary anchor on dinghies, small sailboats and inflatables. Cable tie break away from anchor chain for easy retrieval. Includes: 3 lbs. hot-dipped galvanized iron folding anchor with forged flukes, 3' of 3/16" vinyl coated anchor chain, 35' of 3/8" line, 10 cable ties, adjustable float, stainless fast eye boat snap and mesh storage bag. Compact and easy to store. Effective holding power in mud, sand, gravel or rocky conditions.

Item	Model	Ship	Net
<b>002901</b>	<b>318003KP</b>	6 lbs	<b>\$39.99</b>



### FORTRESS COMMANDO SMALL CRAFT ANCHOR SYSTEM

- Guardian G-5 anchor • 150' of 1/4" braided nylon rope
- 1/4" galvanized shackle • Anchor weight: 2.5 lbs
- 6' of 3/16" of high-tensile, galvanized steel chain
- Perfect for inflatables, bass boats, personal watercraft, runabouts, tenders, ski boats, etc.

Item	Model	Ship	Net
<b>001303</b>	<b>C5-A</b>	8 lbs	<b>\$129.99</b>

### INFLATABLE BOAT ANCHOR KITS

- Claw anchor with 4' of 3/16" chain
- Includes 100' of 3/8" line
- Storage bag

Item	Model	Dinghy Size	Anchor Weight	Ship	Net
Item <b>003341</b>	<b>KIT 3</b>	Up to 14'	2.5 lbs	9 lbs	<b>\$69.99</b>
	<b>KIT 4</b>	Up to 17'	4.4 lbs	9 lbs	<b>99.99</b>



## Anchor Rollers

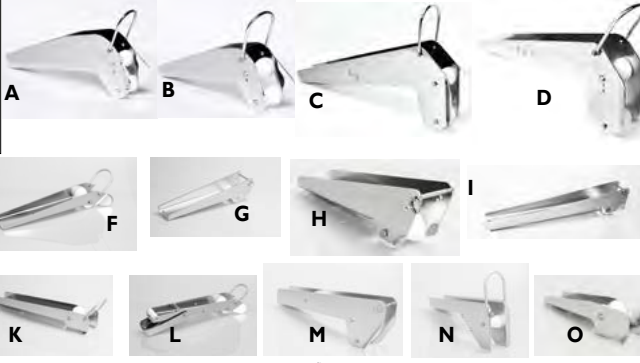

Item	Model	Size L* x Inside Channel	Ship	M.A.P.
A	012341	KR-2025	31-1/2" x 3"	11 lbs \$409.99
B	012340	KR-1015	27-1/8" x 3"	8 lbs 334.99
C	003444	KV-2025-P	33-7/8" x 3"	11 lbs 494.99
D	003443	KV-915-P	26" x 3"	8 lbs 394.99
E	000264	BR-22L EP	23-1/2" x 2-5/8"	7 lbs 184.99
F	003445	BR-20LL P	27-1/2" x 3"	9 lbs 154.99
G	000964	CQR-20 EP	19-11/32" x 3-1/2"	8 lbs 169.99
H	000263	BR-23 EP	22-3/4" x 2-5/8"	7 lbs 156.99
I	000965	CQR-30 EP	29-3/8" x 4"	14 lbs 259.99
J	000966	BR-22 EP	19-1/2" x 2-5/8"	8 lbs 172.99
K	012165	QR-20 EP	19-3/4" x 3"	6 lbs 139.99
L	012164	BR-21 EP	20-15/16" x 3-3/8"	8 lbs 199.99
M	012166	BRUCE-25 EP	24-3/8" x 2-1/2"	14 lbs 354.99
N	000967	DELTA-23	23-1/2" x 3-3/8"	18 lbs 409.99
O	002924	BR-11	11 x 2-5/8"	3 lbs 104.99

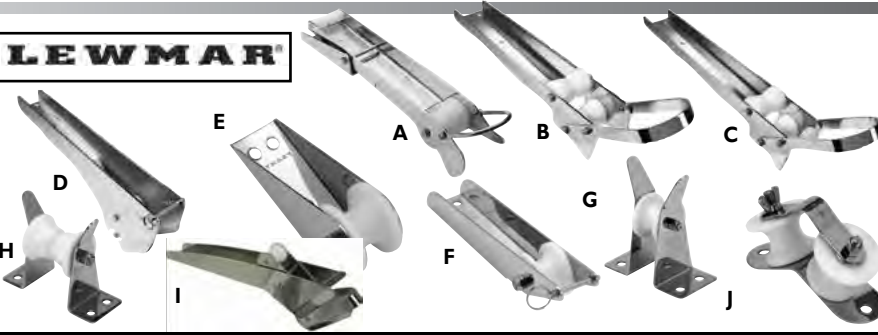

Item	Model	Size L* x Inside Channel	Ship	Net
A	000386	66840007	20" x 3"	8 lbs \$162.99
B	000387	66840008	19.5" x 2.625"	6 lbs 162.99
C	000388	66840009	23.5" x 2.625"	7 lbs 174.99
D	000389	66840017	24" x 2.5"	13 lbs 397.99
E	000375	66840060	6.25" x 1.75"	1 lbs 34.99
F	000376	66840061	11" x 1.8125"	2 lbs 85.99
G	000377	66840062	6" x 1.75"	2 lbs 50.99
H	000378	66840063	6" x 3.375"	3 lbs 78.99
I	012390	66840085	22.7" x 3.03"	9 lbs 274.99
J	000382	66840067	6.5" x 2.5"	2 lbs 49.99

\* Length does not include bail.

PLEASE VISIT WWW.DEFENDER.COM FOR RUBBER REPLACEMENT ROLLERS

### APPLICATION CHART

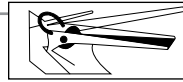

Holds anchor over the bow or stern

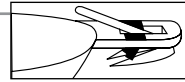

Holds anchor thru hole in bow plank or anchor roller

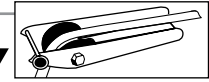

Pulley only. Does not hold anchor

Anchor Style / Weight	Kingston	Lewmar	Lewmar	Lewmar
<b>BRUCE® / CLAW ANCHORS</b>				
Small 2.2 - 16.5 lbs.	E, J, M, N, O	A, B, C	G, H	E, F, J
Medium 22 - 33 lbs.	E, J, M, N, O	A, B, C	H	E, F, J
Large 44 - 66 lbs.				F, J
<b>PIVOTING FLUKE-TYPE ANCHORS (DANFORTH®, ETC.)</b>				
Small 5 - 12 lbs.	E, F, I, J, L, N, O	A	G	E, F, J
Medium 13 - 28 lbs.	E, F, I, J, L, N, O	A	G, H	E, F, J
Large 22 - 60 lbs.	E, I, N		H	F, J
<b>CQR PLOW-TYPE ANCHORS</b>				
Small 25 - 35 lbs.	E, F, G, H, I, J, K, L, N, O	A, B, C, D	G, H	E, F, J
Medium 35 - 45 lbs.	E, G, H, I, J, K, N	C, D	G, H	E, F, J
Large 45 - 60 lbs.	G, H, I, N	D	G, H	F, J
<b>FORTRESS® ANCHORS AND LEWMAR LX</b>				
FX-7, FX-11, FX-16	E, F, I, J, L, N, O	A	G, H	E, J
FX-23	E, F, I, J, L, N, O	A	G, H	E, F, J
FX-37, FX-55	E, F, I, J, L, N, O	A	H	F
FX-85, FX-125	I		H (FX-85 Only)	E, F (85 only)
<b>DELTA® &amp; DTX ANCHORS</b>				
14 - 22 lbs.	E, F, G, H, I, J, K, L, N, O	A, B, C, D, I	G	E, F, J
35 lbs.	E, F, G, H, I, J, K, L, N, O	A, B, C, D, I		E, F, J
55 lbs.	E, G, H, I, N	D		F, J
<b>ROCNA &amp; MANSON SUPREME ANCHORS</b>				
22-33lb	B			
44-55lb	A			
<b>VULCAN &amp; MANSON BOSS ANCHORS</b>				
18-33lb	C			
44-55lb	D			

### Anchor Accessories

#### WINDLINE RAIL OR STANCHION MOUNT ANCHOR BRACKETS

- Fits all Fortress (without mud palms) and Danforth up to 35 lbs
- Fits 7/8" and 1" railings

Item	Model	Description	Ship	Net
000970	PM-1	Rail mount	1 lbs	\$47.99
000971	PM-2	Stanchion mount	1 lbs	47.99

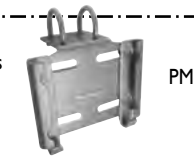

PM-1

#### WINDLINE ANCHOR TENSIONER

- Holds anchors up to 90 lbs safely and securely

Item	Model	Dimensions	Ship	Net
000972	AT-3	4.5" L x 2" W	1 lbs	\$65.99



AT-3

#### WINDLINE MARINE ANCHOR LOCK

- Stainless Steel channel lock
- Prevents accidental drop at sea
- Allows quick release of anchor
- Secures anchor
- For chain up to 7/16"
- For anchors up to 70 lbs

Item	Model	Length	Width	Ship	Net
000144	AL-1	4"	1.5"	1 lbs	\$35.99



#### WINDLINE CHAIN STOPPER

- Low-profile chain stopper prevents damage to windlass
- Easily mounts alone or with any bow roller
- 5000 lbs working strength
- Holds chain to 3/8"

Item	Model	L x H x W	Ship	Net
000974	CS-1	3.18" x 2.41" x 2.76"	2 lbs	\$94.99





## Anchor Accessories

### SHOCKLES™ ANCHOR SNUBBER™ - Stretches from 20" to 38"

- Eliminate shock loads in rough seas • Color: Black
- Strong 316 forged stainless steel captive shackles

Item	Breaking Strength	Ship	Net
001727	2000 lbs	1 lbs	\$49.99

### SHOCKLES™ LINESNUBBER™ - Stretches from 20" to 36"

- Eliminate dangerous shock loads on your boat
- (2) 316 Stainless steel carabiners offer secure attachment

Specify color: Blue (Model 2400) or Black (Model 2410)

Item	Breaking Strength	Ship	Net
001852	2500 lbs	2 lbs	\$49.99

### SHOCKLES LINEGRABBER - Sold (2) per package

- Designed to secure a line snubber or an anchor snubber
- Sewn, double loop of 1/4" (6 mm) ultra high modulus fiber

Item	Model	Breaking Strength	Ship	Net
001853	2460	2000 lbs	1 lbs	\$14.99

### SHOCKLES 12" DOCKSHOCKLE™ SNUBBER WITH MINI LINEGRABBERS

- For smaller, lighter boats up to 40 feet • Eases constant or sudden shock load

Item	Model	Inner Webbing Breaking Strength	Outer Sheath Breaking Strength	Ship	Net
002746	2415	2500 lbs	3500 lbs	1 lbs	\$39.99

### FALCON LINE-MASTER MOORING SNUBBERS

- Protects against wind, wave and wake
- Stretch to more than twice their length

Specify Line Size: 3/8", 5/8", 3/4" or 7/8-1" Item 003010 Prices Starting at \$26.99

### JOHNSON "CAPTAIN HOOK" CHAIN SNUBBERS

- 3-strand nylon with professional eye splice
- Secures chain to anchor roller while under way
- Hook/claw and attached line relieve tension from windlass while anchored

Item	Model	Fits Chain	Line Size	Ship	Net
000141	46-465	1/4" and 5/16"	12" of 1/2"	2 lbs	\$90.99
000465	46-475	3/8" and 1/2"	15" of 5/8"	3 lbs	145.99
001579	46-465-5	1/4" and 5/16"	Hook only	1 lbs	47.99

### C.S. JOHNSON SINGLE HOOK ANCHOR CHAIN TENSIONER

- Closed length: 12" • Adjustment: 1-1/2" • Material: Stainless steel

Item	Model	Fits Chain	Ship	Net
614085	46-250-1	5/16"	2 lbs	\$96.99

### WICHARD CHAIN GRIP HOOK

- For safer and quieter anchoring • Relieves tension on anchor chain

Item	Model	Chain Size	Ship	Net
003358	2984	1/4" (All Types) 5/16" G3 and G4	1 lbs	\$45.99
	2985	5/16" (All Types) 3/8" G3 and G4	1 lbs	52.99

### SCHAEFER 316 STAINLESS STEEL PULPIT MOUNTED ANCHOR HANGER

- 1" protective rail liner • Fits 1" tubing
- Fits Danforth-style anchors 8-22 lbs • Latch ensures secure fit
- Allows quick anchor release

Item 604460 Model AH-100 Ship 1 lbs Net \$58.99

### NUOVA RADE MOTORING CONE (DAY SHAPE)

- Required on sailboats 40'+(12 m) under power during daylight
- Display with cone pointing down • Molded Black plastic

Item	Model	Size (folded)	Ship	Net
002237	39552	18.5" x 13", folds flat	2 lbs	\$16.99

### NUOVA RADE ANCHORING BALL

- Internationally recognized signal indicates a vessel anchored during the day
- Molded Black plastic (Folds flat) • 11.8" diameter

Item 001181 Model 16185 Ship 2 lbs Net \$14.99

### ANCHOR TRIP LINE WITH MARKER BUOY

- Floating Orange marker with 100' of weather-resistant line
- Line has 800 lbs breaking strength

Item 001518 1204 Ship 2 lbs Net \$53.99

### ANCHOR RING ANCHOR RETRIEVAL SYSTEM

- Floats anchor tackle systems to 80 lbs • Use with any size buoy (A series Polyform work best - buoy sold separately)
- 5/16" Stainless steel ring

Item 001838 002.45 Ship 2 lbs Net \$26.99

❖ For more detailed product specifications and our complete selection visit [www.defender.com](http://www.defender.com) or call 800-628-8225. ❖

## Chafe Gear

### DAVIS INSTRUMENTS SECURE REMOVABLE CHAFE GUARDS

Install anywhere along lines from 3/8" to 1". Velcro® hook fasteners

grip the line securely; no need for additional ties. 16" long

Item 003021 Please specify Black or White Ship 1 lbs Net \$25.99/Pair

### TAYLOR MADE® PERIMETER® CHAFE GUARDS

- Fits through chocks
- Polyester textile with superior abrasion resistance
- Great for spliced eyes and temporary installations
- 18" regular includes 4 UV-resistant ties
- 16" removable includes ties and velcro fasteners



Item	Model	Description	For Line Sizes	Length	Ship	Net
003011	CG58.18	Chafe guard - pair	3/8" - 5/8"(pr.)	18"	1 lbs	\$16.99
	CG1.18	Chafe guard - pair	3/4" - 1"(pr.)	18"	1 lbs	18.99
003012	RCG58.14	Removable chafe guard - each	3/8" - 5/8"(ea.)	16"	1 lbs	16.99
	RCG1.14	Removable chafe guard - each	3/4" - 1"(ea.)	16"	1 lbs	19.99

### CAPE HATTERAS MOORING & DOCK LINE CHAFE GUARDS

- "ULTRA-V-TEK" tough fabric • Highly UV resistant
- Easy to install with Velcro

Specify Color: Navy, Black or Tan

Item	For Line Size	Length	Ship	Net/Pair
000252	3/8"-3/4"	14"	1 lbs	\$13.99

### SEA-DOG LEATHER CHAFE KITS - All ship at 1 lbs

- Includes: Waxed twine, heavy duty needle and (2) 10" pieces of leather pre-stamped for sewing. Used to reduce chafe and extend the life of mooring lines. Natural leather - color may vary.

Item	Line Size (pr)	Net	Item	Line Size (pr)	Net
001164	3/8" - 7/16"	\$8.99	001166	5/8"	\$9.49
001165	1/2"	8.99	002733	3/4"	10.99

### CHAFE-PRO HEAVY DUTY NYLON SLEEVE

- UV and mildew resistant chafe protection for dock, anchor and mooring lines
- Proprietary ballistics nylon weave • Sold by linear foot

Item	Line size	Color	Ship	Net
003399	1/2" - 5/8"	Black	1 lbs	\$3.99
	3/4"	Black	1 lbs	4.99
	1"	Black	1 lbs	5.99

### CHAFE-PRO

- Made in the USA • Removable
- Fastens to rope with hook and loops • Sold in pairs • Color: Black • All ship 1 lbs.

Item	Description	Length	Fits line	Net/Pr
001886	Yacht grade series, nylon, hook-and-loop closure	14"	3/8"-3/4" M.A.P.	\$27.00
001887	Yacht grade series, nylon, hook-and-loop closure	16"	3/8"-1"	32.99
001888	Chafe-Pro barracuda, added outer layer polyester over the inner layer of heavy-grade nylon	18"	3/4"-1-1/2"	56.99

### CHAFE-PRO WOOLY CHAFE GUARDS - PAIR

- Sheepskin texture prevents dock lines from scuffing gelcoat finish
- Fits line sizes from 3/8" to 5/8" • Specify Color: Black or White

Item	Length	Ship	Net/pr	Length	Ship	Net/pr
002688	18"	1 lbs	\$117.99	30"	1 lbs	\$191.99

### SPIROLL CHAFE GUARDS

- UV resistant polyurethane stands up to chafe and abrasion
- Highly flexible and self-wraps around line for a snug, trim fit

Item	For Line Size	Length	Ship	Net
003371	3/4"-1"	23-1/2"	1 lbs	\$13.99/ea.
	5/16"-5/8"	15-3/4"	1 lbs	13.99/pr.

Specify Black or Orange

## Splicing & Whipping Products

### SELMA SPLICING FID SET

- (5) fids • Highly polished stainless steel • Lines 1/8" - 1-1/2"

Item 605735 Model CSE5097SPL Ship 1 lbs Net \$61.99

### SEA-DOG HOLLOW FID Stainless steel fids with hardwood handle.

Item	Model	Size	Ship	Net
001240	562008-1	1/8" - 1/2"	1 lbs	\$5.49
001241	562016-1	1/2" and over	1 lbs	8.99

### RONSTAN D-SPLICER FID KIT

- Includes: Handle, anchoring loop, (2) 1 mm and (2) 1.5 mm needles

Item	Model	Size	Ship	M.A.P.
615402	SPLICE-6	5/16" to 5/32"	1 lbs	\$55.95

Individual fids from Ronstan Available at [www.Defender.com](http://www.Defender.com)

### NEW ENGLAND ROPE SPLICING KIT

- Kit includes (2) size fids and complete instructions.

Item	Model	Description	Ship	Net
000361	9100-00-00000	1/4" to 1"	1 lbs	\$28.99

### NEW ENGLAND ROPE TOW STYLE FID KIT

- Includes (5) fids sized 6mm - 12mm. Solid machined aluminum

Item 003385 Model C9200-00-00000 Ship 1 lbs Net \$84.99

### RONSTAN SPLICING SCISSORS

- Will cut Kevlar® fabric, new style hi-tech lines and more
- Blade material: High carbon alloy steel • Total length: 8"

Item 615404 Model RFSCISSORS Ship 1 lbs M.A.P. \$55.95

### ELECTRIC ROPE CUTTING GUN

- Simultaneously cuts and seals the ends of synthetic ropes • Power: 120 VAC at 60 cycle, Amps: 1.1, Watts: 100 • Includes (1) blade

Item	Description	Ship	Net	Item	Description	Ship	Net
752502	Gun w/5" cord	2 lbs	\$39.99	752503	Extra blade	1 lbs	\$9.99

### MDR WHIP-END DIP

- Brush applicator for any type of rope • Permanent, tough and flexible

Specify Color: Clear, Red or White Item 756678 Ship 1 lbs Net \$6.99

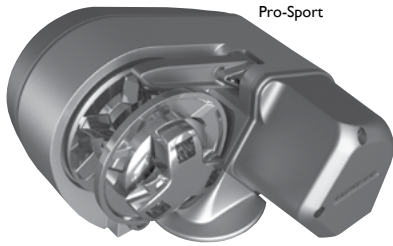

Pro-Sport

### Pro-Sport Composite 550 Windlass

- Powerful motor provides superior line speed
- Dual-direction powered operation
- Convenient above-deck installation
- Low power consumption / current draw
- Manual freefall
- Aluminum center case with composite sides

3 Year Warranty!

Item	Model	Style	Boat Length	Line Dia. & Type	Chain Dia. & Type	Typical/Max Line Speed	Power Supply	Watts	Draw	Max Pull	SWL	Ship	Net
000337	Pro-Sport Composite 550	H	20-28'	1/2" 3-strand or 8-plait	1/4" G4 or BBB, 6 mm Din 766	62'/min typical 98'/min max	12 VDC	150	20A	550	137.5	19 lbs	\$499.00



Pro-Series

### Pro-Series Stainless Steel Windlass

- 100% 316 Stainless Steel housing
- Easy to install
- Max line speed 105 ft. per minute
- Both include guarded rocker switch, dual direction solenoid and circuit breaker
- Efficient and reliable

5 Year Warranty!

Item	Model	Style	Boat Length	Line Dia. & Type	Chain Dia. & Type	Typical/Max Line Speed	Power Supply	Watts	Draw	Max Pull	SWL	Ship	Net
001748	Pro-Series 700 Kit	H	20-32'	1/2" 3-strand or 8-plait	1/4" G4 or BBB, 6mm Din 766	88'/min typical 105'/min max	12 VDC	500	35A	700	175	29 lbs	\$709.99
011998	Pro-Series 1000H	H	30-38'	9-16-5/8" 3-strand or 5/8" 8-plait	5/16" G4	88'/min typical 105'/min max	12 VDC	700	50A	1000	250	31 lbs	849.99
000291	66000616	Pro-Series Conversion Kit - Converts existing Pro-Series 700 and 1000 windlasses to a freefall windlass* * Check serial # of Pro-Series to ensure compatibility. Only serial # 561*** or 571*** can add the conversion kit.										4 lbs	211.99



Pro-Fish

### Pro-Fish Freefall Windlass

- Includes all the features of the Pro-Series, plus automatic freefall
- 316 Stainless Steel freefall mechanism
- Freefall operation can be disengaged to power down
- Both 700 and 1000 models include guarded rocker switch, dual direction solenoid and circuit breaker

5 Year Warranty!

Item	Model	Style	Boat Length	Line Dia. & Type	Chain Dia. & Type	Typical/Max Line Speed	Power Supply	Watts	Draw	Max Pull	SWL	Ship	Net
001749	Pro-Fish 700	H	20-32'	1/2" 3-strand or 8-plait	1/4" G4 or BBB, 6 mm Din 766	88'/min typical 105'/min max	12 VDC	500	35A	700	175	31 lbs	\$799.99
012100	Pro-Fish 1000	H	30-38'	9-16-5/8" 3-strand or 5/8" 8-plait	5/16" G4	88'/min typical 105'/min max	12 VDC	700	50A	1000	250	33 lbs	899.99



H-Series Gypsy Only

### H Series Windlass

- Quick, easy, one-piece installation
- 700W/1000W motors
- Robust horizontal worm motor-gearbox for reliable performance
- Includes built-in dual direction contactor, breaker and rocker switch

3 Year Warranty!

#### GYPSY ONLY

Item	Model	Style	Boat Length*	Line Dia. & Type	Chain Dia. & Type	Typical/Max Line Speed	Power Supply	Watts	Draw	Max Pull	SWL	Ship	Net
011904	H2 700, 8 mm gypsy	H	35-45'	9/16-5/8" 3-Strand or 5/8" 8-Plait	5/16" G4 ISO, 5/16" BBB	56'/min typical 69' min max	12 VDC	700	80A	1433	358	52 lbs	\$1799.00
011905	H2 700, 10 mm gypsy	H	35-45'	9/16-5/8" 3-Strand or 5/8" 8-Plait	3/8" BBB	56'/min typical 69' min max	12 VDC	700	80A	1433	358	53 lbs	1799.00
011906	H3 1000, 8 mm gypsy	H	40-48'	9/16-5/8" 3-Strand or 5/8" 8-Plait	5/16" G4 ISO, 5/16" BBB	59'/min typical 92' min max	12 VDC	1000	85A	1962	475	55 lbs	1849.00
011907	H3 1000, 10mm gypsy	H	40-48'	9/16-5/8" 3-Strand or 5/8" 8-Plait	3/8" BBB	59'/min typical 92' min max	12 VDC	1000	85A	1962	475	56 lbs	1849.00

#### GYPSY/DRUM



H-Series Gypsy / Drum

Item	Model	Style	Boat Length*	Line Dia. & Type	Chain Dia. & Type	Typical/Max Line Speed	Power Supply	Watts	Draw	Max Pull	SWL	Ship	Net
011908	H2 700, 8mm Gypsy	H	35-45'	9/16-5/8" 3-Strand or 5/8" 8-Plait	5/16" G4 ISO or BBB	56'/min typical 69' min max	12 VDC	700	80A	1433	358	57 lbs	\$1829.00
011909	H2 700, 10 mm Gypsy	H	35-45'	9/16-5/8" 3-Strand or 5/8" 8-Plait	3/8" BBB	56'/min typical 69' min max	12 VDC	700	80A	1433	358	57 lbs	1829.00
011910	H3 1000, 8 mm Gypsy	H	40-48'	9/16-5/8" 3-Strand or 5/8" 8-Plait	5/16" G4 ISO or BBB	59'/min typical 92' min max	12 VDC	1000	85A	1962	475	59 lbs	1899.00
011911	H3 1000, 10 mm Gypsy	H	40-48'	9/16-5/8" 3-Strand or 5/8" 8-Plait	3/8" BBB	59'/min typical 92' min max	12 VDC	1000	85A	1962	475	60 lbs	1899.00

#### MANUAL EMERGENCY RECOVERY SYSTEMS

Item	002461	Model	66840045	For	H series	Ship	7 lbs	Net	\$368.99
------	--------	-------	----------	-----	----------	------	-------	-----	----------



### HX1 Horizontal Windlass

Lewmar is launching a new range of stylish, strong and reliable horizontal windlasses using the latest inline motors and epicyclic gearboxes. It has a strong and durable anodized aluminum chassis, designed to withstand years of use. The covers are available in a choice of materials: polymer or anodized aluminum.

- 2 gypsy options to choose from 6/7 mm 1/4", and 8 mm 5/16"
- The HX1 is available in gypsy only, gypsy drum and the generation 2 Pro-Fish mechanism

Item	Model	Description	Ship	Net
003374	69140031	HX1 windlass with Gypsy only 1/4" G4	23 lbs	\$777.99
69140033	69140033	HX1 windlass with Gypsy only 5/16" G4	23 lbs	777.99
003375	69140035	HX Ser windlass with capstan 1/4" G4	26 lbs	878.99
69140037	69140037	HX Ser windlass with capstan 5/16" G4	26 lbs	878.99

PLEASE VISIT WWW.DEFENDER.COM FOR DETAILS

VISIT WWW.DEFENDER.COM FOR ADDITIONAL INFORMATION & WINDLASS PACKAGE DEALS!



## V700 Vertical Windlass Kit

• 100% 316 stainless steel housing and a sleek flush-mount design • Kit includes: Contactor/solenoid and circuit breaker • Fall-safe anchor lock

Item	Model	Boat Length	Line Dia. & Type	Chain Dia. & Type	Typical/Max Line Speed	Power Supply	Watts	Draw	Max Pull	SWL	Ship	Net
001750	V700 Kit 6670011108-312	to 35'	1/2" 3-strand or 8-plait	1/4" G4 or BBB, 6mm din 766	50/82/min	12 VDC	320	45A	700	175	20 lbs	\$626.99



V700G

## VX1 Vertical Windlass Kits

An entry-level windlass giving the end user a stylish yet functional product at a competitive price point. Consists of a cast aluminum core with a composite and stainless steel exterior. • Manual clutch release • Drum option • Same footprint as Lewmar V1 model • Hybrid polymer gypsy-15% reduction in weight, 5% stronger and quieter than any other comparable gypsy on the market • IP 67 gear box

Item	Model	Boat Length	Line Dia. & Type	Chain Dia. & Type	Typical/Max Line Speed	Power Supply	Watts	Draw	Max Pull	SWL	Ship	Net
003293	VX1 GO	to 32'	1/2" 3-strand or 8-plait	1/4" HT (6 mm)	82'/min	12V	300	66 A	882	220	24 lbs	\$666.99
	VX1 GO	to 40'	5/8" 3-strand or 8-plait	5/16" HT (8 mm)	82'/min	12V	500	126 A	1488	373	24 lbs	682.99
003294	VX1 GD	to 40'	1/2 inch 3 strand or 8-plait	1/4" HT (6 mm)	82'/min	12V	500	126 A	1488	373	25 lbs	757.99
	VX1 GD	to 40'	5/8" 3-strand or 8-plait	5/16" HT (8 mm)	82'/min	12V	500	126 A	1488	373	25 lbs	757.99



VX GD

VX GO

## V Series Vertical Windlass - V1, V2 and V3 MODELS

• FastFit makes installation quick and easy and ensures proper drive shaft alignment • Compact stainless steel windlass for power and sailboats  
 • Deck unit conceals the drive train, worm gearbox and splined shaft • Includes windlass, rocker switch, breaker, two-direction solenoid and handle  
 • Rope-chain or all-chain anchor rodes may be deployed at the touch of a button

Item	Model	Boat Length	Line Dia. & Type	Chain Dia. & Type	Typical/Max Line Speed	Power Supply	Watts	Draw	Max Pull	SWL	Ship	Net
000148	V1, 5/16" Gypsy 6671011108-138	to 42'	5/8" 3-strand or 8-plait	5/16" G4	46/65/min	12 VDC	700	80A	1000	250	44 lbs	\$1161.99
002264	V2 Gypsy Only	20-45'	5/8" 3 strand or 8 plait	5/16" G4 or 3/8" G4	46/69/min	12 VDC	700	80A	1433	358	47 lbs	1799.99
002265	V2 Gypsy/Drum	20-45'	5/8" 3 strand or 8 plait	5/16" G4 or 3/8" G4	46/69/min	12 VDC	700	80A	1433	358	53 lbs	1829.99
012384	V3 Gypsy Only 6672211110-139	40-50'	5/8" 3 strand or 8 plait	3/8" G4	59/92/min	12 VDC	1000	85A	1962	473	54 lbs	2297.99
012385	V3 Gypsy/Drum 6672221110-139	40-50'	5/8" 3 strand or 8 plait	3/8" G4	59/92/min	12 VDC	1000	85A	1962	473	60 lbs	2377.99
000621	V4 Gypsy 66910080-143	50-70'	5/8" 3-strand or 3/4" 8-plait	3/8" G4	49/82/min	12 VDC	1600	125A	2750	668	70 lbs	3229.99
000622	V4 Gypsy/Drum 66910088-143	50-70'	5/8" 3-strand or 3/4" 8-plait	3/8" G4	49/82/min	12 VDC	1600	125A	2750	668	78 lbs	3401.99



V Series Gypsy



V Series Gypsy/Drum

## MANUAL EMERGENCY RECOVERY SYSTEMS

Item 000503	Model 66840056	For V1, V2, V3GD series	Ship 3 lbs	Net \$277.99
-------------	----------------	-------------------------	------------	--------------

## Lewmar Windlass Accessories

### 3-BUTTON WINDLASS WIRELESS REMOTE CONTROL KIT

• Easily retrofitted to existing installations; includes a replaceable battery  
 • Allows wireless remote operation (up/down) of any solenoid switched windlass  
 • Fobs float and are waterproof



Item 001658 Model 68000967 Ship 1 lbs Net \$287.99

### REMOTE ANTENNA KIT

• Improves range of wireless windlass/thruster kits  
 • 32.8' (10 m) long

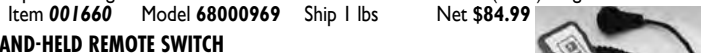

Item 001660 Model 68000969 Ship 1 lbs Net \$84.99

### HAND-HELD REMOTE SWITCH

• Controls windlass in both directions  
 • Includes waterproof plug and waterproof deck-mount socket



Item 002736 Model 68000599 Ship 1 lbs Net \$134.99

### DECK MOUNTED FOOT SWITCH FOR WINDLASS

• 12/24 VDC  
 • Single direction switch  
 • Hinged cover prevents accidental operation • One switch per package



Please Specify Finish and Direction (Up or Down)

Item	Finish	Ship	Net
002776	Black or White	1 lbs	\$37.99
002801	Stainless steel	1 lbs	84.99
012104	Black or White (pair)	1 lbs	74.99

### 5X WINDLASS FOOT SWITCH

• Polished stainless steel cover  
 • Power supply: 12 / 24 VDC, Max  
 • Cutout: 28 mm



Please Specify Open or Closed Lid

Item 002050 Ship 1 lbs Net \$137.99

### STAINLESS STEEL CHAIN STOPPERS

When the windlass is not in use and the boat is at anchor, the chain should be secured using a chain stopper.



Item	Model	Chain Size	Ship	Net
011953	66840079	3/8"	4 lbs	\$162.99
000340	66840080	1/2"	8 lbs	332.99
000384	66840069	1/4"-3/8"	2 lbs	50.99

### STAINLESS STEEL ANCHOR LOCK

• Fits chain or shackle to 3/8" diameter  
 • Locks chain or shackle in place using quick release 1/4" captive pin



Item	Model	Boat Size	Ship	Net
000385	66840070	20'-45'	1 lbs	\$31.99

### ANCHOR CHAIN TENSIONER

• Pulls anchor chain tight and keeps it snug against its roller  
 • Requires (2) #12 fasteners • Stainless steel • 1-3/8" W x 7" L



### AA150 RODE/CHAIN COUNTER

• Includes console unit, sensor and magnet  
 • 12/24 VDC, Current Consumption: 30 mA  
 • Monitors all-chain or rope/chain anchor rode length from helm



Item 615730 Model 66830014 Ship 1 lbs Net \$383.99

### AUTOANCHOR AA560 ANCHOR RODE COUNTER

• Deploys and retrieves a preset length of anchor rode  
 • Power supply: 12/24 VDC; Draw: 4 A  
 • Works with rope/chain or all-chain rode



Item 602381 Model 66830015 Ship 2 lbs Net \$569.99

### REPLACEMENT COMPOUND GEAR ASSEMBLY V700

• For V700 and Sprint 400, 500, 600 windlasses



Item 000633 Ship 1 lbs Net \$94.99

### GEN 2 WINDLASS GEARS AND SHAFT KIT

• For second generation Pro-Series/Fish windlass with serial numbers starting 561, 563, 565 and 571



Item 002784 Ship 4 lbs Net \$233.99

### REPLACEMENT COMPOUND GEAR ASSEMBLY

Item 608918 For ProSeries 1st gen Ship 1 lbs Net \$99.99  
 For ProSeries 2nd gen 1 lbs 99.99  
 For ProSeries 3rd gen 1 lbs 129.99

### LEWMAR WINDLASS REPLACEMENT MOTORS

Item	Model	Description	Ship	Net
012423	66200146	Replacement motor for Pro-Sport	5 lbs	\$134.99
000597	66000610	Replacement motor for V700 and Sprint 600	6 lbs	141.99
003422	66000107	Replacement motor for 700 and 1000 Pro-Series	6 lbs	152.99
001837	68000527	Replacement motor gearbox for Lewmar V2 and Concept 1 windlasses	22 lbs	872.99

VISIT WWW.DEFENDER.COM FOR OUR SELECTION OF SPARE AND REPLACEMENT PARTS

# MAXWELL



www.maxwellmarine.com



STAINLESS STEEL

RC6 with "fast install," in-line vertical gear box and motor



STAINLESS STEEL

RC8



STAINLESS STEEL

RC10-10

## RC Series Stainless Steel Windlasses

These low profile and capstan windlasses feature the patented Maxwell Wave Design™ chainwheel and stainless steel housings. This newly designed chainwheel offers far superior holding power with less wear on the rope. Designed for easy installation, the RC8 and RC10 motors can be oriented in any of 10 different positions. The huge through-deck hawse pipe ensures easy entry and exit of the rope/chain or all chain rode. All models include dual direction solenoid, breaker panel up/down panel, and handle.

**Style:** Vertical **Rode type:** Rope/chain **Draw:** 80 A-120 A **Power supply:** 12 VDC  
**Chain Wheel/Housing:** Stainless steel **Warranty:** 3 year

Item	Model	Max Pull	Speed Up (Min)	Motor (Watts)	Rope Size*	Recommended Chain Size**	Ship	M.A.P.
001490	RC-6 12V	770 lbs	69 ft/min	500 W	1/2"	1/4" HT Short link	22 lbs	\$901.13
001491	RC8-6CAP12V	770 lbs	79 ft/min	600 W	1/2"	1/4" HT Short link	40 lbs	1332.38
001492	RC8-8 12V	1320 lbs	92 ft/min	1000 W	5/8"	5/16" HT Short link	43 lbs	1544.44
012220	RC10-8 12V	1540 lbs	65 ft/min	1000 W	5/8"	5/16" HT Short link	51 lbs	2116.50
012222	RC108CAP12V100TDC	1540 lbs	65 ft/min	1000 W	5/8"	5/16" HT Short link	55 lbs	2273.25
012221	RC10-10 12V	1870 lbs	65 ft/min	1200 W	5/8"	3/8" HT Short link	52 lbs	2179.13
012223	RC1010CAP	1870 lbs	65 ft/min	1200 W	5/8"	3/8" HT Short link	56 lbs	2336.06



RC10-10 with Capstan

## HRCFF-6 & HRCFF-8 Kits

The compact HRCFF-6 and HRCFF-8 are Maxwell's horizontal versions of their latest and innovative new vertical RC 6 and RC 8 automatic rope/chain windlasses. These sleek units incorporate Maxwell's automatic free fall technology. They feature the patented Maxwell Wave Design chainwheel. This newly designed chainwheel offers far superior holding power with less wear on the rope. Trouble-free rode transition is guaranteed by means of an innovative, proven and patented pressure arm system within a safe, enclosed design.

**Style:** Horizontal **Rode type:** Rope/chain **Draw:** 50A **Housing:** Anodized aluminum  
**Chain Wheel:** Stainless steel **Warranty:** 3 year



HRCFF-6

Item	Model	Max Pull	Recommended Chain Size**	Rope Size* (Nylon)	Power Supply	Motor (Watts)	Circuit Breaker	Ship	M.A.P.
001741	HRCFF612V	900 lbs	1/4" HT short link	1/2"	12 VDC	600 W	50A	29 lbs	\$1067.25
001742	HRCFF812V	900 lbs	5/16" HT short link	9/16"	12 VDC	600 W	70A	29 lbs	1067.25

HRC-10



## HRC 10-8 & HRC 10-10

The HRC 10-8 and HRC 10-10 are Maxwell's newest fully automatic rope/chain or all chain horizontal windlasses. The HRC 10's are packed with highly original, proven features, including Maxwell's patented Wave Design chainwheel. This newly designed chainwheel offers far superior holding power with less wear on the rope. The aesthetically pleasing, entirely above-deck design encapsulates the motor and drive in a two-part, water-tight case. The two-part case consists of a die cast, marine grade, hard anodized alloy front section and a rugged, easily removable composite motor cover. This allows for quick and easy on-deck routine maintenance. 24V available via special order.

**Style:** Horizontal **Rode type:** Rope/chain **Draw:** 80 A-120 A  
**Housing:** Anodized aluminum **Chain Wheel:** Stainless steel **Warranty:** 3 year limited

Item	Model	Max Pull	Recommended Chain Size**	Rope Size* (Nylon)	Power Supply	Motor (Watts)	Ship	M.A.P.
001743	HRC10812V	1540 lbs	5/16" HT short link	9/16" - 5/8"	12 VDC	1000 W	45 lbs	\$2351.63
001744	HRC101012V	1870 lbs	3/8" HT short link	5/8"	12 VDC	1200 W	55 lbs	2586.94

## RC12 Series

- Includes top works, motor/gear box and dual direction solenoid
- Rope/chain wheel design ensures maximum grip on rope splice
- Wave Design chainwheel
- Balance force pressure arm system eliminates snags
- Simple-to-activate emergency/manual crank mechanism

**Chain Wheel/Housing:** Stainless steel

Item	Model	Max Pull	Recommended Chain Size**	Rope Size* (Nylon)	Speed Up (Min)	Power Supply	Motor (Watts)	Ship	M.A.P.
012361	RC1210	2500 lbs	3/8" HT short link	3/4"	65 ft/min	12 V or 24 VDC (specify)	1200 W	84 lbs	\$3292.69
012363	RC1210CAP	2500 lbs	3/8" HT short link	3/4"	65 ft/min	12 V or 24 VDC (specify)	1200 W	87 lbs	3465.94
012365	RC1212	3500 lbs	1/2" HT short link	3/4"	43 ft/min	12 V or 24 VDC (specify)	1200 W	84 lbs	3684.75
012367	RC1212CAP	3500 lbs	1/2" HT short link	3/4"	43 ft/min	12 V or 24 VDC (specify)	1200 W	90 lbs	3858.00

\* 3-Strand or 8-Plait is recommended

\*\* The Maxwell Wave Design chain wheels used across the RC series meets DIN 766, EN818, ISO4565, Grade L (AUS), ISO (G30 G43) and limited NACM standards.



RC12

Important: Maxwell windlasses must be used in conjunction with a chain stopper and/or alternative snubbing device to take the load off the windlass while laying at anchor. The chain stopper and alternative snubbing system should also be used to secure the anchor in the fully raised position while underway.





www.maxwellmarine.com

# MAXWELL

## VWC Kits VERTICAL WINDLASS & CAPSTAN 24 VDC MODELS AVAILABLE BY SPECIAL ORDER

- Includes dual direction solenoid, two footswitches, up/down panel switch, on/off breaker panel, chain pipe and handle
- Fully automatic, single or dual direction chainwheel operation
- High quality finish on above-deck components – heavy chrome over marine grade alloy bronze
- Integral chain pipe and stripper are aligned for virtually jam-free operation providing automatic feed of chain to and from the anchor locker
- Port and starboard chain pipes for twin installations (Sizes 2500 and above only)

Item	Model	Max Pull	Chain Sizes (Short Link)	Line Speed (Normal Working)	Power Supply	Motor (Watts)	Ship	M.A.P.
001673	VWC1000	1540 lbs	1/4" - 3/8"	60 ft/min	12 VDC	1000	57 lbs	\$2661.56
001674	VWC1500	1870 lbs	1/4" - 3/8"	60 ft/min	12 VDC	1200	57 lbs	2881.13
012371	VWC2500	2500 lbs	5/16" - 7/16"	50 ft/min	12 VDC	1200	91 lbs	4261.13
001676	VWC3500	3500 lbs	3/8" - 1/2"	50 ft/min	12 VDC	1200	107 lbs	4919.81



Please Specify Chain Type and Size

VWC

## VW VERTICAL WINDLASS & CAPSTAN 24 VDC MODELS AVAILABLE BY SPECIAL ORDER

- Includes circuit breaker, one footswitch and handle

Item	Model	Max Pull	Chain Sizes (Short Link)	Line Speed (Normal Working)	Power Supply	Motor (Watts)	Ship	Net
000207	VW1000	1540 lbs	1/4" - 3/8"	59 ft/min	12 VDC	1000	52 lbs	\$1784.99
000208	VW1500	1870 lbs	1/4" - 3/8"	59 ft/min	12 VDC	1200	53 lbs	1964.99
012372	VW2500	2500 lbs	5/16" - 3/8"	50 ft/min	12 VDC	1200	100 lbs	3244.99
000210	VW3500	3500 lbs	3/8" - 1/2"	50 ft/min	12 VDC	1200	105 lbs	4034.99

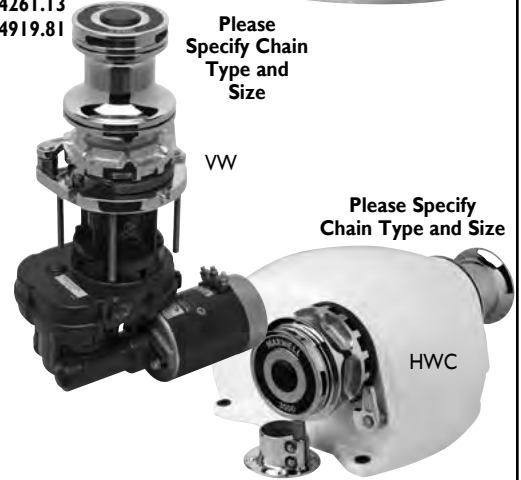

Please Specify Chain Type and Size

VW

Please Specify Chain Type and Size

HWC

## HWC Kits HORIZONTAL WINDLASS & CAPSTAN 24 VDC MODELS AVAILABLE BY SPECIAL ORDER

- Includes dual direction solenoid, two footswitches, up/down panel switch, on/off breaker panel, handle, chain pipe assembly

Item	Model	Max Pull	Chain Sizes (Short Link)	Line Speed (Normal Working)	Power Supply	Motor (Watts)	Ship	Net
001678	HWC2500	2500 lbs	5/16" - 3/8"	50 ft/min	12 VDC	1200	118 lbs	\$4264.99
001679	HWC3500	3500 lbs	3/8" - 1/2"	50 ft/min	12 VDC	1200	120 lbs	4394.99

\* NOTE: Maxwell VW, VWC, and HWC windlasses available in 24 VDC or hydraulic by Special Order.

## Accessories



### MAXWELL COMPACT WIRELESS REMOTE WINDLASS CONTROLLER

This radio controller may be used for remote operation of ALL Maxwell anchor windlasses. Complete with receiver, wiring and multi-plugs, it is suitable for direct connection to all windlasses. Additional wiring for operation of Maxwell hydraulic windlasses is available as an extra. Item 001747 Model P102991 Ship 1 lbs Net \$199.99

To Special Order, please contact Defender with the specific Maxwell part number.

### MAXWELL AA710 HANDHELD WIRELESS REMOTE

Includes all the features of the AA560 plus options to control a bow thruster or deck lights and anchor wash.

- Handheld controller displays rode count, signal strength and battery level
- Shockproof and water resistant to IP67
- Rubber over molding for grip and non-slip protection

Item	Model	Description	Ship	Net
001781	AA710	For all-chain or rope/chain rode windlasses	3 lbs	\$864.99

Note: Two base stations can be combined and controlled by one remote to allow control of two windlasses, plus other ancillary equipment. Kit includes (1) handheld remote control and (1) base station, (1) sensor and (1) magnet.



### MAXWELL AA150RC RODE COUNTER

- Large LCD display shows at a glance the length of rode deployed
- 2" diameter standard marine instrument gauge
- Adjustable Red backlighting for clear night viewing
- Choice of feet or meters rode measurement
- Beeps to warn the skipper that the anchor is within 4' of docking

Item	Model	Description	Ship	Net
012224	P102939	For all-chain or rope/chain rode windlasses	1 lbs	\$399.99



### MAXWELL AA560 PANEL MOUNT WINDLASS CONTROLLER AND RODE COUNTER

- Preset stopping point and docking alarm on retrieval
- One-touch function to deploy and retrieve a preset length of rode
- Adjustable backlit display in feet, meters or fathoms
- Graphic LCD screen featuring intuitive user interface
- Displays windlass speed and direction, plus battery voltage
- Safety lock to help protect against accidental windlass deployment
- Logs windlass operation hours to help ensure regular windlass maintenance
- Weather cover

Please Specify Black or Gray Console.

Item	Description	Ship	Net
012352	For all-chain or rope/chain rode windlasses	1 lbs	\$574.99



### FOOTSWITCHES

Maxwell heavy-duty, weather resistant units have a UV stabilized water proof diaphragm and are supplied complete with mounting instructions and screws.

- Rated at 5 amps maximum current and suitable for 12 VDC or 24 VDC applications
- Nickel-plated copper contacts ensure corrosion-free, reliable operation

Specify Color: Black or White

Item	Ship	Net
001740	1 lbs	\$36.99



### MAXWELL WINDLASS HEAVY DUTY FOOT SWITCH - WHITE OR BLACK PLASTIC

- Power supply: 12 / 24 VDC, Max. current draw: 150 Amp
- UV-stabilized waterproof diaphragm

Item	Description	Ship	Net
010000	Specify Black (P19006) or White (P19007)	1 lbs	52.99

### MAXWELL WINDLASS HEAVY DUTY FOOT SWITCH - STAINLESS STEEL

- Power supply: 12 / 24 VDC, Max. current draw: 150 Amp
- UV-Stabilized waterproof diaphragm

Item	Model	Ship	Net
012374	P100735	1 lbs	\$99.99



### MAXWELL ANCHOR SWIVELS

The use of a swivel to join anchor and rode will improve anchor retrieval and ensure that the rode lies neatly in the anchor locker.

Item	Model	Size	Ship	Net
002936	P104370	1/4" - 5/16"	1 lbs	\$41.99
002936	P104371	3/8" - 7/16"	2 lbs	52.99

### ADDITIONAL ACCESSORIES

Item	Model	Description	Ship	Net
012217	P100019	Freedom pressure assembly	1 lbs	\$23.99
012218	P100084	Freedom 500 stripper arm kit	1 lbs	23.99
012219	P100085	Freedom 800 stripper arm kit	1 lbs	23.99
012216	P102837	HRC pressure arm kit	1 lbs	24.99
001016	P100791	135 Amp breaker panel	1 lbs	109.99
001017	P100790	80 Amp breaker panel	1 lbs	109.99
012441	SP5104	Dual direction/Reversing solenoid, 12 VDC for series wound windlass motors	2 lbs	154.99
012440	SP5102	Dual direction/Reversing solenoid for permanent magnet windlass motors, 12 VDC	2 lbs	154.99

For more detailed product specifications and our complete selection visit [www.defender.com](http://www.defender.com) or call 800-628-8225.

For more information on Lofrans windlasses, please contact Imtra at 508-995-7000 or visit [www.imtra.com](http://www.imtra.com)

## Project Series Vertical Windlasses

- Polished chrome bronze construction
- Stainless steel stripper
- Fast, reliable retrieval of rope/chain rodes
- Retrieval speed is 52 - 72' / min
- Includes watertight control box, two covered footswitches, operator's handle and stainless steel fasteners
- Optional versions offer extra clearance (up to 5") for thick decks

Item	Model	Style	Boat Length	Line Dia.	Chain Dia. and Type	Power Supply	Watts	Draw (Amps)	Max Pull	SWL	Ship	M.A.P.
012014	Project 500	V/Low Profile	20-32'	1/2"	1/4" HT	12 VDC	500	30-60	970	320 lbs	25 lbs	\$1353.00
011961	Project 1000	V/Low Profile	23-46'	9/16", 5/8"	5/16" HT 5/16" BBB	12 VDC*	1000	70-120	1500	500 lbs	52 lbs	2009.00
011981	Project 1000	V/Capstan	23-46'	9/16", 5/8"	5/16" HT 5/16" BBB	12 VDC*	1000	70-120	1500	500 lbs	56 lbs	2132.00
012307	Project 1500	V/Low Profile	39-59'	9/16", 5/8" or 3/4"	5/16" HT, 5/16" BBB or 3/8" HT	12 VDC or 24 VDC	1500/1700	80-130	1850/2450	620/820 lbs	61 lbs	Starting at 3075.00
012308	Project 1500	V/Capstan	39-59'	9/16", 5/8" or 3/4"	5/16" HT, 5/16" BBB or 3/8" HT	12 VDC or 24 VDC	1500/1700	80-130	1850/2450	620/820 lbs	65 lbs	Starting at 3157.00

\* 24 Volt DC available as a special order.

## Cayman, Tigres and Falcon Horizontal Windlasses

- Durable, anodized housing
- Includes chain gypsy and rope drum
- Fast, reliable retrieval
- Each windlass includes (1) watertight control box, (2) covered footswitches and operator's handle
- Tigres and Falcon models feature snubber line horn cleat
- Specify chain size/type
- Falcon models have brake band and remote hawse pipe assembly
- Tigres and Falcon are available in 24 Volt DC by special order

Item	Model	Style	Boat Length	Chain Dia. and Type	Retrieval Speed	Power Supply	Watts	Draw (Amps)	Max Pull	SWL	Ship	M.A.P.
001075	Cayman	H	26-46'	1/4HT, 5/16ALL, 3/8BALL	65'/min	12 VDC*	1000	70-120	1900	625 lbs	58 lbs	\$2296.00
012304	Tigres	H	36-49'	1/4HT, 5/16HT and BBB, 3/8 BBB and 3/8 HT/PC	80'/min	12 VDC*	1500	80-130	2300	765 lbs	61 lbs	2542.00
012107	Falcon	H	45-65'	3/8 HT, 3BBB, 7/16HT, 1/2HT, 1/2BBB	60'/min	12 VDC*	1700	90-135	2600	850 lbs	110 lbs	4879.00
012108	Falcon	H Dual Gypsy	45-65'	3/8BBB, 3/8HT, 7/16HT, 1/2HT, 1/2BBB	60'/min	12 VDC*	1700	90-135	2600	850 lbs	110 lbs	5945.00

\* 24 Volt DC available as a special order.

## Royal Manual Horizontal Windlass

- Simple to install and easy to operate
- 1.2:1 Gear ratio; 440 lbs power rating
- Specify chain gypsy (1/4", 5/16" or 3/8")
- Includes operating handle
- Available in anodized finish



Royal

Item	Model	Style	Boat Length	Chain Dia. and Type	Retrieval Speed	Max Pull	SWL	Ship	M.A.P.
011916	Royal	H/Manual	26-39'	1/4HT, 5/16ALL, 3/8ALL	Manual	440	440 lbs	28 lbs	\$1066.00

## AutoAnchor Windlass Control/Counter

- The ultimate in windlass control systems
- Deploy or retrieve your anchor with the touch of a button
- High-visibility LCD screen displays the amount of rode out for rope/chain or all-chain rodes
- Easy to program and easy to use



Please specify: Gray or Black

Item	Model	Description	Ship	Net
000396	SPA-AA560	Control/counter kit	2 lbs	\$574.99
Specify: 6.5 M, 10 M, 15 M, 20 M or 25 M				
002662	SPA-AA9502	Sensor cable	2 lbs	\$54.99

## Windlass Switchgear and Accessories

Imtra offers a wide range of accessories to complement Lofrans, Muir or any other windlass manufacturer. Choose remotes, breakers and hand held remotes to customize your installation. Deck switches and watertight control boxes are available for replacements or for use with other windlasses.

### FOOTSWITCHES

- High-amperage switches
- Operate a windlass with or without a control box
- Max load: 200 A continuous, 600 A "make and break"
- Includes stainless steel fasteners



Item	Model	Description	Ship	Net
001086	SPA-10500K	4" deck switch, chrome	1 lbs	\$72.99
001087	SPA-10502K	4" deck switch, covered, Black	1 lbs	49.99
012039	SPA-10504K	4" deck switch, covered, White	1 lbs	49.99

### BREAKER PANELS

Available in 50, 70, 110 and 150 Amp sizes. Thru-bulkhead models include a faceplate and install with a simple 2-1/8" diameter cutout. All are IP66 rated for use in wet locations. Connections are 5/16" to accept large terminal lugs. All accept input voltage up to 48 Volt DC. Measures 3-1/4" x 4-1/2".

Please specify Amp size : 50, 70, 110 or 150

Item	Ship	Net
000397	1 lbs	\$142.99



### TOGGLE UP/DOWN REMOTE

Simple, dash-mount momentary Up/Down remote panel. 2" x 3-1/2".

Item	Model	Description	Ship	Net
001090	SPA-10550	Panel remote Up/Down switch	1 lbs	\$34.99



### WATERTIGHT CONTROL BOXES

Rugged control boxes with two integral solenoids for Up/Down windlass control. Heavy-duty 8 mm connections for sure power transfer. Includes fasteners.

Item	Model	Description	Ship	Net
011963	SPA-10700	3 Wire	3 lbs	\$134.99
012023	SPA-10697	2/4 Wire	3 lbs	134.99



### WATERPROOF HANDHELD REMOTES

Control your windlass with this handy remote. 7' coiled cable and watertight deck plug (with cover) included. Also available with clever LED flashlight for nighttime use.

Item	Model	Description	Ship	Net
012109	HRC1002	Up/Down remote w/o light	3 lbs	\$129.99
012110	HRC1002L	Up/Down remote with light	3 lbs	194.99





### Stainless Steel Cleats

**SUNCOR BLUE WATER CLEATS** Precision cast 316 stainless steel.

Item	Model	Fasteners	Length	Ship	Net
003430	S3138-0000	1/4"	8"	2 lbs	\$37.99
	S3140-0000	5/16"	10"	3 lbs	55.99
	S3142-0000	5/16"	12"	5 lbs	107.99
	S3145-0000	3/8"	15"	7 lbs	177.99



**SUNCOR HERRESHOFF CLEAT** Precision cast 316 stainless steel.

Item	Model	Fasteners	Length	Ship	Net
003431	S3106-0000	1/4"	6"	1 lbs	\$16.99
	S3108-0000	1/4"	8"	1 lbs	21.99
	S3110-0000	5/16"	10"	2 lbs	36.99
	S3112-0000	5/16"	12"	3 lbs	54.99



**SUNCOR TRIMLINE CLEAT** Precision cast 316 stainless steel.

Item	Model	Fasteners	Length	Ship	Net
003015	S3204-0000	3/16"	4"	1 lbs	\$11.99
	S3206-0000	1/4"	6"	1 lbs	19.99
	S3208-0000	1/4"	8"	2 lbs	29.99



**SUNCOR FLAGPOLE CLEAT** Precision cast 316 stainless steel.

Item	Model	Fasteners	Length	Ship	Net
651070	S3103-0000	#8	2-1/2"	1 lbs	\$2.99
	S3104-0000	#10	4-1/2"	1 lbs	3.99



**WHITECAP STAINLESS STEEL HOLLOW BASE CLEAT**

Item	Model	Fastener	Length	Ship	Net
003432	6009	1/4"	6"	1 lbs	\$16.99
	6010	1/4"	8"	1 lbs	21.99
	6011	5/16"	10"	2 lbs	37.99
	6012	5/16"	12"	2 lbs	53.99
	6110	1/4"	8", heavy duty	2 lbs	51.99
	6111	5/16"	10", heavy duty	3 lbs	71.99



**SCHAEFER 316 STAINLESS STEEL OPEN BASE CLEATS**

- Smooth radius edges reduce line chafe
- Counter sunk holes for flush fastening – urethane washers included

Item	Model	Max Line		Fastener	Ctr. to		Ship	Net
		Size	Size		Ctr.	Ctr.		
003433	60-75	3"	1/4"	#8 FH	3/4"	1 lbs	\$29.99	
	60-120	4-3/4"	3/8"	#10 FH	1-1/4"	1 lbs	38.99	
	60-150	6"	1/2"	1/4" FH	1-1/2"	1 lbs	47.99	
	60-200	8"	5/8"	5/16" FH	2"	2 lbs	70.99	
	60-250	10"	3/4"	3/8" FH	2-1/2"	3 lbs	100.99	



### Line Chocks / Chock and Cleat

**SUNCOR CHOCKS**

Sold in sets: (1) Port and (1) Starboard. Precision cast 316 stainless steel.

**SUNCOR SKENE CHOCKS**

Item	Model	Fasteners	Length	Ship	Net
003426	S3340-0000	#10	4.5"	1 lbs	\$25.99
	S3360-0000	1/4"	6"	2 lbs	42.99
	S3390-0000	5/16"	9"	7 lbs	132.99



**SUNCOR STRAIGHT CHOCKS**

Item	Model	Length	Rope Dia.	Ship	Net
003427	S3405-0000	5"	3/4" max	1 lbs	\$40.99
	S3406-0000	6"	1" max	2 lbs	49.99



**SUNCOR BOW CHOCKS**

Item	Model	Fasteners	Length	Ship	Net
003428	S3304-0000	#10	4"	1 lbs	\$16.99
	S3306-0000	1/4"	6"	2 lbs	20.99



**SCHAEFER STAINLESS STEEL BOW CHOCKS**

- "Fasten from the Top" model - generous radius edges keep chafe to a minimum • Narrow jaw keeps lines in place • Deep opening to accept chafe gear and a thick base to keep lines off of your deck • Material: Electropolished 316 stainless steel finish

Item	Model	Length	Max line size	Ship	Net
003292	60-41	5-5/8"	5/8"	1 lbs	\$50.99
	60-51	7-1/2"	3/4"	2 lbs	83.99
	60-61	9-1/4"	1"	4 lbs	146.99



**SCHAEFER STAINLESS XCL BOW CHOCKS**

- Smooth, generous radius edges reduce line chafe
- Recessed for bedding to provide watertight seal
- Deep opening accepts mooring lines with chafe gear
- Hidden metric fasteners and backing plate included
- Narrow jaw opening design – keeps mooring lines securely in place

Item	Model	Length	Max line size	Stud size	Stud Ctr. - Ctr.	Ship	Net
003429	60-40	4"	5/8"	M(10mm)	2-7/8"	1 lbs	\$59.99
	60-50	5-1/4"	3/4"	M(12mm)	3-3/4"	3 lbs	97.99
	60-60	6-3/4"	1"	M(14mm)	5"	5 lbs	162.99



**SCHAEFER MIDSHIP CHOCK AND CLEAT**

Investment cast 316 marine grade stainless steel rail cleat. Quick, adjustable stainless steel spring pin means no need for tools. Mount a chock or cleat where you want it.

Item	Model	Length	Size	Ship	Net
614226	70-74	6-1/2"	1" x 1/8" track	1 lbs	\$94.99
612955	70-75	7-1/2"	1-1/4" x 3/16" track	2 lbs	106.99



### Polished Brass Cleats & Chocks

**WHITECAP POLISHED BRASS HOLLOW BASE DECK CLEAT**

Item	Model	Length	Height	Ship	Net
002910	S-970B	5-1/2"	1-3/16"	1 lbs	\$17.99
	S-971B	6-1/2"	1-1/4"	1 lbs	26.99
	S-972B	8"	1-11/16"	1 lbs	30.99
	S-973B	10"	2-1/8"	2 lbs	61.99



**WHITECAP POLISHED BRASS SKENE BOW CHOCKS**

Item	Model	Length	Max Line	Ship	Net/Pair
002911	S-980B	4"	1/2"	1 lbs	\$21.99
	S-981B	4-1/2"	5/8"	1 lbs	30.99
	S-982B	5-1/2"	3/4"	2 lbs	46.99



### Aluminum Cleats

**SCHAEFER SELF JAMMING ALUMINUM CLEAT**

Item	Model	Length	Finish	Line	Ship	Net
612942	70-78	4"	Black	5/16"	1 lbs	\$42.99
612944	70-79	5"	Black	3/8"	1 lbs	48.99
612945	70-80	6"	Black	1/2"	1 lbs	59.99
612946	60-78	4"	Silver	5/16"	1 lbs	42.99
612947	60-79	5"	Silver	3/8"	1 lbs	48.99
612948	60-80	6"	Silver	1/2"	1 lbs	59.99



**SCHAEFER 4-HOLE ALUMINUM DECK CLEAT**

Item	Model	Length	Finish	Line	Ship	Net
612949	70-06	6"	Black	7/16"	1 lbs	\$41.99
612950	70-08	8"	Black	3/4"	1 lbs	52.99
612951	70-10	10"	Black	7/8"	1 lbs	83.99
612952	60-06	6"	Silver	7/16"	1 lbs	41.99
612953	60-08	8"	Silver	3/4"	1 lbs	52.99
612954	60-10	10"	Silver	7/8"	1 lbs	83.99



**SCHAEFER OPEN BASE ALUMINUM CLEAT**

Item	Model	Length	Finish	Line	Ship	Net
003435	70-94	4"	Black	3/8"	1 lbs	\$25.99
	70-95	5"	Black	1/2"	1 lbs	29.99
	70-96	6"	Black	5/8"	1 lbs	36.99
	70-98	8"	Black	5/8"	1 lbs	48.99
	60-94	4"	Silver	3/8"	1 lbs	22.99
	60-95	5"	Silver	1/2"	1 lbs	30.99
	60-96	6"	Silver	5/8"	1 lbs	33.99
	60-98	8"	Silver	5/8"	1 lbs	44.99



**SEA-DOG DOCK CLEAT**

Open base dock cleat. Die cast aluminum. Fasteners sold separately.

Item	Model	Fastener	Size	Ship	Net
000415	046108	1/4" FH	8"	1 lbs	\$6.79
000416	046110	5/16" FH	10"	1 lbs	8.99



### Galvanized Iron Cleats

**SEA-DOG HEAVY DUTY GALVANIZED IRON DOCK CLEATS**

Fasteners sold separately.

Item	Model	Length	Fastener	Ship	Net
000441	040908	8"	1/2" FH	3 lbs	\$11.99
000442	040910	10"	1/2" FH	6 lbs	18.99
000443	040812	12"	5/8" HH	11 lbs	29.99



**SEA-DOG LIGHT DUTY GALVANIZED IRON CLEATS**

(For flat head fasteners.) Fasteners sold separately.

Item	Model	Length	Fastener	Ship	Net
000445	040108	8"	5/16" FH	2 lbs	\$4.99
000446	040110	10"	3/8" FH	3 lbs	7.49
000447	040112	12"	3/8" FH	4 lbs	12.99
000448	040114	14"	1/2" FH	6 lbs	19.99



### Folding Cleats

**C.S. JOHNSON TOE RAIL FOLDING CLEAT**

T-316 stainless steel movable mid-ship cleat for spring lines, etc. Mountable on most aluminum toe rails. Rail is protected by a silicon rubber pad for rattle-free installation. Folds out of the way when not in use.

Item	Model	Diameter	Ship	Net
613756	48-510	3/8"	2 lbs	\$72.99



### Rod Holder Cleats

**TACO MARINE PORTABLE ROD HOLDER CLEATS**

Aluminum with brushed finish, multi-purpose cleat that inserts into a rod holder. Max. line size 3/4". Fits 1-5/8" diameter rod holder.

Item	Model	Description	Ship	Net
003328	F30-0861BSA	14-1/2" cleat, 15° angle rod holder	3 lbs	\$67.99
003329	F30-0862BSA	28" locking transom cross tie cleat	4 lbs	106.99

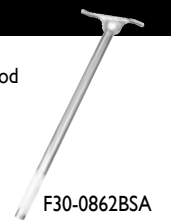

## Polyform Fenders & Accessories



Polyform's high quality fenders and buoys are popular hull protection at a great price. Most Polyform fenders and buoys are covered by Polyform's lifetime limited warranty for the original purchaser, which covers replacement of a product deemed defective due to workmanship or materials. Please visit <https://www.polyformus.com/t-warranty.aspx> for more details.

### Polyform Ribbed Twin Eye Fender

Polyform's most affordable fender. Durably constructed with molded-in ribs to increase overall strength and abrasion resistance.

Colors: White, Blue, Black, Forest Green, Navy, Catalina Blue or Red (G-1 Only).

Item	Model	Size (inches)	Boat Size	Ship	Net
000846	G-1	3.5 x 12.8	Up to 10'	1 lbs	\$11.99
000848	G-2	4.5 x 15.5	10' - 20'	2 lbs	13.99
000850	G-3	5.5 x 19	10' - 20'	2 lbs	14.99
000852	G-4	6.5 x 22	20' - 30'	3 lbs	24.99
000854	G-5	8.8 x 26.8	20' - 30'	5 lbs	43.99
000856	G-6	11 x 30	30' - 40'	7 lbs	59.99

### Polyform Commercial Grade Classic European Twin Eye Fender

The strongest fender Polyform manufactures. For permanent, unprotected moorings, pilings, locks and concrete walls. Reinforced rope hole at each end in a dark color to hide soiling. For heavy-duty, recreational and commercial use. Polyform's best looking and largest selling fender. Colors: White or Blue.

Item	Model	Size (inches)	Boat Size	Ship	Net
012117	F-1	6 x 24	20' - 30'	3 lbs	\$39.99
012118	F-2	8.2 x 25	20' - 30'	5 lbs	51.99
012119	F-3	8.2 x 30	20' - 30'	6 lbs	68.99
012120	F-4	8.5 x 40.5	30' - 40'	8 lbs	85.99
012121	F-5	11 x 30	30' - 40'	8 lbs	96.99
012122	F-6	11 x 42	30' - 40'	11 lbs	126.99
012123	F-7	15 x 41	50' - 60'	11 lbs	179.99
012124	F-8	15 x 58	60' - 70'	20 lbs	279.99
012125	F-10	18 x 50	60' - 70'	20 lbs	299.99
012126	F-11	21.2 x 57.5	60' - 70'	26 lbs	367.99
012127	F-13	29 x 76.5	70' - Up	62 lbs	769.99

### Polyform Low Drag Buoys

Low drag - reduces drag by as much as 80% compared to the drag of the A buoy. For reliability in the most extreme conditions. Colors: White, Yellow or Red.

Item	Model	Size (inches)	Boat Size	Buoyancy	Ship	Net
012128	LD-2	11.5 x 24	30' - 40'	68 lbs	6 lbs	\$53.99
000859	LD-3	13.5 x 29	40' - 50'	121 lbs	8 lbs	74.99

### Polyform Line-Through Fender

Polyform's versatile line-through fender has a 5/8" center tube for line, allowing vertical or horizontal use. Designed for medium-duty use.

Colors: White, Blue, Black, Forest Green, Catalina Blue or Navy.

Item	Model	Size (inches)	Boat Size	Ship	Net
012113	HTM-1	6.3 x 15.5	20' - 30'	3 lbs	\$36.99
012114	HTM-2	8.5 x 20.5	25' - 30'	5 lbs	51.99
012115	HTM-3	10.5 x 27	30' - 40'	8 lbs	83.99
012116	HTM-4	13.5 x 34.8	40' - 50'	31 lbs	117.99

### Polyform NF Fenders

The NF fender provides a value priced fender for the boater who is looking for the best protection for the dollar spent. You get sleek, one color styling, ribbed sides and a reinforced multiple-ribbed rope hole. An extra-tough, recreational boating fender. Colors: White or Blue.

Item	Model	Size (inches)	Eye Dia. (inches)	Boat Size	Ship	Net
011992	NF-3	5.6 x 19	5/8	10' - 20'	3 lbs	\$19.99
011993	NF-4	6.4 x 21.6	3/4	20' - 30'	4 lbs	33.99
011994	NF-5	8.9 x 26.8	3/4	20' - 30'	6 lbs	54.99

### Polyform Commercial Grade Buoys/Fenders

Used widely in commercial fishing and offshore oil industries, Polyform's heavy duty buoys are the only one-piece buoys on the market with a reinforced rope hole eye. Suitable for use as fenders or buoys. Colors: White or Red.

Item	Model	Size (inches)	Boat Size	Buoyancy (lbs.)	Ship	Net
012129	A-0	8 x 11.5	Up to 20'	13	2 lbs	\$27.99
012130	A-1	11 x 15	20' - 30'	29	3 lbs	34.99
012131	A-2	14.5 x 19.5	30' - 40'	68	5 lbs	46.99
012132	A-3	17 x 23	40' - 50'	121	7 lbs	61.99
012133	A-4	20.5 x 27	50' - 60'	187	10 lbs	82.99
012134	A-5	27 x 36	60' - 70'	396	21 lbs	159.99
012135	A-6	34 x 44	70' - 100'	792	35 lbs	289.99

❖ For more detailed product specifications and our complete selection visit [www.defender.com](http://www.defender.com) or call 800-628-8225. ❖

## Polyform FenderFits Fender Covers

- Knit on, state-of-the-art machinery
- Fully protects your fenders from UV rays
- Minimizes damage from scuffs and marks
- Hand-finished by professional seamstresses
- Eliminates the "squeak" for a quiet mooring
- Durable, long lasting acrylic yarn

Please Specify Color: Green or Navy

Item	Model	For Polyform Models	For Fender Sizes"	Ship	Net
012251	A-4		20.5 x 27	2 lbs	\$87.99
012252	A-5		27 x 36	3 lbs	119.99
012253	A-6		34 x 44	4 lbs	135.99
012254	F-1, G-4		6 x 24, 6.5 x 22	1 lbs	23.99
012255	F-2		8.2 x 25	1 lbs	24.99
012256	F-3, G-5		8.2 x 30, 8.8 x 26.8	1 lbs	26.99
012257	F-4		8.5 x 40.5	2 lbs	54.99
012259	F-6		11 x 42	2 lbs	51.99
012260	F-7		15 x 41	2 lbs	58.99
012261	F-8		15 x 58	2 lbs	104.99
012262	F-10		18 x 50	3 lbs	115.99
012263	F-11		21.2 x 57.5	4 lbs	133.99
012264	HTM-2		Line-through	1 lbs	19.99
012265	HTM-3		Line-through	2 lbs	39.99
012266	HTM-4		Line-through	2 lbs	49.99



3 Year Warranty!



## Polyform Elite Fender Covers

- Made of long-lasting heavy duty polyester yarn
- Will not fade or become droopy
- Designed for the Polyform fender models A, HTM, F and G but suitable for other fenders of similar size and shape
- Color: Black or Blue
- Larger sizes available (Please inquire)

Item	Model	For Polyform Models	For Fender Sizes(inches)	Ship	Net
003342	EFC-1	NF-4, G-4, HTM-1, F-1	6 x 15 to 6.5 x 23	1 lbs	\$29.99
003343	EFC-2	F-2, G-5, HTM-2, NF-5	8 x 20 to 9 x 30	1 lbs	34.99
003344	EFC-3	HTM-3, G-6	10 x 26 to 10.5 x 30	2 lbs	37.99
003345	EFC-4	HTM-4	12 x 34	1 lbs	43.99
003346	EFC-5	F-5	12 x 30	1 lbs	43.99
003347	EFC-6	F-6	12 x 43	2 lbs	46.99
003348	EFC-7	F-7	15 x 41	2 lbs	49.99
003349	EFC-8	F-8	15 x 58	3 lbs	59.99
003350	EFC-10	F-10	18.5 x 50	3 lbs	77.99
003351	EFC-11	F-11	24 x 57	4 lbs	89.99
003352	EFC-13	F-13	32 x 77	5 lbs	159.99
003309	EFC-A1	A-1	11. x 15	1 lbs	55.99
003353	EFC-A2	A-2	15.5. x 19.5	1 lbs	59.99
003354	EFC-A3	A-3	18.5. x 23	1 lbs	71.99
003355	EFC-A4	A-4	21.5 x 28	1 lbs	85.99
003356	EFC-A5	A-5	27. x 30	2 lbs	136.99
003357	EFC-A6	A-6	34. x 46.5	3 lbs	193.99

## Polyform True-Fit Fender Holders

- Offers great versatility in mounting with a 360° swiveling connector
- Stainless Steel
- Connectors sold separately

Item	Model	Fender Size	Ship	Net
000815	TFR-170	Single 6"	1 lbs	\$46.99
000816	TFR-230	Single 8"	2 lbs	53.99
000817	TFR-280	Single 10"	2 lbs	61.99
001858	TFR-370	Tall 11" - 14"	36 lbs	119.99



Sold Individually

3 Year Warranty!

## True-Fit Fender Holder Connectors

Item	Model	Description	Ship	Net
000819	TFR-402	Swivel, 7/8 - 1" rails (each)	1 lbs	\$15.99
000820	TFR-403	Parallel (pair)	1 lbs	16.99
000821	TFR-404	Swivel, 1-1/8 - 1-1/4" rails (each)	1 lbs	17.99

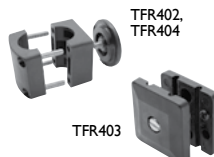

## Polyform High Pressure Valve Hand Pump

Designed specifically for polyform buoys and fenders and accommodates Polyform's unique valve.

Item	Model	Ship	Net
000920	#30 PUMP	1 lbs	\$32.99



## Polyform Inflation Adapter

For inflating Polyform fenders from compressed air or hand pumps.

Item	Model	Ship	Net
000869	#10	1 lbs	\$0.49



## Taylor Made Fenders & Accessories

### Taylor Made Super Duty Inflatable Yacht Fenders



- WELDED SEAMS! No glue to harden or breakdown!
- Heavy duty, spring-actuated valve with quarter turn lock for easy inflation and deflation
- 2" tubular nylon webbing exceeds 4500 lbs tensile strength
- 30% heavier material and 15% higher tensile strength than the competition
- Over 50% more abrasion resistant and twice as tear resistant than others
- Color: Black



5 Year Warranty!

Item	Model	Dimensions	Boat Size	Ship	Net
012322	SD1829B	18" x 29"	Up to 75'	5 lbs	\$192.99
012323	SD1842B	18" x 42"	Up to 75'	9 lbs	227.99
012324	SD1858B	18" x 58"	Up to 75'	9 lbs	265.99
012325	SD2442B	24" x 42"	Up to 100'	9 lbs	307.99
012326	SD2458B	24" x 58"	Up to 100'	12 lbs	339.99
012327	SD3648B	36" x 48"	Up to 150'	13 lbs	527.99

### Taylor Made Yacht Fender Covers

- Heavy duty sewn-in draw string with barrel lock ensures custom fit
- 100% heavy duty loop knit acrylic
- **Specify:** Black or Navy

Item	Dimensions	Ship	Net
012334	18" x 29"	2 lbs	\$74.99
012335	18" x 42"	3 lbs	97.99
012336	18" x 58"	3 lbs	129.99
012337	24" x 42"	3 lbs	129.99
012338	24" x 58"	4 lbs	177.99
012339	36" x 48"	6 lbs	219.99

### Taylor Made Pontoon Fender

- Specifically designed to fit snugly between the pontoon and the deck of the boat protecting both from rafting boats, docks or other objects
- Molded in ridge hooks underneath pontoon deck to help secure fender in place
- Made from Taylor Made marine-grade, UV resistant vinyl with an integrated rubber football style valve for easy inflation

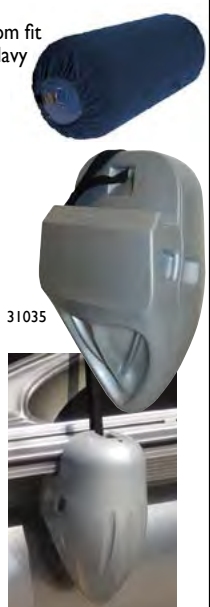

**Specify:** White or Silver

Item	Model	Dimensions	Ship	Net
012328	31030	White 9" x 16"	5 lbs	\$38.99
	31035	Silver 9" x 16"	5 lbs	42.99

### Taylor Made Modular Flat Fenders

- Made from closed cell EVA
- Won't puncture or absorb water
- Flat design keeps them from rolling or riding up
- Fasten together with hook and loop strap to create a modular system
- Can double as a knee pad or seat cushion

Item	Model	Fender Size	Ship	Net
012419	311	20" x 8" x 2"	1 lbs	\$38.99
	314	24" x 12" x 3"	2 lbs	83.99
	317	36" x 12" x 3"	2 lbs	105.99

### Taylor Made Stainless Steel Fender Racks

- Holds any style fender
- High gloss 316 Stainless Steel, completely pre-assembled and tightens to accommodate any angle
- Moveable "J" hooks mount on 1" to 1-1/8" rail or stanchion
- Folds flat for storage

Item	Model	Size	Ship	Net
000810	2009	Double 7" to 9"	6 lbs	\$149.99
000811	2011	Double 9" to 11"	7 lbs	169.99

### Taylor Made Fleece Fender Cover

- Constructed of 100% polyester 12 oz. blizzard fleece
- Ultra soft boot will not mar your boat's gel coat
- Reinforced brass grommet on the top
- Adjustable tie on the bottom for a snug fit
- Fits center-hole style fenders

Item	Please Specify Color	Size	Ship	Net
012309	Black or Navy	8" Dia x 20" L	1 lbs	\$32.99
012310	Black or Navy	10" Dia x 26" L	1 lbs	37.99

### Premium Fender Cover

- 100% Premium Polyester knit fabric
- UV Protected, abrasion and mildew resistant
- Fits Big B, Hull Gard and Super Gard Fenders

**Specify:** Navy or Black

Item	Size Dia.	Length	Ship	Net
002216	5-1/2" to 6-1/2"	15" to 23"		\$25.99
002217	8" to 8-1/2"	20" to 27"		28.99
002218	10" to 10-1/2"	26" to 30"		32.99
002219	12" x 34" (Big B only)			36.99



### Taylor Made Storm Gard™ Fenders

- Integrated Storm Gard pearlescent color agents provide added luster in sunlight
- Rubber football needle valve for easy inflation
- Color matches depth of gelcoats on most boats
- Valve seats are integrally molded into the fender, not glued
- Reinforced molded-in eyelet

**Specify:** Black Onyx, Captain's Navy, Emerald Green, Silver Mist or White

Item	Size	Boat size	Ship	Net
012319	5.5" x 20"	15-20'	2 lbs	\$15.99
012320	6.5" x 22"	20-25'	3 lbs	23.99
012321	8.5" x 27"	25-35'	5 lbs	45.99

### Taylor Made Big B™ Inflatable Vinyl Fenders

- Incorporates a center rope tube that allows end-to-end line passage
- Can be hung vertically or horizontally
- Features seamless construction, with molded ribs to minimize roll
- Big B's are made from the highest quality marine grade vinyl with a high gloss finish

**Specify:** White, Blue, Black, Sand or Navy.

Item	Boat Size	Fender Size	Ship	Net
012230	20'-25'	6" x 15"	3 lbs	\$35.99
012231	25'-35'	8" x 20"	5 lbs	44.99
012232	35'-50'	10" x 26"	8 lbs	76.99
012233	50'-60'	12" x 34"	12 lbs	105.99

Recommended inflation is 2 PSI.

### Taylor Made Hull Gard® Inflatable Vinyl Fenders

- Unique oval design prevents the fender from rolling out of position
- Combines unsurpassed softness and superior strength to provide boaters with the maximum protection available from a utility fender

Item	Please Specify Color	Boat Size	Fender Size	Ship	Net
012235	White or Blue	10' - 15'	4-1/2" x 16"	2 lbs	12.99
012236	White, Blue, Sand or Navy	15' - 20'	5-1/2" x 20"	2 lbs	16.99
012237	White, Blue, Sand or Navy	20' - 25'	6-1/2" x 23"	3 lbs	23.99
012238	White, Blue, Sand or Navy	25' - 35'	8-1/2" x 27"	4 lbs	44.99
012239	White, Blue, Sand or Navy	35 - 50'	10-1/2" x 30"	5 lbs	61.99

Recommended inflation is 2 PSI.

### Taylor Made Tidy-Ups Line Holder

- UV resistant vinyl
- Strap holds rope, cords, etc.

Item	Model	Rail Size	Ship	Net
011717	1101	1" - 1.25"	1 lbs	\$8.99
000700	1019	1.5" - 2"	1 lbs	9.99

### Taylor Made Hook & Loop Fender Straps

- A quick and easy way to adjust the height of your fenders
- Loop through fender, pull strap through buckle to desired length
- 3/4" wide Black polyester webbing
- UV protection and marine grade hook and loop

Item	Model	Length	Ship	Net
012296	1094	36" (each)	1 lbs	\$7.99/Pair

### Taylor Made Tidy-Ups Fender Adjuster

- Easy to use - simply snap over your lifelines or railing
- Holds lines up to 5/8" in diameter

Item	Model	Description	Ship	Net
001261	1015	White vinyl	1 lbs	\$13.99

### Taylor Made Lifeline Fender Clip

- Injection molded polyethylene
- Mounts securely to 3/16" - 1/4" lifelines
- Use for hanging fenders, holding power cords, etc.

Item	Model	Ship	Net
001264	1096	2 lbs	\$7.99/Pair

### Taylor Made Big B Fender Hanger

- Injection molded reinforced nylon for strength
- Vented to prevent water accumulating in fender tube
- Fits 3/8" diameter rope

Item	Model	Ship	Net
001828	1085	(3) per pack	1 lbs \$9.99

ANCHORING & DOCKING • Fenders & Accessories

PHONE 800-628-8225 • FAX 800-654-1616

## Fender Accessories & Cape Hatteras Custom Mats



### Buccaneer Double Braid Fender Lines

• Durable, abrasion resistant (2-Pack)  
 Please specify: Black, Blue, Gold/White, Hunter Green or White

Item	Eye diameter	Size	Ship	Net/Pair
001804	12"	3/8" x 6'	1 lbs	\$14.99



### Fender Lines (White, 2-Pack)

• Made of double braid rope with a spliced loop at one end

Item	Model	Size	Ship	Net
012386	40921	3/8" x 6'	1 lbs	\$14.99



### New World Fendergrip® Push Button Fender Adjuster

• Push button height adjustment with a positive lock  
 • Easily attaches fenders to cleats and rails of any size

Item	Model	Description	Ship	Net
001739	FX-8	Single	1 lbs	\$17.99
001999	FX-8/6	6-Pack	2 lbs	89.99

### fastfender Fender Hangers (Pair - Ship 1 lbs)

• Very lightweight, carbon-based material – extremely strong  
 • Resistant to temperatures of between -10° and +110° F  
 • Attach and remove fenders quickly  
 • Will not scratch or damage the railing



Please specify: Black, Blue or White

Item	Model	Fits Rail	Rope Size	Net
002416		Up to 5/16"	1/4" - 1/2"	\$15.99
002417	25	Up to 1"	1/4" - 1/2"	15.99
002418	32	Up to 1-1/4"	1/4" - 3/8"	21.99
002419	40	Up to 1-1/4"	1/4" - 9/16"	23.99

### Boatmates Fish On! Fender Cleats (Pair)

• Spring-loaded (provides quick solution for positioning fenders)  
 • An upscale alternative to polyethylene cleats  
 • 316 polished stainless steel. For rope up to 3/8" thick

Item	Model	Size	Ship	Net/Pair
000143	2201-2	4"L x 1"W x 1"H	1 lbs	\$37.99



### MDR Fender Cleaner

• Easily removes dirt, grease, oil and grime  
 • Wet down fender, squirt a small amount of spray and wipe off

Item	Model	Size	Ship	Net
751117	MDR-748	16 oz spray	2 lbs	\$9.99

### Custom Embroidered Fender Cover

• Easy to use, easy to clean and is the best choice for fender covers  
 • Fits Taylor Made and Polyform fenders only  
 • Made with "Ultra-V-TEX," a highly abrasion and UV resistant material  
 • Ships direct from manufacturer

Please specify cover color: Black, Navy or Tan  
 Please specify thread color: White, Silver, Black, Gold or Baby Blue  
 Please specify font: *Brush*, *Signature*, *Goudy*, **Block**,

*Designer*, or *Prestige* (Angled text available by special request.)  
 Note: Block, Goudy and Designer fonts are available in lower case and also in all capital letters. Signature, Brush and Prestige fonts: only the first letter is available in a capital.

Item	Centerline Fender Cover Size	Ship	Net
000261	For 6" x 15"	1 lbs	\$27.99
000249	For 8" x 20"	1 lbs	36.99
000250	For 10" x 26"	1 lbs	45.99
000251	For 12" x 34"	2 lbs	52.99

### Welcome Aboard & Lighthouse Mats

• Plush and durable with a non-skid rubber backing  
 • Mold and mildew resistant and highly UV protected

Please specify for **Welcome Aboard**: Tan w/Black lettering, Navy w/Gold lettering or Black w/Silver lettering

Item	Design	Ship	Net
650904	Welcome Aboard, 17" x 24"	2 lbs	\$24.99

Please specify for **Lighthouse**: Navy w/White lettering or Tan w/Navy lettering

Item	Design	Ship	Net
650909	Lighthouse, 17" x 24"	3 lbs	\$24.99

### Custom Mats

Select mat color, thread color, font and message.  
 • Ships direct from manufacturer  
 Please specify mat color: Black, Navy or Tan  
 Specify thread: White, Silver, Black, Gold or Baby Blue

Specify font: *Brush*, *Signature*, *Goudy*, **Block**, *Designer* or *Prestige*.

Note: Block, Goudy and Designer fonts are available in lower case and also in all capital letters. Signature, Brush and Prestige fonts only the first letter is available in a capital.

Item	Size	Ship	Net
650906	17" x 24"	3 lbs	\$45.99
650907	21" x 30"	4 lbs	56.99
650908	17" x 33" half circle	2 lbs	52.99

Please call 800-628-8225 to place your custom order.

## Boarding Steps, Handles & Ladders



### Plastimo Fender Ladders

Multi-function fender ladder protects topsides and enables easy access on board. All are 25 cm W x 12 cm D.

Item	Model	Color	Description	Length	Ship	Net
002676	186363	Blue	2-step fender	55 cm	6 lbs	\$94.99
	186365	Blue	3-step fender	75 cm	9 lbs	114.99
	186367	Blue	4-step fender	95 cm	13 lbs	124.99
003397	P186362	White	2-step fender	55 cm	6 lbs	94.99
	P186364	White	3-step fender	75 cm	9 lbs	114.99
	P186366	White	4-step fender	95 cm	13 lbs	124.99

### Edson One Step Boarding Step

• Foundry cast with durable, White, baked-on coating  
 • Attaches to lifeline gate stanchions and hangs against the side of the boat  
 • Built-in neoprene bumpers won't mar your topside  
 • Built-in handles give you a great handhold  
 • Complete with 6' line and stainless steel snap shackles



Item	Model	Ship	Net
011512	520-14	6 lbs	\$281.99

### Come On Board Handle

• Multiple piece design for easy storage  
 • Unique finger molded groove handle design for comfort grip  
 • Packaged in mesh bag for easy drying if stored wet and to avoid scratching deck or storage surfaces on the boat  
 • One year limited warranty



Item	Model	Handle	Ship	Net
002796	F16-0800	supplied with one base	9 lbs	\$239.99
002797	F16-0800C	Base	2 lbs	69.99

Additional base for multiple locations

### Windline Boarding Handle

• Fits in any 30° flush mount fishing rod holder  
 • Provides secure yet removable handhold for boarding  
 • Overall height: 33-1/2"

Item	Model	Description	Ship	Net
000169	BH-1	Stainless steel	6 lbs	\$123.99

### Windline Over Platform Telescoping Ladder

• TDL-4X features 10" of additional reach when deployed  
 • Requires only 1.5" more storage space  
 • Made of stainless steel

Item	Model	Description	Ship	Net
000167	TDL-3X	3 step ladder, Length deployed: 34", Stowed: 16"	6 lbs	\$125.99
000168	TDL-4X	4 step ladder, Length deployed: 44"; Stowed: 16.5"	9 lbs	164.99

### Windline Slide Mount Ladders

• Stainless steel construction

#### 3 Step

Overall width: 12-1/4"  
 Centerline width: 10"  
 Length stowed: 14-5/8"  
 Length deployed: 34"

#### 4 Step

Overall width: 14"  
 Centerline width: 12"  
 Length stowed: 16"  
 Length deployed: 44"

Item	Model	Description	Ship	Net
001914	SM-3XOC	3 step	9 lbs	\$189.99
001915	SM-4XB	4 step	15 lbs	314.99

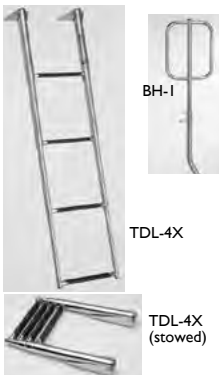

### Windline Dive Ladders

• Stainless steel tubing with wrap around PVC tread for foot comfort  
 • Rated at 400 lbs load capacity  
 • Center bar design for obstacle-free ascent  
 • Includes quick release mount

Item	Model	Description	Ship	Net
000165	DL-3X	3 step ladder; 36"L deployed	10 lbs	\$172.99
000166	DL-4X	4 step ladder; 46"L deployed	12 lbs	197.99

### Windline Ladder Transom Mount

• Designed for Windline dive ladders  
 • Slide pin secures ladder when in use  
 • Combine with DLB-2 to mount under swim platform

Item	Model	Ship	Net
001913	DLB-3	2 lbs	\$49.99



## Ladders & Boat Steps

### International Dock Products

#### Ladders

- Use for docks and seawalls
- Constructed of marine grade aluminum pipe for salt and fresh water
- Ladder rungs are separated in 1' increments and are extruded with grooves to give you a non-skid surface
- The 1-1/4" inch diameter handrail is convenient for finger docks where minimal space is available
- Available in 3-, 4-, 5-, 6-, & 7-step lengths \*(3-, 4-, 5-step only)
- Your choice of 2" standard or 4" comfort rungs



Item	Application	Type	Prices starting at
<b>D</b> 003310	Dock or seawall mount	Lifting	\$184.99
<b>D</b> 003313*	Floating dock mount	Lifting	189.99
<b>D</b> 003312	Dock or seawall mount	Swing	204.99
<b>D</b> 003311	Dock or seawall mount	Fixed	144.99

### DOTLINE

- Anodized aluminum
- 15" wide plastic steps
- Folds flat for easy storage
- Guaranteed against breakage under normal use for one year
- Stainless steel mounting brackets included with deck and side mount ladders

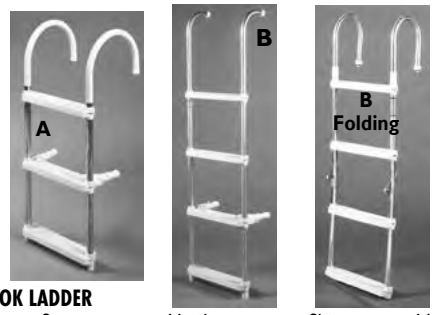

#### A. GUNNEL MOUNT DELUXE HOOK LADDER

Item	Model	Size	Height	Ship	Net
<b>Ladder - 11" Hook</b>					
001522	PL-3WA	3 step	36" H	4 lbs	\$44.99
001523	PL-4WA	4 step	47" H	5 lbs	48.99
<b>Ladder - 7" Hook</b>					
001524	PL-3A	3 step	36" H	4 lbs	\$44.99
001525	PL-4A	4 step	47" H	5 lbs	48.99

#### B. DECK MOUNTING LADDERS

Item	Model	Size	Height	Ship	Net
001530	PDM-3A	3 step	37" H	6 lbs	\$81.99
001531	PDM-4A	4 step	48" H	8 lbs	89.99
<b>Folding Deck Mount - Bottom step folds up</b>					
001533	FDM-4A	4 step	26" to 46" H	9 lbs	\$87.99
001534	FDM-5A	5 step	37" to 57" H	9 lbs	99.99
001535	FDM-6A	6 step	48" to 68" H	11 lbs	107.99

#### Accessories For Dotline Ladders

Replacement/additional set of adjustable (6"-9") leg support brackets

Item	Model	Ship	Net
001547	CLS-2	1 lbs	\$11.99

Set of (2) stainless steel mounting brackets

Item	Model	Ship	Net
002635	SMB-2	1 lbs	15.99



### Cockpit Steps

- For stepping up or down from cockpit of all types of cruisers
- Attaches to inside of coaming with stainless steel brackets (included)
- Anodized aluminum uprights

#### ALUMINUM/OAK

Item	Model	Dimensions	Ship	Net
650983	25022	16" W x 5.5" D x 22" H	8 lbs	\$124.99
<b>D</b> 650984	25028	16" W x 5.5" D x 28" H	56 lbs	144.99

#### ALUMINUM/POLYETHYLENE

Item	Model	Dimensions	Ship	Net
650982	25122	15" W x 5.5" D x 22" H	10 lbs	199.99

#### ACCESSORIES

Item	Model	Description	Ship	Net
650985	76000	Shur-Loc catches, pair	1 lbs	15.99



### Deluxe Tournament Cockpit Step

- A portable, convenient and classy addition to any boat or yacht
- Makes entering and exiting your boat or yacht easy for everyone
- The step also has interior storage for dock lines, etc.
- Dimensions: 15.5" D x 19.25" W x 13" H

Item	Model	Ship	Net
Item 655345	Model BS-01	Ship 12 lbs	Net \$221.99



### todd Boat/Dock Steps

- Todd's boat steps make access to your boat safe and convenient
- Molded from durable White polyethylene

Item	Model	Steps / D" x W" x H"	Ship	Net
002624	91-2333	Single Step 19-1/4 x 15-1/2 x 11-15/16	12 lbs	\$78.99
<b>D</b> 002625	91-2334	Double Step 21-3/4 x 20-1/4 x 17-1/4	58 lbs	143.99
<b>D</b> 011792	91-2335	Triple Step* 31-3/4 x 20-1/4 x 26	97 lbs	304.99
<b>D</b> 011793	93-2336	Quad Step*, 36 x 20 x 32	104 lbs	403.99

\* Includes handrail.

#### Stainless Steel handrails for Todd Boat Steps

(Fasteners included) Mounts left or right.

Item	Model	Description	Ship	Net
002627	91-2348	Handrail for double step	4 lbs	\$86.99
011790	11-2353	Handrail for triple step	4 lbs	94.99
011791	11-2354	Handrail for quad step	4 lbs	104.99

Note: These handrails will not fit Todd Boarding Steps manufactured prior to January 1st 2011.



### StepSafe™ Dock Steps

- Durable, UV resistant polyethylene
- StepSafe non-slip pad is adhered on the top of each step for additional slip protection while boarding



- Can be screwed down to the dock, if desired, through the mounting holes on the base flange
- Lightweight for easy movement in yards or marinas where a permanent solution is not available, such as on gravel

Item	Model	Description	Ship	Net
000752	47100	Single step, 22" L x 18" W x 11-1/2" H	11 lbs	\$89.99
<b>D</b> 000753	47200	Double step, 26-3/4" L x 23-1/2" W x 17" H	53 lbs	144.99
<b>D</b> 000755	47300	Triple step, 35" L x 25" W x 25-1/2" H	116 lbs	192.99
000754	47201	Aluminum handrail for double step	6 lbs	75.99
000757	47301	Aluminum handrail for triple step	7 lbs	86.99

Note: Optional handrails sold separately.



## Garelick Swim Platforms

### I/O Swim Platform Without Ladder

- Features:**
- Includes reversible (2) 1" stainless wraparound rail and (1) 1" underside support rail
  - Durable HDPE platform is pre-drilled for easy assembly
  - Mounts at 10° angle on transom



- Specifications:**
- Platform material: High density, White polyethylene
  - Railing: 1" diameter wrap around railing
  - Railing material: Stainless steel
  - All stainless steel hardware
  - Platform dimensions: 18" W x 15" D
  - Platform thickness: 0.75"

Item	Model	Ship	Net
001988	19540	14 lbs	\$114.99

### Outboard Transom Platform & Telescoping Ladder

- Features:**
- (1) 1" stainless steel wraparound and (1) 1" underside support rail
  - Durable HDPE platform is pre-drilled for easy assembly
  - Mounts at 10° angle on transom
  - Ladder slides up and under platform for stowage



- Specifications:**
- Platform material: High density, White polyethylene
  - All stainless steel hardware
  - Platform thickness: 0.75"
  - Platform dimensions: 18" W x 15" D
  - Ladder: 23.5" L (deployed), 13.5" L (stowed), 11.25" W

Item	Model	Ship	Net
001989	19536	17 lbs	\$199.99

### I/O Transom Platform & Telescoping Ladder

- Features:**
- (2) 1" diameter stainless wrap around rails
  - Durable HDPE platform is pre-drilled for easy assembly
  - Mounts at 10° angle on transom
  - Ladder slides up and under platform for stowage



- Specifications:**
- Platform material: High density, White polyethylene
  - All stainless steel hardware
  - Platform thickness: 0.75"
  - Platform dimensions: 18" W x 15" D
  - Ladder: (2) Steps with comfortable flat poly treads
  - 23.5" L (deployed), 13.5" L (stowed), 11.25" W

Item	Model	Ship	Net
001990	19546	18 lbs	\$199.99

#### WHITE WATER SWIM PLATFORM MOUNTING BRACKET

- 304 Stamped stainless steel
- Tubing: 7/8" diameter

Item	Size	Angle	Ship	Net
003296	6" H x 12" W	12°	1 lbs	\$26.99
	6" H x 12" W	16°	1 lbs	26.99
	9" H x 17" W	12°	1 lbs	41.99

ANCHORING & DOCKING • Steps, Ladders & Platforms PHONE 800-628-8225 • FAX 800-654-1616

## Dock & Post Bumpers

### PLASTIMO THE BUMPER DOCK FENDER

#### Air-Filled, Articulated

Save yourself anxious moments approaching the dock - especially if you're a singlehander - and prevent damage to your boat when wind and current are working against you. The Bumper dock fender, installed on pontoons or docks, is a highly efficient fender that protects your boat's bow and hull from damage caused by contact with the dock.

- Made of sturdy, UV-resistant rotomolded PVC
- Ideal for boats over 30' and for commercial pontoons
- Secures to dock with screws
- Bends around curves and sharp corners in the dock for added protection



Item	Model	Description	Ship	Net
002685	39146	7" Dia x 31.2" L, White	6 lbs	\$89.99

### Plastimo Pole for Plastimo Dock Bumper

Add an optional dockline pole to the bumper and enhance your safety each time you cast off and dock by eliminating the need for a crewmember to jump to the dock or leap onto the boat at the last minute. Whether casting off or picking up your mooring lines, you operate in optimum safety conditions: your line is always handy.

Item	Model	Length	Ship	Net
002686	29640	111 cm	2 lbs	\$74.99

### PLASTIMO BUMPER DOCK FENDERS-WHITE

- Made of sturdy, UV-resistant rotomolded PVC
- Provides additional security from damaging your vessel against the dock, especially when the wind is whipping and the current is against you
- The articulated bumper bends around curves and sharp corners of the dock for added protection
- Secures to the dock with screws or optional fastening clamps



				1/2 Round	
Item	Model	Description	Dimensions	Ship	Net
002422	38558	Small air filled	7.1" dia. x 15.7"L	4 lbs	\$49.99
002423	38068	Large air filled	9.8" dia. x 35.4"L	6 lbs	114.99
002234	39362	Large foam filled	9.8" dia. x 35.4"L	14 lbs	279.99
				3/4 Round	
002421	38082	Small air filled	7.1" dia. x 15.75"L	4 lbs	\$52.99
000743	30102	Large air filled	9.8" dia. x 35.4"L	12 lbs	119.99
002420	37783	Large foam filled	9.8" dia. x 35.4"L	16 lbs	299.99

### Accessories for both 1/2 & 3/4

002197	36663	Fastening clamps (3")	1 lbs	\$22.99
--------	-------	-----------------------	-------	---------

### STANPRO RUBBER DOCK BUMPER

- For docks and pilings
- Gray rubber
- Sold by the foot

Item	Model	Type	Size	Ship	Net/Ft.
<b>SINGLE</b>					
000943	75000664	Standard	2-3/8" W x 1-3/8" H	1 lbs	\$6.29
000944	75000660	Heavy duty	3-3/8" W x 1-7/8" H	2 lbs	8.99
<b>DOUBLE</b>					
000942	75000659	Heavy duty	4-1/4" W x 1-7/16" H	2 lbs	\$13.49

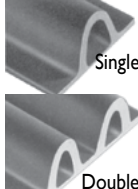

## Gunnel Guard & Rub Rail

### STAINLESS STEEL RUB RAIL

Sturdy, solid and flexible to withstand the most severe conditions and afford the maximum in protection. Countersunk and drilled every 6". Highly polished type 304 stainless. Half oval.



Item	Model	Length	Width	Thick	Screw Size	Ship	Net
002043	1400-187-8	8'	3/4"	3/16"	10	3 lbs	\$62.99
000822	1400-187-12	12'	3/4"	3/16"	10	5 lbs	93.99
002044	1500-250-8	8'	1"	1/4"	12	4 lbs	99.99
000823	1500-250-12	12'	1"	1/4"	12	8 lbs	141.99

### TAYLOR MADE PERIMETER GUNNEL GUARD

- Polyester covered!
- Maximum 50' continuous length
- Wears over 10 times longer than similar products
- Will not rot in the sun or mar your boat
- Flexible cushion and tabs for easy attachment with screws and washers - Perfect for Whalers, dinghies and swim steps



Item	Model	Description	Dia.	Tab Size	Net/ft.
000947	GGI.53Q.50	3/4 round	1-1/2"	3/4"	\$8.99
000948	GGI.5HR.50	1/2 round	1-1/2"	5/8"	8.99

### TAYLOR MADE PERIMETER DOCK BUMPERS

Polyester textile and foam cushion, NOT vinyl, PVC or rubber! For horizontal or vertical applications. Will not deteriorate in the sun or mar your boat. Easy to clean with liquid soap. Flexible tab system allows mounting on curves or around corners.



Item	Model	Length	Dimensions	Ship	Net
000778	DB2.60	6'	3-5/8" W x 1-1/4"D	2 lbs	\$36.99
000779	DB2.90	9'	3-5/8" W x 1-1/4"D	3 lbs	45.99
000780	DB3.30	3'	4-1/2" W x 1-3/4"D	2 lbs	36.99
000781	DB3.60	6'	4-1/2" W x 1-3/4"D	3 lbs	49.99
000782	DB3.90	9'	4-1/2" W x 1-3/4"D	3 lbs	69.99
000783	DB4.30	3'	5-1/2" W x 2-1/4"D	2 lbs	42.99
000784	DB4.60	6'	5-1/2" W x 2-1/4"D	3 lbs	69.99
000785	DB4.90	9'	5-1/2" W x 2-1/4"D	4 lbs	89.99

### TAYLOR MADE WHITE DOCK CUSHION

- Dimensions: 3.25"D x 5"H x 36"L
- Material: UV protected foam
- Mounting: Horizontal or vertical
- Maintenance free, non-marring, provides superior cushioning



Item	012329	Model	46011	Ship	2 lbs	Net	\$30.99
------	--------	-------	-------	------	-------	-----	---------

### TAYLOR MADE WHITE DOCK CUSHION CORNER BUMPER

- Dimensions: 3.25"D x 5"H x 18"L
- Material: UV protected foam
- Mounting: Horizontal
- Maintenance free, non-marring, provides superior cushioning



Item	002835	Model	45984	Ship	2 lbs	Net	\$35.99
------	--------	-------	-------	------	-------	-----	---------

### TAYLOR MADE - PERIMETER REMOVABLE POST BUMPERS

These Post Bumpers stay in place better than fenders. Polyester webbing and heavy-duty Delrin® buckle system makes installation quick, easy and secure. Great for temporary docking or portable docks.

Item	Model	Size L x W x D	Ship	Net
000790	RPB3.30	3' x 4-1/2" x 1-3/4"	2 lbs	\$43.99
000791	RPB4.30	3' x 5-3/4" x 2-1/4"	2 lbs	52.99



### JIM BUOY CORNER DOCK BUMPER

Protects boats and crew from damage at dock corners and preserves the dock too! Also used on carts or bins to protect walls and doorways. UV inhibited White marine vinyl.



Item	Model	Size	Ship	Net
000747	5007	8" x 8" x 4"	2 lbs	\$19.99

### TACO PRECUT FLEXIBLE VINYL BOAT DOCK BUMPER

- White flexible dock bumper
- Mounting hardware is not included



Item	Model	Size H x D x L	Ship	Net
002641	V11-0948WHA20	3-3/8" x 1-1/4" x 20'	41 lbs	\$64.99
002642	V11-0948WHA6	3-3/8" x 1-1/4" x 6'	12 lbs	27.99

### TACO PRECUT FLEXIBLE VINYL BOAT DOCK BUMPER

- White vinyl flexible dock bumper with (1) 90° tab
- Mounting hardware is not included



Item	Model	Size H x D x L	Ship	Net
002643	V11-0961WHA6	2-1/4" x 1-7/8" x 6'	12 lbs	\$27.99

### TAYLOR MADE DOCK PRO™ HEAVY DUTY VINYL DOCK BUMPER

- UV resistant, marine-grade vinyl provides superior impact protection
- Inflate to desired firmness; pre-drilled, mount with plated fasteners



Item	Model	Description	Size L x W x H	Ship	Net
012278	45500	Straight	35-1/2" x 4" x 5"	9 lbs	\$89.99
012279	45510	Corner	13" x 4" x 5"	5 lbs	79.99

### TAYLOR MADE 90° VINYL CORNER BUMPER

- Inside structural ribs provide impact resistance
- Flush fit 6" side sections give installation a "finished" appearance



### TAYLOR MADE DOCK PRO VINYL DOCK BUMPER

- Tough marine grade vinyl protects the side and top of the dock
- Solid flaps attach easily to any dock
- Specify: Black or White



Item	Model	Description	Size	Ship	Net
012281		Straight	18"	2 lbs	\$16.99
012282		Corner	10" x 10"	2 lbs	15.99

### TAYLOR MADE FENDER BOARD GUARDS

Attach to both ends of a 2" x 4" and these rubber cushions will give you a padded fender board. Measures 4" x 4" x 3".



Item	Model	Color	Ship	Net/Pair
755428	96011	White	2 lbs	\$29.99

### TAYLOR MADE DOCK PRO INFLATABLE DOCK WHEEL

Rugged dock wheels feature football style valves, galvanized steel shaft and base with predrilled holes for quick mounting. Available in corner or straight mount style.



Item	Model	Description	Ship	Net
000714	1078	9" corner	5 lbs	\$74.99
000715	1079	9" straight	5 lbs	71.99
011674	1072	12" corner	11 lbs	134.99
011675	1073	12" straight	14 lbs	123.99
000266	1081	18" corner	17 lbs	175.99

### REPLACEMENT DOCK WHEEL

Replacement wheels for 1072 and 1081 above. Hardware sold separately.

001979	91072	12" wheel	2" axle	Ship 4 lbs	Net \$61.99
990028	91082	18" wheel	2" axle	7 lbs	78.99



## Mooring Whips

### TAYLOR MADE MOORING WHIPS

Provides reliable protection against costly dockside and seawall damage. Ideal for any side-tie or other docking situation involving wake or surge action that would otherwise push your boat against the dock. Poles are constructed from quality tapered fiberglass which provide increased strength and reflex action as the boat nears the dock.



### "EZ-Board" Roller Tips

Allows your boat to return to the dock effortlessly when you want to board.



Each set comes complete with all hardware for installation.

### Standard Mooring Whips

Equipped with fixed angle bases and designed for ski boats, runabouts, center consoles and bass boats.



### Premium Mooring Whips

Equipped with unique rocker arm bases that return the whip poles to the vertical position when not in use. Ideal for sailboats and larger, heavier or higher profile boats.



### STANDARD MOORING WHIPS

Item	Model	Whip Length	Whip Dia.	Boat Length	Boat Weight	Ship	Net
000735	MW.080	8'	.813"	Up to 20'	2500 lbs	17 lbs	\$369.99
000736	MW.120	12'	.813"	18' - 23'	2500 - 5000 lbs	21 lbs	499.99
000737	MW.140	14'	.813"	24' - 28'	5000 - 10,000 lbs	23 lbs	549.99
000738	MW.160	16'	.813"	29' - 33'	10,000 - 20,000 lbs	90 lbs	569.99

### PREMIUM MOORING WHIPS

000739	PMW.1400	14'	1"	Up to 33'	Up to 20,000 lbs	32 lbs	759.99
000740	PMW.1600	16'	1"	34' - 46'	20,000 - 36,000 lbs	90 lbs	799.99
000741	PMW.1800	18'	1"	47' - 56'	36,000 - 48,000 lbs	90 lbs	817.99

### DOCKCATCHER®

Makes docking easier in crosswinds, when night docking, docking alone, in bad currents or weather and during emergencies. No more need for dockside assistance or having to jump off your boat to dock. Easy to install to dock - just 3 screws. Reflective tape for night docking.



Item	Model	Ship	Net
754320	DC-01RW	2 lbs	\$73.99

### LINECATCHER®

Coiled line can be pulled off this flexible hook if not within arm's reach. The solution for docking where extreme tides are not a factor. Vinyl holder and flexible hook will never damage hull or rigging. Reflective tape for nighttime landings. Simple installation.



Item	Model	Description	Ship	Net
754321	LC-01RW	Line Catcher (each) Red	1 lbs	\$43.99
754322	LC-01GW	Line Catcher (each) Green	1 lbs	43.99

### DR. SHRINK TIDEMINDERS™ SYSTEM

- Controls dock/mooring lines in tidal waters
- String of black balls protects lines against fouling and chafing
- Lines roll up and down any size piling with the tide
- Eliminates the need to constantly adjust lines
- As the balls move up and down they offer constant tension
- Requires no tools
- For use with up to 1" line (Sold separately)
- Package of 9 Black balls; fits 12" piling



Item	Model	Ship	Net
752463	DS-TMKITBLK	4 lbs	\$44.99

### ROCK 'N ROLL™ BOAT STABILIZER

- Patented hydrodynamic design
- Relies on shape rather than heavy weight
- Operates silently without noisy flapper valves or vanes
- Attaches to a "swing out" boom or spinnaker pole
- Reduces motion sickness and accidents caused by wind and sea conditions • Includes storage case
- Folds flat for storage: 10-1/2" W x 36" L x 3" H



Item	Model	Weight	Size	Ship	Net
400337	R10-702	18 lbs	36" x 21"	17 lbs	\$234.99

Outrigger System for use with Rock 'n Roll Stabilizer. Telescopes from 42" - 97".  
400338 R10-707 9 lbs \$244.99

### DOCK EDGE INSTACLEAT™ PORTABLE 5" CLEAT

- Cast aluminum with White polyester powder coat finish
- Stainless steel T-bar
- Installs securely in seconds
- Use whenever cleats are missing or are in an inconvenient location



Item	Model	Ship	Net
002328	DE2705WF	1 lbs	\$27.99

### DOCK EDGE PORTACLEAT™

- White powder coated steel • Portable and easy to store
- Fits neatly between dock timbers
- Twist 90° to lock in place



Item	Model	Ship	Net
002329	DE91107F	1 lbs	\$14.99

### DOCK EDGE EZE DOCKER™ PORTABLE MOORING RING

- All steel, zinc plated and leachate coated
- One-piece, spring-operated portable mooring ring
- When docking, insert between dock planks, press down and turn 90°



Item	Model	Ship	Net/Pair
002330	2701Z-F	1 lbs	\$18.99

### DOCK EDGE POLY LINE HOLDER

- Made from high impact Black polyethylene (HDPE)
- Mounts easily with (3) 1-1/2" or 2" screws (not included)



Item	Model	Ship	Net
002327	DE91409F	1 lbs	\$8.99

## Dock Boxes & Carts

### TAYLOR MADE STOW 'N GO DOCK BOXES

- Fiberglass molded
- UV gelcoat finish
- Stainless steel lockable latch and hardware
- Gas shock lifts standard on all models
- Constructed with a smooth interior finish which helps prevent splinters



All Taylor Made boxes are Drop Ship Only

Item	Model	Size (H x W x D)	Shape	Ship	Net
012244	83550	20" x 40" x 19"	Rectangular flat top	32 lbs	\$479.99
012245	83557	18" x 48" x 20"	Rectangular flat top	40 lbs	489.99
012101	83562	24" x 54" x 22"	Rectangular flat top	37 lbs	599.99
012102	83552	24" x 72" x 23"	Rectangular flat top	60 lbs	689.99
012103	83551	24" x 85" x 22"	Rectangular flat top	68 lbs	839.99
012240	83553	27" x 46" x 26"	Rectangular flat top	46 lbs	569.99
012241	83554	28.25" x 72.75" x 28.25"	Rectangular flat top	68 lbs	849.99
012242	83556	27" x 46" x 26"	Rectangular seat top	59 lbs	649.99
012243	83555	30" x 73" x 28.25"	Rectangular seat top	85 lbs	919.99
012246	83561	27" x 54" x 33"	Triangle flat top	60 lbs	604.99
012283	83560	24" x 95" x 22"	Rod holders under seat	138 lbs	829.99

### Replacement Parts and Accessories

755765	1844-10	Gas shock, Length: 7.5" x PI force: 10 lbs	1 lbs	\$46.99
755766	1852-50	Gas shock, Length: 20" x PI force: 50 lbs	1 lbs	49.99
755767	1894-10	Gas shock, Length: 20" x PI force: 10 lbs	1 lbs	69.99
755768	1895-10	Gas shock, Length: 12" x PI force: 10 lbs	1 lbs	43.99
755769	1883	Angled stainless steel mounting brackets (pair)	1 lbs	9.99/pr.
755770	1886	Flat 13 mm ball stainless steel brackets (pair)	1 lbs	25.99/pr.
755771	1888	Angled 13 mm ball stainless steel bracket	1 lbs	25.99 ea.
755772	1890	13 mm ball stud stainless steel	1 lbs	8.99 ea.
755773	1892	10 mm" ball stud stainless steel	1 lbs	7.99 ea.

### TRAC FOLDING DOCKHAND UTILITY CART

- Aluminum telescoping frame folds flat
- (2) 6.5" diameter rubber wheels
- Foam grip handle for comfortable control
- Dimensions: 18.9" x 18.9" x 38.6" (Open) / 2.4" x 18.9" x 28.7" (Flat)
- Maximum capacity: 220 lbs



Item	002850	Model	T10042	Ship	10 lbs	Net	\$52.99
------	--------	-------	--------	------	--------	-----	---------

### OMC OUTDOOR PRODUCTS TitanSTOR™ ROTO-MOLDED DOCK BOXES

- The toughest, eco-friendly, premium dock boxes in the marine industry
- Constructed of custom roto-molded polyethylene
- UV resistant protection from moisture, sunlight and saltwater degradation
- Marine industry's only CRACK-PROOF GUARANTEE
- All stainless steel hardware, keyed-alike lock set with keys and open-lid suspension
- All OMC dock boxes are Drop Ship only
- Color: White



Item	Model	Dimensions	Ship	Net
003420	35-15005-L-WW	48" L x 27" H x 24" D	67 lbs	\$539.99
	35-15004-L-WW	71" L x 27" H x 24" D	92 lbs	609.99
	35-15000-L-WW	84" L x 27" H x 24" D	109 lbs	699.99

### TAYLOR MADE DOCK PRO™ DOCK CART

- Curved handle design is easier on your back
- Angled tub feature provides better leg clearance
- 7 cu. ft., heavy wall roto-molded poly-tub, no rust
- Zinc coated corrosion resistant hardware
- Plastic rim wheels with roller bearings will stand up to the harshest marine environments
- 47" L x 23" W x 13" D



Item	Model	Capacity	Wheel Size	Wheel Type	Ship	Net
012145	1070	300 lbs	20"	Pneumatic (inflatable)	103 lbs	\$267.99
012295	1060	300 lbs	20"	Solid	107 lbs	267.99

❖ For more detailed product specifications and our complete selection visit [www.defender.com](http://www.defender.com) or call 800-628-8225. ❖



NEW ENGLAND ROPES

**Cordage/Line**

**STA - SET FLECK COLORS**

**THE #1 PERFORMANCE BRAID IN AMERICA**

Sta-Set is the quintessential proven performance double braid with superior durability and dependability. Sta-Set is a strong, flexible and long wearing line.

**Features:** • Superior abrasion resistance, durable cover • Easy to handle and splice • Different color flecks make identifying each line quick and easy.

**Applications:** • Mainsheets • Control Lines • Jib Sheets

**Colors Available:** • Red Fleck • Green Fleck • Blue Fleck



Item	Size	Size	Average Tensile Strength	Weight lbs/100'	Net/Ft
609006	3/16"	5 mm	1,400 lbs	1.1 lbs	\$0.30
609007	1/4"	6 mm	2,350 lbs	2.0 lbs	0.45
609008	5/16"	8 mm	3,850lbs	3.1 lbs	0.55
609009	3/8"	10 mm	5,100 lbs	4.3 lbs	0.75
609010	7/16"	11 mm	7,000 lbs	6.0 lbs	0.95
609011	1/2"	12 mm	10,100 lbs	7.8 lbs	1.20

**THE #1 PERFORMANCE BRAID IN AMERICA**



**BEST USE:**  
• HALYARDS • SHEETS • CONTROL LINES  
• FURLING LINES • ALL PURPOSE SAILING LINE

**VPC PERFORMANCE BRAID**

Utilizing Hybrid Performance Technology, VPC features a strong core of blended Vectran and polyolefin with a durable polyester cover.

**Features:** • High strength • Low stretch **Applications:** • Mainsheets • Halyards • Jib Sheets  
**Colors Available:** • Blue Fleck • Red Fleck • Green Fleck • solid White (no tracer) • solid Gray (no tracer) • solid Navy (no tracer)

Item	Size	Size	Average Tensile Strength	Weight lbs/100'	Net/Ft
600931	8 mm	5/16"	5,500 lbs	3.3 lbs	\$1.10
600932	10 mm	3/8"	6,500 lbs	4.75 lbs	1.42
600933	11 mm	7/16"	8,500 lbs	5.9 lbs	1.79

**NER STS - STRONGER THAN STEEL® HSR 75**

**Heat Set and Pre-Stretched Dyneema Rope**

This single braid is comprised of 100% Dyneema fiber that has been heat treated while under tension. At a microscopic level, this process causes the molecular chains to be oriented such that they are linear which allows loads to be distributed evenly across all the rope fibers. This process produces significant increases in tensile strength, and initial construction stretch is reduced to a minimum.

**Benefits:** • High breaking strength • Low constructional elongation

• Longer service life • Easy to splice

**Color:** Silver

Item	Size	Size	Average Tensile Strength	Weight lbs/100'	Net/Ft
608837	3 mm	1/8"	5,200 lbs	0.6 lbs	\$0.95
	5 mm	3/16"	9,475 lbs	1.3 lbs	2.11
	6 mm	1/4"	12,385 lbs	1.7 lbs	2.96
	7 mm	9/32"	18,700 lbs	2.5 lbs	3.49
	9 mm	23/64"	23,600 lbs	3.9 lbs	6.04

**VINTAGE 3-STRAND POLYESTER**

**Low Stretch Running Rigging for Traditional Vessels**

Traditional coloring just perfect for more traditional boats.

**Benefits:** Excellent abrasion resistance with low stretch and high strength. Easy to splice.

**Applications:** On dinghies and traditional boats, use for halyards and control lines.

**Color:** Tan

Item	Size	Size	Average Tensile Strength	Weight lbs/100'	Net/Ft
003335	1/4"	6 mm	1,450 lbs	1.67 lbs	\$0.59
	5/16"	8 mm	2,100 lbs	2.6 lbs	0.69
	3/8"	10 mm	3,450 lbs	4.4 lbs	0.81
	1/2"	12 mm	6,200 lbs	7.3 lbs	1.49
	5/8"	16 mm	8,100 lbs	15.0 lbs	1.95
	3/4"	18 mm	12,400 lbs	16.5 lbs	2.19

**STA - SET SOLID COLORS**

Sta-Set is the quintessential proven performance double braid. Strong, flexible, and long lasting High strength, low stretch, extremely durable, yet still remains soft over time.

**Features:** Superior abrasion resistance, durable cover • Easy to handle and splice.

**Applications:** All purpose sailing line for halyards, sheets, control lines and furling lines.

**Colors Available:** • Black • Navy • Red • Green • Blue • White

Item	Size	Size	Average Tensile Strength	Weight lbs/100'	Net/Ft
609001	1/4"	6 mm	2,350 lbs	2.0 lbs	\$0.45
609002	5/16"	8 mm	3,850lbs	3.1 lbs	0.65
609003	3/8"	10 mm	5,100 lbs	4.3 lbs	0.80
609004	7/16"	11 mm	7,000 lbs	6.0 lbs	1.05
609005	1/2"	12 mm	10,100 lbs	7.8 lbs	1.30

**Colors Available:** • White Only

609012	9/16"	14 mm	11,700 lbs	10.1 lbs	\$1.50
609013	5/8"	16 mm	16,900 lbs	11.9 lbs	1.75
609014	3/4"	18 mm	23,500 lbs	17 lbs	2.25

**REGATTA BRAID-WHITE**

Regatta braid is a supple, 12-strand, single-braid construction made with 60% filament polyester and 30% spun polyester. This combination makes for high strength, low stretch and great feel in your hand. Use it for mainsheets, jib sheets, control lines and furling lines.

• Soft and supple • Runs freely and does not kink

**Applications:** Mainsheets, jib sheets, control lines and furling lines

**Color:** White with Red tracer (thin tracer)

Item	Size	Size	Average Tensile Strength	Weight lbs/100'	Net/Ft
003336	1/4"	6 mm	2,550 lbs	2.2 lbs	\$0.49
	5/16"	8 mm	3,300 lbs	3.0 lbs	0.59
	3/8"	10 mm	4,800 lbs	4.0 lbs	0.79
	7/16"	11 mm	6,500 lbs	6.3 lbs	0.99
	1/2"	12 mm	8,000 lbs	7.0 lbs	1.39
	5/8"	16 mm	12,400 lbs	10.3 lbs	1.69

**ENDURA BRAID EURO LINE**

Specially engineered 12 Strand Dyneema SK 78 core with Marine-Tech coating and the sport's best 24 carrier braided polyester cover.

**Features:** • Excellent strength-to-size ratio • Ultra low elongation • Excellent wet/dry strength retention

**Applications:** • Sheets • Halyards • Guys • Topping lifts • Reef lines • Low-stretch control lines

**Colors Available:** • Blue • Red • Green • Yellow • Gray/White

Item	Size	Size	Average Tensile Strength	Weight lbs/100'	Net/Ft
607768	6 mm	1/4"	4,500 lbs	1.0 lbs	\$1.49
601394	8 mm	5/16"	8,100 lbs	3.0 lbs	1.99
601399	10 mm	3/8"	10,200 lbs	4.5 lbs	2.99
601400	11 mm	7/16"	14,900 lbs	5.4 lbs	3.70

**BRAIDED POLYESTER CORDS**

Utility Cord Lightly braided polyester low-stretch cord that's great for flag halyards, foredeck netting or light-air spinnaker sheets.

**Applications:** • Flag halyards • Tie-downs • Mark anchor lines

**Colors Available:** • White • Black

Item	Size	Size	Average Tensile Strength	Weight lbs/100'	Net/Ft
609015	1/8"	3 mm	580 lbs	0.5 lbs	\$0.10

**POLYESTER HANKS**

A low-stretch cord that's great for flag halyards, foredeck netting, light-air spinnaker sheets, flag halyards, tie-downs and mark anchor lines

**Colors Available:** • White

Item	Size	Size	Average Tensile Strength	Ship	Net
003451POL185	1/8" x 50'	3 mm	580 lbs	1 lbs	\$4.99
003451POL535	5/32" x 50'	4 mm	790 lbs	1 lbs	5.99

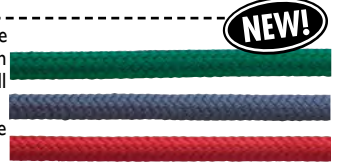



## Samson XLS3

Cruising sailors who desire optimal performance will appreciate the low-stretch polyester construction, smooth rendering, and long life of the cover over a polyester core.

**Material:** Polyester Core/Polyester Cover

**Features & Benefits:**

- Construction: Double braid
- Splice/Class: Double Braid Class I
- Material: Polyester core / Polyester cover
- Excellent abrasion resistance
- Low stretch polyester construction
- Smooth rendering
- Easy to splice

**Applications:**

- Cruising
- Weekend Racing

**Please Specify Color:** White with Blue, Green, Red or Yellow Tracer



**NEW!**



## Samson AS-78® (Amsteel Blue)

AS-78, a 12-strand single braid, is one of the most advanced ropes available on the market today. This rope yields the maximum in strength-to-weight ratio and is stronger than wire rope constructions, but it is lightweight and floats. With superior flex fatigue and wear resistance, Samson's AS-78 is designed for improved service life in applications where creep results from long-term static loads. It offers the yacht-racing community the next generation of Amsteel in high-performance lines for the highest levels of racing.

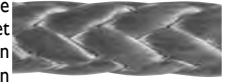

**Features:**

- Stronger than wire
- Lightweight
- Samthane coated
- Similar elongation as wire
- Abrasion resistant
- Easily spliced
- Torque free

**Applications:**

- Control line
- Halyard
- Spinnaker sheet
- Tug line
- General working line/vessel mooring
- Jib/Genoa sheet
- Trawl or bridle line
- Mainsheet
- Winch line

**New Blue Color!**

**Color:** Silver/Gray or Blue

Item	Size	Size	Approximate Strength	Weight lbs/100'	Net/Ft.
013068	1/4"	6 mm	2400 lbs	2.1 lbs	\$0.35
013069	5/16"	8 mm	4000 lbs	3.5 lbs	0.55
013070	13/32"	10 mm	5800 lbs	5.2 lbs	0.70
013071	1/2"	12 mm	8100 lbs	7.2 lbs	1.00

## Samson MLX3

MLX3 is a lightweight, core-dependent line that has excellent strength and moderate stretch. The core is coated to match the cover, making the line strippable for greater savings.

**Material:** HMPE-Blended Core with Polyester Cover

**Features & Benefits:**

- Construction: Core-dependent Double Braid
- Fiber: HMPE-blended Core / Polyester Cover
- Splice/Class: Double Braid Class II
- Can be tapered
- High Strength
- Lightweight
- Moderate stretch
- Coated core matches the cover

**Applications:**

- Performance Cruising
- Auxiliary Lines - Racing

**Please Specify Color:** Gray with Blue, Green, Red or Yellow Tracer



**NEW!**

Item	Size	Size	Approximate Strength	Weight lbs/100'	Net/Ft.
013072	1/4"	6 mm	3400 lbs	2.1 lbs	\$0.60
013073	5/16"	8 mm	5600 lbs	3.4 lbs	1.00
013074	13/32"	10 mm	7700 lbs	4.7 lbs	1.30
013075	1/2"	12 mm	10900 lbs	6.3 lbs	1.75

## Samson MFP Floatline

Double braid with a multifilament polypropylene cover and floating core

**Applications:**

- Accessory products
- Halter/headgear
- Dinghy tow lines
- Floating mooring lines

**Color:** Yellow with Red fleck



Item	Size	Size mm	Tensile lbs	Weight lbs/100'	Net/Ft
013053	3/8"	9	3,200	2.7 lbs	\$0.54
013054	1/2"	12	5,200	4.5 lbs	0.84
013055	5/8"	16	7,400	8.0 lbs	1.49

## Samson Solid Braid Polyester

An extremely lightweight general-purpose line that stays round and firm.

**Features:**

- High flexibility
- Shock absorbent
- Remains soft
- Resists rot, mold and mildew
- Resists UV degradation and most chemicals

**Specifications:**

- Line Diameter: 1/8" (3 mm)
- Material: polyester
- Average Tensile Strength: 310 lbs
- Line Length: 50' Hank
- Color: White

Item	Dia.	Average Strength	Length	Ship	Net
011806	1/8"	310 lbs	50' hank	1 lbs	\$4.99

**FOR SAMSON DOCK AND ANCHOR LINES PLEASE SEE PAGE 43**

## Samson Trophy™ Braid

Trophy Braid is excellent for cruising sailors who want a rope with a soft hand.

**Material:** Spun Polyester Cover/Polyester Core

**Features:**

- Soft, fuzzy cover
- Holds well in all types of cleats
- Easy-to-hold, wet or dry
- Solid grip on winch drums.

**Applications:**

- Mainsheet
- Spinnaker sheet
- Jib/Genoa sheet
- Control line

**Please specify color:** White with Red and Green I.D., solid Color with ID: Green, Red, Blue or Black

Dia.	Size mm	Approx. Strength	Approx. Ship Weight/100'	White with I.D.	Net/Foot	Color With I.D.	Net/Foot
3/16"*	5	800 lbs	2 lbs	002440	\$0.29	012153	\$0.34
1/4"	6	1,400 lbs	2 lbs	002439	0.49	002491	0.55
5/16"	8	2,000 lbs	3 lbs	002430	0.65	002431	0.69
3/8"	9	3,000 lbs	4 lbs	002357	0.85	002356	0.89
7/16"	11	4,000 lbs	6 lbs	002362	1.06	002360	1.15
1/2"	12	6,000 lbs	7 lbs	002334	1.35		

## Samson Lash-It

- A sailor's duct tape
- Stronger than steel, floats and will not absorb water
- Single braid made from Dyneema® fiber with Samthane coating
- Can be used for lashing down covers and hardware to rails
- 180' per spool
- Color: Gray

Item	Dia.	Average Strength	Ship	Net
615077	1/16"	500 lbs	1 lbs	\$32.99



## Mini Braid Accessory Cords - 300 FT SPOOL

A torque-free, smooth-running general purpose line.

**Features:**

- Excellent strength and knotting properties
- High flexibility
- Abrasion resistant
- Low stretch
- Available in solid color Black

Item	002611	002612	002613	002614	002615	002616	002617	002618
Diameter	2 mm	3 mm	4 mm	5 mm	6 mm	7 mm	8 mm	9 mm
Avg. Strength	230 lbs	600 lbs	1,000 lbs	1,200 lbs	2,200 lbs	2,800 lbs	3,500 lbs	4,300 lbs
Ship/Spool	2 lbs	2 lbs	4 lbs	4 lbs	6 lbs	8 lbs	12 lbs	15 lbs
Net/Spool	\$42.99	52.99	62.99	88.99	124.99	148.99	179.99	194.99

## DEFENDER'S RIGGING SHOP

email: [rigging@defender.com](mailto:rigging@defender.com)

Defender offers four different types of rigging service: standing rigging, rope/chain rodes, eye splices and lifelines. For more information please visit [www.defender.com/rigging\\_form.jsp](http://www.defender.com/rigging_form.jsp)

## Cordage, Line & Halyards



### ARGUS HALYARDS

For Club Racers and Performance Cruisers

- Spectra/MFP UV stabilized and color coded core
- Lightweight and its 16 Carrier high tenacity marine coated polyester cover grips well in rope clutches
- Modern "Mottled" color pattern
- Lower elongation and lighter than polyester double braid



**ARGUS Pre Spliced Main Halyards** feature

Spliced stainless steel captive pin headboard shackle, "messenger tail" whipped end  
Please Specify: Blue/Silver or Black/Silver

Item	Size	mm	Ship	Net	Item	Size	mm	Ship	Net
608082	5/16" x 70'	8	3 lbs	\$119.99	608084	7/16" x 120'	11	7 lbs	\$209.99
608083	3/8" x 100'	10	5 lbs	189.99	608085	1/2" x 150'	12	11 lbs	329.99

**ARGUS Pre Spliced Jib/Spinnaker Halyards** feature a stainless steel snap swivel spliced to one end with a messenger tail and whipped end

Please Specify: Red/Silver, Blue/Silver, and Green/Silver

Item	Size	mm	Ship	Net	Item	Size	mm	Ship	Net
608045	5/16" x 80'	8	3 lbs	\$124.99	608047	7/16" x 110'	11	7 lbs	\$234.99
608046	3/8" x 90'	10	4 lbs	189.99	608048	1/2" x 160'	12	12 lbs	349.99

### PRE-SPICED POLYESTER MAIN HALYARDS

Made with XLE low stretch polyester line. Spliced with a stainless steel headboard shackle with captive key pin at one end and whipped with a messenger tail at the other end. Ideal for Mainsails. **Specify:** White with Blue fleck or Traditional Tan.

Item	Size	mm	Ship	Net
615318	5/16" x 60'	8 mm	3 lbs	\$74.99
615319	3/8" x 90'	10 mm	5 lbs	104.99
615320	7/16" x 110'	11 mm	7 lbs	134.99
615321	1/2" x 140'	12 mm	12 lbs	219.99



### PRE-SPICED POLYESTER JIB AND SPINNAKER HALYARDS

Made with XLE low stretch polyester double braid line. Stainless steel swivel snap shackle at one end and whipped with a messenger tail at the other. **Available in:** Blue w/White fleck, White w/Red or Green fleck and Traditional Tan.

Item	Size	mm	Ship	Net
601151	5/16" x 80'	8 mm	3 lbs	\$95.99
615586	3/8" x 90'	10 mm	6 lbs	109.99
601153	7/16" x 100'	11 mm	7 lbs	164.99
601154	1/2" x 150'	12 mm	12 lbs	229.99



### TRADITIONAL TAN XLE DOUBLE BRAID LINE

- 100% polyester double braid. XLE is made from the highest quality polyester yarns with marine finish on both core and cover
- Balanced core to cover construction ensures that XLE will remain easy to handle and splice while offering maximum abrasion resistance
- Color fast cover yarns are Firebrite 2000 polyester
- Ideal for most running rigging applications on traditional boats

Color: Traditional Tan **Maximum continuous length: 600'**

Item	Dia.	Size	Average Tensile Strength	Approx. Ship Weight /100'	Net per ft
608838	3/16"	5 mm	830 lbs	2 lbs	\$0.29
	1/4"	6 mm	1950 lbs	3 lbs	0.45
	5/16"	8 mm	3500 lbs	4 lbs	0.54
	3/8"	10 mm	4900 lbs	5 lbs	0.75
	7/16"	11 mm	6200 lbs	7 lbs	0.92
	1/2"	12 mm	8500 lbs	9 lbs	1.29

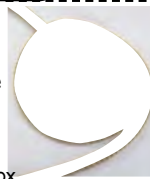

## Defender Splicing Services

SPECIALTY WORK AVAILABLE...PLEASE CALL FOR A QUOTE OR E-MAIL ORDERS@DEFENDER.COM



Item	Description	Net
850026	3-Strand Eye Splice through 9/16"	\$19.00
850027	3-Strand Eye Splice 5/8" through 3/4"	21.00
850130	3-Strand Eye Splice 7/8" through 1"	23.00
850028	Chain to 3 Strand Rode Splice to 3/4"	33.00
850144	8 Plait Eye Splice • Up to 9/16" line	20.00
850145	8 Plait Eye Splice • 5/8"-1" line	24.00
850146	Chain to 8 Plait (Brait) Splice	33.00

### FLEXDEL WATER BASED ROPE DIP / COATING

Flexdel WB546 Series coatings are water based treatments for various types of nets and ropes. • High resistance to abrasion

- Easy to apply • Protection from the elements, including UV rays
- Increases and maintains net strength and knot holding ability

• **Please specify color:** Black, Blue, Clear, Holding, Orange, Red, Yellow, Green

Item	Container	Size	Ship	Net
002916	Pint		2 lbs	\$22.99

Defender uses this product (Blue) on our Defender chain rodes where the line is spliced onto the chain.

## US RIGGING WIRE TO ROPE HALYARDS

7 x 19 Stainless steel wire spliced to Dacron double braid. Comes with thimble and nicopress sleeve. For installation by the yachtsman. **Line Color:** White with Black tracer.



Item	Model	Size	Wire	Line	Line Size	Ship	Net
612191	H-430-1030	1/8" - 7 x 19	30'	30'	5/16"	3 lbs	\$96.99
612192	H-440-1240	1/8" - 7 x 19	40'	40'	3/8"	5 lbs	119.99
612193	H-540-1250	5/32" - 7 x 19	40'	50'	3/8"	5 lbs	141.99
612194	H-650-1450	3/16" - 7 x 19	50'	50'	7/16"	8 lbs	154.99
612195	H-765-1665	7/32" - 7 x 19	65'	65'	1/2"	11 lbs	239.99

## NEW ENGLAND ROPES VPC PERFORMANCE BRAID PRESPLICED JIB HALYARD

**NEW!**



- Designed with the casual racer or offshore cruiser in mind
- Includes Wichard snap shackle
- Features reeving eye to make running new halyard through the mast easier.

Item	Size	Color	Ship	Net
615566	8mm (5/16") x 60'	Blue	3 lbs	\$154.99
	8mm (5/16") x 60'	Red	3 lbs	154.99
	10mm (3/8") x 90'	Blue	5 lbs	219.99
	10mm (3/8") x 90'	Red	5 lbs	219.99
	11mm (7/16") x 110'	Blue	7 lbs	319.99
	11mm (7/16") x 110'	Red	7 lbs	319.99

## NEW ENGLAND ROPES VPC PERFORMANCE BRAID PRESPLICED MAIN HALYARD

**NEW!**



- Designed with the casual racer or offshore cruiser in mind
- Includes Wichard captive pin shackle
- Features reeving eye to make running new halyard through the mast easier.

Item	Size	Color	Ship	Net
615567	8mm (5/16") x 60'	Green	3 lbs	\$139.99
	10mm (3/8") x 90'	Green	5 lbs	199.99
	11mm (7/16") x 110'	Green	7 lbs	299.99

## buccaneer rope company

### POLYESTER DOUBLE BRAID TOPPING LIFT

- Offers the low stretch and high strength-to-weight qualities required for modern sailing
- Includes 1" spliced eye and whipped bitter end (shackle not included)
- Color: White with Red/Yellow Tracer

Item	Model	Dia.	Length	Tensile Strength	Ship	Net
607409	403-10-02-80	5/16"	80'	3000 lbs	3 lbs	\$39.99
607410	403-12-02-95	3/8"	95'	4200 lbs	4 lbs	47.99



Item	Description	Net
850029	Double Eye Splice 1/4" through 7/16"	\$19.00
850030	Double Eye Splice 1/2" through 5/8"	21.00
850127	Double Eye Splice 3/4" through 1"	25.00
850031	Core-to-Core Eye Splice 1/4" through 3/8"	26.00
850032	Core-to-Core Eye Splice 7/16" through 9/16"	30.00
850033	12-Strand Eye Splice	24.00
850034	End-to-End continuous for roller furling; line diameters up to 1/2"	30.00
850104	Reeving eye for messenger	9.00
850037	Whipping, all lines	6.00

**Double Braid** applies to XLS3, Trophy, Super Strong, MFP line, Sta-set and XLE  
**Core-to-Core (core dependent)** applies to MLX3, Endura and VPC lines.  
**12-Strand** applies to AS-78 line and Regatta Braid.

For Eye Splices, please specify size of eye and item number of hardware to be spliced.



# New & Retrofit Custom Rigging

Defender's Rigging Shop can duplicate your rigging with high quality wire and terminals.



- Call us at 800-628-8225 or e-mail rigging@defender.com for a quote number
- Ship your rigging directly to the rigging shop
  - Please include all of the hardware to be replaced including turnbuckles and toggles
  - Turnbuckles should be taped above and below the barrel to indicate their setting on the tuned mast

Defender Rigging is manufactured in the U.S. by one of the largest riggers in the country, using only the highest quality materials. The following guidelines are a rough estimate of typical standing rigging replacement. Complete our standing rigging measurement form at [defender.com/rigging\\_form.jsp](http://defender.com/rigging_form.jsp) for a detailed estimate based on your specific needs.

Boat	Spreaders	Wire Dia.	Notes	Estimated Price
20-23'	1	1/8"	Full standing rigging package including Forestay ①, Backstay ② (no split), Uppers ③, Forward lowers ⑤	\$399.00
24-28'	1	5/32 & 3/16	Full standing rigging package including Forestay ①, Backstay ② with split ⑦, Uppers ③, Intermediates ④, Forward lowers ⑤ and Aft lowers ⑥. Includes new open-body chrome/bronze turnbuckles	1429.00
29-32'	1	3/16" & 1/4"	Full standing rigging package including Forestay ①, Backstay ② Backstay splits ⑦, Uppers ③, Forward lowers ⑤, Aft lowers ⑥ and Bobstay (not shown). Includes new open-body chrome/bronze turnbuckles	1999.00
33-36'	2	9/32" & 5/16"	Full standing rigging package including Forestay ①, Backstay ② Backstay splits ⑦, Uppers ③, Forward lowers ⑤, and Aft lowers ⑥. Includes new open-body chrome/bronze turnbuckles	4100.00
38-44'	2	5/16" & 3/8"	Full standing rigging package including Forestay ①, Backstay ②, Backstay splits ⑦, Uppers ③, Intermediates ④, Forward lowers ⑤ and Aft lowers ⑥. Includes new open-body chrome/bronze turnbuckles	5600.00
45-48'	2	3/8" & 7/16"	Full standing rigging package including Forestay ①, Backstay ② Backstay splits ⑦, Uppers ③, Intermediates ④, Forward lowers ⑤ and Aft lowers ⑥. Includes new open-body chrome/bronze turnbuckles	7800.00

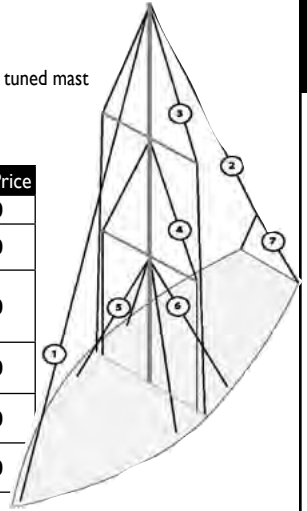

## Sta-Lok Hardware

### STA-LOK EYE TERMINALS

Item	Sta-Lok Number	Wire Size"	Pin Size"	A"	B"	C"	D"	Net
608943	133-04	5/32	5/16	51/64	37/64	5/16	15/64	\$29.99
	133-05	3/16	3/8	1-1/64	45/64	13/32	19/64	34.99
	133-55-3/8	7/32	3/8	1-17/64	15/16	7/16	3/8	46.99
	133-55	7/32	7/16	1-7/32	29/32	15/32	3/8	46.99
	133-55-1/2	7/32	1/2	1-7/32	7/8	1/2	3/8	46.99
	133-06-3/8	1/4	3/8	1-17/64	15/16	7/16	3/8	46.99
	133-06-7/16	1/4	7/16	1-1/4	29/32	15/32	3/8	46.99
	133-06	1/4	1/2	1-7/32	7/8	1/2	3/8	46.99
	133-07	9/32	1/2	1-9/32	31/32	17/32	13/32	52.99
	133-08-1/2	5/16	1/2	1-13/32	1-1/16	9/16	15/32	63.99
	133-08-5/8	5/16	5/8	1-13/32	1-1/16	5/8	17/32	83.99
	133-10	3/8	5/8	1-9/16	1-5/32	45/64	17/32	94.99

All Sta-Lok terminals include the wedge and former. For 1 x 19 wires.

### STA-LOK FORK

Item	Sta-Lok Number	Wire Size"	Pin Size"	A"	B"	C"	D"	Net
608944	134-03	1/8	1/4	39/64	25/64	5/16	7/32	\$33.99
	134-04	5/32	1/4	27/32	37/64	23/64	1/4	41.99
	134-05	3/16	5/16	31/32	29/64	5/16	46.99	
	134-55	7/32	7/16	1-3/16	7/8	5/8	7/16	63.99
	134-06	1/4	7/16	1-3/16	7/8	5/8	7/16	63.99
	134-07	9/32	7/16	1-21/64	1	5/8	7/16	75.99
	134-08	5/16	1/2	1-29/64	1-5/64	3/4	35/64	94.99
	134-10	3/8	5/8	1-5/8	1-5/32	57/64	35/64	125.99

All Sta-Lok terminals include the wedge and former. For 1 x 19 wires.

### STA-LOK FORMERS

Item	Sta-Lok Number	Wire Size"	Wire mm	Net Ea.
608945	115-03	1/8	3	\$3.99
	115-04	5/32	4	3.99
	115-05	3/16	5	4.99
	115-06	1/4	6	4.99

## Hayn Hardware

### HAYN HI-MOD SWAGELESS FITTINGS

Item	Model	Wire"	Thread"	Net
608950	14CTS18	1/8	1/4	\$40.99
	14CTS532	5/32	1/4	45.99
	516CTS532	5/32	5/16	45.99
	516CTS316	3/16	5/16	54.99
	38CTS316	3/16	3/8	54.99
	38CTS732	7/32	3/8	54.99
	716CTS732	7/32	7/16	59.99
	38CTS14	1/4	3/8	69.99

### HAYN HI-MOD COMPRESSION EYE

Item	Model	Wire"	Pin"	Net
608951	38CTE14	1/4	1/2	\$70.99
	38CTE14	1/4	3/8	69.99
	716CTE732	7/32	1/2	79.99
	12CTE14	1/4	1/2	95.99

Hi-MOD installation instructions can be found at <http://www.hayn.com/marine/tech/himod/install.html>  
Norseman-Gibb Replacement Cones available at Defender.com

### STA-LOK STUD

Item	Sta-Lok Number	Wire Size"	Thread Size"	A"	B"	Net
608949	136-03-1/8	1/8	1/4	2-7/16	2-3/16	\$37.99
	136-04-1/4	5/32	1/4	2-17/32	2-5/16	32.99
	136-04	5/32	5/16	2-7/16	2-3/16	32.99
	136-05-5/16	3/16	5/16	2-9/16	2-5/16	39.99
	136-05-3/8	3/16	3/8	3-1/16	2-5/8	39.99
	136-05-7/16	3/16	7/16	3-11/32	2-15/16	41.99
	136-55	7/32	3/8	3-5/16	2-5/8	50.99
	136-55-7/16	7/32	7/16	3-21/32	2-15/16	50.99
	136-06-3/8	1/4	3/8	3-5/16	2-5/8	50.99
	136-06-7/16	1/4	7/16	3-21/32	2-15/16	50.99
	136-06	1/4	1/2	3-11/16	3-3/16	50.99
	136-07	9/32	1/2	3-13/16	3-3/16	62.99
	136-08	5/16	1/2	3-7/8	3-3/16	72.99
	136-08-5/8	5/16	5/8	4-11/32	3-3/4	72.99
	136-10	3/8	5/8	4-3/8	3-3/4	103.99

All Sta-Lok terminals include the wedge and former. For 1 x 19 wires.

### STA-LOK SWAGELESS TERMINAL/TERMINAL RIGGING INSULATORS

Item	Sta-Lok Number	Wire Size"	Breaking Load (lbs)	Overall Length"	Overall Dia."	Ship	Net
608947	143-06	1/4	9000	7-1/2	1-3/8	1 lbs	\$164.99
	143-07	9/32	15000	8	1-1/2	2 lbs	189.99
	143-08	5/16	15000	8	1-1/2	2 lbs	199.99
	143-10	3/8	21900	9	1-39/64	2 lbs	269.99

### STA-LOK WEDGE 1X19 WIRE

Item	Sta-Lok Number	Wire Size"	Net Ea.
608948	126-03	1/8	\$5.99
	126-04	5/32	6.99
	138-05	3/16	6.99
	138-55	7/32	7.99

## Rigging Wire, Tools & Fittings

### WICHARD STAINLESS STEEL WIRE GRIPS

Item	Model	Size	Net
607542	7304	3/16"	\$12.99
607543	7306	5/16"	14.99

### U.S. RIGGING OVAL DOUBLE SLEEVES

Item	Model	Wire Size	Net
608927	S-11-002	1/16"	\$0.59
	S-11-003	3/32"	0.94
	S-11-004	1/8"	0.99
	S-11-005	5/32"	1.29

### S & F TOOL POPULAR "SWAGE-IT" TOOL

Item	Model	For Cable Sizes	Wrench	Ship	Net
608716	2	1/16", 3/32", 1/8"	1/2"	1 lbs	\$28.99
608718	3	1/8", 5/32", 3/16", 1/4"	5/8"	4 lbs	59.99

### COOPER WIRE CUTTERS

Item	Model	For wire Sizes	Ship	Net
611988	0690TN	1/4" soft, 3/16" hard	1 lbs	\$47.99

### COOPER TOOL HEAVY DUTY CABLE CUTTERS

Item	Model	Description	Ship	Net
608722	0190MTN	for up to 3/8"	6 lbs	\$249.99
608721	0390MTN	for up to 5/8"	15 lbs	356.99

## Custom Lifelines Made to your specifications at Defender prices!

- **Defender** lifelines are made in the U.S. by the largest rigger in the country
- Top quality and craftsmanship
- The following guidelines are a rough estimate of typical lifeline replacement cost
- Complete our lifeline measurement form on our website for a detailed estimate based on your needs:  
[www.defender.com/html/lifeline.html](http://www.defender.com/html/lifeline.html)



Boat Size	Description	Price
20' - 25'	Port and starboard upper lifeline - 3/16" coated wire - no gate	<b>\$199.00</b>
30' - 35'	Port and starboard upper lifeline - 3/16" coated wire - no gate	<b>229.00</b>
30' - 35'	Port and starboard upper and lower lifelines - 3/16" coated wire - with gates	<b>879.00</b>
40' - 45'	Port and starboard upper lifeline - 3/16" coated wire - no gate	<b>269.00</b>
40' - 45'	Port and starboard upper and lower lifelines - 3/16" coated wire - with gates	<b>1099.00</b>
Any	Additional midship gate up to 36"	<b>129.00</b>
Any	Stern gate up to 8'	<b>79.00</b>

Estimates are based on type 316 3/16" stainless steel lifeline wire coated to 5/16", Johnson hardware with closed body stainless steel turnbuckles, gates with swivel type gate eyes and deluxe over-center pelican hooks. Other wire sizes and uncoated wire available per your specifications. **Note:** Lifelines with no gates have a turnbuckle on one end and a toggle jaw on the other end.

For exact duplication call us for a reference number, then ship your lifelines directly to the rigging shop. For a quote, simply complete the lifeline measurement form online at <http://www.defender.com/html/lifeline.html> or send via fax or mail. Call or e-mail [rigging@defender.com](mailto:rigging@defender.com) with any questions.

### Lifeline Accessories

Item	Model	Style	Wire Size	Ship	Net
612754	HC18	A-gate stops	1/8-7/32"	1 lbs	<b>\$8.99</b>
612755	HC316	A-gate stops	3/16-5/16"	1 lbs	<b>8.99</b>
Item	Model	Style	Tube Size	Ship	Net
752812	14PA	B-pulpit anchor	1"	1 lbs	<b>\$12.99</b>

Note: Other imperial sizes and metric sizes are available by special order.

### Machine Swage Lifeline Fittings

#### HAYN 316 STAINLESS STEEL TOGGLE JAW

Non-adjustable for lifeline termination.

Item	Model	Wire Size	Pin Size	Ship	Net
612814	14TJLL18	1/8"	1/4"	1 lbs	<b>\$12.99</b>
612815	14TJLL316	3/16"	1/4"	1 lbs	<b>13.99</b>
612816	38TJLL14	1/4"	3/8"	1 lbs	<b>19.99</b>

For detailed specs go to [www.defender.com](http://www.defender.com)

#### HAYN GATE EYES

Made of 316 stainless steel.

INTERLOCKING - ELLI SERIES				SINGLE - ELLS SERIES			
Wire Size	Ship	Threaded Type	Net	Swivel Type	Net	Threaded Type	Net
1/8"	1 lbs	612823	\$29.99	612824	\$25.99	612828	\$15.99
3/16"	1 lbs	612826	32.99	612825	29.99	612830	17.99
1/4"	1 lbs	612827	44.99			612832	25.99

For detailed specs go to [www.defender.com](http://www.defender.com)

### Hayn Handy Crimp Lifeline Hardware



This lifeline system can be installed easily on a boat with the Hayn hand crimping tool. Saves time and money. T-316 grade stainless steel. All ship 1 lbs. Note: Tool below (601369).

Item	Model	Style	Wire Size	Net
612737	14TTCLL18	1-Turnbuckle	1/8"	\$29.99
612738	14TTCLL316	1-Turnbuckle	3/16"	30.99
612740	FPHCLL18	2-Pelican hook	1/8"	40.99
612741	FPHCLL316	2-Pelican hook	3/16"	39.99
612743	14ECLLS18	3-Single gate eye	1/8"	20.99
612745	516ECLLS316	3-Single gate eye	3/16"	22.99
612748	14TJCLL18	4-Toggle jaw	1/8"	17.99
612751	14ECLL18	5-Interlocking gate eye	1/8"	40.99
612752	516ECLL316	5-Interlocking gate eye	3/16"	42.99
608924	14CLLP18LH	6-Short Stud (Left hand)	1/8"	10.99
	14CLL18LH	6-Stud (Left hand)	1/8"	10.99
	14CLL18RH	6-Stud (Right hand)	1/8"	10.99
608925	14CLL316LH	6-Stud (Left hand)	3/16"	11.99
	14CLL316RH	6-Stud (Right hand)	3/16"	11.99
	14CLLP316LH	6-Short Stud (Left hand)	3/16"	11.99
	14CLLP316RH	6-Short Stud (Right hand)	3/16"	11.99
601369	HCTOOL	Handy crimp tool	7 lbs	419.99

### Rigging Wire

#### 1X19 SS TYPE 316 RIGGING WIRE

Stainless steel rigging wire. Sold by the foot.

Break					Break				
Item	Size	Strength	Ship/100'	Net/ft	Item	Size	Strength	Ship/100'	Net/ft
608954	1/8"	2100 lbs	4 lbs	<b>\$0.99</b>		9/32"	10300 lbs	17 lbs	<b>\$2.79</b>
	5/32"	3300 lbs	6 lbs	<b>1.09</b>		5/16"	12500 lbs	21 lbs	<b>3.59</b>
	3/16"	4700 lbs	8 lbs	<b>1.39</b>		3/8"	17500 lbs	30 lbs	<b>3.99</b>
	7/32"	6300 lbs	11 lbs	<b>1.69</b>		7/16"	22500 lbs	41 lbs	<b>4.09</b>
	1/4"	8200 lbs	14 lbs	<b>2.29</b>					

#### 7 X 19 WIRE ROPE

The most flexible cable we offer, 7 x 19 strand should be used for all "running" rigging applications. A few examples are halyards, sheets, outhauls, etc. Type 316 stainless steel.

Break					Break				
Item	Size	Strength	Ship/100'	Net/ft	Item	Size	Strength	Ship/100'	Net/ft
608955	3/32"	920 lbs	2 lbs	<b>\$0.89</b>		1/4"	6400 lbs	14 lbs	<b>\$2.39</b>
	1/8"	1760 lbs	4 lbs	<b>1.09</b>		5/16"	9000 lbs	21 lbs	<b>3.39</b>
	5/32"	2400 lbs	6 lbs	<b>1.29</b>		3/8"	12000 lbs	30 lbs	<b>3.69</b>
	3/16"	3700 lbs	7 lbs	<b>1.69</b>					

#### 7 X 7 WIRE ROPE

Although lower in strength than 1 x 19, cable made of 7 x 7 construction offers considerably more flexibility. Applications include lanyards, luffwire, pennants, etc. Type 316 stainless steel.

Break					Break				
Item	Size	Strength	Ship/100'	Net/ft	Item	Size	Strength	Ship/100'	Net/ft
608952	1/16"	480 lbs	1 lbs	<b>\$0.59</b>		1/8"	1700 lbs	3 lbs	<b>\$0.99</b>
	3/32"	920 lbs	2 lbs	<b>0.69</b>		3/16"	3700 lbs	7 lbs	<b>1.59</b>

#### 7 X 7 WHITE VINYL COATED LIFELINE WIRE

White vinyl coated 7 x 7 lifeline wire is generally used for lifelines, lanyards and topping lifts. This cable can take some bending.

Item	Wire Type	Dia. of Cable	Dia. of Cable	Breaking Strength	Ship/100'	Net/ft
608953	316 SS	1/16"	1/8"	480 lbs	2 lbs	<b>\$0.49</b>
	316 SS	1/8"	7/32"	1700 lbs	5 lbs	<b>0.99</b>
	316 SS	3/16"	5/16"	3700 lbs	10 lbs	<b>1.79</b>
	316 SS	1/4"	3/8"	6100 lbs	15 lbs	<b>2.49</b>

#### PERIMETER LIFELINE CUSHIONS (2 PACK)

These tubular cushions provide a comfortable, yet sturdy backrest. Simply thread your lifeline through the center of these polyester-covered foam cushions.

Item	Model	Length	Color	Ship	Net
612253	LC150.30	3'	White	1 lbs	<b>\$35.99</b>
612254	LC150.45	4.5'	White	2 lbs	<b>42.99</b>
612255	LC150.60	6'	White	2 lbs	<b>49.99</b>



❖ For more detailed product specifications and our complete selection visit [www.defender.com](http://www.defender.com) or call 800-628-8225. ❖





**Suncor DIY Lifeline Kits**

The Quick Attach fittings are completely reusable so all you have to do is replace the wire every few years. Wire replacement is at the discretion of the owner.



**SUNCOR LIFELINE KIT WITH GATE**

The 316 stainless steel, closed body turnbuckles are designed for use with 3/16" wire rope. Kit includes: (1) Quick Attach gate eye, (1) Quick Attach joined gate eye, (2) Quick Attach closed body turnbuckles with toggles, (1) Quick Attach pelican hook.

Item	Model	Description	Ship	Net
606420	C0747-LK01-X	Quick Attach lifeline kit with gate	4 lbs	\$201.99

**SUNCOR LIFELINE KIT - WITHOUT GATE**

The 316 stainless steel closed body turnbuckle is designed for use with 3/16" wire rope. Kit includes: (1) Quick Attach toggle, (1) Quick Attach closed body turnbuckle with toggle.

Item	Model	Description	Ship	Net
606421	C0747-LK03-X	Quick Attach lifeline kit without gate	2 lbs	\$90.99

**STAINLESS WIRE ROPE - GRADE 316**

Use with Quick Attach lifeline kits.  
• Wire: White PVC coated wire • 7 x 7 PVC coated wire is right hand lay

Item	Model	Wire	PVC	Length	Ship	Net
608531	S0708-0508	3/16"	5/16"	30'	3 lbs	\$42.99
		3/16"	5/16"	40'	4 lbs	57.99
		3/16"	5/16"	50'	5 lbs	71.99

**SUNCOR QUICK ATTACH LIFELINE HARDWARE**

All ship 1 lbs.

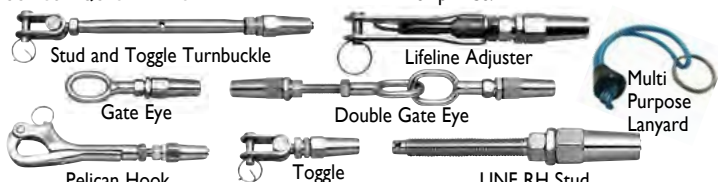

Stainless steel mechanical swage fittings are designed so that the wedges are on the outside of the cable making assembly much easier allowing for different types of wire to be used with the same fitting.

Item	Model	Description	Wire Size	Thread	Net
600902	S0764-0703	Stud and toggle turnbuckle	1/8"	1/4"	\$31.99
600890	S0764-0905	Stud and toggle turnbuckle	3/16"	5/16"	43.99
600892	S0771-0703	UNF right hand stud	1/8"	1/4"	21.99
600893	S0771-090-5	UNF right hand stud	3/16"	5/16"	28.99
600897	S0776-190-5	Gate eye, 5.35" long	3/16"	-	37.99
600898	S0776-290-5	Double gate eye, 9.1" long	3/16"	-	68.99
600899	S0778-0703	Quick Attach toggle	1/8"	-	26.99
600900	S0778-0905	Quick Attach toggle	3/16"	-	38.99
600905	S0162-QA07	Quick Attach pelican hook	1/8"	1/4"	29.99
600901	S0162-QA08	Quick Attach pelican hook	3/16"	5/16"	42.99
600891	S0767-090-5	Quick Attach lifeline adjuster	3/16"	-	36.99
600907	P0760-W005	Wedge kit for all 3/16" Quick Attach parts			16.99
603588	S0157-T000	Multi-purpose lanyard			0.99

**SUNCOR HEAVY-DUTY LIFELINE SYSTEMS**

1" double lifeline stanchion uses 3/16" wire.

System components are all 316 stainless steel.

Item	Model	Description	Ship	Net
600826	S3610-0000	Base W 1.78" x L 2.37"	2 lbs	\$37.99
600922	S3609-2425	Stanchion 24" high	2 lbs	63.99
600827	S3609-3025	Stanchion 30" high	2 lbs	66.99
600887	S3610-0600	Brace, fits 24" stanchion	2 lbs	42.99
600888	S3610-0750	Brace, fits 30" stanchion	2 lbs	44.99

**BRAIDED LANYARDS**

All ship 1 lbs.

Item	Description	Starting At
608302	Braided Lanyard - Select Size	\$1.29

**SCHAEFER DOUBLE STANCHION AND BASE**

• Stainless steel base canted 5° inboard to match most deck chambers  
• Features a 5/16" welded rod reinforcement which also serves as a bail for snatch blocks and other gear • Uses 1/4" fasteners



Item	Model	Dimensions	Ship	Net
615142	36-01	5-1/8" L x 2-3/4" W for 1" tube	1 lbs	\$93.99
602812	36-18	1" x 24" L Double Stanchion	2 lbs	105.99

More stanchion hardware at [www.Defender.com](http://www.Defender.com)

**NEW ENGLAND ROPE STS - WR2 WIRE ROPE**

All ship 1 lbs.

Comprised of 100% Dyneema SK78, this double braid is the perfect wire rope replacement. Ideal for lifelines. • Lighter, more flexible and has a much longer service life than wire • Little degradation from sunlight • Specify: Gray or White

Item	Diameter	Strength	Net/ft	Item	Diameter	Strength	Net/ft
604421	3 mm (1/8")	1800 lbs	\$1.05	604422	5 mm (3/16")	4000 lbs	\$1.79
606808	4 mm (5/32")	3670 lbs	1.37	606809	7 mm (9/32")	7400 lbs	2.11

**C.S. JOHNSON SPLICE LINE LIFELINE KIT**

Application: Upper or lower lifeline for sail or power boats up to 40'. Kit includes: (2) toggle jaws, (2) turnbuckles, fid, needle and splicing instructions.

- (2) LS-3600
- Body diameter is 9/16"
- (2) LS-2900 turnbuckles (tubular)
- Whipping twine
- SWL: 1200 lbs
- Splicing instructions
- 6 mm Gray Dyneema line
- Installation instructions

Item	Model	Boat size	Line	Ship	Net
615388	SLK-30	Up to 30'	70', 1/4"	3 lbs	\$249.99
615389	SLK-40	Up to 40'	90', 1/4"	3 lbs	279.99



**C.S. JOHNSON SPLICE LINE LIFELINE GATE KITS**

All ship 1 lbs  
**Midship Kit Includes:** (1) LS-3100 over center pelican hook, (1) LS-3300 eye to splice connector, (1) LS-3400 adjuster, (1) LS-3200 splice to splice connector, instructions and 6' of 1/4", (6 mm) Gray Dyneema line

**Aft Kit Includes:** (1) LS-3100 over center pelican hook, (1) LS-3300 eye to splice connector, instructions, 6' of 1/4" (6 mm) Gray Dyneema line

Item	Model	Application	Net
615390	SLK-GKM	Midship, one side only	\$134.99
615391	SLK-GKA	Aft, one side only	79.99

**C.S. JOHNSON SPLICE LINE END FITTINGS**

All ship 1 lbs.  
These splice line fittings are machined out of 6061-T6 aluminum and then hard anodized. Recommended line diameter is 1/4" Dyneema.

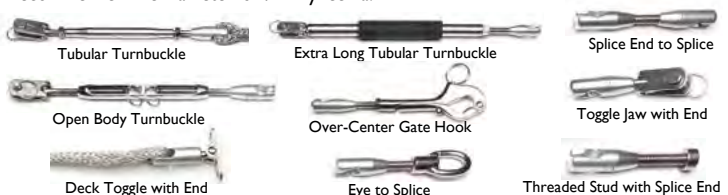

Item	Model	Description	Net
606340	LS-2900	Tubular turnbuckle with splice eye	\$35.99
606341	LS-5200	Open body turnbuckle with splice eye	50.99
606342	LS-92-150	XL tubular turnbuckle with splice eye (Extra length - 19" open)	82.99
606343	LS-3100	Standard over-center gate hook with splice eye (3-1/2")	58.99
606344	LS-3170	Mini over-center gate hook with splice eye, (2-3/4")	48.99
606345	LS-3200	Splice eye to splice eye fitting	30.99
606346	LS-3400	Adjuster with end and splice eye	30.99
606347	LS-3600	Toggle jaw with end and splice eye	19.99
606348	LS-3650	Deck toggle/Terminal with end and splice eye	20.99
606350	20-63	Splice eye w/Threaded stud 5/16"-24 x 2" LH	19.99
615387	LS-3300	Gate eye to splice eye fitting	25.99
606349	Right or Left	Threaded stud with splice end	19.99
606929	20-64	Splice eye w/Threaded stud 5/16"-24 x 2" RH	22.99

**NEW! Johnson Hand Crimp Lifeline fittings now at Defender.com**

**C.S. JOHNSON OVER CENTER SNAP GATE PELICAN HOOK\***

All ship 1 lbs  
• "Over center" design with no load on the swinging hook when closed  
• Adjuster: 1-1/4" Investment cast T-316 stainless steel

Item	Model	Wire	Thread	Net
608712	26-884*	1/8"	1/4" - 28 LH	\$48.99
	27-886*	3/16"	5/16" - 24 LH	55.99
	21-884	1/8"	1/4" - 28 LH	47.99
	21-886	3/16"	5/16" - 24 LH	57.99
	21-885	5/32"	5/16" - 24 LH	58.99
601416	21-850		Gate hook repair kit	13.99

\* Hand Crimp

**C.S. JOHNSON REPLACEMENT SNAP GATE HOOK - BODY ONLY**

All ship 1 lbs  
• Select thread size and direction  
• Material: Cast T-316 stainless steel

Item	Model	Thread	Net
608849	21-80	5/16" - 24 LH	\$47.99
	21-81	1/4" - 28 LH	47.99
	21-80-1	5/16" - 24 LH	47.99
	21-88	8mm x 1.25 RH	49.99

Now stocking Johnson hand crimp fittings at [www.Defender.com](http://www.Defender.com)

**WHITE WATER MARINE LIFELINE SYSTEMS**

All ship 1 lbs  
• Material: 304 stainless steel tubing  
• Sold individually, with double lifeline holes

Item	Model	Description	Net
608804	60155	Cylindrical tip stanchion	\$59.99
608805	60165	Tapered tip stanchion	49.99
608806	60175L	Gate stanchion left	64.99
	60175R	Gate stanchion right	64.99
608807	60185	316 SS cast stanchion base for 1" stanchion	26.99
608808	60205	316 SS cast stanchion base for 1" stanchion - Double baled 3° inboard cant	34.99



## Turnbuckles

### HAYN FBJ SERIES JAW AND BODY ONLY TURNBUCKLE

Highly polished, open body forged bronze turnbuckle and 316 stainless steel left handed "T" toggle end fitting with clevis pin. Features strong, corrosion resistant non-galling construction. Chrome plated body.



Item	Model	Jaw Width &		Open Length	Closed Length	Ship	Net
		Pin size	Thread				
608956	14FBJ	1/4"	1/4"-28"	7-5/8"	6-1/8"	1 lbs	\$25.99
	516FBJ	5/16"	5/16"-24"	8-1/4"	6-5/8"	1 lbs	38.99
	38FBJ	3/8"	3/8"-24"	9-1/8"	7-3/8"	1 lbs	47.99
	12FBJ	1/2"	1/2"-20"	10-15/16"	8-15/16"	2 lbs	75.99
	58FBJ	5/8"	5/8"-18"	13-3/4"	11-1/4"	3 lbs	115.99
	34FBJ	3/4"	3/4"-16"	17-7/16"	14-7/16"	4 lbs	174.99



### HAYN TFBJ SERIES JAW TO JAW TURNBUCKLE

Highly polished, open body forged bronze turnbuckle and 316 stainless steel "T" toggle end fittings with clevis pins. Features strong, corrosion resistant non-galling construction. Chrome plated body.

Item	Model	Jaw Width &		Open Length	Closed Length	Ship	Net
		Pin size	Thread				
608957	14TFBJ	1/4"	1/4"-28"	10-3/4"	7-3/4"	1 lbs	\$32.99
	516TFBJ	5/16"	5/16"-24"	11-7/16"	8-3/16"	1 lbs	51.99
	38TFBJ	3/8"	3/8"-24"	12-11/16"	9-3/16"	1 lbs	64.99
	12TFBJ	1/2"	1/2"-20"	15-7/16"	11-7/16"	2 lbs	98.99
	58TFBJ	5/8"	5/8"-18"	19-5/16"	14-5/16"	3 lbs	165.99
	34TFBJ	3/4"	3/4"-16"	24-13/16"	18-13/16"	7 lbs	282.99

### JOHNSON STAINLESS STEEL TUBULAR TURNBUCKLES

These jaw/jaw turnbuckles are found as standard equipment on many production boats and proudly made in the USA. Features include closed body, stainless steel toggle ends and stainless steel bodies. Manufacturer recommends not exceeding 40% of breaking load.

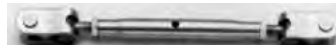

Item	Model	Wire Dia	Breaking Load lbs.	Pin Dia.	Length		Ship	Net
					Length Closed	Length Open		
608958	03-110	To 3/32"	1000	3/16"	6-3/8"	8-7/8"	1 lbs	\$21.99
	04-110	To 5/32"	2500	1/4"	8"	11"	1 lbs	29.99
	05-110	To 3/16"	4000	5/16"	9"	12-3/4"	1 lbs	37.99
	06-110	To 1/4"	7000	3/8"	9-1/2"	13-3/4"	1 lbs	58.99

### JOHNSON POSITIVE LOCK TUBULAR TURNBUCKLES

These jaw/jaw turnbuckles feature a positive locking system which replaces traditional cotter rings or pins. The simple design of the locking mechanism ensures trouble-free use and no more struggling with cotter rings!



Item	Model	Wire Dia	Breaking Load	Pin Dia.	Length		Ship	Net
					Length Closed	Length Open		
608959	04-120	To 5/32"	2500	1/4"	7-3/4"	10-5/8"	1 lbs	\$35.99
	08-110	To 1/4"	7000	3/8"	9-1/4"	12-1/2"	1 lbs	63.99
	09-100	To 5/16"	10,500	1/2"	12"	16-3/4"	2 lbs	144.99
	10-100	To 3/8"	14,800	5/8"	14"	19"	4 lbs	181.99

### JOHNSON SPLIT BACKSTAY ADJUSTER

This adjusting car replaces separate blocks and a connecting member. Tandem sheaves eliminate severe flexing of the backstay providing a neat, thoroughly functional fitting. The 38 series with Delrin sheaves is intended for boats under 30', while the 39 series with aluminum sheaves is intended for boats up to 40'.



Item	Model	Max. Wire	Downhaul Fitting	Ship	Net
	38-202	3/16"	Becket	1 lbs	59.99
	38-203	3/16"	Sheave and becket	1 lbs	59.99
	39-201	1/4"	Sheave	1 lbs	79.99
	39-202	1/4"	Becket	1 lbs	77.99
	39-203	1/4"	Sheave and becket	2 lbs	81.99

### SPINLOCK RIG-SENSE RIG TENSION GAUGE

Measures the loads in wire or rope on dinghies and small keelboats. Applications: Repeatable rig settings. Aids in racing set up and preparation.



Item	608407	RGS/0205	2-5 mm	Ship 1 lbs	Net \$129.99
		RGS/0508	5-8 mm	2 lbs	233.99

Wichard Backstay Adjusters available at [www.defender.com](http://www.defender.com)

### LOOS TENSION GAUGES

Provide an accurate measurement of the tension in rigging wire and other types of wire used in recreational applications. Designed and tested to provide an accuracy of plus or minus 5%.



#### Professional Models (pictured)

Item	Model	Cable Range	Ship	Net
608694	PT-1	3/32", 1/8", 5/32"	1 lbs	\$108.99
608695	PT-2	3/16", 7/32", 1/4"	1 lbs	114.99
608696	PT-3	1/4", 9/32", 5/16", 3/8"	2 lbs	257.99

#### Standard Models

608698	91-Model A	3/32" to 5/32"	1 lbs	\$77.99
608697	90-Model B	3/16" to 9/32"	1 lbs	79.99

## Quick Pins

### QUICK PIN All Ship 1 lbs.

The quick pin is available in sizes ranging from 3/16" to 3/8" to ensure a perfect fit for every project. This pin is made from grade 316 stainless steel for maximum corrosion resistance and durability. It is ideal for marine and industrial rigging applications.



Item	Model	Working Load	A	B	C	D	Net
608961	S0370-0725	4600 lbs	1/4"	1"	1-1/2"	2-1/2"	\$7.99
	S0370-0740	4600 lbs	1/4"	1-1/2"	2"	3"	7.99
	S0370-0750	4600 lbs	1/4"	2"	2-1/2"	3-1/2"	8.99
	S0370-0825	7200 lbs	5/16"	1"	1-1/2"	2-1/2"	8.99
	S0370-0850	7200 lbs	5/16"	2"	2-1/2"	3-1/2"	8.99
	S0370-1025	10300 lbs	3/8"	1"	1-1/2"	2-1/2"	9.99
	S0370-1065	10300 lbs	3/8"	2-1/2"	3"	4"	10.99

### QUICK LOCK PIN All Ship 1 lbs.

The quick lock pin is available in sizes ranging from 3/16" to 3/8" to ensure a perfect fit for every project. This pin is made from grade 316 stainless steel for maximum corrosion resistance and durability. It is ideal for marine and industrial rigging applications.

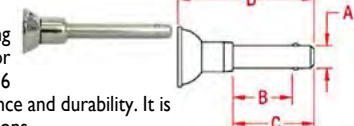

Item	Model	Working Load	A	B	C	D	Net
608962	S0375-0725	4600 lbs	1/4"	1"	1-1/4"	2"	\$13.99
	S0375-0740	4600 lbs	1/4"	1-1/2"	1-3/4"	2-1/2"	18.99
	S0375-0750	4600 lbs	1/4"	2"	2-1/4"	3"	19.99
	S0375-0825	7200 lbs	5/16"	1"	1-1/4"	2"	14.99
	S0375-0850	7200 lbs	5/16"	2"	2-1/4"	3"	20.99
	S0375-1025	10300 lbs	3/8"	1"	1.38"	2.2"	18.99
	S0375-1065	10300 lbs	3/8"	2-1/2"	2.88"	3.70"	22.99

## Rigging Hardware

### HAYN THREADED T-BOLT TOGGLE JAW All Ship 1 lbs.

Complete with pins and rings • 316 stainless steel

Item	Model	Pin	Jaw	Thread	Length	Net
601508	14TJLH-RP	1/4"	1/4"	1/4"-28 LH	2-1/4"	\$9.99
601509	516TJLH-RP	5/16"	5/16"	5/16"-24 LH	2-3/8"	16.99
601510	516TJRH-RP	5/16"	5/16"	5/16"-24 RH	2-3/8"	16.99
601511	38TJLH-RP	3/8"	7/16"	3/8"-24 LH	2-3/4"	20.99

### C.S. JOHNSON STAY EXTENDER All ship 1 lbs.

Designed to extend a short stay or to replace a turnbuckle. Includes (2) pins • Material: T-316 stainless steel

Item	Model	Pin Diameter	Max. Pin to Pin	SWL (lbs)	Ship	Net
611924	16-204	1/4"	3-3/4"	1000	1 lbs	\$14.99
611925	16-205	5/16"	4-3/8"	1600	1 lbs	20.99
611926	16-206	3/8"	5"	2800	1 lbs	26.99
611927	16-208	1/2"	5-5/8"	4200	1 lbs	42.99

### C.S. JOHNSON DOUBLE JAW RIGGING TOGGLE

Facilitates toggling action when used with marine eyes and mechanical fittings. Includes pins • Material: 316 stainless steel. All ship 1 lbs

Item	Model	Pin Dia.	SWL	Net	Item	Model	Pin Dia.	SWL	Net
615570	12-320	1/4"	1000 lbs	\$27.99	12-323	1/2"	4200 lbs	\$62.99	
	12-321	5/16"	1600 lbs	37.99	12-324	5/8"	5900 lbs	92.99	
	12-322	3/8"	2800 lbs	40.99	12-325	3/4"	9000 lbs	111.99	
	12-326	7/16"	3500 lbs	46.99					

### HAYN MARINE EYE TOGGLE JAW All ship 1 lbs.

316 stainless steel • Machine swage only. Comes complete with clevis and cotter pins

Item	Model	Wire Size	Pin Size	Jaw Width	Net	Item	Model	Wire Size	Pin Size	Jaw Width	Net
615049	14RT18	1/8"	1/4"	1/4"	\$12.99	615053	12RT932	9/32"	1/2"	1/2"	\$41.99
615050	516RT532	5/32"	5/16"	5/16"	16.99	615054	58RT516	5/16"	5/8"	5/8"	58.99
615051	38RT316	3/16"	3/8"	3/8"	19.99	615055	58RT38	3/8"	5/8"	5/8"	72.99
615052	12RT14	1/4"	1/2"	1/2"	32.99						

### SUNCOR RIGGING TOGGLES All ship 1 lbs.

Ideal for applications where turnbuckle jaw is misaligned. 316 stainless steel. Removable clevis pin

Item	Model	Size	Jaw Width	Work Load	Net
608963	S0168-SS07	1/4"	.26"	440 lbs	\$8.99
	S0168-SS08	5/16"	.34"	800 lbs	10.99
	S0168-SS10	3/8"	.40"	1200 lbs	15.99
	S0168-SS12	7/16"	.48"	1600 lbs	20.99
	S0168-SS13	1/2"	.56"	2200 lbs	29.99
	S0168-SS16	5/8"	.63"	3500 lbs	31.99

### JOHNSON TOGGLES All ship 1 lbs.

Stainless steel • Essential to prevent misalignment of rigid jaw turnbuckles

Item	Model	Dimensions	Work Load	Net
608964	12-120	1/4" D x 1" L x 1/4" W	1000	\$14.99
	12-121	5/16" D x 1-1/4" L x 5/16" W	1600	19.99
	12-122	3/8" D x 1-5/8" L x 3/8" W	2800	24.99
	12-123	1/2" D x 1-7/8" L x 1/2" W	4200	35.99
	12-124	5/8" D x 2-1/4" L x 5/8" W	5900	56.99



# HTX Blocks

All ship at 1 lbs.

Drawing upon the design of the racing range, the HTX blocks are constructed from a minimal number of alloy parts, providing enhanced reliability. These blocks are ideal for frequently adjusted, highly loaded systems using modern line technology and reduced line diameters, and are suitable for cruising and racing.

- Aluminum cheeks
- High load capacity and large line size
- Side thrust ball bearings
- Head design from Lewmar racing range with swivel head locking mechanism through a grub screw

## 50 MM (3/8" MAX. LINE) All ship at 1 lbs.

Item	Model	Description	SWL (lbs)	Net
615336	29195031	Fiddle	1762	\$70.99
615337	29195034	Fiddle Becket	1762	108.99
615341	29195037	Fiddle Cam	1762	112.99
615342	29195039	Fiddle Becket Cam	1762	150.99

## 50 MM (3/8" MAX. LINE) All ship at 1 lbs.

Item	Model	Description	SWL (lbs)	Net
615331	29195001	Single	1762	\$44.99
615332	29195002	Double	1762	87.99
615333	29195003	Triple	1762	110.99
615334	29195004	Single Becket	1762	60.99
615335	29195005	Double Becket	1762	118.99

## 50 MM (3/8" MAX. LINE) All ship at 1 lbs.

Item	Model	Description	SWL (lbs)	Net
615338	29195021	Toggle Head	1762	\$44.99
615339	29195009	Single Becket Cam	1762	101.99
615340	29195010	Triple Becket Cam	1762	183.99

## 60 MM (1/2" MAX. LINE) All ship at 1 lbs.

Item	Model	Description	SWL (lbs)	Net
615343	29196001	Single	2422	\$49.99
615344	29196002	Double	2422	96.99
615345	29196003	Triple	2422	130.99
615346	29196004	Single Becket	2422	67.99
615347	29196005	Double Becket	2422	116.99

## 60 MM (1/2" MAX. LINE) All ship at 1 lbs.

Item	Model	Description	SWL (lbs)	Net
615350	29196009	Single Becket Cam	2422	\$111.99
615351	29196021	Single Toggle	2422	49.99
615352	29196010	Triple Becket Cam	2422	195.99

## 60 MM (1/2" MAX. LINE) All ship at 1 lbs.

Item	Model	Description	SWL (lbs)	Net
615348	29196031	Fiddle	2422	\$99.99
615349	29196034	Fiddle Becket	2422	126.99
615353	29196039	Fiddle Becket Cam	2422	175.99

## 72 MM (9/16" MAX. LINE) All ship at 1 lbs.

Item	Model	Description	SWL (lbs)	Net
Locking Swivel Head				
603637	29197239	Fiddle Becket Cam	4405	\$324.99
604408	29197201	Single	4405	78.99
604409	29197202	Double	4405	149.99
604410	29197204	Single Becket	4405	145.99
604411	29197221	Toggle	4405	78.99

## 72 MM (9/16" MAX. LINE) All ship at 1 lbs.

Item	Model	Description	SWL (lbs)	Net
604412	29197231	Fiddle	4405	\$186.99
604413	29197234	Fiddle Becket	4405	225.99
604414	29197237	Fiddle Cam	4405	286.99

## 90 MM (5/8" MAX. LINE) All ship at 1 lbs.

Item	Model	Description	SWL (lbs)	Net
604415	29199001	Single	7709	\$228.99
604416	29199004	Single Becket	7709	333.99

## Control Blocks- Color: Black

All 30 and 40 mm control blocks are extremely lightweight with unprecedented load bearing capability. The sheave uses MRT (Metal Replacement Technology) which, combined with the stainless steel central race and balls, deliver the ultimate efficiency and weight advantage. Cheeks use long fibre technology giving exceptional strength and durability. The clever, open design facilitates easy flushing of sand and salt for smooth running and simple maintenance. 3 year warranty.

### 30 MM (5/16" MAX. LINE)

Item	Model	Description	SWL (lbs)	Net
606442	29901360BK	Cheek	440	\$12.99
615654	29901321BK	Single	440	17.99
615655	29901324BK	Single Becket	440	20.99
615656	29901341BK	Single Fixed Head	440	12.99
615657	29901320BK	Single Stand-Up	440	15.99
615658	29901322BK	Double	660	30.99
615659	29901325BK	Double Becket	660	32.99
615660	29901323BK	Triple	1100	45.99
615661	29901326BK	Triple Becket	1100	48.99
615662	29901328BK	Triple Cam*	550	75.99
615663	29901330BK	Triple Becket Cam*	660	74.99

\* SWL of cam is 264 lbs (on both the 30 mm and 40 mm)

### 40 MM (3/8" MAX. LINE)

Item	Model	Description	SWL (lbs)	Net
615642	29901421BK	Single	528	\$24.99
615643	29901424BK	Single Becket	528	19.99
615644	29901441BK	Single Fixed Head	528	20.99
615645	29901420BK	Single Stand-Up	528	26.99
615646	29901428BK	Single Becket Cam*	528	69.99
615647	29901422BK	Double	1056	49.99
615648	29901425BK	Double Becket	1056	52.99
615649	29901423BK	Triple	1584	73.99
615650	29901426BK	Triple Becket	1584	77.99
615651	29901429BK	Triple Cam*	1584	105.99
615652	29901430BK	Triple Becket Cam*	1584	108.99
615653	29901460BK	Cheekblock	528	20.99

## Synchro Cruising Blocks- Color: Black

- Stainless steel straps and glass-fibre reinforced cheeks
- Easy to use, patented shackle post lock

### 50 MM LINE SIZE RANGE (1/4" OPTIMAL & 3/8" MAX)

Item	Model	Description	SWL (lbs)	Net
615601	29925001BK	Single	990	\$16.99
615602	29925021BK	Toggle Head	990	16.99
615603	29925004BK	Single Becket	990	19.99
615604	29925002BK	Double	990	33.99
615605	29925005BK	Double Becket	990	36.99
615606	29925003BK	Triple	990	49.99
615607	29925010BK	Triple Becket Cam*	990	90.99
615608	29925031BK	Fiddle	990	27.99
615609	29925037BK	Fiddle Cam*	990	46.99
615610	29925039BK	Fiddle Becket Cam*	990	49.99

### 60 MM LINE SIZE RANGE (5/16" OPTIMAL & 3/8" MAX)

Item	Model	Description	SWL (lbs)	Net
615611	29926001BK	Single	1760	\$23.99
615612	29926021BK	Toggle Head	1760	21.99
615613	29926004BK	Single Becket	1760	25.99
615614	29926002BK	Double	1760	45.99
615615	29926005BK	Double Becket	1760	48.99
615616	29926003BK	Triple	1760	68.99
615617	29926010BK	Triple Becket Cam*	1760	114.99
615618	29926031BK	Fiddle	1760	32.99
615619	29926034BK	Fiddle Becket	1760	35.99
615620	29926037BK	Fiddle Cam*	1760	69.99
615621	29926039BK	Fiddle Becket Cam*	1760	71.99
615622	29926029BK	Single Alloy Sheave	1760	38.99

\*SWL of the Cam 50 mm--264 lbs, 60 mm--396 lbs, 72 mm--396 lbs

## 72 MM LINE SIZE RANGE (3/8" OPTIMAL & 7/16" MAX)

Item	Model	Description	SWL (lbs)	Net
615623	29927201BK	Single	2420	\$36.99
615624	29927221BK	Toggle Head	2420	34.99
615625	29927204BK	Single Becket	2420	39.99
615626	29927202BK	Double	2420	71.99
615627	29927205BK	Double Becket	2420	74.99
615628	29927203BK	Triple	2420	105.99
615629	29927210BK	Triple Becket Cam*	2420	150.99
615630	29927231BK	Fiddle	2420	49.99
615631	29927234BK	Fiddle Becket	2420	52.99
615632	29927237BK	Fiddle Cam*	2420	90.99
615633	29927239BK	Fiddle Becket Cam*	2420	93.99

## 90 MM LINE SIZE RANGE (1/2" OPTIMAL & 9/16" MAX)

All ship at 2 lbs.

Item	Model	Description	SWL (lbs)	Net
615634	29929001BK	Single	4400	\$82.99
615635	29929021BK	Toggle Head	4400	77.99
615636	29929004BK	Single Becket	4400	93.99
615637	29929002BK	Double	4400	155.99
615638	29929003BK	Triple	4400	227.99
615639	29929031BK	Fiddle	4400	105.99
615640	29929034BK	Fiddle Becket	4400	105.99
615641	29929039BK	Fiddle Becket Cam†	4400	209.99

† 90 MM uses rope clutch, Max line 7/16" —

# LEWMAR®

## HTX Blocks



## Control Blocks



## Synchro Blocks



ALL LEWMAR BLOCKS AVAILABLE  
PLEASE CALL 800-628-8225  
OR VISIT WWW.DEFENDER.COM/LEWMAR



## SNAP SHACKLE ADAPTORS

Item	Model	Designed for	SWL (lbs)	Net
615568	29925040	50 mm Synchro	990	\$24.99
600909	29926040	60 mm Synchro	1760	28.99
615599	29927240	72 mm Synchro	2420	36.99
615667	29929040	90 mm Synchro, or 72 mm HTX	4400	58.99

# HARKEN

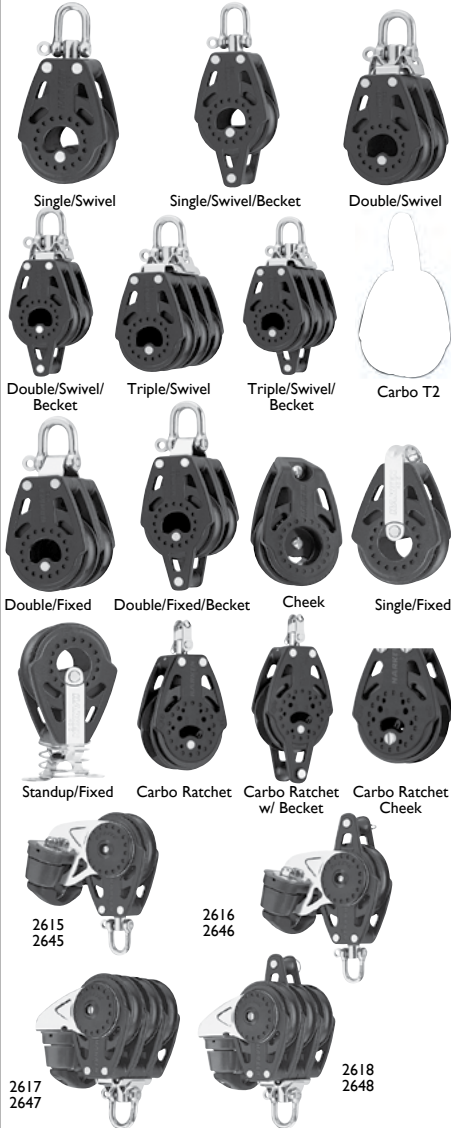

## Antal Low Friction Rings with Dyneema Loops

Antal low friction rings with Dyneema loops are the racers' simple, rugged and lightweight alternative to heavy, complex blocks and shackles. The polished and hard Black anodized aluminum rings provide maximum low friction and flexibility for many running rigging applications.

- Incredibly light, strong, smooth and exceptionally easy to handle
- Antal rings and Dyneema loop assemblies make for a fast and easy connection
- Applications: Lazy jacks, turn buckles, furling line leads, barber hauls, back stay bridles, etc.

Item	Model	Ring Diameter	Loop Length	SWL	Net
608936	RL4.0	10 mm (3/8") 4 mm dyneema + R10.07	70 mm (2.76")	400 kg	\$39.99
	RL4.5	10 mm (3/8") 4.5 mm dyneema + R10.07	80 mm (3.15")	700 kg	41.99
	RL5.0	14 mm (9/16") 5 mm dyneema + R14.10	90 mm (3.54")	900 kg	45.99
	RL6.0	14 mm (9/16") 6 mm dyneema + R14.10	110 mm (4.33")	1500 kg	53.99
	RL6.1	20 mm (3/4") 6 mm dyneema + R20.14	130 mm (5.12")	1500 kg	54.99

## Antal Thin Solid Ring

- The simplest idea for maximum load and minimum weight
- Solid ring has a thinner body than the Antal ring and a wider hole with the same extreme working loads
- Outer groove is suitable for a hanging line
- Minimum friction
- Material: Highly polished, Black hard anodized aluminum body
- Specifically designed for reefing and for 3D setting of the genoa sheet

Item	Model	Size	SWL	Ship	Net
608937	R30.56	30 mm x 56 mm	1800 kg	1 lbs	\$25.99
	R34.64	34 mm x 64 mm	2800 kg	1 lbs	31.99
	R40.76	40 mm x 76 mm	4400 kg	1 lbs	41.99
	R50.94	50 mm x 94 mm	6500 kg	1 lbs	58.99

## 29MM CARBO AIRBLOCKS

All ship at 1 lbs

Use as a mainsheet block on small dinghies or for low-friction control blocks on any size boat. Doubles and triples feature U-lock to hold the swivel in front/side position, or to let it spin freely. The triple's compact cam arm supports high-load purchases of 5:1 or 6:1. The line-shedding cheek block features a small mounting footprint and drainholes.

- Captive ball bearings in sheave for side loads
- Caged torlon roller bearings for high load efficiency and reduced friction
- Three-way head system

Item	Model	Description	Length	MWL	Net
614627	340	Single/swivel	2-5/8"	330	\$22.99
614628	341	Single/swivel/becket	3-11/16"	330	25.99
614629	342	Double/swivel	2-7/8"	660	40.99
614630	343	Double/swivel/becket	3-3/8"	660	44.99
614631	344	Triple/swivel	2-7/8"	990	53.99
614632	345	Triple/swivel/becket	3-3/8"	990	57.99

## 40MM CARBO AIRBLOCKS

All ship at 1 lbs

For jib, mainsheet systems, sheets and control lines on high performance dinghies. Also ideal for highly-loaded control lines on small keelboats. • Sheave diameter: 40 mm • Max line dia.: 3/8" (\*1/4" Max Line dia.) • 5 year warranty

Item	Model	Description	Length	MWL	Net
614029	2636	Single/swivel	3-3/8"	485	\$29.99
614030	2637	Single/swivel/becket	4"	485	33.99
614031	2638	Double/swivel	3-11/16"	970	66.99
614032	2639	Double/swivel/becket	4-5/16"	970	71.99
614033	2640	Triple/swivel	3-11/16"	1455	109.99
614034	2641	Triple/swivel/becket	4-5/16"	1455	114.99
614054	2645	Single/swivel/cam*	3-3/8"	150	95.99
614055	2646	Single/swivel/becket/cam*	4"	300	100.99
614056	2647	Triple/swivel/cam*	3-11/16"	750	168.99
614057	2648	Triple/swivel/becket/cam*	4-5/16"	900	173.99
614035	2642	Double/fixd	3-1/2"	970	55.99
614037	2643	Double/fixd/becket	4-3/16"	970	59.99

## 57MM CARBO BLOCKS

All ship at 1 lbs

Use for main/jib sheets, spinnaker halyard and control lines. Features include the "Cam-Lock" locking system on singles, U-lock for doubles and triples. The cheek attaches easily with three 3/16" screws and is pressed together to prevent the balls from coming out. • Sheave diameter: 57 mm • Max line dia.: 7/16" (\*3/8" Max Line dia.) • 5 year warranty

Item	Model/Description	Length	MWL	Net
614041	2600 Single/swivel*	4-5/16"	792	\$42.99
614047	2604 Triple/swivel*	4-3/4"	2380	130.99
614050	2615 Single/swivel*	4-5/16"	300	120.99
614051	2616 Single/swivel/becket*	5-3/16"	600	125.99
614052	2617 Triple/swivel/cam*	4-3/4"	1500	195.99
614053	2618 Triple/swivel/cam/bkt	5-5/8"	1800	200.99
614048	2605 Triple/swivel/bkt	5-5/8"	2380	135.99
614821	2621 Fiddle	6"	792	51.99
614822	2622 Fiddle/becket	6-7/8"	792	56.99
614823	2623 Fiddle block/cam cleat	6"	793	131.99

## Antal Low Friction Rings

The racers' choice for a simple and lightweight alternative to bulky, complex blocks and heavy fairleads. These polished and hard Black anodized aluminum rings provide maximum low friction and flexibility for many running rigging applications. Sailing applications include lazy jacks, turnbuckles, furling line leads, barber hauls, back stay bridles and more.

Item	Model	Hole Dia x Groove Dia	Ring Height x Outer Width	Weight	SWL	Net
608938	R07.05	7 mm x 5 mm (0.28" x 0.2")	18 mm x 9 mm (0.71" x 0.35")	3 g	400 kg (881 lbs)	\$11.99
	R10.07	10 mm x 7 mm (0.39" x 0.28")	25 mm x 12 mm (0.98" x 0.47")	5 g	800 kg (1,763 lbs)	13.99
	R14.10	14 mm x 10 mm (0.55" x 0.39")	35 mm x 15 mm (1.38" x 0.59")	12 g	1600 kg (3,527 lbs)	14.99
	R20.14	20 mm x 14 mm (0.79" x 0.55")	50 mm x 22 mm (1.97" x 0.8")	44 g	3200 kg (7,054 lbs)	19.99
	R28.20	28 mm x 20 mm (1.1" x 0.79")	70 mm x 31 mm (2.76" x 1.22")	116 g	6400 kg (14,109 lbs)	28.99

## Antal Snap Hook

- Can be easily "hooked" to a genoa or a spinnaker sheet
- The lightest and strongest solution for a line control
- Highly polished, hard Black anodized aluminum
- Has a spliced Dyneema snap loop
- A safety spring prevents the line from going out
- Dyneema loop safety factor (breaking load/safe working load) = 3
- Spare Dyneema loops are available
- Antal offers a special pad-eye for Dyneema loops (Pad eye sold separately)

Item	Model	Max Line Dia.	SWL	Ship	Net
607427	HK12	12 mm	3,300 lbs	1 lbs	\$93.99
607428	HK16	16 mm	4,850 lbs	1 lbs	106.99



**SELDEN 60 MM PLAIN BEARING BLOCKS (PBB 60)**

All ship 1 lbs.

Typically used for heavy and static loads in halyard tuning, mainsheet systems and boom vang. • Stainless steel straps for increased safety • Sliding swivel lock mechanism • Rigid glass fiber reinforced composite cheeks prevent jamming.

Item	Model	Description	SWL (kg)	Net	Item	Model	Description	SWL (kg)	Net
608765	406-001-01	Single*	1000	\$29.99	608774	406-001-10	Triple w/cam and becket**	720	\$128.99
608766	406-001-02	Single w/becket*	1000	33.99	608775	406-001-11	Fiddle*	1000	42.99
608767	406-001-03	Single w/cam**	120	62.99	608776	406-001-12	Fiddle w/becket*	1000	47.99
608768	406-001-04	Single w/cam and becket**	240	65.99	608777	406-001-13	Fiddle w/cam**	360	75.99
608769	406-001-05	Double*	1000	62.99	608778	406-001-14	Fiddle w/cam and becket**	480	79.99
608770	406-001-06	Double w/becket*	1000	65.99	608779	406-001-15	Cheek*	1100	48.99
608771	406-001-07	Triple*	1000	91.99	608780	406-001-16	Curved cheek r345*	1100	48.99
608772	406-001-08	Triple w/becket*	1000	95.99	608781	406-001-17	Curved cheek r48*	1100	48.99
608773	406-001-09	Triple w/cam**	600	124.99	608782	406-001-40	Fiddle w/ twin cams**	120	141.99

\* Max Line Diameter: 14 mm \*\* Max Line Diameter: 12 mm

**SELDEN 80 MM PLAIN BEARING BLOCKS (PBB 80)**

Item	Model	Description	SWL (lbs)	Net
608812	408-001-01	Single*	4400	\$90.99
608813	408-001-02	Single w/becket*	4400	96.99
608814	408-001-11	Fiddle*	4400	132.99
608815	408-001-12	Fiddle w/becket*	4400	140.99
608816	408-001-05	Double*	4400	165.99
608817	408-001-06	Double w/becket*	4400	173.99

\*Max Line Diameter: 16 mm All ship 1 lbs.

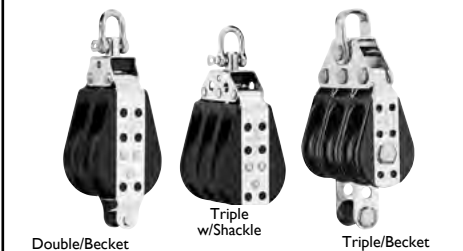

If you don't see a specific Harken or Selden part, email [info@defender.com](mailto:info@defender.com) for a quote.

**HARKEN 75 MM CARBO AIRBLOCKS**



Sheave diameter: 75mm - All ship 1 lbs.

Item	Model	Description	MWL	Net	Item	Model	Description	MWL	Net
600037	2660	Single/swivel	1213	\$74.99	602151	2691	Fiddle/becket	1212	\$98.99
600038	2661	Single/swivel/becket	1213	86.99	602152	2692	Fiddle/swivel/150 cam-matic	900	166.99
600039	2666	Single/swivel/150 cam-matic	300	191.99	602153	2693	Fiddle/swivel/becket/150 cam-matic	1212	176.99
600040	2667	Single/swivel/150 cam-matic becket	600	202.99	602158	2694	Fiddle/ratchet	1212	118.99
600041	2662	Double/swivel	2426	150.99	602159	2695	Fiddle/ratchet/becket	1212	128.99
600042	2663	Double/swivel/becket	2426	161.99	602160	2696	Fiddle/swivel/150 cam-matic	900	197.99
615086	2670	Single/ratchet/swivel	750	79.99	602161	2697	Fiddle/swivel/becket/150 cam-matic	1212	208.99
615087	2671	Single/ratchet/swivel/becket	750	90.99					
602150	2690	Fiddle	1212	89.99					

**HARKEN 29 MM BULLET BLOCKS**

All ship 1 lbs.

Used to lead control lines with a minimum of friction. Dinghies and small keel boats use bullet blocks for vang, out hauls, traveler controls and barber haulers.

• Max line diameter 5/16" • Sheave diameter 1-1/8"

Item	Model	Description	MWL	Net	Item	Model	Description	MWL	Net
604734	082	Single	300	\$14.99	604758	113	Pivoting cheek	300	\$23.99
604735	083	Single w/becket	300	17.99	604740	088	Thru-deck	300	21.99
604821	166	Single w/swivel	300	26.99	604915	287	Thru-deck w/SS cover	300	32.99
604822	167	Single w/swivel becket	300	29.99	604741	089	In-line-exit	400	34.99
604736	084	Double	400	40.99	604917	289	In-line-exit w/SS cover	400	45.99
604737	085	Double w/becket	400	43.99	604842	197	Exit w/cam br. (Port-stbd)	300	88.99
604738	086	Triple	600	56.99	604747	096	Upright lead	300	22.99
604739	087	Triple w/becket	600	59.99	604855	220	Double upright lead	400	39.99

**HARKEN 38 MM BIG BULLET BLOCKS**

All ship 1 lbs.

Ideal for main, jib and spinnaker sheets on small dinghies and for control line applications such as cunninghams, vang, backstays, furling lines and traveler controls on larger boats.

• Max line diameter 3/8" • Sheave diameter 1-1/2"

Item	Model	Description	MWL	Net	Item	Model	Description	MWL	Net
604765	125	Single	300	\$14.99	604768	128	Double w/becket	600	\$71.99
604766	126	Single w/becket	300	30.99	604769	129	Triple w/shackle	750	99.99
604823	168	Single w/swivel	300	35.99	604770	130	Triple w/shackle becket	750	102.99
604824	169	Single w/swivel becket	300	38.99	604771	131	Thru-deck	300	35.99
604796	146	Single w/shackle	300	31.99	604773	134	In-line-exit	600	55.99
604797	147	Single w/shackle becket	300	36.99	604856	222	Upright lead	300	37.99
604767	127	Double w/shackle	600	68.99	604857	223	Double upright lead	600	66.99

**HARKEN 22 MM MICRO BLOCKS**

All ship 1 lbs.

Ball bearing micro blocks meet the need for extremely lightweight, free running blocks. They are ideal for a host of applications on sailboards, smaller dinghies and for lightly loaded control lines on boats of all sizes.

• Max line diameter 1/4"

Item	Model	Description	MWL	Net	Item	Model	Description	MWL	Net
604858	224	Single	200	\$10.99	604864	230	Triple w/471 cam	500	\$88.99
604859	225	Single w/ becket	200	12.99	604863	229	Triple w/ becket	500	41.99
604868	234	Single w/ shackle	200	15.99	604867	233	Cheek	200	15.99
604860	226	Double	350	28.99	604866	232	Traveler	200	24.99
604861	227	Double w/ becket	350	30.99	604876	243	Upright lead	200	15.99
604862	228	Triple	500	40.99					

**HARKEN 60 MM ALUMINUM ELEMENT BLOCKS**



All ship 1 lbs.

Item	Model	Description	MWL	Net	Item	Model	Description	MWL	Net
608970	6260	Single w/ swivel	2425	\$44.99	608977	6267	Single footblock	2425	61.99
608971	6261	Single w/ becket	2425	53.99	608979	6269	Double w/ swivel	3032	105.99
608972	6262	Fiddle	2425	65.99	608980	6270	Double w/ swivel & becket	3032	115.99
608973	6263	Fiddle w/ becket	2425	67.99	608982	6272	Triple w/ swivel	3638	129.99
608974	6264	Fiddle w/ cam & becket	1213	95.99	608983	6273	Triple w/ swivel & becket	3638	145.99
608975	6265	Fiddle w/ swivel & cam	900	85.99	608984	6274	Triple w/ swivel & cam	1499	175.99
608976	6266	Single w/ swivel, becket & cam	600	89.99	608985	6275	Triple w/ swivel, becket & cam	1799	185.99

**HARKEN ACCESSORIES**

All ship 1 lbs.

Item	Model	Description	Net	Item	Model	Description	Net
604727	071	Stand up spring 22 mm	\$1.04	604776	137	Large eye strap 38 mm	\$2.99
604728	072	Small shackle 3/16" pin	4.99	604777	138	Large shackle 1/4" pin	6.99
604909	281	Eye strap, #8 RH fasteners 27 mm	1.80	604843	201	Low profile eye strap 38mm	1.99
604729	073	Eye strap, #10 RH fasteners 32 mm	2.00	604870	237	Bullseye raillead 1" max line dia.	4.99
604748	097	Small stand up spring 19 mm	0.92				

# SCHAEFER LEGENDARY STRENGTH

## Series 7



## Series 8



Visit defender.com for M Series Blocks

## Universal Adapters

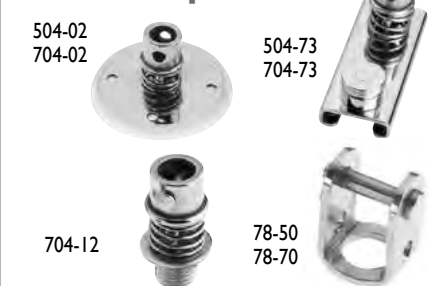

## Sheaves



## Cam Cleats



### SURE GRIP CAM CLEATS All ship 1 lbs

- Stainless steel • Low friction molded bearing surfaces • Uses (2) #10 fasteners

Item	Model	Spacing	Line Size	Fairlead	SWL	Net
603116	70-38	1-25/32"	5/8"	Front	500 lbs	\$88.99
603117	70-39	1-25/32"	5/8"	Top	500 lbs	88.99
603112	70-28	1-1/2"	7/16"	Front	500 lbs	72.99
603113	70-29	1-1/2"	7/16"	Top	500 lbs	71.99

### FAST ENTRY CAM CLEAT- All ship 1 lbs - \*Note: Hole spacing is the same as Harken 150

- Aluminum cams are lightweight and strong • Hardcoat anodized for a durable finish
- Delrin ball bearings ensure smooth cam action

Item	Model	Spacing	Line Size	SWL	Net
613010	70-07	1-1/16"	1/8" - 5/16"	200 lbs	\$18.99
604444	70-17	1-1/2"	1/4"-7/16"	300 lbs	24.99
613013	70-27	2-1/16"	1/4" - 5/8"	500 lbs	31.99
604445	77-17	Black plastic cam fairlead for 70-17			5.99
604446	77-18	Wire cam fairlead with base for 70-17			10.99
604447	78-67	Thimble eye strap SS, 1-9/16" C/C, 5/8" eye width			5.99
613011		Plastic fairlead for 70-07			5.99
		Please Specify Color: Black, Blue, Red, Green or Yellow			
613012	77-08	Small wire fairlead and base for 70-07			6.99

## Series 7 Blocks

Max. line size: 1/2"; Sheave dia.: 2-3/8"; Sheave width: 3/4"; Pin diameter: 1/4"; SWL (Stainless steel and aluminum): 2250 lbs; SWL (Ball Bearing): 1700 lbs

### STAINLESS STEEL BLOCKS

Stainless steel with Black Delrin sheaves

Item	Model	Description	Net
603167	705-05	Single	\$88.99
603171	705-15	Single w/Becket	112.99
603173	705-25	Double	153.99
603175	705-35	Double w/Becket	183.99
603169	705-10	Cheek block, flat base, single, aluminum sheave	121.99
603170	705-11	Cheek block, flat base, single	89.99
603174	705-28	Cheek block, flat base, double*	157.99
603177	705-45	Fiddle	127.99
603178	705-55	Fiddle w/Becket	142.99
603181	705-75	Fiddle w/Cam and becket	236.99
603185	705-94	Triple	179.99
603186	705-95	Triple w/Becket	199.99
603188	705-98	Triple w/Adj. cam and becket	332.99

### ALUMINUM BLOCKS

Anodized aluminum with white Delrin sheaves

Item	Model	Description	Net
603133	704-05	Single w/Univ. head	\$67.99
603136	704-09	Single w/Snap shackle	164.99
603140	704-15	Single w/Univ. head, becket	99.99
603143	704-25	Double w/Univ. head	148.99
603147	704-35	Double w/Becket	181.99
603137	704-10	Cheek block, flat base, single, aluminum sheave	104.99
603138	704-11	Cheek block, flat base, single	76.99

\* SWL: 2250 lbs, lower sheave; 500 lbs, upper sheave

### ALUMINUM BLOCKS (cont'd)

603144	704-28	Cheek block, flat base, double, delrin	\$131.99
603149	704-45	Fiddle w/Univ. head	107.99
603156	704-62	Stand-up swivel	120.99
603152	704-51	Fiddle w/Snap shackle, cam and becket	297.99
603153	704-55	Fiddle w/Univ. head and becket	127.99
603159	704-75	Fiddle w/Univ. head, cam and becket	218.99
603163	704-94	Triple w/Univ. head	157.99
603166	704-98	Triple w/Adj. cam and becket	297.99

### BALL BEARING BLOCKS

Anodized aluminum with White Delrin sheaves and Delrin ball bearings

603189	706-05	Single w/Univ. head	85.99
603192	706-15	Single w/Univ. head and becket	112.99
603194	706-25	Double w/Univ. head	148.99
603195	706-35	Double w/Univ. head and becket	167.99
603191	706-11	Cheek block, flat base, single, Delrin	88.99
603200	706-45	Fiddle w/Univ. head	118.99
603201	706-55	Fiddle w/Univ. head and becket	140.99
603204	706-75	Fiddle w/Univ. head, cam and becket	248.99
603205	706-94	Triple w/Univ. head	188.99
603202	706-62	Stand-up swivel	130.99

## Series 8 Blocks

All versions contain Schaefer's Nomex/Teflon bearing. Max. line size: 9/16"; Sheave dia.: 2-3/8"; Sheave width: 13/16"; Pin diameter: 5/16"; SWL: 2750 lbs

### STAINLESS STEEL BLOCKS

Contains Black Delrin sheave for line only, or aluminum ball bearing "UC" sheave for wire (Max. wire size 3/16") or line.

Item	Model	Description	Net
602577	08-05	Single universal	\$152.99
602578	08-05-UC	Single universal	239.99
602580	08-15	Single/Becket	214.99
602581	08-15-UC	Single/Becket	289.99

Item	Model	Description	Net
602586	08-45	Fiddle	\$302.99
602588	08-55	Fiddle/Becket	315.99
602686	23-55	Fiddle/Cam/Becket	369.99
602590	08-62	Stand-up/Swivel	202.99
602591	08-62-UC	Stand-up/Swivel	293.99

## Universal Adapters

- All adapters are matched to the working load of the block being used • Deck plate allows for removal of the block from deck, if required • The slide fits standard T-track and can be used for jib or genoa sheets

### SERIES 5 UNIVERSAL ADAPTERS

Item	Model	Description	Net
602920	504-01	Snap shackle with univ. adapter	\$121.99
602921	504-02	Deck plate with univ. adapter	61.99
602949	504-73	T-track slide 1" x 1/8"	100.99
603322	78-50	Upset shackle for 5 Series blocks	34.99

### SERIES 7 UNIVERSAL ADAPTERS

Item	Model	Description	Net
603130	704-01	Snap shackle with univ adapter	\$124.99
603131	704-02	Deck plate with univ. adapter	81.99
603139	704-12	Plug; accepts any 7 Series block	98.99
603158	704-73	T-track slider 1-1/4" x 3/16	131.99
603325	78-70	Upset shackle for 7 Series blocks	43.99

## Sheaves

Available in Delrin or aluminum, these sheaves are 5/8" wide and made to fit a range of line or wire sizes. Schaefer does not recommend replacing sheaves from their blocks yourself. Please send the block to Schaefer, and they will repair it. All ship at 1 lbs.

Item	Model	Material	O.D.	Bore	Width	Max Line/Wire	Net
603036	62-018	Delrin	2"	3/8"	5/8"	1/2"	\$18.99
603056	62-051	Delrin	2"	1/2"	5/8"	1/2"	18.99
603044	62-023-15BW	Alum.	2"	3/8"	5/8"	1/2"/3/16"	57.99
603045	62-023-15CW	Alum.	2"	1/2"	5/8"	1/2"/3/16"	69.99
603047	62-030-02	Delrin	1-7/16"	3/8"	5/8"	1/2"	18.99

## SELDÉN



### SELDÉN BLOCKS AND CAM CLEATS - All ship 1 lbs.

Item	Model	Description	Line Size	Working Load	Net
608810	402-201-04	BBB25 High load ball bearing wire block	5 mm	880 lbs	\$18.99
608811	402-201-06	BBB25 High load ball bearing wire block	5 mm	880 lbs	21.99
608819	433-501-01	Mast swivel with cam cleat	7 mm	198 lbs	39.99
	433-501-02	Mast swivel with cam cleat	12 mm	264 lbs	42.99
608820	433-611-01	Swivel base with cam cleat	7 mm	198 lbs	62.99
	433-611-02	Swivel base with cam cleat	12 mm	264 lbs	70.99



## Series 3 Blocks

Max line size: 7/16". Sheave diameter: 1-7/16". SWL: 1000 lbs. All Series 3 blocks ship 1 lbs.

### STAINLESS STEEL BLOCKS

Stainless Steel with White Delrin sheaves.

Item	Model	Description	Net
602557	03-02	Single w/lashing eye	\$43.99
614203	03-03	Single w/front-side shackle	51.99
614204	03-04	Single w/upset shackle	52.99
614205	03-05	Single w/swivel shackle	53.99
614206	03-07	Single w/swivel eye	52.99
602566	03-30	Cheek block, curved base, single	41.99

**WE CAN SPECIAL ORDER ADDITIONAL SCHAEFER HARDWARE. PLEASE VISIT [WWW.SCHAEFERMARINE.COM](http://WWW.SCHAEFERMARINE.COM) FOR TECH INFO AND THEN CALL OR EMAIL US TO ORDER.**

\* Upper block safe working load 200 lbs.

### ALUMINUM BLOCKS

Anodized aluminum with white Delrin sheaves.

Item	Model	Description	Net
602729	303-03	Single w/front-side shackle	\$51.99
602730	303-05	Single w/swivel shackle	53.99
602732	303-13	Single w/front-side shackle and becket	64.99
602733	303-15	Single w/swivel shackle and becket	65.99
602734	303-23	Double w/front-side shackle	81.99
602735	303-29	Cheek block, flat base, double*	68.99
602731	303-09	Cheek block, flat base, single	44.99
602736	303-30	Cheek block, curved base, single	40.99

### BALL BEARING BLOCKS

Anodized aluminum w/ White Delrin sheaves and Delrin ball bearings.

Item	Model	Description	Net
602712	300-02	Single w/lashing eye	\$53.99
602714	300-05	Single with swivel shackle	60.99
602717	300-30	Cheek block, curved base, single	46.99
602715	300-09	Cheek block, flat base, single	59.99

## Series 5 Blocks

Max line size: 7/16". Sheave diameter: 2". SWL (non-bearing stainless steel and aluminum): 1750 lbs.  
SWL (Ball Bearing): 1500 lbs. All Series 5 blocks ship 2 lbs

### STAINLESS STEEL BLOCKS

Stainless steel with Black Delrin sheaves.

Item	Model	Description	Net
602959	505-05	Single w/Univ. head	\$53.99
602963	505-15	Single w/becket and universal head	83.99
602961	505-10	Cheek block, flat base, single*	90.99
602962	505-11	Cheek block, flat base, single	56.99
602966	505-28	Cheek block, flat base, double**	96.99
602965	505-25	Double with universal, high strength head	126.99
602967	505-35	Double with becket and universal, high strength head	143.99
602969	505-45	Fiddle	97.99
602970	505-55	Fiddle w/becket	110.99
602974	505-75	Fiddle w/cam and becket	176.99
602975	505-76	Fiddle w/adj. cam and becket	216.99
602979	505-90	Triple	143.99

### BALL BEARING BLOCKS

Anodized aluminum w/White Delrin sheaves and Delrin ball bearings.

Item	Model	Description	Net
602983	506-05	Single w/Univ. head	\$59.99
602985	506-11	Cheek block, flat base, single	74.99
602986	506-15	Single w/Univ. head and becket	83.99
602996	506-45	Fiddle w/Univ. head	107.99

\*Aluminum sheave instead of Delrin.

\*\*Upper block safe working load 350 lbs.

### BALL BEARING BLOCKS

Item	Model	Description	Net
603000	506-75	Fiddle w/Univ. head, cam & becket	\$180.99
603001	506-90	Triple w/Univ. head	169.99

### ALUMINUM BLOCKS

Anodized aluminum with White Delrin sheaves.

Item	Model	Description	Net
602923	504-05	Single w/Univ. head	\$47.99
602926	504-09	Single w/snap shackle	121.99
602927	504-10	Cheek block, flat base, single*	87.99
602928	504-11	Cheek block, flat base, single	49.99
602929	504-15	Single w/Univ. head and becket	59.99
602932	504-25	Double w/Univ. head	106.99
602933	504-28	Cheek block, flat base, double**	97.99
602936	504-35	Double w/Univ. head and becket	121.99
602938	504-45	Fiddle w/Univ. head	90.99
602939	504-49	Fiddle w/Snap shackle	160.99
602941	504-51	Fiddle w/Cam, snap shackle and becket	218.99
602942	504-55	Fiddle w/Univ. head and becket	100.99
602950	504-75	Fiddle w/Univ. head, cam and becket	157.99
602951	504-76	Fiddle w/adj. cam and becket	173.99

# SCHAEFER

LEGENDARY STRENGTH

## Series 5

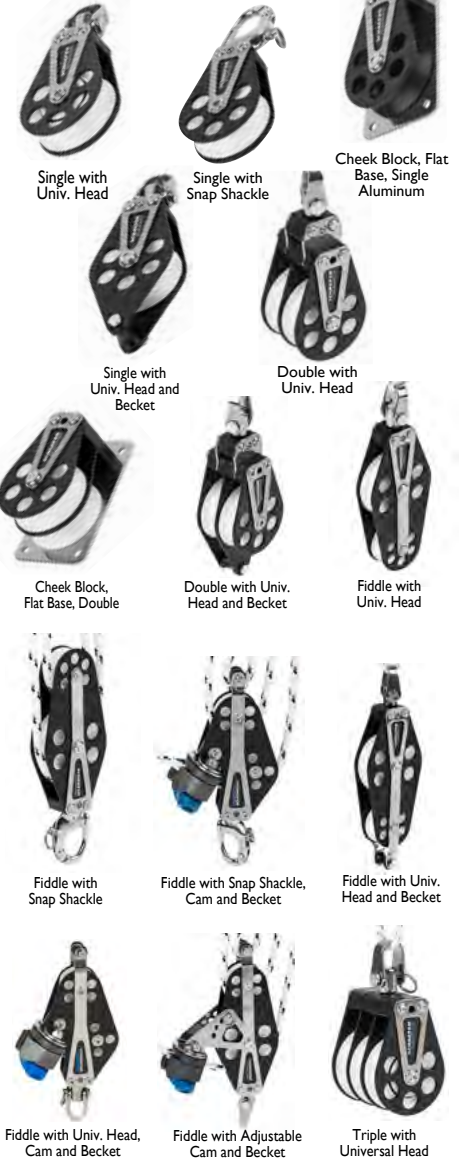

## Halyard Leads

Almost every possible arrangement for deflecting halyards aft is offered here. Easily lead halyards, topping lifts and other control lines aft with our large selection of Schaefer halyard lead and control blocks. All blocks shown here ship at 1 lbs.

### SERIES 3 BALL BEARING BLOCK

Item	Model	Description	Max Line/Wire	SWL	Net
602726	300-62	Stand up swivel	7/16"	1000 lbs	\$96.99
602719	300-32	Fairlead block on hinged base	7/16"	1000 lbs	103.99
602718	300-31	Fixed fairlead block	7/16"	1000 lbs	37.99

### SERIES 7 BALL BEARING BLOCK

603202	706-62	Stand up swivel	1/2"	2250 lbs	130.99
--------	--------	-----------------	------	----------	--------

### HINGED FAIRLEAD BLOCK

602990	506-32	Hinged fairlead/Ball bearing	7/16"	1000 lbs	128.99
--------	--------	------------------------------	-------	----------	--------

### SERIES 3 PLAIN BEARING BLOCK

602740	303-50	Halyard lift block	7/16"	1000 lbs	48.99
602743	303-62	Stand up swivel	7/16"	1000 lbs	87.99

### SERIES 5 PLAIN BEARING BLOCKS

602946	504-62	Stand up swivel block on deck plate	7/16"	1750 lbs	102.99
--------	--------	-------------------------------------	-------	----------	--------

### SERIES 7 PLAIN BEARING BLOCK

603156	704-62	Stand up swivel	1/2"	2250 lbs	\$120.99
--------	--------	-----------------	------	----------	----------

### HALF-MOON MAST BASE BLOCK

602768	32-17	Half-moon/Hinged/Alum.	3/8" / 3/16"*	3000 lbs	284.99
--------	-------	------------------------	---------------	----------	--------

\*3/16" size is wire

## Over-the-Top Blocks

Designed for bringing control line over the forward edge of cabins or dog houses. All blocks require (6) fasteners.

Item	Model	No. of Sheaves	Sheave Dia.	Line Dia.	SVL	Ship	Net
602723	300-40	1	1-7/16"	7/16"	650 lbs	1 lbs	\$57.99
602724	300-41	2	1-7/16"	7/16"	650 lbs	1 lbs	90.99
602725	300-42	3	1-7/16"	7/16"	650 lbs	1 lbs	130.99
602992	506-40	1	2"	7/16"	1000 lbs	1 lbs	87.99
602993	506-41	2	2"	7/16"	1000 lbs	1 lbs	124.99
603196	706-40	1	2-3/8"	1/2"	1200 lbs	1 lbs	104.99
603197	706-41	2	2-3/8"	1/2"	1200 lbs	1 lbs	143.99

## Halyard Leads



## Over-the-Top



❖ For more detailed product specifications and our complete selection visit [www.defender.com](http://www.defender.com) or call 800-628-8225. ❖

# RONSTAN

## COREBLOCKS™

### Series 60

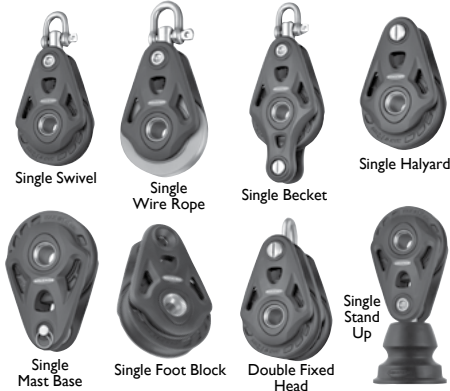

## Series 40 mm & 50 AP Blocks



## ORBITBLOCKS™ Series 30 & 40



## Ball Bearing Series 20

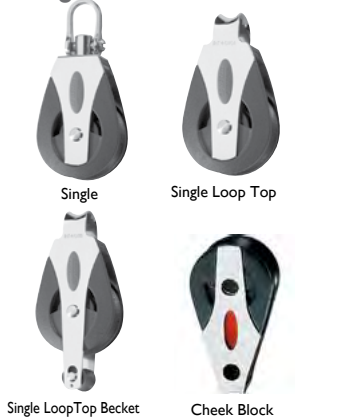

Constrictor 14

## Ronstan Series 60/75 COREBLOCKS™

All Ship 1 lbs

Ronstan's versatile CoreBlocks are the right choice for sheets, halyards and control lines for cruising and racing applications. The tuned 2-stage bearing system provides excellent performance across the full working load range with the resilience to handle both high dynamic and static loads. Alloy cheeks and stainless fixings complete the durable, long lasting package.

Item	Model	Description	MWL	M.A.P.
603513	RF64100	Single swivel	2200	\$79.95
603514	RF64100AW	Single wire rope	2200	119.95
603515	RF64110	Single becket	2200	99.95
603516	RF64108	Single halyard	2200	89.95
603517	RF64108A	Single mast base	2200	69.95
603518	RF64108AW	Single wire halyard	2200	\$159.95
603519	RF64151	Single foot block	2200	84.95
603520	RF64202	Double fixed head	2200	159.95

Item	Model	Description	MWL	M.A.P.
603521	RF64140	Single stand up	2200	139.95
603522	RF74100	Single swivel	3300	107.95
603526	RF74108A	Single mast base	3300	76.95
603529	RF74140	Single stand up	3300	199.95
603524	RF74110	Single with becket	3300	127.95
603525	RF74108	Single halyard	3300	101.95

Note: Line size for Series 60 is 1/2" Line size for Series 75 is 9/16"

## Ronstan Series 50/60 mm AP Blocks

All Ship 1 lbs

All purpose (AP) blocks are a great all around solution. Self-lubricating Acetal polymer sheaves running on polished stainless steel races perform equally well with dynamic loads and high static loads. For durability and a long service life, these blocks are the right choice for sheets, halyards and control line applications for cruising and racing.

- Exceptionally high working loads
- Low maintenance, long service life
- Self-lubricating sheave

Item	Model	Description	MWL	M.A.P.
602512	RF51530	Fiddle, cleat, becket, universal	1650	\$110.95
602511	RF51510	Fiddle, becket, universal	1650	62.95
602510	RF51500	Fiddle, universal	1650	56.95
602509	RF51300	Triple, universal head	2650	84.95
602508	RF51210	Double, becket	2200	74.95

Item	Model	Description	MWL	M.A.P.
602507	RF51200	Double, universal	2200	\$63.95
602504	RF51110	Single, becket, universal	1650	42.95
602503	RF51101	Single, loop head	1650	28.95
602502	RF51100	Single, universal head	1650	29.95
615422	RF66100	Single	2400	39.95

Note: Line size for Series 50 is 1/2" Line size for Series 60 is 9/16"

## Ronstan Series 40 mm AP and Ball Bearing Blocks

All Ship 1 lbs

Item	Model	Description	MWL	M.A.P.
613530	RF41100	Single, universal head	880	\$19.95
613532	RF41101	Single, loop head	880	16.95
613854	RF41110	Single becket, universal head	880	27.95
613533	RF41111	Single, becket, loop head	880	25.95
613545	RF41140	Single, stand-up	880	29.95
613547	RF41151	Single, cheek	880	29.95

Item	Model	Description	MWL	M.A.P.
613539	RF41500	Fiddle, universal head	880	42.95
613540	RF41510	Fiddle, 265 becket, universal head	880	45.95
613853	RF41520	Fiddle adjustable cleat, universal head	880	90.95
613518	RF40500	Fiddle, universal head	770	48.95
613522	RF40530	Fiddle, becket, adjustable cleat, universal head	770	83.95

Note: Line size for single, double and triple is 7/16" and 5/16" for fiddle blocks

## NEW 15MM BLOCKS AVAILABLE AT WWW.DEFENDER.COM

## Ronstan Series 30 Ball Bearing ORBITBLOCKS™ and Accessories

All Ship 1 lbs

- Lightweight • Highest working load in its class • Simple, versatile and secure attachment • Low profile and compact • 1-3/16" sheave for 5/16" maximum line diameter

Item	Model	Description	MWL	M.A.P.
615265	RF35100	Single and becket swivel	660	\$19.95
615267	RF35100D	*Single and becket swivel	660	29.95
615268	RF35101	Single becket lashing head	660	13.95
615270	RF35140	Single stand up swivel	660	25.95
615271	RF35141	Single stand up fixed	660	22.95
615272	RF35151	Single cheek block	660	15.95

Item	Model	Description	MWL	M.A.P.
615273	RF35202	Double becket	990	33.95
615276	RF35286	Clew ring linked	660	33.95
615277	RF35302	Triple	1210	45.95
615278	RF35312	Triple becket	1210	47.95
615280	RF35332	Triple becket cleat	1210	77.95
615281	RF1849-2	D shackle, 2 pack	NA	9.95
615282	RF1850S-2	Wide D shackle, 2 pack	NA	10.95
614370	RF30174	Upright lead block	660	44.95

\*"D" indicates self-lubricating Nylatron sheave.

## Ronstan Ball Bearing Series 20

All Ship 1 lbs

3/4" sheaves for a 1/4" maximum line diameter. High working loads. High load blocks (HL) do not have ball bearings.

Item	Model	Description	MWL	M.A.P.
615283	RF25109	Single becket lashing head	550	\$12.95
614278	RF20100	Single swivel	550	18.95
614279	RF20101	Single loop top	550	10.99
614280	RF20101HL	Single loop top, HL	610	19.95
614281	RF20111	Single loop top, becket	550	13.95
614295	RF20184	Single loop mount	550	16.95
614286	RF20202	Double, 2-axis shackle head	770	27.95
614287	RF20212	Double, becket, 2-axis shackle head	770	30.95
614296	RF20281	Double in-line	550	29.95
614283	RF20151	Cheek block	550	14.95
614288	RF20302	Triple, 2-axis shackle head	880	37.95

Item	Model	Description	MWL	M.A.P.
614289	RF20312	Triple, becket, 2-axis shackle head	880	\$40.95
614290	RF20332	Triple, becket, cam cleat 2-axis shackle head	880	79.95
614291	RF20711	Exit block, cover plate	550	28.95
614292	RF20711A	Exit block, side tabs	550	27.95
614293	RF20711HL	Exit block, cover plate, HL	610	32.95
614282	RF20141	Stand-up block	550	18.95
614294	RF20174	Pivoting lead block	550	33.95
614297	RF20284	Linked blocks, twin singles	550	22.95

Visit [www.defender.com](http://www.defender.com) for additional Ronstan blocks. Defender can Special Order any blocks not listed.

### RONSTAN SHOCK BLOCK SHEAVELESS BLOCK

- Line Size: 3/8"
- Breaking Load: 2200 lbs
- Material: Anodized aluminum

Specify Color: Blue or Red

Item 615419 Ship 1 lbs M.A.P. \$11.95 each

- Line Size: 3/16"
- Breaking Load: 770 lbs
- Material: Anodized aluminum

Specify Color: Blue, Gray or Red

Item 615418 Ship 1 lbs M.A.P. \$15.95/pair



### RONSTAN CONSTRICTOR TEXTILE ROPE CLUTCH

The Constrictor® rope clutch provides increasing holding power as the load increases. The rope runs freely through the sock in one direction but is gripped instantly within the sock when running out in the opposite direction.

Item	Clutch size (rope)	Weight	Breaking Load	M.A.P.
615366	Constrictor 6 (1/4")	5.3 oz.	1670 lbs	\$164.95
615367	Constrictor 8 (5/16")	5.4 oz.	2570 lbs	164.95
615368	Constrictor 10 (3/8")	4.6 oz.	4920 lbs	174.95
615369	Constrictor 12 (1/2")	11.6 oz.	6270 lbs	189.95
615370	Constrictor 14 (9/16")	12.0 oz.	8290 lbs	189.95





**NEW!**

**C.S. JOHNSON HINGED PAD EYES**

- Folds flat when not in use
- Material is all T-316 stainless
- The eye gives with the load unlike rigid pad eyes; materially reducing the load on the fastenings
- Friction drag ensures that the eye stays in position and is rattle free
- Supplied with backing plate
- Bolts for fastening are not supplied

Item	Model	Size	SWL	Bolts Required	Ship	Net
615571	48-570	3/16"	400 lbs	(2) 3/16"	1 lbs	\$17.99
	48-580	1/4"	1000 lbs	(3) 1/4"	1 lbs	30.99
	48-585	5/16"	1500 lbs	(3) 5/16"	1 lbs	55.99
	48-590	3/8"	2500 lbs	(3) 3/8"	1 lbs	66.99
	48-595	1/2"	3500 lbs	(3) 1/2"	1 lbs	111.99

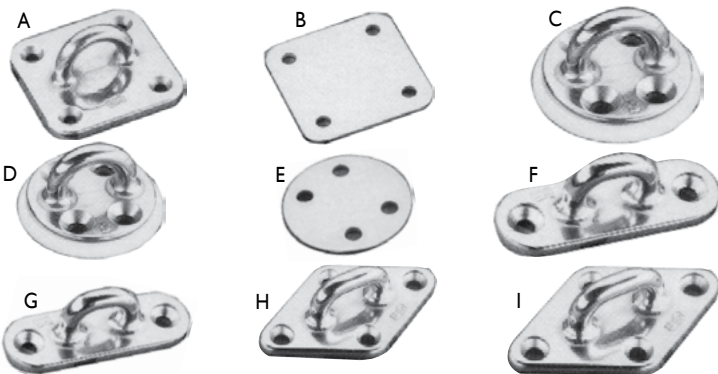

**SCHAEFER CAST PADEYES**

Investment cast and made from 316 stainless steel. Ship 1 lbs.

Item	Pict.	Model	Base	Eye Height	SWL/lbs	Fasteners	Net
603502	A	97-42	3" Square base	3/4"	4000	(4) 1/4"	\$57.99
603504	B	97-52	3" Wide backing plate for A				19.99
603305	C	78-17	3" Round base	7/8"	8500	(4) 3/8"	65.99
603304	D	78-07	2.5" Round base	13/16"	4000	(4) 1/4"	47.99
603505	E	97-53	Backing plate for D				18.99
603337	F	78-99	4" Oblong base	3/4"	3500	(2) 5/16"	50.99
603307		78-25	4-1/4" x 1-1/4" Oval base	1"	3000	(2) 3/8"	74.99
603308		78-26	Backing plate for 78-25				17.99
603336	G	78-98	3" Oblong base	1/2"	2200	(2) 1/4"	43.99
603335	H	78-96	4" Diamond base	5/8"	4000	(4) 1/4"	54.99
603334	I	78-95	3-1/8" Diamond base	7/16"	4000	(4) 1/4"	41.99

**SCHAEFER WELDED PADEYES**

- Welded stainless steel ring
- Fabricated from 304 stainless steel with stamped bases
- (2) #10 RH (5 mm) fasteners (sold separately)

Item	Oval Base	Eye Width	Eye Height	Working Load	Ship	Net
603300	3" x 1"	7/8"	7/8"	2500 lbs	1 lbs	\$26.99
603303	2-1/4" x 5/8"	1/2"	1/2"	750 lbs	1 lbs	25.99
603302	2" x 5/8"	1/2"	1/2"	650 lbs	1 lbs	22.99

**ALLEN STAINLESS STEEL FOLDING PADEYES**

- Folding stainless steel pad eyes
- Fully polished finish
- 316 polished stainless steel
- All ship 1 lbs.

Item	Model	Inside Dia	Height	MWL	Break Load	Net
604465	PB181/I Single	28 mm	18 mm	2900 lbs	3250 lbs	\$21.99
604466	PB182/I Single	35 mm	20 mm	4900 lbs	9900 lbs	23.99
604467	PB185/I Double	75 mm	22 mm	9600 lbs	19800 lbs	61.99

**SCHAEFER REMOVABLE DECK EYE PLATE ASSEMBLY**

- Safe working load: 2250 lbs
- Base plate diameter: 2-1/2"

Item	Model	Description	Ship	Net
603331	78-83	Base plate, threaded deck eye and threaded Delrin plug	1 lbs	\$139.99
603329	78-81-02	Removable Delrin plug	1 lbs	22.99
603330	78-82	Removable threaded deck eye	1 lbs	49.99



**SUNCOR HEAVY DUTY FOLDING PADEYE**

- Type: Single folding
- Material: Precision Cast 316 stainless steel
- All ship 1 lbs

Item	Model	A	B	C	D	E	Working Load	Net
607620	S3712-0001	1/4"	1.06"	1.53"	0.94"	0.50"	1200 lbs	\$20.99
	S3712-0002	5/16"	1.38"	1.94"	1.25"	0.69"	2000 lbs	20.99
	S3712-0003	3/8"	1.75"	2.53"	1.63"	0.84"	4000 lbs	34.99

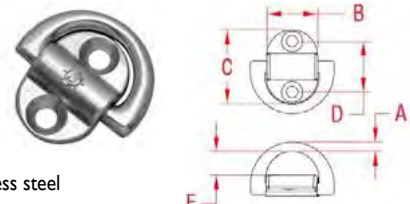

**SUNCOR UNIVERSAL BACKING PLATE**

- Applications: folding and heavy duty folding pad eye
- Material: grade 316 stainless steel, diameter: 2-1/2"
- Provides maximum load distribution

Item	Model	Ship	Net
607621	S3712-0005	1 lbs	\$6.99

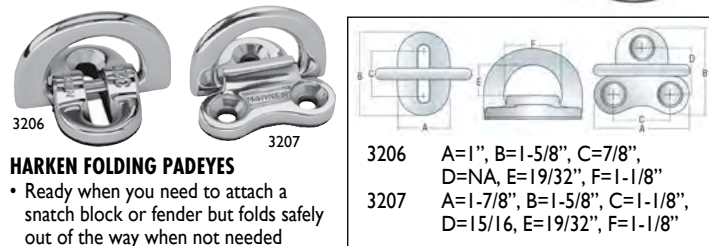

**HARKEN FOLDING PADEYES**

- Ready when you need to attach a snatch block or fender but folds safely out of the way when not needed
- Bolt-down bases and D-rings are 316 stainless steel
- A vulcanized thermoplastic pad prevents rattling and holds the D-ring in position

Item	Model	Description	MWL	Ship	Net
603109	3206	For standard loads	1760 lbs	1 lbs	\$31.99
603110	3207	For higher loads	3080 lbs	1 lbs	54.99



**WICHARD PADEYES** All ship 1 lbs.

**Toerail Padeyes**

Protects toerails by spreading the load and reducing nicks and dents.

Item	Model	A Min-Max"	B Dimension"	C Min-Max"	Working Load	Net
607640	16613	.35 - .51	1.57 minimum	.08 - .16	2116 lbs	\$140.99
607641	16614	.35 - .51	1.57 minimum	.08 - .20	2116 lbs	140.99
607642	16615	.47 - .60	1.77 minimum	.16 - .24	2645 lbs	158.99

**Stainless Steel Folding Padeye**

Universal Single with Silicon pad.

Item	Model	Breaking Load	SWL	Net
613335	6684	3527 lbs	1653 lbs	\$33.99

**Stainless Steel Folding Padeye**

Folds down to low profile when not in use.

Item	Model	Eye Width	Eye Height	WLL	Break Load	Net
615428	06604	27 mm (1-1/16")	14 mm (1/2")	3174 lbs	3000 kg	\$48.99
615429	06605	35 mm (1-3/8")	17 mm (5/8")	5291 lbs	5000 kg	58.99

**Stainless Steel Double Folding Padeye**

Silicone pad prevents noise and vibrations.

Item	Model	Eye Width	Eye Height	SWL	Break Load	Net
607740	6564	27 mm (1-1/16")	14 mm (1-3/4")	3168 lbs	5500 lbs	\$89.99
607741	6566	45 mm (1-3/4")	23 mm (7/8")	10,032 lbs	19,800 lbs	170.99

**M A P \$** Some manufacturers set M.A.P. (Minimum Advertised Pricing) for their products, so we cannot advertise a lower price. However, this does not always apply to selling price. The actual price you will be charged is probably lower. Please call us at 800-628-8225 for further details.

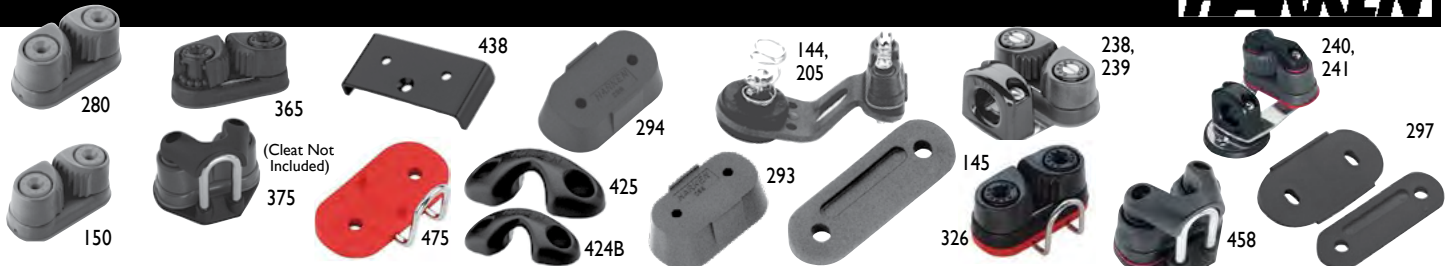

**HARKEN CAM CLEATS** All ship 1 lbs

Item	Model	Description	Max. Line	Min. Line	Max. W/kg Load	Breaking Strength	Cam Material	Net
604908	280	Offshore Cam-matic	5/8"	1/4"	500 lbs	1000 lbs	Aluminum	\$52.99
604799	150*	Cam-matic	1/2"	1/8"	300 lbs	750 lbs	Aluminum	33.99
604970	365	Carbo-cam	3/8"	1/8"	200 lbs	500 lbs	Plastic/Carbon	26.99
615176	471*	Micro carbo-cam II	1/4"	1/8"	150 lbs	300 lbs	Plastic/Carbon	23.99
601175	150SP	Modified cam cleat	1/2"	1/8"	300 lbs	750 lbs	Plastic/Carbon	50.99

**Accessories**

Item	Model	Description	Fits	Net
600112	375	X-treme angle cam fairlead	150 / 365	\$17.99
615177	476	X-treme angle cam fairlead	468 / 471	15.99
600116	438	Cam adapter plate to heighten cleat	150 / 365	12.99
604924	296	15° angled Cam-matic riser	150 / 365	10.99
604926	298	Wire fairlead	150 / 365	8.99
604923	295	Flat Cam-matic riser	150 / 365	7.99
604922	294	15° angled micro cam riser	468 / 471	6.99
615178	475	Micro wire fairlead	468 / 471	6.99
600115	425B	Fairlead, Black	150 / 365	6.99
600114	424B	Micro fairlead, Black	468 / 471	5.99
604921	293	Flat micro cam riser	468 / 471	4.99
604910	282	Offshore eyestraps	280	3.99

\*Model 150 uses #10 mounting screws. Model 471 uses #8 mounting screws. Model 280 uses 1/4" screws.

**Harken Carbo Lead Blocks**



- High-strength pivoting lead blocks with cams are used for halyard controls on larger keelboats and as "head knockers" on dinghies and beachcats for sheeting directly from the boom
- Hole spacing and rivet size are the same as classic models, making upgrades easy
- Cam reverses for either up or down cleating
- Can be used as becket block

**HARKEN 29 MM PIVOTING LEAD BLOCK** All ship 1 lbs

Item	Model	Max Line	MWL	Breaking Load	Sheave	Length	Net
606786	395	1/4"	200 lbs	650 lbs	1-1/8"	3-15/16"	\$58.99

**With Carbo Cam Cleat**

606787	396	1/4"	150 lbs	650 lbs	1-1/8"	3-15/16"	\$54.99
--------	-----	------	---------	---------	--------	----------	---------

**HARKEN 40 MM PIVOTING LEAD BLOCK** All ship 1 lbs

Item	Model	Max Line	MWL	Breaking Load	Sheave	Length	Net
606791	2156	3/8"	300 lbs	950 lbs	1-9/16"	4-1/2"	\$67.99

**With Carbo Cam Cleat**

606792	2157	3/8"	200 lbs	950 lbs	1-9/16"	4-1/2"	\$62.99
--------	------	------	---------	---------	---------	--------	---------

**Clamcleat® V Cleats**



**VERTICAL CLEATS - BLACK** All ship 1 lbs  
Black models are nylon; Silver models are aluminum.

Item	Model	Description	Line Size	Net
612081	CL201	Vertical	1/4"-1/2"	\$8.49
612082	CL204	Mini	1/8"-1/4"	4.49
612083	CL205	Major	3/8"-5/8"	13.99

**HORIZONTAL - BLACK** All ship 1 lbs

612088	CL202	Horizontal	1/4"-3/8"	\$11.99
612091	CL213	Fine line/Stbd.	1/16"-3/16"	4.29
612092	CL214	Fine line/Port	1/16"-3/16"	4.29

**TAPERED PAD**

612100	CL804	for CL201, CL219, 219AN, 237 and 238		\$3.29
--------	-------	--------------------------------------	--	--------

**ROLLER CLEATS** All ship 1 LBS

Item	Model	Description	Line Size	Net
612094	CL236	Roller fairlead, MK I Alum. racing jr. Silver	1/8"-1/4"	\$14.99

**FAIRLEAD CLEATS**

612106	CL203	Junior Black	1/8"-1/4"	4.99
612107	CL211MK1	Mk I racing junior Silver	1/8"-1/4"	10.99
612111	CL228	Vertical with integral fairlead Black	1/4"-1/2"	12.99
612112	CL231	Midi with integral fairlead Black	5/32"-5/16"	6.99
612113	CL232	Cub Black	1/8"-1/4"	4.99

**HARKEN CAM & SWIVEL BASES** All ship 1 lbs

Item	Model	Description	Line Size	Cam model	Net
604845	205	Standard low profile cam base — swivel	1/8"-1/2"	150 Cam-matic cleat	\$128.99
604794	144	Standard swivel base	1/8"-1/2"	150 Cam-matic cleat	142.99
604871	238	Cam on plate w/bullseye	1/8"-1/2"	Aluminum 150 Cam-matic	55.99
604872	239	Cam on plate w/bullseye	1/8"-3/8"	365 Carbo cam	48.99
604873	240	Bullseye w/swivel	1/8"-1/2"	Aluminum 150 Cam-matic	80.99
604874	241	Base and cam Bullseye w/swivel	1/8"-3/8"	365 Carbo cam	73.99

**HARKEN CAM CLEAT KITS & ACCESSORIES** All ship 1 lbs

Item	Model	Description	Cam	Fairlead	Net
600818	459	Cam-matic with X-treme fairlead	150	X-treme 375	\$49.99
604950	326	Carbo cam w/wire fairlead	365	298	35.99
604951	327	Cam-matic w/wire fairlead	150	298	42.99
600822	458	Carbo cam with X-treme fairlead	365	375	42.99
601190	150KIT	Rebuild kit for 150, 1993+	150		16.99
604911	283	Offshore cam wedge kit	280		5.99
604795	145	Cam-matic wedge kit	150/365		5.99
604925	297	Micro cam wedge kit	468/471		4.99



**RONSTAN 180° SWIVELING CLEAT PLATFORM** All ship 1 lbs

- Permits easy cleating and releasing from any angle
  - 28 mm (1-1/4") diameter ball bearing sheave
  - RF5001 composite fiber T-cleat and fast track fairlead
- | Item   | Model | MWL     | Breaking Load | Rope Size     | M.A.P.  |
|--------|-------|---------|---------------|---------------|---------|
| 601240 | RF5   | 330 lbs | 660 lbs       | 3/32" - 5/16" | \$57.95 |

**RONSTAN SWIVELING CLEAT BASE** All ship 1 lbs

- Easy cleating and releasing from any angle
- Height adjustable arm
- Adjustable ratchet system prevents arm from falling to leeward
- Fork fittings with 5 mm pin permits direct attachment of block to the head post
- Suits traditional post/shackle head blocks and Dyneema® Link head Orbit Blocks™
- Twin ball bearing race; 260° rotation

Item	Model	MWL	Breaking Load	Line Size	M.A.P.
601241	RF7	473 lbs	946 lbs	1/8"-1/2"	\$119.95

**C-CLEATS & T-CLEATS** All ship 1 lbs

- C-cleats - Carbon fiber cam provides maximum resistance to heat and abrasion
- T-cleats - Glass fiber composite cams offer great value for most cleating applications

Please Specify Color: Blue, Green, Yellow, Red or Black

Item	Model	Description	MWL	Rope Capacity	M.A.P.
601186	RF5400	Small "C-cleat"	165 lbs	3/32" - 5/16"	\$23.95
601204	RF5410	Medium "C-cleat"	275 lbs	1/8" - 1/2"	25.95
601205	RF5420	Large "C-cleat"	510 lbs	1/4" - 5/8"	46.95
602335	RF5001	Small "T-cleat"; Red only	165 lbs	3/32"-5/16"	22.95
602344	RF5011	Medium "T-cleat"; Red only	275 lbs	1/8"-1/2"	25.95

**SPINLOCK PXR CAM CLEATS** All ship 1 lbs

- Compact, precise control for hand-tensioned lines; easy release under load
- Stainless steel rope guides provide wide operating arc
- Integral 6° wedge
- Alloy cam and base standard
- T-series for retrofit in hole centers of traditional cam cleats
- SW-series swivel mounted PXR
- VP-series mast mounted PXR

Item	Model	Configuration	Line Range	SWL	Net
615149	PXR0206	Single	3/32" - 1/4"	308 lbs	\$40.99
615145	PXR0206/T	Single	3/32" - 1/4"	308 lbs	41.99
615147	PXR0206/SW	Single	3/32" - 1/4"	308 lbs	57.99
615151	PXR0206/VP	Single	3/32" - 1/4"	308 lbs	63.99
615150	PXR0810	Single	5/16" - 3/8"	440 lbs	49.99
615146	PXR0810/T	Single	5/16" - 3/8"	440 lbs	54.99
615148	PXR0810/SW	Single	5/16" - 3/8"	440 lbs	72.99

PLEASE VISIT WWW.DEFENDER.COM FOR CLEAT ACCESSORIES



# Clutches & Deck Organizers

## SPINLOCK XAS ROPE CLUTCH

For racers to 27' and cruisers to 35'. Made from UV stabilized composites. Provides the same footprint and hole pattern as the original XA. XAS0408 has been optimized for maximum holding of small diameter lines. Easily side-mounted with the addition of the XAS-SMNT fairing kit. Uses (2) 1/4" fasteners for mounting (Not included).



Item	Model	Type	Line Size	SWL	Ship	Net
614517	XAS0408/1	Single	5/32" - 5/16"	880 lbs	1 lbs	\$86.99
614518	XAS0408/2	Double	5/32" - 5/16"	880 lbs	2 lbs	159.99
614519	XAS0408/3	Triple	5/32" - 5/16"	880 lbs	2 lbs	239.99
614520	XAS0612/1	Single	1/4" - 1/2"	1270 lbs	1 lbs	86.99
614521	XAS0612/2	Double	1/4" - 1/2"	1270 lbs	2 lbs	154.99
614522	XAS-0612/3	Triple	1/4" - 1/2"	1270 lbs	2 lbs	230.99
614523	XAS-SMNT	Side mount kit (Includes fairing and fasteners)			1 lbs	51.99

## SPINLOCK POWERCLUTCH XTS & XCS

Made of UV stabilized composites. XTS has extruded alloy handle with soft end grip. Secure handle lock. XCS has metal sides for sustained high load operation. Uses 5/16" flat head screws (not included).



Item	Model	Color	Type	Line Dia.	SWL	Ship	Net
608190	XTS0610/1	Black	Single	1/4 - 3/8"	2200 lbs	3 lbs	\$139.99
	XTS0814/1	Black	Single	5/16 - 9/16"	2200 lbs	3 lbs	139.99
608191	XTS0610/2	Black	Double	1/4 - 3/8"	2200 lbs	3 lbs	237.99
	XTS0814/2	Black	Double	5/16 - 9/16"	2200 lbs	4 lbs	237.99
608192	XTS0610/3	Black	Triple	1/4 - 3/8"	2200 lbs	4 lbs	362.99
	XTS0814/3	Black	Triple	5/16 - 9/16"	2200 lbs	4 lbs	362.99
608318	XCS0610/1B	Black	Single	1/4 - 3/8"	2200 lbs	1 lbs	223.99
	XCS0610/1W	White	Single	1/4 - 3/8"	2200 lbs	2 lbs	223.99
	XCS0814/1B	Black	Single	5/16 - 9/16"	2200 lbs	2 lbs	223.99
	XCS0814/1W	White	Single	5/16 - 9/16"	2200 lbs	2 lbs	223.99
608320	XCS0610/3B	Black	Triple	1/4 - 3/8"	2200 lbs	4 lbs	504.99
	XCS0610/3W	White	Triple	1/4 - 3/8"	2200 lbs	4 lbs	504.99
	XCS0814/3B	Black	Triple	5/16 - 9/16"	2200 lbs	4 lbs	504.99
	XCS0814/3W	White	Triple	5/16 - 9/16"	2200 lbs	4 lbs	504.99

## SPINLOCK XTR ROPE CLUTCH

Significant holding power improvement on the latest small diameter ropes. Line holding is consistent and fast across the full range of line diameters. Ultra lightweight alloy/composite construction.



Please specify color: Black, Silver or White

Item	Model	Type	Line Dia.	SWL	Ship	Net
606927		Single	5/16"-1/2"	2200 lbs	1 lbs	\$128.99
606928	XTR-SMNT	XTR side mount kit (vertical surface)			1 lbs	39.99

## ROPE CLUTCH SERVICE KITS

Item	Model	Description	Ship	Net
601148	XTS-KIT	For XTS clutch - Base, cam and handle	1 lbs	\$76.99
615311	XA-KIT	For XA series - Base, cam, sides and handle	1 lbs	41.99
615312	XAS-KIT	For XAS series - Base, cam, sides and handle	1 lbs	41.99

★ Spinlock Single Line XX Powerclutch can be found at [www.defender.com](http://www.defender.com) ★

## SPINLOCK REPLACEMENT CAM PARTS

Item	Model	Description	Line Size	Ship	Net
608408	CAM-0610C	Replacement ceramic cam	6-10 mm	1 lbs	\$75.99
	CAM-0814C	Replacement ceramic cam	8-14 mm	1 lbs	75.99
608409	X-BASEC	Replacement ceramic base		1 lbs	56.99

## SCHAEFER DECK ORGANIZER BLOCKS

All ship 2 lbs except 704-31, which ships 3 lbs. Designed to run multiple halyards and control lines aft from the mast to rope clutches or winches near the cockpit. Delrin™ sheaves provide low friction and gentle support to extend the working life of rope halyards and control lines.

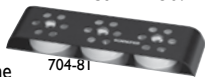

Item	Model	Sheaves	Sheave Dia.	Line Dia.	SWL	Fastener	Net
602747	303-80	2	1-7/16"	7/16"	1250 lbs	1/4"	\$79.99
602748	303-81	3	1-7/16"	7/16"	1250 lbs	1/4"	97.99
602952	504-80	2	2"	7/16"	1950 lbs	1/4"	87.99
602953	504-81	3	2"	7/16"	1950 lbs	1/4"	112.99
602934	504-30*	4	2"	7/16"	1950 lbs	1/4"	134.99
602935	504-31*	6	2"	7/16"	1950 lbs	1/4"	174.99
602976	505-80 (SS)	2	2"	7/16"	1950 lbs	1/4"	97.99
602977	505-81 (SS)	3	2"	7/16"	1950 lbs	1/4"	118.99
603160	704-80	2	2-3/8"	1/2"	3000 lbs	5/16"	124.99
603161	704-81	3	2-3/8"	1/2"	3000 lbs	5/16"	168.99
603145	704-30*	4	2-3/8"	1/2"	3000 lbs	5/16"	212.99
603146	704-31*	6	2-3/8"	1/2"	3000 lbs	5/16"	293.99
603182	705-80 (SS)	2	2-3/8"	1/2"	3000 lbs	5/16"	167.99
603183	705-81 (SS)	3	2-3/8"	1/2"	3000 lbs	5/16"	210.99

Aluminum sheaves are available for Schaefer deck organizers for wire applications. Special order please call Defender. (SS) = Stainless Steel. \*Indicates double stacked models

## LEWMAR 40MM DECK ORGANIZERS

All organizers have space to pass 2 lines between each sheave. Bushed sheaves. Stackable. Line size: 3/8" or 10mm. Tough interchangeable acetel or alloy sheaves.

Please Specify: 2, 3, 4, 5 or 6 sheave  
Item 608515

Starting at \$42.99



## LEWMAR DC1 ROPE CLUTCHES

The only true clutch that can be released under load due to its unique variable geometry handle and domino grip pattern.

• SWL: 1100 lbs • Color: Black



Item	Model	Configuration	Rope Size (mm)	Ship	Net
615721	29101108BK	Single	1/4" - 5/16" (6-8)	1 lbs	\$68.99
	29101110BK	Single	5/16" - 3/8" (8-10)	1 lbs	68.99
	29101112BK	Single	3/8" - 1/2" (10-12)	1 lbs	68.99
615722	29101208BK	Double	1/4" - 5/16" (6-8)	2 lbs	118.99
	29101210BK	Double	5/16" - 3/8" (8-10)	2 lbs	118.99
	29101212BK	Double	3/8" - 1/2" (10-12)	2 lbs	118.99
615723	29101308BK	Triple	1/4" - 5/16" (6-8)	2 lbs	169.99
	29101310BK	Triple	5/16" - 3/8" (8-10)	2 lbs	169.99
	29101312BK	Triple	3/8" - 1/2" (10-12)	2 lbs	169.99

Note: Uses 1/4" pan head mounting screws (Not included).

## LEWMAR DC2 ROPE CLUTCHES

For high load applications on boats to 55'. Hole spacing: 1.2" x 4.25"

• Can ease line a little without chafing its cover or release it entirely  
• Multi-point rope gripping surface treats halyards and sheets gently yet allows no slip  
• SWL: 2650 lbs • Color: Black



Item	Model	Configuration	Rope Size (mm)	Ship	Net
615724	29101410BK	Single	5/16" - 3/8" (8-10)	2 lbs	\$92.99
	29101412BK	Single	3/8" - 1/2" (10-12)	2 lbs	92.99
	29101414BK	Single	1/2" - 9/16" (12-14)*	2 lbs	92.99
615725	29102410BK	Double	5/16" - 3/8" (8-10)	3 lbs	164.99
	29102412BK	Double	3/8" - 1/2" (10-12)	3 lbs	164.99
	29102414BK	Double	1/2" - 9/16" (12-14)	3 lbs	164.99
615726	29103410BK	Triple	5/16" - 3/8" (8-10)	4 lbs	237.99
	29103412BK	Triple	3/8" - 1/2" (10-12)	4 lbs	237.99
	29103414BK	Triple	1/2" - 9/16" (12-14)	4 lbs	237.99

Note: Uses 5/16" pan head fasteners (not included). \*9/16" Line will only fit if core is slightly tapered. There is still a strong possibility of chafe with 9/16" line once in clutch.

## SPINLOCK MID-SIZE BOAT SHEAVE DECK ORGANIZER

Fiber composite moldings with stainless steel wear strip. Lead multiple lines back from the mast to banks of clutches or jammers. Minimal overall length. Efficient bearing reduces winch effort and increases halyard life. Modular end fairings for safe side loading. Can "Stack" for limited deck area or adding extra capacity. Designed to follow the curve of the deck when fitted.

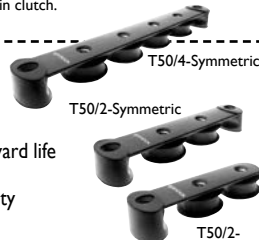

Item	Model	Sheaves	Style	Line Dia.	SWL per sheave	Ship	Net
615376	T50/2	2	Symmetric	Up to 9/16"	2200 lbs	1 lbs	\$49.99
615377	T50/2Y	2	Asymmetric	Up to 9/16"	2200 lbs	1 lbs	49.99
615378	T50/3	3	Symmetric	Up to 9/16"	2200 lbs	1 lbs	66.99
615379	T50/3Y	3	Asymmetric	Up to 9/16"	2200 lbs	1 lbs	66.99
615380	T50/4	4	Symmetric	Up to 9/16"	2200 lbs	1 lbs	83.99
615381	T50/4Y	4	Asymmetric	Up to 9/16"	2200 lbs	1 lbs	83.99
615382	T50/5	5	Symmetric	Up to 9/16"	2200 lbs	1 lbs	98.99
615383	T50/5Y	5	Asymmetric	Up to 9/16"	2200 lbs	1 lbs	98.99
615384	T50/6	6	Symmetric	Up to 9/16"	2200 lbs	1 lbs	120.99
615385	T50/6Y	6	Asymmetric	Up to 9/16"	2200 lbs	1 lbs	120.99

## SPINLOCK T25 SMALL BOAT DECK ORGANIZER

Proven fiber-reinforced construction. Stainless steel "wear" strip prevents local rope damage. Secure stainless steel unlinked base for fitting on non flat surfaces - simplifies deck sealing. Double stack with BE10 (sold separately) for lowest cost stacked line solution.



Item	Model	Sheaves	Style	Line Dia.	SWL per sheave	Ship	Net
606387	T25/2	2	Symmetric	Up to 3/8"	880 lbs	1 lbs	\$30.99
606388	T25/2Y	2	Asymmetric	Up to 3/8"	880 lbs	1 lbs	30.99
606389	T25/3	3	Symmetric	Up to 3/8"	880 lbs	1 lbs	36.99
606390	T25/3Y	3	Asymmetric	Up to 3/8"	880 lbs	1 lbs	36.99
606391	T25/4	4	Symmetric	Up to 3/8"	880 lbs	1 lbs	42.99
606392	T25/4Y	4	Asymmetric	Up to 3/8"	880 lbs	1 lbs	42.99
606393	T25/5	5	Symmetric	Up to 3/8"	880 lbs	1 lbs	54.99
606394	T25/5Y	5	Asymmetric	Up to 3/8"	880 lbs	1 lbs	54.99
606395	T25/6	6	Symmetric	Up to 3/8"	880 lbs	1 lbs	65.99
606396	T25/6Y	6	Asymmetric	Up to 3/8"	880 lbs	1 lbs	65.99

## SPINLOCK DOUBLE BULLS EYE FOR LEADING LINES

Versatile new solution for low load lines, either fitted alone or double stacking onto T25 organizers. Successful bulls-eye (BE) stainless steel eye construction.



Item	Model	Line Eyes	Rope Range	SWL	Ship	Net
606385	BE10/2	2	Up to 3/8"	880 lbs	1 lbs	\$9.99
606386	BE10/3	3	Up to 3/8"	880 lbs	1 lbs	10.99

# Shackles

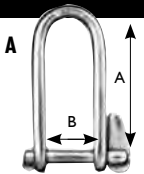

## WICHARD SHACKLES

**A. WICHARD KEY PIN SHACKLE** All ship 1 lbs.

Item	Model	Pin Dia.	A	B	SWL lbs	Net
608840	1432	3/16"	1-7/16"	1/2"	880	\$22.99
	1433	1/4"	1-3/4"	5/8"	1144	27.99
	1434	5/16"	2-5/16"	27/32"	1760	44.99

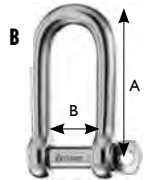

**B. WICHARD SELF-LOCKING LONG SHACKLE** All ship 1 lbs.

Item	Model	Dia.	A	B	SWL lbs	Net
608841	1211	5/32"	7/8"	5/16"	704	\$13.99
	1212	3/16"	1-5/32"	13/32"	880	16.99
	1213	1/4"	1-5/16"	15/32"	1320	20.99
	1214	5/16"	1-25/32"	5/8"	2200	26.99
	1215	13/32"	2-5/32"	25/32"	3344	41.99

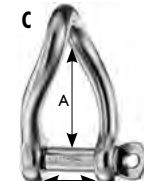

**C. WICHARD SELF-LOCKING TWISTED SHACKLE** All ship 1 lbs.

Item	Model	Dia.	A	B	SWL lbs	Net
608842	1222	3/16"	1-1/32"	13/32"	1056	\$19.99
	1223	1/4"	1-3/16"	15/32"	1320	21.99
	1224	5/16"	1-9/16"	5/8"	2200	28.99
	1225	13/32"	2"	25/32"	3168	43.99



**D. WICHARD SELF-LOCKING BOW SHACKLE**

Item	Model	Dia.	A	B	SWL lbs	Ship	Net
608843	1241	5/32"	11/16"	5/16"	704	1 lbs	\$14.99
	1242	3/16"	29/32"	13/32"	880	1 lbs	15.99
	1243	1/4"	1-3/32"	15/32"	1320	1 lbs	19.99
	1244	5/16"	1-15/32"	5/8"	2200	1 lbs	25.99
	1245	13/32"	1-27/32"	25/32"	3344	1 lbs	38.99
	1246	15/32"	2-1/8"	15/16"	4576	1 lbs	60.99
	1247	5/8"	2-3/4"	1-1/4"	7040	2 lbs	150.99
	1248	25/32"	3-5/32"	1-9/16"	8800	3 lbs	246.99

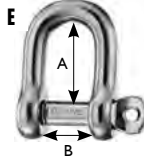

**E. WICHARD SELF-LOCKING D SHACKLE** All ship 1 lbs.

Item	Model	Dia.	A	B	SWL lbs	Net
608844	1201	5/32"	17/32"	5/16"	704	\$11.99
	1202	3/16"	5/8"	13/32"	880	13.99
	1203	1/4"	25/32"	15/32"	1320	16.99
	1204	5/16"	1-1/32"	5/8"	2200	23.99
	1205	13/32"	1-5/16"	25/32"	3344	33.99
	1206	15/32"	1-17/32"	15/16"	4576	56.99

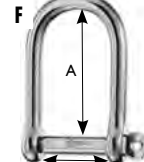

**F. WICHARD SELF-LOCKING LARGE OPENING SHACKLE** All ship 1 lbs.

Item	Model	Dia.	A	B	SWL lbs	Net
608795	1262	3/16"	1-13/32"	25/32"	563	\$22.99
	1263	1/4"	1-21/32"	1"	704	26.99
	1264	5/16"	2-1/4"	1-1/4"	1689	38.99
	1265	13/32"	2-13/16"	1-9/16"	2816	57.99

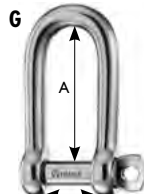

**G. WICHARD CAPTIVE PIN LONG D SHACKLE** Pin is connected to body. All ship 1 lbs.

Item	Model	Dia.	A	B	SWL lbs	Net
608845	1411	5/32"	1-7/32"	5/16"	704	\$20.99
	1412	3/16"	1-17/32"	13/32"	1056	22.99
	1413	1/4"	1-13/16"	15/32"	1496	27.99
	1414	5/16"	2-7/16"	5/8"	2200	40.99
	1415	13/32"	3-1/16"	25/32"	3344	63.99

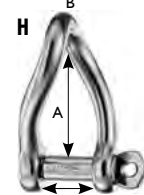

**H. WICHARD CAPTIVE PIN TWIST SHACKLE** Pin is connected to body. All ship 1 lbs.

Item	Model	Dia.	A	B	SWL lbs	Net
608846	1422	3/16"	1-15/32"	13/32"	1056	\$24.99
	1423	1/4"	1-3/4"	15/32"	1320	29.99
	1424	5/16"	2-5/16"	5/8"	2200	43.99
	1425	13/32"	2-15/16"	25/32"	3344	67.99

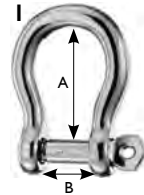

**I. WICHARD CAPTIVE PIN BOW SHACKLE** Pin is connected to body. All ship 1 lbs.

Item	Model	Dia.	A	B	SWL lbs	Net
608847	1441	5/32"	11/16"	5/16"	704	\$19.99
	1442	3/16"	29/32"	13/32"	1056	21.99
	1443	1/4"	1-1/16"	15/32"	1320	25.99
	1444	5/16"	1-15/32"	5/8"	2200	34.99
	1445	13/32"	1-13/16"	25/32"	3344	52.99

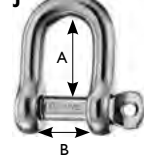

**J. WICHARD CAPTIVE PIN D SHACKLE** Pin is connected to body. All ship 1 lbs.

Item	Model	Dia.	A	B	SWL lbs	Net
608848	1401	5/32"	1/2"	5/16"	704	\$18.99
	1402	3/16"	5/8"	13/32"	1056	20.99
	1403	1/4"	25/32"	15/32"	1496	24.99
	1404	5/16"	1-1/32"	5/8"	2200	32.99
	1405	13/32"	1-5/16"	25/32"	3344	48.99

## SUNCOR SHACKLES

316 grade stainless steel. All ship 1 lbs. unless noted.

**K. SUNCOR STRAIGHT D SHACKLE WITH CAPTIVE PIN**

Item	Model	Dia.	SWL lbs	Net
608321	S0115-CP05	3/16"	500	\$6.99
	S0115-CP06	1/4"	750	8.99
	S0115-CP08	5/16"	1000	10.99
	S0115-CP10	3/8"	1200	18.99
	S0115-CP12	1/2"	1500	31.99

**L. SUNCOR LONG D SHACKLE WITH CAPTIVE PIN**

Item	Model	Dia.	SWL lbs	Net
608323	S0138-CP04	5/32"	200	\$6.99
	S0138-CP05	3/16"	500	7.99
	S0138-CP06	1/4"	750	7.99
	S0138-CP08	5/16"	1000	10.99
	S0138-CP10	3/8"	1200	16.99
	S0138-CP12	1/2"	1500	31.99

**M. SUNCOR BOW SHACKLE WITH SCREW PIN**

Item	Model	Dia.	SWL lbs	Net
003004	S0116-0005	3/16"	500	\$4.99
	S0116-0006	1/4"	750	5.99
	S0116-0008	5/16"	1000	6.99
	S0116-0010	3/8"	1200	13.99
	S0116-0012	15/32"	1500	18.99
	S0116-0013	1/2"	2500	25.99
	S0116-0016	5/8"	3000	25.99
	S0116-0020	3/4"	4000	49.99
	S0116-0022	7/8"	5000	58.99

**N. SUNCOR STRAIGHT D-SHACKLE**

Item	Model	Dia.	SWL lbs	Ship	Net
612396	S0115-0004	5/32"	200	1 lbs	\$1.99
	S0115-0005	3/16"	500	1 lbs	3.49
	S0115-0006	1/4"	750	1 lbs	3.49
	S0115-0008	5/16"	1000	1 lbs	3.99
	S0115-0010	3/8"	1200	1 lbs	5.99
	S0115-0012	15/32"	1500	1 lbs	12.99
	S0115-0013	1/2"	2500	1 lbs	19.99
	S0115-0016	5/8"	3000	1 lbs	25.99
	S0115-0020	3/4"	4000	2 lbs	39.99
	S0115-0022	7/8"	5000	3 lbs	59.99
	S0115-0025	1"	6000	4 lbs	94.99
	S0115-0032	1-1/4"	9000	9 lbs	169.99

For twist shackles visit [www.defender.com](http://www.defender.com)

## HAYN SHAKE PROOF HI-MOD SHACKLES

All Hayn shackles below are made from 316 grade stainless steel.

**O. HAYN HI-MOD D SHACKLE**

Item	Model	Dia.	MBL lbs	Net
615423	HM-D05RS	3/16"	3300	\$12.99
	HM-D06RS	1/4"	4290	14.99
	HM-D08RS	5/16"	6600	17.99
	HM-D10RS	3/8"	10560	27.99
	HM-D11RS	7/16"	13200	44.99
	HM-D12RS	1/2"	16500	48.99
	HM-D16RS	5/8"	22000	111.99

**P. HAYN HI-MOD LONG D SHACKLE**

Item	Model	Dia.	MBL lbs	Net
615424	HM-LD05RS	3/16"	2640	\$14.99
	HM-LD06RS	1/4"	3520	17.99
	HM-LD08RS	5/16"	5820	22.99
	HM-LD10RS	3/8"	8360	31.99

**Q. HAYN HI-MOD BOW SHACKLE**

Item	Model	Dia.	MBL lbs	Net
615425	HM-B05RS	3/16"	2640	\$13.99
	HM-B06RS	1/4"	3520	15.99
	HM-B08RS	5/16"	5280	21.99
	HM-B10RS	3/8"	8360	28.99
	HM-B11RS	7/16"	10560	32.99
	HM-B12RS	1/2"	13200	49.99
	HM-B16RS	5/8"	17600	113.99

**R. HAYN HI-MOD TWIST SHACKLE**

Item	Model	Dia.	MBL lbs	Net
615426	HM-T05RS	3/16"	2640	\$15.99
	HM-T06RS	1/4"	3520	17.99
	HM-T08RS	5/16"	5280	23.99
	HM-T10RS	3/8"	8360	31.99
	HM-T11RS	7/16"	10560	36.99
	HM-T12RS	1/2"	13200	45.99
	HM-T16RS	5/8"	17600	107.99

**S. HAYN HI-MOD LONG TWIST SHACKLE**

Item	Model	Dia.	MBL lbs	Net
615427	HM-LT05RS	3/16"	2640	\$17.99
	HM-LT06RS	1/4"	3520	19.99
	HM-LT08RS	5/16"	5820	25.99
	HM-LT10RS	3/8"	8360	36.99





**A. RONSTAN FIXED BAIL SNAP SHACKLES**

Investment cast 15-5 PH stainless steel alloy. Ship 1 lbs.

Item	Model	Length	Bail I.D.	Jaw I.D.	MWL	BL	M.A.P.
601195	RF6080	1-1/4"	3/16"	1/4"	165 lbs	330 lbs	\$18.95
602397	RF6200	3-11/32"	3/4"	1"	2420 lbs	4840 lbs	61.95

Note: Line size is for standard double braids. Hi-tech lines may require increased shackle size based on working loads.

**B. RONSTAN SMALL SWIVEL BAIL SNAP SHACKLES**

Investment cast 15-5 PH stainless steel alloy. Standard compact swivel. For halyards and sheets. All ship 1 lbs.

Item	Model	Length	Bail I.D.	Jaw I.D.	MWL	BL	M.A.P.
602388	RF6110	2-23/32"	3/8"	5/8"	1870 lbs	3750 lbs	\$54.95
602389	RF6111*	2-3/4"	3/8"	5/8"	1650 lbs	3310 lbs	84.95
602398	RF6210	3-5/8"	5/8"	5/8"	3530 lbs	7050 lbs	71.95
602407	RF6310	4-11/32"	5/8"	1-1/32"	3970 lbs	7940 lbs	101.95

\* Trunnion, for use when two plane articulation is needed.

**C. RONSTAN LARGE SWIVEL BAIL SNAP SHACKLES**

Investment cast 15-5 PH stainless steel alloy. Large bail (FR) - Large swivel. For spinnaker sheets and guys. All ship 1 lbs.

Item	Model	Length	Bail I.D.	Jaw I.D.	MWL	BL	M.A.P.
602390	RF6120	2-7/8"	1/2"	5/8"	1650 lbs	3310 lbs	\$56.95
602400	RF6220	3-31/32"	1"	5/8"	2430 lbs	4850 lbs	81.85
602411	RF6321*	4-13/16"	1-1/32"	1-1/32"	2980 lbs	5950 lbs	127.95
602410	RF6320	4-3/4"	1-1/32"	1-1/32"	2980 lbs	5950 lbs	100.95

\* Trunnion, for use when two plane articulation is needed.

**D. RONSTAN SCREW PIN SNAP SHACKLE**

Investment cast 15-5 PH stainless steel alloy. Tack bail (P) - Swivel shackle with removable pin. For jib and staysail tacks. All ship 1 lbs.

Item	Model	Length	Pin Dia.	Jaw I.D.	Jaw Width	MWL	M.A.P.
602392	RF6130	2-27/32"	1/4"	5/8"	1/2"	1650 lbs	\$62.95



**J. WICHARD SWIVEL EYE SNAP SHACKLES**

Hot drop forged from a high resistance stainless steel. All ship 1 lbs.

Item	Model	Length	Bail I.D.	Jaw I.D.	SWL	Net
607648	2473	2-3/4"	7/16"	5/8"	2112 lbs	\$57.99
607649	2475	3-1/2"	9/16"	13/16"	2816 lbs	67.99
607650	2477	4-3/4"	1-3/16"	1-1/32"	6160 lbs	130.99

**K. WICHARD LARGE BAIL SNAP SHACKLES**

Hot drop forged from a high resistance stainless steel. All ship 1 lbs.

Item	Model	Length	Bail I.D.	Jaw I.D.	SWL	Net
607651	2373	3-1/8"	3/4"	5/8"	2112 lbs	\$63.99
607652	2375	4-1/8"	1-3/32"	13/16"	2816 lbs	88.99
607653	2377	5-1/2"	1-3/8"	1-3/8"	6160 lbs	136.99

**L. WICHARD QUICK RELEASE SHACKLES "HR" WITH SWIVEL EYE** All ship 1 lbs.

Item	Model	Length	Bail I.D.	Jaw I.D.	SWL	Net
607581	2673	2-3/4"	7/16"	35/64"	1936 lbs	\$68.99
607582	2674	3-5/32"	15/32"	5/8"	2816 lbs	86.99
607583	2675	3-35/64	17/32"	25/32"	3520 lbs	105.99
607584	2676	4-21/64"	5/8"	63/64"	5280 lbs	136.99
607585	2677	5-1/8"	25/32	1-3/16"	7040 lbs	211.99
607586	2678	5-29/32"	15/16"	1-11/32"	11,440 lbs	355.99

**M. WICHARD QUICK RELEASE SHACKLES "HR" WITH LARGE BAIL** All ship 1 lbs.

Item	Model	Length	Bail I.D.	Jaw I.D.	SWL	Net
607587	2773	3-5/32"	3/4"	35/64"	1936 lbs	\$75.99
607588	2774	3-35/64	29/32"	5/8"	2816 lbs	93.99
607589	2775	4-21/64"	1-3/64"	25/32"	3520 lbs	113.99
607590	2776	4-23/32"	1-7/32	63/64"	5280 lbs	144.99
607591	2777	5-45/64"	1-25/64"	1-3/16"	6160 lbs	225.99
607592	2778	6-19/64"	1-39/64"	1-11/32"	11,440 lbs	374.99

**N. WICHARD SNAP SHACKLES WITH CLEVIS PIN**

Hot drop forged from a high resistance stainless steel. All ship 1 lbs.

Item	Model	Length	Bail I.D.	Jaw I.D.	SWL	Net
607654	2474	2-3/4"	15/32"	5/8"	1760 lbs	\$58.99
607655	2476	3-35/64"	7/16"	53/64"	2816 lbs	79.99
607656	2478	4-23/32"	45/64"	1-1/32"	5280 lbs	145.99

Note: Wichard measurements have been converted to imperial and are approximate and not independently verified

**E. SCHAEFER SWIVEL SNAP SHACKLES** Stainless steel line bail. All ship 1 lbs.

Item	Model	Length	Bail I.D.	Jaw Length	Jaw I.D.	Working Load	Net
602883	45-01	2-25/32"	7/16"	15/16"	3/4"	2250 lbs	\$95.99
602884	45-05	3-17/32"	9/16"	1-3/16"	15/16"	3750 lbs	100.99
602885	45-10	4-3/8"	3/4"	1-1/4"	1-9/32	5000 lbs	134.99

**F. SCHAEFER TACK SNAP SHACKLES** Stainless steel clevis pin. All ship 1 lbs.

Item	Model	Length	Bail I.D.	Clip Length	Clip Width	Jaw I.D.	Jaw Length	Working Load	Net
602887	45-21	3-1/32"	7/16"	19/32"	1/4"	15/16"	3/4"	2250 lbs	\$91.99
602888	45-25	3-21/32"	9/16"	17/32"	9/16"	15/16"	1-3/16"	3750 lbs	102.99
602889	45-30	4-21/32"	3/4"	27/32"	3/4"	1-1/4"	1-9/32	5000 lbs	129.99

**G. WICHARD FIXED EYE SNAP SHACKLES**

Hot drop forged from a high resistance stainless steel. All ship 1 lbs.

Item	Model	Length	Bail I.D.	Jaw I.D.	SWL	Net
607645	2470	1-3/8"	1/4"	5/16"	352 lbs	\$39.99
607646	2471	2"	3/8"	5/8"	2112 lbs	44.99
607647	2472	2-3/4"	1/2"	13/16"	2816 lbs	65.99

**H. TYLASKA SNAP SHACKLES** Stainless steel with slotted head. All ship 2 lbs.

Item	Model	Length	Bail Size	Jaw Size	Working Load	Net
608997	TY1005-S	2-15/16"	9/16"	9/16"	2500 lbs	\$135.99
	TY1005-L	3-5/16"	7/8"	9/16"	2500 lbs	138.99
	TY1008-S	3-7/16"	21/32"	11/16"	4000 lbs	142.99
	TY1008-L	3-5/8"	1"	11/16"	4000 lbs	149.99
	TY1012-S	4"	3/4"	3/4"	6000 lbs	159.99
	TY1012-L	4-1/2"	1-3/16"	3/4"	6000 lbs	167.99
	TY1020-S	5"	15/16"	15/16"	10000 lbs	221.99

**I. SUNCOR SWIVEL SNAP SHACKLES** Corrosion resistant 316 stainless steel. All ship 1 lbs.

Item	Model	Length	Bail I.D.	Jaw I.D.	Working Load	Net
608919	S0157-0001	2-3/4"	1/2"	57/100"	1000 lbs	\$16.99
	S0157-0002	3-1/2"	5/8"	3/4"	1500 lbs	20.99
	S0157-0003	5"	1-7/50"	1-1/20"	2000 lbs	34.99

**I. SUNCOR FIXED SNAP SHACKLE** Corrosion resistant 316 stainless steel. All ship 1 lbs.

605823*	S0158-0002	2-5/8"	1/2"	3/4"	1500 lbs	\$11.99
---------	------------	--------	------	------	----------	---------

\*Close-out!



**O. WICHARD KEY PIN SHACKLE WITH BAR** All ship 1 lbs.

Item	Model	Pin Dia.	A	B	C	SWL	Net
607550	81432	3/16"	1-7/16"	1/2"	15/32"	880	\$29.99
607551	81433	1/4"	1-3/4"	5/8"	19/32"	1144	34.99
607552	81434	5/16"	2-5/16"	27/32"	25/32"	1760	53.99

**P. RONSTAN KEY PIN HALYARD SHACKLES** All ship 1 lbs.

Item	Model	Pin Size	Jaw Width	PLBL*	Max Line	M.A.P.
601741	RF1032	3/16"	19/32"	1980 lbs	3/8"	\$17.95
601742	RF1033	1/4"	3/4"	3310 lbs	1/2"	19.95
601743	RF1034	5/16"	25/32"	4850 lbs	11/16"	26.95

\*Ultimate break load is higher than point load.

**Q. WICHARD THIMBLE SHACKLES** All ship 1 lbs.

Available with captive pin (1494/1495) or flush allen head pin (1394/1395). Snag-free.

Item	Model	Pin Dia.	Width	Max. Line	SWL	Net
613310	1494	5/16"	5/8"	1/2"	2200 lbs	\$52.99
613276	1394	5/16"	5/8"	1/2"	2200 lbs	60.99
613872	1495	13/32"	25/32"	5/8"	3344 lbs	81.99
613277	1395	13/32"	25/32"	5/8"	3344 lbs	91.99

**R. WICHARD SOFTLINKS** All ship at 1 lbs.

A soft, lightweight shackle for recreational sailors looking for performance and ease of use.

Item	Model	Breaking Load	Loop Dia.	Loop Length	Net
608879	21223	5291 lbs	3 mm	70 mm	\$30.99
	21224	7275 lbs	4 mm	80 mm	41.99
	21225	11,023 lbs	5 mm	90 mm	52.99

**MARLOW DYNEEMA SK78 SOFT SHACKLES**

- Select line diameter and color
- Please specify Black or Red
- Sold in pairs

Item	Breaking loads	Starting at
607708	2060 kg to 6940 kg	\$20.99

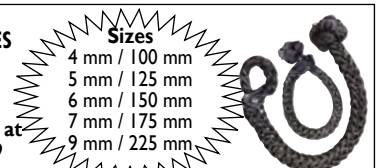

# LEWMAR

These pages show only some of the winches that Defender offers. Please inquire for the best delivery and pricing on the larger models: 3-speed winches, electric winches, hydraulic drive systems, gear boxes and custom winches. Aluminum drums are heat-treated and anodized, typically for racing, and are extremely lightweight. Chrome-plated bronze drums, most common for cruising, are rugged and suitable for all uses. Polished bronze drums provide classic styling. Stainless steel drums provide extra durability and weather resistance. For more information contact: Lewmar, 800-362-7212 or visit [www.defender.com/lewmar](http://www.defender.com/lewmar).

## Lewmar EVO Electric Self-Tailing Winch Kits

A 12 Volt DC self-tailing winch that works with the push of a button! This Lewmar electric winch is fitted with a series-wound motor allowing the sheet to be recovered rapidly at low load when sheets are slacker, and slows down as the load increases. This provides speed when you need it most, and control as you tune your sails to perfection, precluding the need for a 2-speed winch motor. Chrome finish and alloy finish are also available.



- Includes:
- Deck unit
  - Motor gearbox
  - Circuit breaker
  - Deck switch
  - Pre-mounted E-Series controller
  - 7 year warranty
  - 1 year warranty on electrical components

Item	Model	Finish	Base Dia.,"	Height,"	Control Type	Ship	Net
602213	40EST	Chrome	6-1/16	6-9/10	E	51 lbs	\$2299.99
607419	40EST	Chrome	6-1/16	6-9/10	ELS	51 lbs	2334.99
615664	45EST	Chrome	6-55/64	7-5/8	E	52 lbs	2489.99
607421	45EST	Chrome	6-55/64	7-5/8	ELS	60 lbs	2334.99
607420	45EST	Black alum.	6-55/64	7-5/8	ELS	53 lbs	2267.99
615665	50EST	Chrome	7-21/64	9-2/3	E	68 lbs	3026.99
607423	50EST	Chrome	7-21/64	9-2/3	ELS	68 lbs	4056.99
607422	50EST	Black alum.	7-21/64	9-2/3	ELS	60 lbs	3893.99
615666	55EST	Chrome	8-1/4	10-1/8	ELS	77 lbs	4437.99

## Lewmar EVO Manual Winches



The EVO winch was developed based on years of knowledge and understanding of what boat builders and sailors want. No compromises have been made in terms of quality or integrity of design.

- Convertible to electric • 7 year warranty
- More models and conversion kits available at [www.defender.com](http://www.defender.com)

BLACK OR GRAY ALLOY (Please Specify)

Item	Model	Speed	Gear Ratio	Base Dia.,"	Line Size"	Ship	Net
615297	15ST	1	2:1	4-3/4"	5/16-1/2	7 lbs	\$496.99
615299	30ST	2	2:1/4.2:1	5-7/16	5/16-1/2	10 lbs	766.99
615301	40ST	2	1.9:1/5.8:1	5-13/16	5/16-1/2	12 lbs	924.99
615303	45ST	2	2.4:1/7.6:1	6-5/8	5/16-9/16	17 lbs	1249.99
615305	50ST	2	2.6:1/9:1	7-1/8	5/16-9/16	21 lbs	1588.99
615307	55ST	2	2.8:1/11.2:1	8-1/16	5/16-5/8	29 lbs	2247.99
615309	65ST	2	3.1:1/14.8:1	9	5/16-1/16	36 lbs	2674.99

### CHROMED BRONZE

Item	Model	Speed	Gear Ratio	Base Dia.,"	Line Size"	Ship	Net
615298	15ST	1	2:1	4-3/4	5/16-1/2	9 lbs	\$553.99
615300	30ST	2	2:1/4.2:1	5-7/16	5/16-1/2	13 lbs	839.99
615302	40ST	2	1.9:1/5.8:1	5-13/16	5/16-1/2	15 lbs	995.99
615304	45ST	2	2.4:1/7.6:1	6-5/8	5/16-9/16	22 lbs	1320.99
615306	50ST	2	2.6:1/9:1	7-1/8	5/16-9/16	28 lbs	1766.99
615308	55ST	2	2.8:1/11.2:1	8-1/16	5/16-5/8	41 lbs	2460.99
615310	65ST	2	3.1:1/14.8:1	9	5/16-1/16	55 lbs	2923.99

Note: Winch sizes 40 and up can be easily upgraded to electric power.

## Lewmar Standard Winches

Time tested, high quality, hard-wearing line control solutions. Sizes 6 and 7 feature lightweight, glass-fiber reinforced composite stems. Sizes 8 and 16 feature bronze stems.

### ALUMINUM

Item	Size	Speed	Gear Ratio	Base Dia.,"	Ship	Net
606081	6	1	1:1	3-11/16	2 lbs	\$137.99
606084	7	1	1:1	4-1/4	2 lbs	189.99
606087	8	1	1:1	4-1/4	4 lbs	231.99
606090	16	2	1:1/2:1	4-3/4	6 lbs	420.99



Standard 6



Standard 8

### CHROME

Item	Size	Speed	Gear Ratio	Base Dia.,"	Ship	Net
606083	6	1	1:1	3-11/16	3 lbs	\$172.99
606086	7	1	1:1	4-1/4	4 lbs	222.99
606089	8	1	1:1	4-1/4	6 lbs	272.99
606092	16	2	1:1/2:1	4-3/4	8 lbs	477.99

### BRONZE

Item	Size	Speed	Gear Ratio	Base Dia.,"	Ship	Net
606082	6	1	1:1	3-11/16	3 lbs	\$172.99
606085	7	1	1:1	4-1/4	4 lbs	222.99
606088	8	1	1:1	4-1/4	5 lbs	272.99

## Lewmar Self-Tailing Ocean Series Winches

The "Wavespring" combines Lewmar's renowned and gentle wave grip feature with self-adjusting springs. It handles today's smaller diameter ropes as well as the traditional, larger Dacron composites. A sleek feeder arm design ensures absolute snag-free operation.



### ALUMINUM

Item	Model	Speed	Gear Ratio	Base Dia.,"	Line Size"	Ship	Net
614514	14ST	1	2:1	4-3/4	1/4-3/8	7 lbs	\$441.99
606105	16ST	1	2:1	4-3/4	5/16-1/2	8 lbs	547.99
606110	30ST	2	2:1/4.2:1	5-7/16	5/16-1/2	11 lbs	850.99
606115	40ST	2	1.9:1/5.8:1	5-13/16	5/16-1/2	12 lbs	1034.99
600046	46ST	2	2.4:1/7.6:1	6-5/8	5/16-9/16	18 lbs	1380.99
606127	48ST	2	2.6:1/9:1	7-1/8	5/16-9/16	22 lbs	1839.99
606133	50ST	2	2.8:1/10.5:1	7-7/8	5/16-5/8	27 lbs	2306.99

### CHROME

Item	Model	Speed	Gear Ratio	Base Dia.,"	Line Size"	Ship	Net
614515	14ST	1	2:1	4-3/4	1/4-3/8	9 lbs	\$474.99
606106	16ST	1	2:1	4-3/4	5/16-1/2	10 lbs	605.99
606111	30ST	2	2:1/4.2:1	5-7/16	5/16-1/2	14 lbs	923.99
606116	40ST	2	1.9:1/5.8:1	5-13/16	5/16-1/2	16 lbs	1133.99
600047	46ST	2	2.4:1/7.6:1	6-5/8	5/16-9/16	24 lbs	1524.99
606128	48ST	2	2.6:1/9:1	7-1/8	5/16-9/16	29 lbs	2040.99
606134	50ST	2	2.8:1/10.5:1	7-7/8	5/16-5/8	39 lbs	2490.99
606140	54ST	2	2.8:1/11.2:1	8-1/16	5/16-5/8	43 lbs	2732.99

### BRONZE

Item	Model	Speed	Gear Ratio	Base Dia.,"	Line Size"	Ship	Net
606107	16ST	1	2:1	4-3/4	5/16-1/2	11 lbs	\$644.99
606114	30ST	2	2:1/4.2:1	5-7/16	5/16-1/2	14 lbs	915.99
606120	40ST	2	1.9:1/5.8:1	5-13/16	5/16-1/2	17 lbs	1104.99
600048	46ST	2	2.4:1/7.6:1	6-5/8	5/16-9/16	24 lbs	1524.99
606132	48ST	2	2.6:1/9:1	7-1/8	5/16-9/16	29 lbs	2030.99
606138	50ST	2	2.8:1/10.5:1	7-7/8	5/16-5/8	39 lbs	2415.99

### STAINLESS STEEL

Item	Model	Speed	Gear Ratio	Base Dia.,"	Line Size"	Ship	Net
606119	40ST	2	1.9:1/5.8:1	5-13/16	5/16-1/2	17 lbs	\$1159.99
600049	46ST	2	2.4:1/7.6:1	6-5/8	5/16-9/16	23 lbs	1524.99
606131	48ST	2	2.6:1/9:1	7-1/8	5/16-9/16	28 lbs	2060.99
606137	50ST	2	2.8:1/10.5:1	7-7/8	5/16-5/8	40 lbs	2502.99

## Electric Conversion Kits



Kit provides a low-cost alternative to replacing a manual winch with an electric version. This option is achieved by the installation of a power drive unit, motor and switch gear. Kit includes drive unit, center stem, motor gearbox, deck switch and breaker. Kits for winches manufactured after June 2000.

Item	Model	Control	Description	Ship	Net
614502	480403001	E	For 40ST	35 lbs	\$1713.99
614503	480443001	E	For 44ST	43 lbs	1756.99
606982	480443002	ELS	For 44ST	45 lbs	2154.99
600057	480463001	E	For 46ST	45 lbs	1699.99
614504	480483001	E	For 48ST	46 lbs	1797.99
606983	480483002	ELS	For 48ST	46 lbs	2206.99
606980	480543001	ELS	For 54ST	61 lbs	2999.99
606985	480583001	ELS	For 58ST	64 lbs	3468.99

Note: Available for models up to size 65. Contact Lewmar (800)362-7212 for your model #.

## LEWMAR EVO WINCH ELECTRIC CONVERSION KIT

Contains all you need to convert your manual winch to an electric model

Specify Winch Size: 40, 45, 50 or 55  
Specify Contactor Type: ELS (Electric load sensing) or E (Thermal trip)  
Item 608396 Prices starting at \$1716.99

## Antal Snubbing and Standard Winches

### PLASTIC SNUBBING

Snubbing winch made of high strength glass fiber. Does not have winch handle capacity. Great for davit and hoisting applications

Item	Model	Speed	Base Dia.,"	Ship	Net
608993	W5	1	80 mm	1 lbs	\$54.99



W5

### NYLON SNUBBING

Size 6 Standard winch. Smallest and lightest composite winch with a 6:1 ratio.

Item	Model	Speed	Base Dia.,"	Ship	Net
608994	W6	1	94 mm	1 lbs	\$79.99



W6

### ALUMINUM STANDARD

Size 7 Standard winch. Black Aluminum anodized finish with a 7:1 ratio

Item	Model	Speed	Base Dia.,"	Ship	Net
608995	W7	1	97 mm	2 lbs	\$129.99



W7



Some manufacturers set M.A.P. (Minimum Advertised Pricing) for their products, so we cannot advertise a lower price. However, this does not always apply to selling price. The actual price you will be charged is probably lower. Please call us at 800-628-8225 for further details.



## Lewmar Winch Maintenance & Spare Kits

**GRAY JAW KITS** Includes stripper ring, appropriate number of springs and cups

Item	Model/Description	Ship	Net
615285	48000447 for 14ST - 16ST	1 lbs	\$42.99
615260	48000448 for 28ST - 30ST	1 lbs	41.99
601229	48000449 for 34 - 40ST	1 lbs	35.99
615259	48000450 for 44ST - 46ST	1 lbs	53.99
615294	48000451 for 48ST	1 lbs	59.99
615295	48000452 for 50ST - 54ST	1 lbs	87.99

### SINGLE SPEED MAINTENANCE KIT

608877	48000014 for STD 6-40ST 14,15,16	1 lbs	\$37.99
--------	----------------------------------	-------	---------

### TWO SPEED MAINTENANCE KIT

608878	48000019 for ST30-48 and EVO 30-50	1 lbs	\$31.99
--------	------------------------------------	-------	---------

### THREE SPEED MAINTENANCE KIT

606871	19700300 See www.defender.com for contents	1 lbs	\$111.99
--------	--------------------------------------------	-------	----------

### WINCH GEAR GREASE

606875	19701000 100 g tube	1 lbs	\$17.99
--------	---------------------	-------	---------

### RACE LUBE

606878	19701600 55 ml	1 lbs	\$10.99
--------	----------------	-------	---------

## ANDERSEN FULL STAINLESS SELF-TAILING WINCHES



The exclusive self-tailing mechanism automatically accommodates a wide range of different sheet and halyard sizes allowing each winch to serve numerous onboard tasks. The exclusive stainless steel Power Rib™ drum uses vertical ribs to firmly grip the line, requiring fewer turns on the drum. The drum's smooth surface is corrosion free and far less abrasive to your sheets and halyards extending the life of your lines.



Item	Model	Line Size	Drum Dia.	Base Dia.	Ht.	Ship	Net
608930	12ST	5/16"-9/16"	2-3/4"	4-1/2"	5"	6 lbs	\$429.99
	18ST	5/16"-9/16"	2-3/4"	4-3/4"	5-1/4"	8 lbs	539.99
	28ST	5/16"-9/16"	2-3/4"	4-15/16"	5-13/16"	10 lbs	769.99
	34ST	5/16"-9/16"	2-3/4"	4-15/16"	5-13/16"	11 lbs	869.99
	40ST	5/16"-9/16"	2-15/16"	6"	6-13/16"	12 lbs	949.99
	46ST	5/16"-9/16"	3-1/2"	7-1/16"	7-15/16"	16 lbs	1349.99
	50ST	5/16"-9/16"	3-1/2"	7-1/16"	7-15/16"	18 lbs	1499.99
	52ST	5/16-5/8"	3-15/16"	7-7/8"	8-11/16"	23 lbs	2199.99
614993	58ST	5/16-11/16"	4-1/2"	9-1/16"	9-7/8"	36 lbs	2899.99

## ANDERSEN STANDARD STAINLESS STEEL WINCHES

Features Power Rib drum for winching in all conditions. Drop ship only.

Item	Size	Spds.	Drum Dia.	Base Dia.	Ht.	Ship	Net
608366	10	1	2-1/4"	3-5/8"	3-1/2"	3 lbs	\$197.99
	28	2	2-3/4"	4-7/8"	4-15/16"	8 lbs	699.99
	40	2	3"	5-3/8"	5-1/2"	9 lbs	766.99
	46	2	3-1/16"	5-5/8"	5-1/2"	10 lbs	813.99



## ANDERSEN WINCH GREASE

Regular maintenance will increase the life of your winch.

Andersen recommends cleaning their winches every two years.

Item 614605 2.7 oz. tube. Ship 1 lbs Net \$14.99



## HARKEN RADIAL SELF-TAILING MANUAL WINCHES

Designed for sailors who want lightweight, extremely strong winches with plenty of power. The gripping surface is shaped rather than textured, reducing line wear and providing maximum gripping power.



Larger models and electric versions available at www.defender.com

Item	Model	Gear Ratio	Base Dia.	Height	Line Sizes	Ship	Net
615501	20STC	2.76	5-3/8"	5-13/16"	1/4"-1/2"	8 lbs	\$612.99
615502	35.2STC	2.13: 5.65	5-7/8"	6-11/16"	5/16"-1/2"	11 lbs	864.99
615503	40.2STC	2.13: 6.28	6-3/16"	6-7/8"	5/16"-1/2"	12 lbs	987.99
615504	46.2STC	2.30: 9.17	7-1/4"	7-15/16"	5/16"- 9/16"	19 lbs	1441.99
615505	50.2STC	2.40: 10.90	7-5/8"	8-5/16"	5/16"- 9/16"	21 lbs	2090.99

## ALUMINUM

615563	15STA	2.43	4-3/4"	5-1/2"	3/8" Max	2 lbs	\$486.99
615512	20STA	2.76	5-3/8"	5-13/16"	1/4"-1/2"	3 lbs	540.99
615513	35.2STA	2.13: 5.65	5-7/8"	6-11/16"	5/16"-1/2"	4 lbs	792.99
615514	40.2STA	2.13: 6.28	6-3/16"	6-7/8"	5/16"-1/2"	4 lbs	901.99
615515	46.2STA	2.30: 9.17	7-1/4"	7-15/16"	5/16"- 9/16"	6 lbs	1225.99
615516	50.2STA	2.40: 10.90	7-5/8"	8-5/16"	5/16"- 9/16"	6 lbs	1910.99

## MARELON® MW-6 1-SPEED WINCH

- Handles up to 200 square feet of sail
- Great for davits
- Ultra-light weight- less than one pound
- Accepts standard star drive winch handle
- 8:1 Power ratio when used with a 10" handle
- 6:1 Power ratio when used with an 8" handle
- Requires: 4 x 1/4" fasteners



Item	Model	Speed	Drum Dia.	Base Dia.	Top Dia.	Height	Ship	Net
615130	960003	1	2-7/16"	3-5/8"	3-1/4"	3-3/8"	1 lbs	\$89.99

## WINCH MAINTENANCE PACK

Includes 100 g grease, 55 ml race lube, 10 pawl springs, brush, "How To" book.

Item	Model/Description	Ship	Net
606877	19701500	1 lbs	\$31.99

## BARIENT REPAIR KITS

602274	PK1 repair kit (2 pawls, 4 springs and 2 retaining rings)	1 lbs	\$28.99
602273	19712056 Barient winch replacement pawl springs	1 lbs	14.99
602185	BT00330 Barient winch replacement pawl	1 lbs	14.99

## WINCH SPARES

606873	19700501 Size: Small	1 lbs	\$43.99
606872	19700401 Size: Large	1 lbs	48.99

## REPLACEMENT STRIPPER RINGS

600956	4500008P For Lewmar 16ST / 14ST winches	1 lbs	\$19.99/pr.
600633	45000108P For Lewmar 30ST / 40ST winches	1 lbs	23.99/pr.
615296	15000375 For Lewmar 30ST / 40ST winches ('84-'89)	1 lbs	10.99 ea.
604486	45000308P For Lewmar 44ST / 46ST winches	1 lbs	28.99/pr.
601785	45000408P For Lewmar 48ST winches	1 lbs	31.99/pr.
600943	45000508P For Lewmar 50ST / 54ST winches	1 lbs	32.99/pr.

## ANDERSEN WINCH SERVICE KITS All Ship 1 lbs.

Item	Model	For Winches	Pawls	Springs	Bearings	Circlips	Screws	Washers	Retaining Ring	Locking Pin	Sealing Ring	Net
612042	RA 710001	12, 28, 40ST	•	•	•	•	•	•	•	•		\$38.99
612043	RA 710002	46ST	•	•	•	•	•	•	•	•		47.99
612044	RA 710003	56, 66ST	•	•	•	•	•	•	•	•	•	123.99
612045	RA 710004	10, 16, 28, 40, 46 Classic	•	•	•	•	•	•	•	•		52.99
612046	RA 710006	6, 10, 16, 28, 40, 46, 48 Classic	•	•	•	•	•	•	•	•		29.99
612047	RA 710008	52ST	•	•	•	•	•	•	•	•		70.99
612048	RA 710012	58, 62ST	•	•	•	•	•	•	•	•		82.99
612049	RA 710013	68, 72ST	•	•	•	•	•	•	•	•		81.99

## ANDERSEN WINCH REPLACEMENT DISC SPRING COVER

- Applications: Andersen 12ST and 28ST winches
- Includes: Disc spring cover

Item	Model	For Winch Model(s)	Ship	Net
606944	RA 726300	12ST, 28ST	1 lbs	\$21.99



## ANDERSEN WINCH REPLACEMENT DISC SPRING

- Applications: Anderson 40ST self-tailing manual winches
- Includes: Disc spring • Dimensions: O.D. 4.25", I.D. 2.36"

Item	Model	For Winch Model(s)	Ship	Net
615386	RA 535500	40ST	1 lbs	\$24.99



## BARTON SELF TAILER WINCHERS

Converts standard winches to self-tailing - Rubber disks that fit over the top of non-self-tailing winches to make them perform like self-tailers.

Item	Model	Size (Drum Dia.)	Ship	Net/Pair
600711	21 641	2-1/4 - 2-3/4"	1 lbs	\$54.99
600712	21 642	2-3/4 - 3"	1 lbs	58.99
600713	21 643	3 - 3-1/2"	1 lbs	62.99
600714	21 644	3-1/2 - 4"	1 lbs	66.99



## TEAK WINCH PADS

Item	Model	Type	Size	Ship	Net
650536	60164	Flat	4-1/2" x 1-1/4"	1 lbs	\$18.99
650541	60166	Flat	6-3/8" x 1-1/4"	2 lbs	31.99



## SELDÉN 5° WINCH PAD WITH INSULATING SHEET

- Fit all mast sections and are easy to install
- Each winch pad is labelled with instructions for fitting
- Each pad has a 5° angle to prevent override on the winch
- Well-rounded corners to avoid sail chafe



Item	Model	Dimensions	Working Load	Ship	Net
608859	523-041-01	110 mm x 110 mm	5 kN	1 lbs	\$79.99
	523-042-01	140 mm x 140 mm	10 kN	1 lbs	107.99
	523-044-01	180 mm x 180 mm	15 kN	1 lbs	189.99



## HARKEN WINCH GREASE & PAWL OIL

- Non-aging, highly adhesive synthetic lubricant
- Resistant to both salt and fresh water. Protects metal gears, roller bearings and all moving winch parts from corrosion and wear

Item	Model	Size	Ship	Net
600603	BK4513	Winch grease 3.5 oz	1 lbs	\$10.99
600604	BK4521	Pawl oil 2 oz	1 lbs	8.99



## WINCH SERVICE KIT

- Fits: Classic winches B6 - B980 and all radial winches
- Includes 10 pawls and 20 springs
- For routine maintenance of Harken winches

Item	600607	Model	BK4512	Ship	1 lbs	Net	\$28.99
------	--------	-------	--------	------	-------	-----	---------

## Winch Handles and Accessories

### LEWMAR ONETOUCH WINCH HANDLE

Patented "One Touch" Lock mechanism provides fast, easy one-handed operation. Just squeeze the release lever and pull to remove in one fast motion. To lock, simply squeeze and insert. This stylish and powerful handle is popular with both racers and cruisers.

- Release lever runs the entire length of the handle for easy access
- Lightweight forged alloy construction
- Corrosion resistant
- Easy one hand operation



Item	Model	Description	Ship	Net
612572	29140044	10" Single grip alloy	2 lbs	\$94.99
612573	29140046	10" Alloy power grip	2 lbs	89.99
600806	29140040	8" Single grip alloy	2 lbs	80.99
600807	29140042	8" Alloy power grip	2 lbs	84.99

### LEWMAR/TITAN FLOATING WINCH HANDLES

Item	Model	Description	Ship	Net
A 612537	29145301	8" Locking, Red	1 lbs	\$49.99
A 612549	29145311	10" Locking, Red	1 lbs	50.99

### LEWMAR WINCH HANDLES

Item	Model	Description	Ship	Net
B 606892	29141121	10" Chrome locking	3 lbs	\$94.99
C 606888	29141111	10" Aluminum locking	2 lbs	86.99
D 606894	29141122	10" Chrome locking, double grip	4 lbs	142.99

### LEWMAR WINCH HANDLE SPARES KIT

- Applications: 8" and 10" Lewmar locking handles
- Excludes Titan and OneTouch handles

Item	Model	Description	Ship	Net
606899	29140013	10" Lock-in spares kit	1 lbs	\$29.99

### HARKEN CARBO ONE TOUCH LOCKING WINCH HANDLE

Material: High-strength, fiber-reinforced composite (same as our carbo blocks) over an aluminum grip rod and forged aluminum handle to manage the bending stresses.

Item	Model	Description	Ship	Net
615561	B10HOT	9.5" Palm grip	2lbs	80.99

### SCHAEFER LOCKING WINCH HANDLES

- Forged aluminum, stainless ball bearing and composite grip

Item	Model	Description	Ship	Net
615144	WHL-10-D	10" Ball grip	2 lbs	\$79.99
615097	WHL-10-S	10" Standard grip	2 lbs	49.99

### SUNCOR WINCH HANDLE HOLDER

- Quality 316 stainless steel
- Replaces bulky pockets
- Simple two fastener installation

Item	Model	Ship	Net
601374	S3520-0001	1 lbs	\$10.99

### LEWMAR WINCH HANDLE POCKET

- Fits standard winch handles
- Soft PVC, will not scratch or mar your handles
- Can be velcroed or screwed to boat (fasteners not included)

Item	Model	Ship	Net
612531	29140020	1 lbs	\$17.99

### RONSTAN QUICK-LOCK ALLOY WINCH HANDLE

- Super fast grab-and-release mechanism for single-handed removal
- Lightweight construction, corrosion resistant hard-coat, anodized finish

Item	Model	Description	Handle Length	Ship	M.A.P.
615362	RF4410	Single grip	8"	1 lbs	\$109.95
615363	RF4415	Single grip	10"	1 lbs	124.95
615364	RF4430	Palm grip	8"	1 lbs	124.95
615365	RF4435	Palm grip	10"	2 lbs	129.95



### HARKEN WINCH HANDLES

Item	Model	Description	Ship	Net
E 605830	B8AP	8" Aluminum no lock	1 lbs	\$58.99
E 605836	B10AP	10" Aluminum no lock	2 lbs	74.99
F 605831	B8AL	8" Aluminum lock-in	1 lbs	72.99
F 605837	B10AL	10" Aluminum lock-in	2 lbs	84.99
G 605832	B8ASG	8" Aluminum SpeedGrip lock-in	2 lbs	84.99
G 605838	B10ASG	10" Aluminum SpeedGrip lock-in	2 lbs	96.99
H 605834	B8CL	8" Chrome lock-in	2 lbs	97.99
H 605839	B10CL	10" Chrome lock-in	3 lbs	114.99
I 605835	B8CSG	8" Chrome SpeedGrip lock-in	3 lbs	112.99
I 605841	B10CSG	10" Chrome SpeedGrip lock-in	4 lbs	118.99
J 605840	B10ADL	10" Double grip aluminum lock-in	2 lbs	141.99

### WINCHRITE ABT CORDLESS ELECTRIC WINCH HANDLE

- Efficient lithium ion battery
- Powerful, reversible, brushless motor
- Dual rotation
- Safety chime soft start
- Universal multicharger
- Ergonomic design
- Unlike right angle drills, torque is easily controlled so as not to strip the winch sockets



### Package Includes:

- Electric winch handle, molded plastic storage cradle, 100-240 VAC shore charger, 12 VDC trickle charger, storage tote bag, stainless steel drive cog

### Specifications:

- Housing: ABS and PC plastics
- Torque: 130nm/1150in/lbs (Tested)
- Battery: 21.6 VDC Lithium-ion 2.8Ah
- Charger: 110/220 VAC and 12 VDC
- RPM: 0-130+
- Integrated rubber inlay

Item	Model	Ship	Net
606946	WR-ABT	10 lbs	\$799.00

### BLUE PERFORMANCE WINCH HANDLE POCKETS

Gray ripstop material.

Item	Model	Capacity	Dimensions	Ship	Net
608898	BP3435	(1) handle	9.4" x 3.5" x 2.8"	1 lbs	\$34.99
	BP3440	(3) handles	9.4" x 4.7" x 3.9"	1 lbs	37.99

## Snatch Blocks

**A. SCHAEFER SNATCH BLOCKS** - Ideal for genoa leads, spinnaker controls, short sheet leads

- Investment cast snap shackle with 360° rotation and 15° tilting action
- Urethane cheek covers protect the deck
- Integral bail allows the block to be "hung"

Item	Model	Description	SWL	Ship	Net
602575	05-99	For up to 5/8" line	2250 lbs	1 lbs	\$268.99
602576	07-99	For up to 3/4" line	3750 lbs	1 lbs	342.99
602640	11-99	For up to 3/4" line	5000 lbs	3 lbs	435.99

**B. RONSTAN SNATCH BLOCKS** (Snap shackle or trunnion snap shackle)

- Precision formed stainless steel frame

- Cheeks of soft resilient compound to protect your boat's finish

Item	Model	MWL	Trunnion	Sheave Dia.	Line Dia.	Ship	M.A.P.
602443	RF6710	935 lbs	No	2"	1/2"	1 lbs	\$135.95
602444	RF6711	935 lbs	Yes	2"	1/2"	1 lbs	161.95
602445	RF6720	1870 lbs	No	2-1/2"	1/2"	2 lbs	186.95
602446	RF6721	1870 lbs	Yes	2-1/2"	1/2"	2 lbs	203.95
602448	RF6741	2805 lbs	Yes	1-3/4"	5/8"	2 lbs	229.95
602449	RF6751	6610 lbs	Yes	3-1/8"	3/4"	4 lbs	489.95

### C. LEWMAR OCEAN SNATCH BLOCKS

- Sizes 1 and 2 have super tough Delrin® sheaves and large diameter stainless steel bearings
- Size 3 has an aluminum sheave and precision Stainless Steel needle roller bearings
- All Lewmar snatch blocks have removable sheaves for easy servicing

Item	Model	Size	Line	SWL	Ship	Net
606585	19810600	1	1/2"	2500 lbs	2 lbs	\$172.99
606586	19820600	2	5/8"	3500 lbs	3 lbs	199.99
606587	19830500	3	5/8"	4750 lbs	3 lbs	282.99



### D. BARTON SMALL AND MEDIUM SNATCH BLOCKS

- Extremely compact and strong with a multitude of uses on cruising and racing yachts
- Supplied with a stainless steel snap shackle

Item	Model	Description	SWL	Ship	Net
600715	90 301	For line to 1/2" diameter, SM	882 lbs	1 lbs	\$99.99
600716	90 401	For line to 5/8" diameter, MED	1212 lbs	1 lbs	135.99

### E. WICHARD SNATCH BLOCK Trunnion type snap shackle rotates 360°

- 1 piece forged head design made of 17.4 ph stainless steel—UV resistant, rubber cheeks
- Single pull pin release for arm and snap shackle

- Polycarbonate sheave rides on self-lubricating bushing over an over-sized stainless steel axle

Item	Model/Style	Sheave Dia.	Max. Rope Dia.	SWL	Ship	Net	
613557	34500	2-3/16"	1/2"	1584 lbs	1 lbs	\$167.99	
613558	35500	Becket	2-3/4"	5/8"	2640 lbs	1 lbs	222.99

### F. LEWMAR 40MM TWECKER CONTROL SNATCH BLOCK

Item	Model	Size	Line	SWL	Ship	Net
601225	29900340	2-3/16" x 3"	3/8"	309 lbs	1 lbs	\$39.99



### Wichard Gyb'Easy

Reduce the risk of injury and damage from jibing with the Gyb'Easy. The sturdy aluminum boom brake and specialized Gybe flex line use the friction of the line passing through the brake to ensure smooth safer gybes. Installation is fast and easy.

- Can be used on mainsail areas up to 430 sq. ft.
- Includes 52' of 7/16" line
- 3 different settings to better adapt to all mainsail and wind conditions
- Can be operated from the cockpit
- Only 0.6 kg and thus no extra weight on the boom



Item	Model	Ship	Net
600719	7150	5 lbs	\$241.99

### Ronstan Boom Vangs



Quality boom vang featuring Ronstan's sturdy solid bearing AP blocks and double braid polyester line spliced to the becket pins.

Item	Model	Description	SWL	Ship	M.A.P.
602529	RK6-420	20' 1/4" line, 4:1	660 lbs	1 lbs	\$104.95
602530	RK10-430NC	30' 5/16" line, 4:1	880 lbs	2 lbs	259.95
602532	RK12-435NC	35' 3/8" line, 4:1	1240 lbs	3 lbs	379.95

### Sailology TackRite Simple Boom Brake

This boom rappelling device uses different degrees of friction to slow down the boom swing when jibing. This method reduces the slamming of the boom from side to side. This is done by allowing the boom to shift while being restricted by the amount of friction rigged into the TackRite rappeller.

- Requires 1/2" line sold separately



Item	Model	Working Load	Ship	Net
608858	TR-1	8500 lbs	1 lbs	\$59.99

For more detailed product specifications and our complete selection visit [www.defender.com](http://www.defender.com) or call 800-628-8225.

### Forespar Yacht Rod

- Eliminates need for boom topping lift
- Supports boom when reefing or lowering a mainsail
- Faster and lighter than hydraulics
- Comes with Spectra line ready to add to your tackle system
- Your 4:1 equals 8:1 with the yacht rod
- Can be led to a small winch for more power
- Spring return holds boom
- Brackets for mast and boom sold separately
- Tubing is White powder coated anodized aluminum with stainless steel fittings



### YACHT ROD

Item	Model	Boat Size	Pin-to-Pin		Adj. Distance	Pin Size	Ship	Net
			Min	Max				
600374	352000	34'-40'	58-1/2"	70-1/2"	12"	1/2"	13 lbs	\$759.99
600379	352100	41'-45'	66-1/2"	80"	13-1/2"	5/8"	29 lbs	1349.99
600380	352101	46'-55'	79-1/2"	93"	13-1/2"	5/8"	32 lbs	1387.99

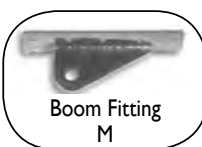

### BOOM FITTING

Item	Model	Size	Ship	Net
600375	352003	Medium	1 lbs	\$199.99
600381	352103	Large/Extra large	2 lbs	199.99

### MAST FITTING

600376	352005	Medium	2 lbs	\$249.99
600382	352104	Large/Extra large	3 lbs	359.99

### BUCCANEER DOUBLE BRAID POLYESTER SPLICED VANG LINE

- Includes (1) small spliced eye and whipped bitter end
- Applications (Not limited to these): Vangs, outhauls, downhauls, reefing line, cunninghams, gin poles

Please specify color: Black or White

Item	Strength	Length	Line Size	Ship	Net
607406	2100 lbs	20'	1/4"	1 lbs	\$22.99
607407	3000 lbs	30'	5/16"	1 lbs	31.99
607408	4200 lbs	40'	3/8"	2 lbs	37.99



### Schaefer Boom Vangs



Schaefer's vangs are among the best constructed and economical on the market today.

**4:1 Vang Tackle** - Uses Series 2 blocks (#02-43 and #25-43). Includes 20 ft. of 1/4" double braid. Stainless steel jam cleat.

**4:1 Vang Tackle** - Uses 3 Series blocks. Fast entry cam; 25' of 5/16" line.

**3:1 Vang Tackle** - Uses 5 Series blocks. Fast entry cam; 30' of 3/8" line.

**4:1 Vang Tackle** - Uses Series #5 XL blocks. Fast entry cam; 40' of 3/8" line.

**4:1 Vang Tackle** - Uses Series #7 XL snap shackle blocks. Fast entry cam; 40' of 3/8" line.

**4:1 Vang Tackle** - Uses Series #7 XL snap shackle blocks. Fast entry cam; 40' of 3/8" line.

**4:1 Vang Tackle** - Uses Series #7 XL snap shackle blocks. Fast entry cam; 40' of 3/8" line.

**4:1 Vang Tackle** - Uses Series #7 XL snap shackle blocks. Fast entry cam; 40' of 3/8" line.

### DUTCHMAN<sup>®</sup> Boom Brake

"The Best Choice,"  
Practical Sailor

The Boom Brake allows the boom to be controlled easily from the cockpit and helps prevent accidental jibes and dissipates the shock load should a jibe occur. It is beautifully crafted, cleanly designed and easy to adjust. The line that runs through the brake is secured on deck to a point at or close to the aft lower chainplates.

The BBXXX models are used with rigid vangs or soft vangs which have 2 attachment points on the boom. The BBXXXB models are for all other soft vangs and have an additional shackle at the brake bottom to which the vang attaches.



Item	Model	Boat LOA	Max. Main	SWL/Breaking Load	Ship	Net
608934	BB250	20-32'	250 sq. ft.	1600/5900	2 lbs	\$240.99
	BB250B	20-32'	250 sq. ft.	1600/5900	2 lbs	271.99
	BB500	30-45'	500 sq. ft.	2700/5900	4 lbs	375.99
	BB500B	30-45'	500 sq. ft.	2700/5900	4 lbs	424.99
	BB750	42-60'	750 sq. ft.	4100/9400	7 lbs	549.99
	BB750B	42-60'	750 sq. ft.	4100/9400	8 lbs	646.99



LIKE US ON FACEBOOK  
[FACEBOOK.COM/DEFENDERINDUSTRIES](http://FACEBOOK.COM/DEFENDERINDUSTRIES)

### BOOMKICKER

#### Boom Supports

The simple, affordable solution to eliminating the topping lift, improving sail shape and controlling the boom. Easy to install, Boomkickers mount independently above the vang. Just add on a Boomkicker and remove the topping lift. Fittings are included with the boom track fitting. Models K0312 and K0400 for daysailers use a sling at the boom for even easier rigging. When you compare performance, quality, price, ease of installation and rigging, you'll find Boomkicker on top.



Item	Model	Boat Size	Initial Length	Max Force	Ship	M.A.P.
608935	K0312	14'-16'	30"	75 lbs	2 lbs	79.05
	K0400	16'-19'	34"	150 lbs	3 lbs	133.45
	K0500	16'-20'	36"	150 lbs	4 lbs	184.45
	K0750	20'-25'	36"	250 lbs	4 lbs	187.00
	K0800	25'-27'	45"	300 lbs	5 lbs	232.05
	K1000	27'-30'	45"	400 lbs	6 lbs	235.45
	K1250	30'-34'	53"	500 lbs	8 lbs	285.60
	K1500	34'-38'	53"	600 lbs	8 lbs	291.55

Most orders placed by 4:30pm Eastern time (Monday - Friday) ship the same day!

800-628-8225  
[www.defender.com](http://www.defender.com)

## Furling Systems & Furling Accessories

### WICHARD STANCHION FAIRLEAD

- Designed to be installed on 25 mm (1") stanchions
- Perfect solution to deviate furling line of manual furlers or flying sail furlers with drum
- Material: Grade stainless steel

Item	Model	Ship	Net
608822	20120	1 lbs	\$20.99

### WICHARD DOUBLE STANCHION FAIRLEAD FOR CONTINUOUS LINE

- Material: Stainless steel
- Includes Velcro® strip
- Designed to be installed on 25 mm stanchions

608823	20220	1 lbs	\$61.99
--------	-------	-------	---------

### WICHARD ARTICULATED STANCHION FAIRLEAD

- Type: Articulated single
- Material: Stainless steel
- Designed to be installed on 25 mm (1") and 28 mm stanchions

608824	21120	1 lbs	\$28.99
--------	-------	-------	---------



### ALLEN STANCHION MOUNTED FAIRLEAD

- Stanchion diameter: 25 mm (1") • Length: 60 mm (2-3/8")
- Line diameter: 8-10 mm (5/16"- 3/8"), 14 mm (9/16") max
- Includes stainless steel bushing

Item	Model	Ship	Net
605740	A.455	1 lbs	\$17.99

### ALLEN A450A STANCHION MOUNTED BLOCK

- With removable pin
- Line size: 8-10 mm (5/16"- 3/8"), 14 mm (9/16") maximum

Item	Model	Ship	Net
605738	A.450A	1 lbs	\$37.99

- ### SPINLOCK FURLING LINE LEADS - All ship 1 lbs
- Low profile design cuts furling line friction. Fairlead model WL/1 bullseye lead. Sheave model WL/2 for line entry and exit. Unique tracker ball angle adjuster for perfect sheave alignment. Comes complete with fastenings. Line dia.: 3/32"-1/2" Max SWL: 660 lbs, Stanchion: 1"

Item	Model	Net
608666	WL/1 Stanchion lead bullseye	\$15.99
608669	WL/2 Stanchion lead block	32.99



### SCHAEFER STANCHION/RAIL MOUNT FURLING BLOCK

- Great for leading your furling line aft along stanchion bases to cockpit
- Contoured base, stainless steel brackets for easy, secure installation
- Stainless steel/Delrin cheek sheave, 1/2" max line

**Clamp-on furling lead block.** Delrin™ ball bearing sheave allows for quick and easy furling line adjustment. Stainless steel cage and strap ensure durability. First stanchions 1" in diameter. 1-7/16" sheave diameter; Maximum 1/2" line size. Safe working load = 1000 lbs

Item	Model	Ship	Net
602721	300-34	1 lbs	\$48.99

**Clamp-on pulpit block.** Spring mounted block articulates to adjust for the final lead into furling systems.

602722	300-35	1 lbs	\$86.99
602919	500-35	1 lbs	130.99

### SCHAEFER LEAD BLOCK KITS

Clamp-on block kit includes (1) 300-35 and (3) 300-34 blocks.  
602727 300-75 Weighs 1 lbs 6 oz. Ship 1 lbs Net \$244.99

### SCHAEFER "CLEAR STEP" FURLING LEAD BLOCK KIT

- Stanchion diameter: 1"
- Maximum line size: 1/2"
- Safe working load: 1000 lbs (clamp on pulpit) / 750 lbs (clear step block)
- Includes: (1) pulpit furling block and (3) stanchion blocks

602728	300-76	Ship 2 lbs	Net \$238.99
--------	--------	------------	--------------

### SCHAEFER "CLEAR STEP" OUTSIDE LEAD BLOCK

- Lead furling line outside the stanchions to clear walkways
- Sheave accommodates up to 1/2" line and runs on low friction ball bearings
- Block slips easily over 1" stanchions and is secured by a set screw
- Cheek sheave is Stainless/Delrin; sheave dia. 2-3/8"; length 3-1/8"

Item 602995 506-44 weighs 5 oz. Ship 1 lbs Net \$47.99  
With Stainless/aluminum cheek sheave; SWL 850 lbs., 5/8" max line dia.; length 2-7/8"; width 3-5/8"; weight 7 oz. Fits 1-1/4" stanchions.  
Item 603199 706-44 Ship 1 lbs Net \$104.99



### SELDÉN DOUBLE LINE STANCHION FAIRLEAD

- Designed specifically for use with continuous furling lines
- Double fairlead consists of a composite bracket with a stainless steel twisting retainer

• Stanchion diameter: 25 or 30 mm  
• Dimensions: 58 mm W x 72 mm H  
Item 608788 Model 480-501-01 Ship 1 lbs Net \$74.99



### HARKEN CARBO FURLING LEAD BLOCKS

Lightweight, UV stabilized and run on ball bearings for easy adjustment under any load. Blocks mount with a strong four screw clamp eliminating the need to remove the lifelines or stanchions. Use the 7401 as the forward inboard lead, the 7402 for outside leads and the 7403 as the aft inboard lead.

Item	Model	Sheave	Max Line	Max SWL	Use with	Net
615523	7401	1-9/16"	3/8"	485 lbs	1" stanchions	\$43.99

**Harken 57 mm Carbo Ratchet Lead Block-** Ships 1 lbs  
601159 7402 2-1/4" 3/8" 500 lbs 1" stanchions \$81.99

**Harken 29 mm Carbo Outboard Lead Block Assembly-** Ships 1 lbs  
600882 7403 1-1/8" 3/8" N/A 1" stanchions \$41.99

**Harken Furling Lead Block Kit-** Ships 2 lbs  
Item Model Kit includes Net  
600110 7404 (3) 7403 - 29 mm outboard stanchion lead block assembly \$266.99  
(1) 7402 - 57 mm Carbo ratchet block stanchion lead block assembly,  
(1) 7401 - 40 mm Carbo block stanchion leadblock assembly, (1) cleat

### HARKEN JIB HALYARD RESTRAINERS

Harken jib halyard restrainers have stainless steel brackets and feature Hardkote-anodized aluminum sheaves that accommodate both wire and rope.

Item	Model	Use with	Units	Fasteners	Ship	Net
605997	944	00AL/0/1		#10 RH	1 lbs	\$63.99
612388	945	2, 2.5, 3, 3.5		#10 RH	1 lbs	82.99



### MARLOW FURLING LINE

- Easy splicing for endless loops
- Applications: Furling systems and replacement furling lines
- Light Gray/Dark Gray
- Material: Vectran® / polyester blend; polypropylene core
- Construction: 16 plait
- Core can be removed and yet retain strength due to construction

Item	Model	Line Diameter	Ship/ft.	Net/ft.
608856	FUU032	8 mm	1 lbs	\$1.59
	FUU033	10 mm	1 lbs	2.69



### HARKEN MKIV

Free-rolling systems allow racers and cruisers to quickly furl and reef while maintaining great sail shape and optimal speed.

- Strong, easy to assemble foils
- Removable split drum fits over existing turnbuckle
- Aerodynamic double groove foils for racing

#### UNIT 0 • FOR BOATS 22'-30'

Item	Model	Wire Size	Ship	Net
600092	7410.10	5/32", 3/16", 7/32"	22 lbs	\$1844.99

#### Toggle Assemblies

600093	7410.20	3/8" with 3/8" clevis pin	1 lbs	\$61.99
600094	7410.20	7/16" with 7/16" clevis pin	1 lbs	61.99

#### UNIT 1 • FOR BOATS 28'-36'

600095	7411.10	1/4", 9/32", 5/16"	31 lbs	\$2666.99
--------	---------	--------------------	--------	-----------

#### Toggle Assembly

600096	7411.20	1/2" with 1/2" clevis pin	1 lbs	\$70.99
--------	---------	---------------------------	-------	---------

#### UNIT 2 • FOR BOATS 35'-46'

600097	7412.10	5/16", 3/8"	90 lbs	\$4018.99
--------	---------	-------------	--------	-----------

#### Toggle Assembly

600098	7412.20	5/8" with 5/8" clevis pin	3 lbs	\$91.99
600109	7312.20	3/4" with 3/4" clevis pin	6 lbs	570.99



ESP Leg Kit is required for installation of all ESP Jib Reefing and Furling Systems

### HARKEN ESP JIB REEFING & FURLING SYSTEMS

Designed for the coastal cruiser or daysailer looking for an easy-to-assemble, efficient and reliable furler. Furl/reef safely from the cockpit when it blows; unfurl when it gets light for a great day of sailing!

#### UNIT 0 • FOR BOATS 20'-28'

Item	Model	Wire Size	Clevis Pin	Ship	Net
606331	7320.10	5/32", 3/16"	5/16", 3/8"	18 lbs	\$1122.99

#### UNIT 1 • FOR BOATS 26'-35'

606328	7321.10	1/4, 5/16", 7/32", 9/32"	7/16", 1/2"	35 lbs	\$1668.99
--------	---------	--------------------------	-------------	--------	-----------

#### UNIT 2 • FOR BOATS 34'-46'

606334	7322.10	5/16", 3/8", 7/16" 5/8", 3/4"		40 lbs	\$2546.99
--------	---------	-------------------------------	--	--------	-----------

#### UNIT 3 • FOR BOATS 45'-61'

606337	7323.10	1/2", 9/16", 5/8", 7/8", 1"		90 lbs	\$4023.99
--------	---------	-----------------------------	--	--------	-----------

#### HARKEN ESP LEG KITS

- Long leg kits for furlers with turnbuckles

#### Specify clevis pin diameter.

Item	Unit	Clevis Diameter	Ship	Net
606332	0	3/8" or 5/16"	4 lbs	\$219.99
606329	1	7/16" or 1/2"	4 lbs	245.99
606335	2	5/8" or 3/4"	4 lbs	349.99
606338	3	7/8" or 1"	8 lbs	457.99







**Furling/Reefing Systems**

Schaefer's improvements surpass their already outstanding reputation for corrosion resistance, ease of installation and reliability. Each system is assembled over the existing headstay and turnbuckle; low friction inserts help prevent chafe and noise. Torlon® ball bearings ensure easy reefing/furling. 5-year manufacturer's warranty. Ships direct from manufacturer.



Item	Model	For Boats	Standard System L	Wire and Pin Diameters	Ship	Net
602618	1100-01	27'-31'	43'	3/16"+3/8"	59 lbs	\$2227.99
602619	1100-02			7/32"+7/16"	59 lbs	2281.99
602620	1100-03			1/4"+1/2"	59 lbs	2299.00
602672	2100-01	30'-42'	49'3"	1/4"+1/2"	68 lbs	3128.99
602673	2100-02			9/32"+1/2"	68 lbs	3149.99
602674	2100-03			5/16"+5/8"	68 lbs	3170.99
602752	3100-01	41'-55'	64' 7-1/2"	5/16"+5/8"	110 lbs	4315.99
602753	3100-02			3/8"+5/8"	110 lbs	4357.99
602754	3100-03			7/16"+3/4"	110 lbs	4542.99

**Schaefer SnapFurl CF-500**

Intended for daysailers and small cruising boats to 24', the Snapfurl offers many of the features employed in Schaefer's larger headsail furling systems including open Torlon ball bearing races. The foil is a two-piece, interlocking, round PVC extrusion. The single piece torque tube and drum are made of high strength, long-grain nylon composite with UV inhibitors.

- Furling and reefing capabilities
- Stainless Steel open drum cage for protection and easy access to furling line

CF-500 uses wire size 1/8 (3 mm), 5/32 (4 mm) or 3/16 (5 mm). Furling line size is 1/4 (7 mm).

Item	Model	System	Luff Length	Weight	Pin Size	Extrusion	Ship	Net	
D 603538	CF-500	31'1"	#5	15.7 lbs.	up to 3/8"	.3 lbs. Ft.	38 lbs	\$757.99	
<b>OPTIONAL FAIRLEAD ARM</b>									
603544	CF-500-22	Fairlead arm for CF-500 SnapFurl						1 lbs	\$52.99



**Schaefer SnapFurl CF-700**

The SnapFurl CF-700 is machined of high quality aluminum and reliable Geon PVC extrusions that snap together and interlock. This system can be easily installed by the owner in under an hour. The product is designed to work with the existing headstay eliminating the need for shortening the headstay. The torque tube and drum housing is machined 6061-T6 aluminum. The drum case is Stainless Steel. The system is designed for sailboats up to 28'.

Item	Model	System Length	Headstay Dia.	Sail Luff Tape	Line Size	Ship	Net
D 614856	CF-700	38'	5/32-7/32"	#6 or 3/16"	5/16"	90 lbs	\$1184.99

Ⓢ Ships Ground Only - No Extra Charge  
 Ⓢ Larger Size Product, Ships at Dimensional Weight  
 🚚 Ships by Truck  
 ⚠ Hazardous Material. \$35.00 Fee and Ships Ground Only



**Profurl Headsail Management Equipment**

- Long link plates are standard
- New double cage design
- Other pin sizes available by Special Order



Item	Boat Size	Max Forestay	Max. Sail Area	Profurl Model	Standard Pin Size	Standard Luff Length	Ship	Net
<b>CLASSIC CRUISING</b>								
612496	24-34'	9/32" dia.	410 sq. ft.	NC-32D	3/8"	40'	31	\$2079.99
612498	24-34'	9/32" dia.	410 sq. ft.	NCI-32D	3/8"	40'	32	2153.99
612503	34-39'	5/16" dia.	480 sq. ft.	LCI-32D	1/2"	46'	35	2461.99
612508	39-47'	3/8" dia.	640 sq. ft.	NC-42D	5/8"	52'	51	3076.99
612511	39-47'	3/8" dia.	640 sq. ft.	NCI-42D	5/8"	52'	63	3333.99
612515	47-54'	1/2" dia.	850 sq. ft.	LC-42D	5/8"*	60'	69	3897.99
612516	47-54'	1/2" dia.	850 sq. ft.	LCI-42D	5/8"*	60'	70	4100.99

**NEW LINE CRUISING**

615115	20-34'	1/4" dia.	350 sq. ft.	C290	3/8"	40'	29	\$1224.99
615116	34-39'	9/32" dia.	400 sq. ft.	C320	1/2"	46'	36	1659.99
615117	39-43'	5/16" dia.	450 sq. ft.	C350	1/2"	52'	49	2130.99
615118	43-47'	3/8" dia.	620 sq. ft.	C420	5/8"	60'	67	2809.99
615119	47-55'	1/2" dia.	800 sq. ft.	C430	3/4"	60'	69	3197.99

\* Standard pin size is 5/8". Other sizes available. Please call Defender at 800-628-8225 to arrange/order pin swap.

Extra extrusions available by Special Order. Please contact us for pricing and availability.

**Spinex Spinnaker Furler**

- Exclusive Sail Bearing™ technology eliminates binding and reverse furling
- Large drive diameter drum
- One-button luff line attachment
- Features continuous line drive unit
- For use with asymmetrical spinnakers
- Lower terminal: Clevis snap shackle
- Upper terminal: HR D shackle
- 3 year warranty

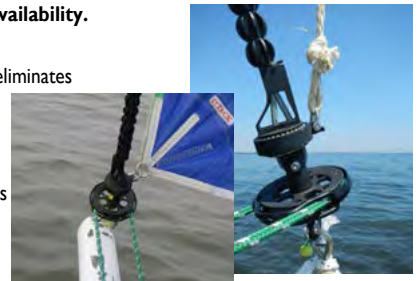

Model Name	SPINEX 0.9	SPINEX 1.5	SPINEX 2.5	SPINEX 5.0
Item	D 604461	D 604462	D 604463	D 604464
Model number	SPINEX 0.9	SPINEX 1.5	SPINEX 2.5	SPINEX 5.0
Boat length max	29'	35'	44'	60'
Working load	0.9 T	1.5T	2.5T	5.0T
Anti twist torque rope	3/8" - included	3/8" - included	1/2" - included	5/8" - included
Continuous line	5/16" x 24'L	3/8" x 31'L	3/8" x 33'L	3/8" x 46'L
Weight / spool	1.5 lbs	2 lbs	3.5 lbs	4 lbs
Weight / swivel	.5 lbs	1lbs	1.5 lbs	2 lbs
Cable weight	9 lbs	10 lbs	17 lbs	22 lbs
Shipping weight	39 lbs	42 lbs	42 lbs	47 lbs
Price	Net \$1690.99	Net \$1978.99	Net \$2510.99	Net \$3893.99



Furlex is sold as a complete kit which means no need for sourcing a forestay from a rigging shop. Full kit including forestay wire, foils, drum and swivels, furling line, stanchion blocks, tools and grease to build and service the system.



Facnor furlers are well known for their reliability and their simplicity of installation by the well known boat builders. Each furler is composed of a drum, a series of sections which come around the forestay and a hoisting system: halyard swivel or sheave box.



See our complete line of furlers including the following series:  
 Sea flex • SL series • Seafurl 5  
 Available at [www.Defender.com](http://www.Defender.com)

**SCHAEFER T-TRACK**

Made of anodized aluminum, this track features three stop pin holes between fastener holes. Holes at 1-3/8" (34 mm) intervals allow sailors to fine tune sails with three times the adjustment of normal track. The T-track also works well with reefing blocks and spinnaker mast eyes. The concave shaped riser fits most spar sections and allows for proper sealant bedding on flat surfaces. Fastener spacing at 4".

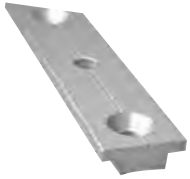

1" x 1/8" Black Anodized			1" x 1/8" Clear Anodized (Silver)		
Item	Model	Length	Ship	Net	
608932	40-62	2'	1 lbs	\$46.99	
	40-64	4'	2 lbs	79.99	
	40-66	6'	2 lbs	102.99	
D	40-68	8'	3 lbs	137.99	
1-1/4" x 3/16" Black Anodized			1-1/4" x 3/16" Clear Anodized (Silver)		
Item	Model	Length	Ship	Net	
608933	40-72	2'	1 lbs	\$50.99	
	40-74	4'	2 lbs	87.99	
	40-76	6'	3 lbs	127.99	
D	40-78	8'	4 lbs	163.99	
D	40-80	10'	5 lbs	198.99	

**SCHAEFER T-TRACK END STOPS**

Withstands impact without damage. For use with aluminum or stainless steel track.



Item	Model	Track Size	Color	Ship	Net ea.
603239	74-34	3/4" x 1/8"	Black	1 lbs	\$7.99
603241	74-35-G	1" x 1/8"	Gray	1 lbs	7.99
603240	74-35	1" x 1/8"	Black	1 lbs	7.99
603243	74-36-G	1-1/4" x 3/16"	Gray	1 lbs	7.99
603242	74-36	1-1/4" x 3/16"	Black	1 lbs	7.99

**SCHAEFER "TWIN SHEET" GENOA LEAD BLOCKS**

Schaefer lead blocks are designed with extra wide diameter sheaves to accommodate two sheets. Sheaves are machined from aluminum bar and turn on Nomex™/Teflon® N.T.E. bearings.



Item	Model	SWL	Track Size	Color	Ship	Net
602772	32-77	2500 lbs	1"	Black	1 lbs	\$179.99
602774	32-88	2500 lbs	1"	Silver	1 lbs	179.99
602776	32-97	3500 lbs	1-1/4"	Black	2 lbs	223.99
602777	32-98	3500 lbs	1-1/4"	Silver	2 lbs	223.99
602771	32-58	4400 lbs	1-1/4"	Silver	3 lbs	360.99



**SCHAEFER HALF-MOON LEAD BLOCK ON T-TRACK SLIDER**

Rugged offshore design provides a low winch lead while spreading sheet loads over several track fasteners.

- Centered pin prevents snags and accidental release
- Articulates up to 45°
- Aluminum sheave
- Bolted stainless steel construction allows disassembly for inspection and maintenance



Item	Model	SWL	Track Size	Ship	Net
602769	32-33-UC	5000 lbs	1-1/4" x 3/16"	2 lbs	\$555.99

**SCHAEFER STAND-UP SPRING GENOA LEAD BLOCK**

- Stainless steel stand-up spring block on T-track slider
- Spring supports block
- Spring pin locks slide in place
- Polyethylene liners reduce friction on slide
- All ship 1 lbs



Item	Model	SWL lbs	Track Size	Line	Sheave	Net
For boats to 27'						
602978	505-82	1750	1" x 1/8"	7/16"	2"	\$120.99
For boats to 33'						
603184	705-92	2250	1-1/4" x 3/16"	1/2"	2-3/8"	165.99

**SCHAEFER ALUMINUM STAND-UP SPRING BLOCK**

- Spring loaded genoa block on 1" T-track slider
- For boats up to 27'; max sail area 315 sq. ft.
- Polyethylene liners reduce friction on slide
- Spring pin locks slide in place
- Ship 1 lbs



Item	Model	SWL lbs	Track Size	Line	Sheave	Net
602954	504-82	1750	1" x 1/8"	7/16"	2"	\$102.99

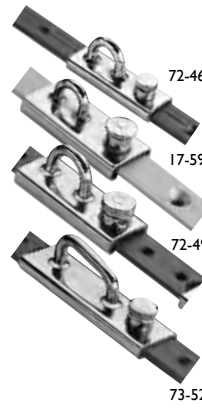

**SCHAEFER STAINLESS T-TRACK SLIDERS**

Schaefer sliders provide strong and easily adjustable attachment points for a variety of applications. Polyethylene liners reduce friction.

Item	Model	Track Size	LOA	SWL	Ship	Net
603213	72-46*	3/4" x 1/8"	20'	750	1 lbs	\$71.99
602656	17-59	1" x 1/8"	27'	750	1 lbs	72.99
603214	72-49	1-1/4" x 3/16"	38'	2500	1 lbs	90.99
603229	73-52*	1-1/2" x 1/4"	48'	5000	1 lbs	172.99

\*72-46 and 73-52 do not have liners.

**SCHAEFER SPINNAKER SLIDERS**

Choose from super strong investment cast sliders or welded sliders with friction reducing polyethylene liners. All towable versions are welded and have liners.



Item	Model	Description	Track size	Ring I.D.	Ship	Net
603226	73-38	Welded/lined	1" x 1/8"	1-1/4"	1 lbs	\$89.99
603222	73-32	Cast	1" x 1/8"	1-3/16"	1 lbs	94.99
602659	17-78	Towable/lined	1" x 1/8"	1-1/2"	1 lbs	81.99
602661	17-87	Welded/lined	1-1/4" x 3/16"	2"	1 lbs	123.99
603223	73-33	Cast	1-1/4" x 3/16"	2"	2 lbs	123.99
602660	17-84	Towable/lined	1-1/4" x 3/16"	2"	1 lbs	110.99

**SCHAEFER TOWABLE TWIN SHEET LEAD KIT SYSTEM**

Wide sheave for dual-sheet application; Stainless steel slide with low friction polyethylene liners; high load Nomex Teflon sheave bearing; lightweight aluminum sheave and cage housing. Quick and easy adjustment for proper sail trim allows cockpit adjustment for (reefing) lead changes. Port and starboard included in kits.

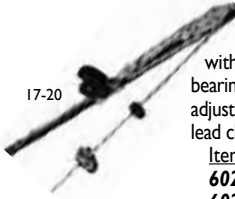

Item	Model	SWL	Track	Ship	Net
602652	17-20	2500 lbs	1" x 1/8"	7 lbs	\$1102.99
602657	17-60	3500 lbs	1-1/4" x 3/16"	12 lbs	1711.99



**LEWMAR®**

Kits available for boats up to 48'

**Lewmar Genoa Lead Systems**

- Popular for cruising and racing yachts
- Large sheaves for efficient line handling
- All kits include end stops
- Port and starboard

**SIZE 0 OCEAN SERIES for boats to approximately 28'**

Item	Model	Kit includes	Ship	Net
607348	20000716	Plunger style car (2) and 1.5 m track (2)	7 lbs	\$442.99

**SIZE 1 NTR SERIES for boats to approximately 36'**

Item	Model	Kit includes	Ship	Net
607349	20000717	Plunger style car (2) and 1.5 m track (2)	12 lbs	\$421.99

**SIZE 2 NTR SERIES for boats to approximately 48'**

Item	Model	Kit includes	Ship	Net
D607350	20000718	Plunger style car (2) and 2.0 m track (2)	44 lbs	\$631.99

**SIZE 1 NTR LINE CONTROL Series for boats to approximately 36' (not shown)**

Item	Model	Kit includes	Ship	Net
607351	20000719	Torlon ball single sheave genoa cars (port and starboard); end stop with single sheave and shackle(2) and 1.5 m track (2)	12 lbs	\$566.99

**SIZE 2 NTR LINE CONTROL Series for boats to approx. 48'**

Item	Model	Kit includes	Ship	Net
D607352	20000720	Torlon ball single sheave genoa cars (port and starboard); end stop with single sheave and shackle (2) and 2 m track(2)	34 lbs	\$824.99



**Ronstan Jib Lead System**

**RONSTAN SERIES 25 T-TRACK TRAVELER RACING SYSTEM KIT**

Low profile and lightweight with removable attachment pin suits either Dyneema® Link or a shackle. Integrated becket for 2:1 headsail sheet systems • (2) 465 mm (1' 6") racing tracks • (10) Track bolt insulators • (2) Composite slides with Series 55 BB orbit blocks™ • (4) Track ends

Item	Model	SWL	Track	Ship	M.A.P.
615292	RC72540S	1100	1'6"	2 lbs	\$224.95
615284	RC72537S		Lead Car Only	1 lbs	85.95



# LEWMAR® Mainsheet Traveler Kits

Traveler kits are made of all necessary components to assemble a standard system. Each one comes with Lewmar's sliding bolt track allowing you to retrofit the new track to your deck using the original bolt holes.

## SIZE 0 MAINSHEET SYSTEM - For boats up to 28' end boom

Kit includes: (1) Mainsheet car shackle, (2) End stops, (1) 1.2 meter sliding bolt track, (1) Size 1 Dead eye, (2) Small composite cleats, (2) Small cam fairleads, 1/4" control line (not included)

Item	Model	End Boom	Mid Boom	SWL	Ship	Net
607643	29060152BK	170 ft <sup>2</sup>		990 lbs	3 lbs	\$229.99

## SIZE 1 MAINSHEET SYSTEM - For boats up to 36' end boom

Kit includes: (1) Mainsheet car shackle, (2) Double control line sheaves, cleats and becket, (2) End stops with double control line sheaves, (1) 1.5 meter sliding bolt track, 5/16" control line (not included)

Item	Model	End Boom	Mid Boom	SWL	Ship	Net
607353	29461354BK	366 ft <sup>2</sup>	226 ft <sup>2</sup>	1980 lbs	9 lbs	\$449.99

## SIZE 2 MAINSHEET SYSTEM - For boats up to 48' end boom

Kit includes: (1) Mainsheet car shackle, (2) Double control line sheaves, cleats and becket, (2) End stops with double control line sheaves, (1) 1.8 meter sliding bolt track, 3/8" control line (not included)

Item	Model	End Boom	Mid Boom	SWL	Ship	Net
601648	29462354BK	495 ft <sup>2</sup>	410 ft <sup>2</sup>	2000 lbs	9 lbs	\$599.99

## BUCCANEER DOUBLE BRAID TRAVELER LINE KIT - Gray with Yellow tracer, sold as a pair

Includes (2) lines. Each line has a 1" eye splice for easy, clean attachment.

Item	Model	Line Size	Tensile Strength	Ship	Net
607404	403-08-99-30	1/4" x 30'	2100 lbs	2 lbs	\$42.99
607405	403-10-99-35	5/16" x 35'	3000 lbs	3 lbs	\$4.99

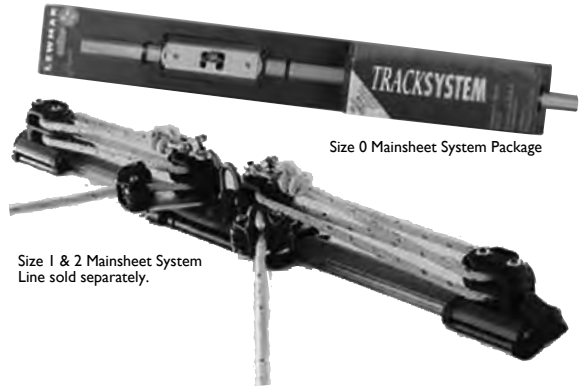

Size 0 Mainsheet System Package

Size 1 & 2 Mainsheet System Line sold separately.



# SCHAEFER LEGENDARY STRENGTH

## Traveler Systems

### SCHAEFER MARINE TRAVELERS

- Captive stainless steel ball bearings ensure smooth operation
- Hardcoat anodized track with Teflon® impregnation
- Track is extruded from marine grade, thick-walled aluminum
- Aluminum, hardcoat anodized control blocks
- Stainless steel cheeks
- Use stand up adapters to match traveler car with blocks
- Bridge systems use Schaefer pass-through-pod or hinged pod

### TRAVELER SYSTEM 42-00 BRIDGE SYSTEM- FOR BOATS 30-42 FT

Complete bridge traveler system: includes 5' piece of 1-1/2" bridge track, (2) end stops, six-wheel ball bearing car, dual sheave control blocks, (2) hinged pods and (2) 506-60 lead blocks.

Item	Model	Ship	Net
602871	42-00	41 lbs	\$2121.99

### TRAVELER SYSTEM FOR BOATS- FOR BOATS 29-37 FT

A complete system: includes 5' piece of 1-1/2" track, (2) end stops, six-wheel ball bearing car, dual sheave control blocks and 7 series stand-up adapter.

Item	Model	Ship	Net
614712	SK-7367	24 lbs	\$659.99

### TRAVELER SYSTEM FOR BOATS- FOR BOATS 22-28 FT

A complete system includes 4' length of 1-1/8" track, (2) end stops, four-wheel ball bearing traveler car, dual sheave control blocks and 5 series stand-up adapter.

Item	Model	Ship	Net
614713	SK-7366	9 lbs	\$473.99

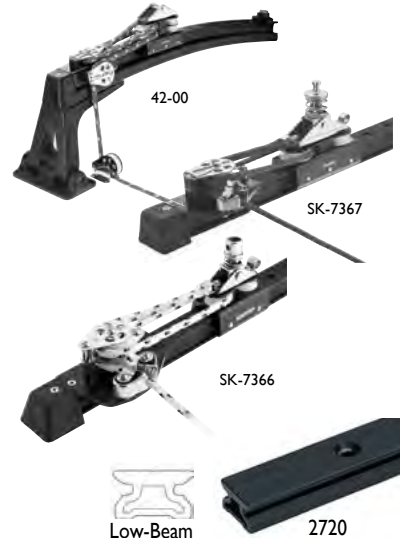

42-00

SK-7367

SK-7366

Low-Beam

2720

# HARKEN

## Traveler Kits, Tracks & End Stops

**Low-Beam** - A lightweight track, ideal for installations where the track is supported for its entire length.

**Hi-Beam** - Designed to bridge cockpits and companionways or other unsupported areas. Fasteners are hidden.

### TRACKS- LOW-BEAM

Item	Model	Ship	Net
608940	2720.1M	1 lbs	\$54.99
	2720.1.2M	2 lbs	67.99
	2720.1.5M	2 lbs	79.99

Common specifications: Hole spacing - 3.94" Fasteners - #10 FH for 2720 Fasteners - 5 mm hex-head for 2721 (fasteners not included.)

### TRACKS- LOW-BEAM With pinstop holes

Item	Model	Ship	Net
608941	R27.1M	2 lbs	\$70.999
	R27.1.5M	3 lbs	103.99
	R27.2M	2 lbs	137.99
D	R27.2.5M	90 lbs	167.99

### TRACKS- HI-BEAM

Item	Model	Ship	Net
608942	R27HB.1M	4 lbs	\$127.99
	R27HB.1.5M	6 lbs	168.99
	R27HB.1.8M	7 lbs	190.99
D	R27HB.2.5M	90 lbs	257.99

### END STOP/TRIM CAPS-LOW BEAM

Item	Model	Description	Net
602168	E2700	End stop (pr.)	\$12.99
615544	1621	Trim cap (pr.)	13.99

All ship 1 lbs.

### END STOP/TRIM CAPS-HI BEAM

Item	Model	Description	Net
605036	1523	End stop (pr.)	\$48.99
601162	1622	Trim cap (pr.)	18.99

All ship 1 lbs.

Item	Model	Purchase	Max. Line	Includes	Track Size	Ship	Net
608832	2763	2:1	1/4"	22 mm Traveler car with fixed sheaves and eyestraps, (2) End controls	22 mm	8 lbs	\$517.99
608833	2764	3:1	1/4"	22 mm Traveler car with toggle, 29 mm block, (2) End controls	22 mm	5 lbs	606.99
608834	1654	3:1	5/16"	27 mm Traveler car with shackle and (2) End controls	R27 or R27HB	4 lbs	587.99
608835	1655	4:1	5/16"	27 mm Traveler car with shackle and (2) End controls	R27 or R27HB	4 lbs	615.99
608836	3190	4:1	3/8"	32 mm Traveler car and (2) End controls	R32 or R32HB	5 lbs	774.99

### HARKEN REPLACEMENT TRAVELER KITS

- Harken replacement traveler kits are the fastest, easiest way to replace an old traveler with one that fits and works correctly
- Take the guesswork out of picking the right parts
- Kits include car and end controls
- Note: Purchase track and fasteners separately

See [defender.com](http://defender.com) for track selections

## Non-Captive Bearing Traveler Car Rebuild Kits & Replacement Ball Bearings

### REBUILD KITS

Item	Model	Size	Ship	Net
603530	HSB501	7/8", Small boat	1 lbs	\$41.99
603531	HMR99	1-1/16", Midrange	1 lbs	52.99
603532	HBB197	1-1/4", Big boat	1 lbs	63.99

### REPLACEMENT BEARINGS

Item	Model	Size	Balls*/Per bag	Ship	Net
601800	177	Small boat	1/4" / 21	1 lbs	\$12.99
605039	1526	Midrange	5/16" / 25	1 lbs	20.99
605181	547	Big boat	3/8" / 25	1 lbs	24.99

### NON-CAPTIVE BEARING TRAVELER CAR REBUILD KITS

Use for older non-CB ball bearing cars. Kit contains new end caps, screws, Teflon ball bearings, ball loader, Blue Loctite® and instructions.



HSB501, HMR99, HBB197

**DEFENDER** maintains inventory of sailcloth in a variety of weights and colors. All are appropriate for a multitude of do-it-yourself projects. Additional sailcloth available by special order.

**NYLON RIPSTOP SAILCLOTH:** Used for spinnakers, staysails, drifters, kites.

Item	Description	Specify Color	Ship/ft	Net/yd.
612640	60" wide, 1.5 oz.	Blue, Red or White	1 lbs	\$11.99

**DACRON SAILCLOTH:** Used for mainsails and headsails, bags and curtains.

Item	Description	Color	Ship/ft	Net/sq. yd.
612631	36" wide, 4 oz./sq. yd.	White	1 lbs	\$14.99
612642	54" wide, 6.5 oz./sq. yd.	White	1 lbs	26.99
612634	54" wide, 9 oz./sq. yd.	White	1 lbs	29.99

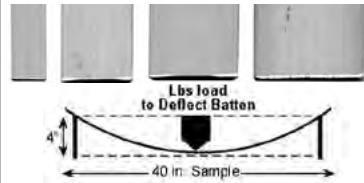
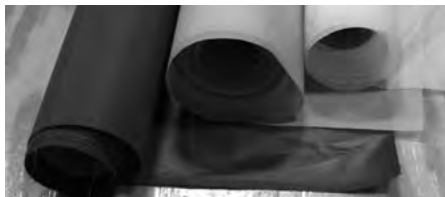

Item	Length	Width	Ship	Net
613604	3'	5/8"	1 lbs	\$4.19
613605	5'	5/8"	1 lbs	5.69
613606	7'	5/8"	1 lbs	6.99
613607	12'	5/8"	1 lbs	10.98
Item	Length	Width	Ship	Net
613612	3'	1-5/8"	1 lbs	\$11.99
613613	5'	1-5/8"	1 lbs	17.99
613614	7'	1-5/8"	2 lbs	23.99
613615	12'	1-5/8"	3 lbs	38.99

**BETE-FLEMING SAIL BATTENS**

White fiberglass. Available in 3', 5', 7' and 12' lengths. Batten stiffness ratings represent the number of pounds required to deflect 40" length of batten 4" from its original unflexed state. See the "Batten Stiffness Ratings" table below. Lengths over 12' available by Special Order.

Item	Length	Width	Ship	Net
613608	3'	1-5/16"	1 lbs	\$7.49
613609	5'	1-5/16"	1 lbs	12.99
613610	7'	1-5/16"	1 lbs	17.49
613611	12'	1-5/16"	2 lbs	26.99
Item	Length	Width	Ship	Net
613616	3'	2"	1 lbs	\$17.99
613617	5'	2"	2 lbs	28.99
613618	7'	2"	3 lbs	35.99
613619	12'	2"	4 lbs	57.99

BATTEN STIFFNESS RATINGS	
Batten Width	Lbs of Pressure
1"	3
1-5/16"	6
1-5/8"	8

**BATTEN END CAPS** All ship 1 lbs.

Item	Model	Cap Size	Net
613559	15 CTWT	5/8"	\$1.49
613560	35 CTEC	1-5/16"	1.59
613561	40 CTEC	1-5/8"	1.69
613562	50 CTEC	2"	1.79

Additional sail battens available at [www.defender.com](http://www.defender.com).



**ATN GENOA SLEEVE**

Protects the furled sail without the sacrificial sun cover.

- Does not alter or weigh down the sail
- No need to lower the sail to install the Sun Shield
- The Genoa Sleeve is hoisted with the spinnaker halyard
- Keeps the sail tight even in a strong breeze
- Won't flog to self destruction
- Custom manufactured to length and sold by the foot

Available in 13 Colors - visit [www.Defender.com](http://www.Defender.com) for selection

Item	Description	Ship/Ft.	Net/Ft.
608881*	Up to 60 ft	1 lbs	\$12.99
608882*	51 - 75 ft	1 lbs	16.99
608883*	76 - 100 ft	1 lbs	20.99
608884*	Over 100 ft	2 lbs	27.99

\*Note: Custom cut and has an approximately 7 day lead time to build. Ships direct from manufacturer.



**ATN SPINNAKER SLEEVE**

- Singlehand any spinnaker, reacher, gennaker, MPS, screecher or mizzen staysail up to 15,000 sq. ft.
- High-tech canvas hoop matches shape of the spinnaker and will not warp under load
- Single control line through separate sleeve eliminates fouling
- Mesh construction allows sails to dry quicker while stored
- Cut to length and sold by the foot

Item	Size	Ships	Net/Ft.
612378*	Up to 55'	15 lbs per 50 feet	\$12.99

\*Note: Custom cut and has an approximately 7 day lead time to build. Ships direct from manufacturer. Larger sizes available by Special Order. Please call for pricing.



**THE TACKER BY ATN**

The Tacker was developed by ATN to control the tack of a cruising spinnaker without chafe or damage, by loosely fastening it over the furled headsail. The rigid and smooth design of the Tacker spreads the undesirable side loads and keeps the luff of the cruising spinnaker close to the bow.

Item	Description	Boat Size	Ship	Net
612381	SIZE A 50' headstay	to 33'	1 lbs	\$139.99
612382	SIZE B 75' headstay	to 45'	2 lbs	179.99
612383	SIZE C 100' headstay	Over 45'	3 lbs	229.99



**RUBBAWELD RIGGING & MAST BOOT TAPE**

Works well at covering exposed cotter pins or sharp objects that may harm sails, lines or people. Bonds to itself and makes one solid piece. Can be used on hot objects for an emergency repair, such as radiator hoses.

Item	Model	Size	Color	Ship	Net
615420	50-115	1" x 15'	White	1 lbs	\$16.99
	50-115B	1" x 15'	Black	1 lbs	16.99



**RUBBAWELD MAST BOOT TAPE**

An all-purpose, self-amalgamating marine tape that welds to itself by chemical action to form a solid, waterproof skin. 4" W x 10' L. Temperature range -40° C to +100° C. Can be used on hot objects for an emergency repair on radiator hoses, etc.

Item	615101	50-405	Ship 1 lbs	Net \$25.99
------	--------	--------	------------	-------------

**3M 35 VINYL TAPE**

Used for rigging. Highly conformable and super-stretchy in all weather applications. Tape resists UV rays, abrasion, corrosion, alkalis and acids. Flame retardant. Color: White. Sold per roll.

Item	Model	Size	Ship	Net
204328	10828	7 mils x 3/4" x 66'	1 lbs	\$6.59

**LIFESAPE RIGGING TAPE**

Self-bonding rigging tape protects against chafing and sharp edges while providing extraordinary safety for sails, lines, etc.

Item	Model	Description	Ship	Net
612249	RE3867	1" W x 15' L, White	1 lbs	\$14.99
614516	RE3866	1" W x 15' L, Black	1 lbs	13.99

For Mast boot tape from Lifesafe please see page 94.

**BAINBRIDGE RIPSTOP NYLON REPAIR TAPE**

Self adhesive ripstop repair tape.

Please specify: White, Red, Blue, Light Blue, Black, Gold, Hot Pink, Silver or Green

Item	Width	Average Length	Ship	Net
607467	2"	25'	1 lbs	\$13.99

**LIFESAPE CLEAR SAIL PATCH REPAIR TAPE**

Super clear, ultra strong, UV stabilized. Aggressive adhesive even works on damp sails.

Item	Model	Description	Ship	Net
612250	RE3843	3" W x 15' L	1 lbs	\$16.99
755725	RE1175	6" W x 10' L	1 lbs	22.99

**SAIL CLOTH ADHESIVE-BACKED TAPE**

Highest quality insignia dacron 4 oz., perfect for spreader patches and repairs of tears on genoas and mainsails. White.

Item	Model	Width	Length	Ship	Net
612626	INT2P	2"	50 yard roll	2 lbs	\$44.99
612627	INT18P	18"	Sold per yd.	1 lbs/yd.	12.99/yd.



**Clevis Pins, Cotter Pins, Cotter Rings**

**STAINLESS CLEVIS PINS**

All ship 1 lbs.

Item	Dia.	Grip	Head	Per Pkg	Net
607512	3/16"	1/2"	5/16"	2	\$4.89
607492	3/16"	39/64"	5/16"	2	4.99
607494	3/16"	55/64"	5/16"	2	4.99
607495	3/16"	1-1/16"	5/16"	2	4.99
607496	1/4"	3/4"	3/8"	2	5.69
607498	1/4"	55/64"	3/8"	2	5.69
607500	1/4"	1-7/64"	3/8"	2	5.69
607502	5/16"	1"	7/16"	1	5.29
607503	5/16"	1-1/4"	7/16"	1	4.99
607504	5/16"	1-1/2"	7/16"	1	4.89
607505	5/16"	1-25/32"	7/16"	1	4.99
607516	3/8"	23/32"	1/2"	1	4.99
607506	3/8"	1-1/64"	1/2"	1	5.99
607507	3/8"	1-1/2"	1/2"	1	5.49
607508	3/8"	2"	1/2"	1	6.29
607509	1/2"	1-1/64"	5/8"	1	6.89
607510	1/2"	1-17/64"	5/8"	1	6.99
607519	1/2"	1-13/64"	5/8"	1	6.69

LARGER PINS AVAILABLE AT DEFENDER.COM

**STAINLESS COTTER PINS**

All ship 1 lbs.

Item	Size	Per Pkg	Net
607521	1/16" x 3/4"	12	\$2.49
607522	1/16" x 1"	12	2.99
607525	3/32" x 5/8"	10	2.99
607526	3/32" x 3/4"	10	2.99
607527	3/32" x 1"	4	2.99
607528	3/32" x 1-1/2"	4	2.99
607530	1/8" x 3/4"	4	2.99
607531	1/8" x 1"	4	2.99
607532	1/8" x 1-1/4"	4	2.99
607533	1/8" x 1-1/2"	4	2.99
607534	1/8" x 1-3/4"	4	2.99
607535	1/8" x 2"	2	2.99

**STAINLESS COTTER RINGS**

All ship 1 lbs.

Item	Clevis Pin	Dia.	Pkg	Net
607536	3/16"	3/8"	8	\$2.99
607537	1/4"	5/8"	6	2.49
607538	5/16"	3/4"	4	2.49
607539	3/8"	7/8"	4	2.99
607540	1/2"	1-1/8"	4	2.99
607541	5/8"	1-3/16"	4	2.99

**C. S. JOHNSON WRAP PIN**

• Velcro locking device

• Secure turnbuckle without cotter pins

Item	Dia.	Threads	Net/Pair
606930	3/32"	5/16" and 3/8"	\$12.99
606931	1/8"	7/16", 1/2" and 5/8"	14.99



See Page 70 for Quick Lock Pins



**SEA-DOG STAINLESS STEEL MAINSAIL HOOKS** Ship 1 lbs.

Item	Model	Dia. x Length	Net
612171	195410-1	5/16" x 3-3/4"	\$7.49

**SCHAEFER STAINLESS STEEL CUNNINGHAM HOOKS** Ship 1 lbs.

Item	Model	Dia. x Length	Net
603298	76-45	1/4" x 2-5/8"	\$28.99
603299	76-46	5/16" x 3-7/8"	\$15.99

**SEA-DOG STAINLESS STEEL REEF HOOKS** Ship 1 lbs.

Item	Model	Stock Dia. x Length	Net
612167	195310-1	5/16" x 2-1/2"	\$6.49
612164	195320-1	3/8" x 3-1/2"	8.49

**SEA-DOG STAINLESS STEEL TACK/LASHING HOOKS** Ship 1 lbs.

Item	Model	Stock Dia. x Length	Net
612165	195210-1	5/16" x 2-3/4"	\$5.99

**BARTON MARINE 52 100 STANCHION CLEAT** Ship 1 lbs.

Attaches to stanchions or pushpit/pullpit tubes.

Item	Model	Description	Net
606947	52 100	Soft nylon jaws	\$23.99

**ALADDIN SHROUD CLEAT** Ship 1 lbs.

Mounts easily on any shroud, wire or rod from 3/16" to 5/16" diameter. Black hard anodized aluminum with stainless steel fasteners.

Item	Model	Ship	Net
612215	0110	No screws needed	\$19.99

**JOHNSON STAINLESS STEEL SHROUD CLEAT**

Easily attaches to 5/32" through 3/8" diameter wire or rod. Includes an eye for attaching a snap shackle. Low profile - projects only 1/2" from the shroud.

Item	Model	Ship	Net
614158	40-518	1 lbs	\$18.99

**SCHAEFER 45-06 OPENING PRE-FEEDER**

Forged aluminum opening pre-feeder. Works with #5 and #6 luff tapes. Allows quick engagement of your luff tape at anytime.

Item	Model	Ship	Net
609000	45-06	1 lbs	\$64.99

**RONSTAN STAINLESS STEEL SISTER CLIPS** Ship 1 lbs.

Effective means of quickly attaching and detaching ropes.

Item	Model	Length	Size	Load	M.A.P.
601539	RF536	15/16"	9/32"	1 lbs	\$3.95
601281	RF89	1-7/16"	13/32"	1 lbs	5.95

**SCHAEFER TUFF LUFF PRE-FEEDER**

Oversize silicon bronze rollers made of heavy duty construction.

Item	Model	Ship	Net
603632	1205-01	1 lbs	\$81.99

**SPINLOCK SAIL PREFEEDER**

Graphite loaded, anodized alloy rollers.

Item	Model	Luff Feeder	Ship	Net
608521	RF/H	Headsail	1 lbs	\$74.99
608670	RF/MA	Mainsail	1 lbs	76.99

**PROFURL WICHARD OPENING PRE-FEEDER**

Stainless steel. Designed for foils and furlers. Single handed operation - no need to remove the headsail.

Item	Model	Ship	Net
614324	07485	1 lbs	\$90.99

**SAIL TIES - 4 STRAPS PER BAG**

Snap the buckle and pull the strap. Offers many uses.

Item	Model	Description	Ship	Net
752534	585040	5' long polypropylene	1 lbs	\$19.99

Note: Not for safety harness

**BLUE PERFORMANCE SAIL CLIPS** 3 per pack. All ship 1 lbs.

Item	Model	Dimensions	Color	Net
608276	BP300	8.7" - 13.4"	Gray/Yellow	\$54.99
	BP310	11.0" - 18.5"	Gray/Blue	58.99
	BP320	14.2" - 23.2"	Gray/Red	64.99
	BP330 (1)	each of BP300, BP310, BP320		68.99

**WHITECAP ADJUSTABLE JAW BUNGEE - 10 PACK**

• Length: 12". Color: Black • No-slip 1" jaw ball for adjusting length  
• Bungees can be connected to each other to extend length

Item	Model	Ship	Net
756923	JB-100716B	1 lbs	\$11.99



**RONSTAN SAIL SLUGS** - All ship 1 lbs.

Compression sail slug with stainless steel attachment loop.

Item	Model	Stock Dia. x L	Net
608827	PNP102	5/16" x 1-3/4"	\$3.99
	PNP103	3/8" x 1-13/16"	3.99
	PNP104	1/2" x 2"	3.99

**RONSTAN SAIL SHACKLE** - All ship 1 lbs.

Screw-on 12 mm (1/2") deep x 8 mm (5/16") clearance.

Item	Model	Net
601123	PNP63	\$1.89

**RONSTAN PACIFIC PISTON HANK** - All ship 1 lbs.

Piston hank, suits 11.2 mm (7/16") diameter wire, 75 mm (3") long.

Item	Model	Net
601147	PNP88C	\$13.99

**RONSTAN SAIL SLIDES** - All ship 1 lbs.

Sail slide with internal track.

Item	Model	W x L	Net
608828	PNP27T	5/8" x 1-1/4"	\$1.89
	PNP28T	7/8" x 1-5/8"	1.89

**WICHARD "KNOCK ON" SAIL SNAPS** - All ship 1 lbs.

Bronze snaps attach jib to headstay. Open end attaches to grommet or sail and is hammered closed.

Item	Model	Length	Fits Wire	Net
612277	72486	2"	5/16"	\$6.49
612278	72483	2-5/32"	3/8"	7.49
612279	72487	2-9/16"	7/16"	9.49

**SCHAEFER SAIL TRACK**

Used on masts and booms for high strength sail leads.

**Sail Track-Type 304SS**

Item	Model	Track Length	Ship	Net
603290	75-05-144	5/8" x 12'	2 lbs	\$81.99
603292	75-07-144	7/8" x 12'	3 lbs	96.99

**Track End Stops**

Item	Model	Ship	Net
603231	74-05	5/8"	1 lbs \$23.99
603230	74-02	7/8"	1 lbs 23.99

Track end stops fit over end of track. Non-adjustable once installed. Sold each.

**SHROUD ROLLERS**

White ash. Fits wire up to 5/16" diameter.

Item	Model	Dimensions	Ship	Net/Pair
612173	514SRUA	OD: 1-1/4"; 5' L	4 lbs	\$76.99

**DAVIS CABLE COVERS**

Protects sails and sheets. Covers are slit for easy installation. Tough and durable. 6' long.

Inside				Outside			
Item	Model	Ship	Net	Item	Model	Ship	Net
612143	252	1/8"	1 lbs \$2.49	612145	255	1/4"	1 lbs \$3.99
614313	253	5/32"	1 lbs 2.99	612146	256	5/16"	1 lbs 4.59
612144	254	3/16"	1 lbs 3.59	612147	257	3/8"	1 lbs 4.99

**SCHAEFER ROUND UTILITY RINGS**

Welded from stainless steel rod; tumbled and polished to a high luster finish. Welds are hand sanded and buffed to a smooth surface to help avoid chafe and abrasion.

Item	Model	Stock Dia.	Inside Dia.	SWL	Ship	Net
608839	94-01	3/16"	3/4"	1500 lbs	1 lbs	\$19.99
	94-02	3/16"	1"	1500 lbs	1 lbs	19.99
	94-03	3/16"	1-1/4"	1500 lbs	1 lbs	20.99
	94-21	1/4"	1"	2000 lbs	1 lbs	24.99
	94-22	1/4"	1-1/2"	2000 lbs	1 lbs	26.99
	94-23	1/4"	2"	2000 lbs	1 lbs	27.99
	94-41	3/8"	2-1/2"	2500 lbs	1 lbs	52.99
	94-42	3/8"	3-1/4"	2500 lbs	1 lbs	58.99

**ANDERSEN BAILERS**

For sailboats, canoes, dinghies and shells. Designed specially for performance dinghies where weight is of major concern.

All ship 1 lbs.

Item	Style	Mounts	Fitting Hole	Hull Thickness	M.A.P.
608855	Mini	Outside	1-1/2" x 2-7/8"	any size	\$79.95
	Super Mini	Inside	1-9/16" x 3-11/32"	1/8" - 9/32"	105.95
	Super Med.	Inside	1-11/16" x 4-11/32"	1/8" - 9/32"	105.95
	Super Max.	Inside	2-1/8" x 4-11/32"	1/4" and larger	125.95
	Large	Outside	1-5/8" x 4-11/16"	1/4" and larger	133.95

**MCLUBE SAILKOTE DRY LUBRICANT**

Ultra-slick, long lasting, environmentally-friendly dry lubricant that repels water, salt, dirt, dust, sand and grime. For use on mast tracks, sliding hatches and drawers, all deck gear, even tell-tales. Check out www.mclube.com for specific onboard applications.

Item	Model	Size	Ship	Net
608710	8OZ	8 oz. spray	1 lbs	\$14.99
367104		Quart	2 lbs	42.99
367110		Gallon	8 lbs	139.99



**MCLUBE LUBRICANTS**

**ONEDROP BALL BEARING CONDITIONER**

OneDrop Ball Bearing Conditioner is designed to be used on traveler cars and other ball bearing applications to improve performance by reducing rolling friction. Packaged in a unique pinpoint dispenser for clean and easy application.

Item	Model	Description	Ship	Net
600934	7875	0.5 Fl oz.	1 lbs	\$12.99



## Whisker Poles

### FORESPAR® TRI REACHER™ WHISKER POLE

This pole has been developed specifically for use with asymmetrical nylon sails.

- Use of a whisker pole with these sails will allow deeper sailing angles and eliminate the need for constant jibing downwind
- On long downwind legs, the additional rigging of fore and after-guys (attached to the outboard end) will further stabilize the pole
- The inboard ends are "UTS" style socket end or "UXP" piston style
- The outboard end is the "UXP" style
- Toggle/knuckle pin assemblies can be used on other brands of mast cars such as Harken, Selden, Isomat and others (They require a 1/2" hinge pin or bolt and 1" space between flanges/tabs)
- Typical boat size 31' - 40'

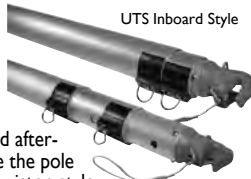

Item	Model	End Fittings	Usable Length	Tube Diameters	Ship	Net
D 61535*	408200	UTS/UXP	8'8" -20'8"	3", 2-7/8", 2-1/2"	90 lbs	\$862.99
D 615361*	408201	UXP piston style/UXP	8'8" -20'8"	3", 2-7/8", 2-1/2"	90 lbs	862.99

\* Additional shipping handling fee

### Mount Brackets-Stainless Steel

Item	Model	Description	Ship	Net
615359	333025	Fixed mast toggle	4 lbs	\$281.99
615360	332025	Fixed mast flange	5 lbs	287.99

### FORESPAR VELOCITY SERIES CARBON FIBER WHISKER POLE

- Designed to maximize downwind sailing efficiency for racers or cruisers
- Includes Marelon® lightweight and non-marring UXP composite pole ends
- Quickly deployable; retract as needed with a simple pull of a line

Item	Model	Boat size	Pole Length	OD	Ship	Net
607464	800803	Up to 36'	12'-22' Adjustable	2" and 3"	32 lbs	\$2329.99
607465	800804	Up to 44'	13'-24' Adjustable	2.5" and 3.5"	35 lbs	3049.99



### FORESPAR SMALL TELESCOPING TWIST LOCK WHISKER POLE

Telescoping models can be adjusted to desired length and securely locked in position with an effortless twist of the inner tube. All small poles include strong, corrosion-free Lexan® end fittings and a mast pad eye with stainless steel screws.

Item	Model	Description	Max. Boat Size	Ship	Net
600442	404000	Usable length 53"-93", 1" O/D spike on one end	16'	2 lbs	\$101.99
600447	404100	With latch fittings on both ends	16'	2 lbs	113.99
600459*	406000	Usable length 72"-134", 1.25" O/D	22'	3 lbs	139.99
600466*	406100	With latch fittings on both ends	22'	3 lbs	148.99



### FORESPAR TWIST LOCK WHISKER POLE

Features self-latching Ultra Series™ Easy Latch fittings on the inboard and outboard ends. For boats 16'-25'; 2-part pole extends: 6'-12' (79" - 138"). Outer tube dia: 1.875".

Item	Model	Ship	Net
600472*	406300	5 lbs	\$372.99

Features Ultra™ UXP (external) end fittings with Forespar's patented Easy Latch. Recommended boat size to 25'. 3 part pole extends 7'-15'. Outer tube dia: 2".

Item	Model	Ship	Net
600050*	407101	7 lbs	\$426.99

\* Additional shipping handling fee

### FORESPAR LINE CONTROL WHISKER POLE

Line Control® poles are heavy-duty, two-section aluminum spars which can be extended up to 27' by simply unlatching the line at the inboard end, extending or retracting the pole to the desired length and re-cleating the line. This adjustment process is quick and easy, even with the largest pole, and is executed with the operator positioned safely at the mast. See Forespar End Selection Guide at upper right for end fittings.



See Forespar End Selection Guide at upper right for end fittings.

Item	Model	End Fittings	Length	Recommended Tube		Ship	Net
				Mast Fittings	Dia. & 2.5"		
600412	401106	EL/UXP	10'-18'	PE-35C, RC-125, FC-125	2" & 2.5"	21 lbs	\$949.99
600413	401107	EL/UTR	10'-18'	PE-35C, RC-125, FC-125	2" & 2.5"	21 lbs	989.99
600429	402200	UXP/UTR	12'-22'	RC-125, FC-125	2.5" & 3"	32 lbs	1280.99
600430	402201	UTS/UTR	12'-22'	T-125-S	2.5" & 3"	32 lbs	1613.99
600440	403200	UXP/UXP	13'-24'	RC-125, FC-125	3" & 3.5"	49 lbs	1772.99
600441	403202	UTS/UTR	13'-24'	T-125-S	3" & 3.5"	48 lbs	1830.99
600457	405200	UTS/UXP	15'-27'	T-125 S	3.5" & 4"	70 lbs	2109.99
600458	405201	UTS/UTR	15'-27'	T-125 S	3.5" & 4"	67 lbs	2109.99

### FORTE CARBON FIBER TELESCOPING WHISKER POLE

4-axis continuous fiber braiding technology produces a light, yet extremely strong pole. Forte's process yields a stronger and more impact-resistant part than a typical "rolled" or "laid-up" carbon fiber part because a braided part has continuous fiber strands and no seams to delaminate. Each pole is fully rigged with Forespar ends.

Item	Model	End Fittings	Length	Tube		Ship	Net
				In/Out	Dia.		
600833	TW-2.5	UXP250/UXP150	12'-22'	1.75"/2.5"	14 lbs	\$2370.99	
600834	TW-3.0	UTS300/UTR250	15'-27'	2.25"/3.0"	19 lbs	3130.99	
600835	TW-4.0	UTS300/UTR300	16'-28'	3.0"/4.0"	32 lbs	3510.99	



## Forespar End Selection Guide



### FORESPAR "ULTRA SERIES™" END FITTINGS

Designed for high strength, very low weight and resistance to wear and corrosion, the "Ultra Series" composite end fitting is perfect for aluminum or carbon fiber spinnaker poles and whisker poles. UTR adjustment screw for light air. TS aluminum available by special order.

Item	Model	End	Weight	For Pole OD	Fitting length	Ship	Net
600259	304050	UXP	6.97 oz.	2.0"	2.75"	1 lbs	\$118.99
600263	304060	UTR	6.97 oz.	2.0"	2.75"	1 lbs	146.99
600260	304051	UXP	9.25 oz.	2.5"	3.125"	1 lbs	134.99
600264	304061	UTR	9.25 oz.	2.5"	3.125"	1 lbs	171.99
600261	304052	UXP	11.92 oz.	3.0"	3"	1 lbs	144.99
600265	304062	UTR	11.92 oz.	3.0"	3"	1 lbs	191.99
600267	304080	UTS	20.00 oz.	3.0"	2.835"	2 lbs	380.99
600262	304053	UXP	15.72 oz.	3.5"	3.625"	2 lbs	201.99
600266	304063	UTR	15.72 oz.	3.5"	3.625"	2 lbs	234.99

### FORESPAR MAST AND TRACK FITTINGS



Item	Model	Style	Description	Type	Ship	Net
607847	400001	PE-3SF	Stainless 1.625" eye	Flat base	1 lbs	\$48.99
	400002	PE-3SC	Stainless 1.625" eye	Curved base	1 lbs	48.99
	400012	PE-3-SF	Stainless 1.625" eye	Flat base with struts	1 lbs	57.99
600335	331000	RC-125	1.25" T-track ring car	Stainless steel	1 lbs	121.99
600338	332002	FC-125	Heavy duty car; fits 1.25"x.1875" flat T-track for UTR and UXP end fittings		3 lbs	389.99
600803	331013	NA	Replacement runners for 1-1/4" and 1-1/2" Forespar toggle cars, sold in pairs		1 lbs	22.99
600342	333004	T-125	Toggle car; fits 1.25" x .1875" flat T-track for TS/UTS end fittings		3 lbs	607.99
600343	333010	TS Toggle Assy.	Replacement toggle and knuckle; for T125 toggle cars		2 lbs	279.99

## Pole Storage

### FORESPAR VERTICAL POLE STORAGE CAR

- Can be used with the FC-125 (model 332002) mast car
- Stores pole on the mast centerline keeping deck spaces clear
- For 1-1/4" T track

Specify pole diameter: 2.5", 3", 3.5" or 4"

Item 608850 Starting at \$156.99



### FORESPAR MAST CHOCK

- Molded from durable, high tech urethane
- Allow for stowing the pole vertically against the face of the mast

Specify Pole Diameter: 2", 3", 3.5" or 4"

Item 608851 Starting at \$65.99



### FORESPAR STANCHION MOUNTED POLE CHOCK

- Constructed of high tech, weather-resistant urethane molding
- Chocks sold individually - (2) two chocks needed for each pole
- For 1" stanchions

Specify Pole Diameter: 2", 2.5", 3" or 3.5"

Item 608852 Starting at \$49.99



### FORESPAR MARELON DECK CHOCK

- Stow spinnaker poles or whisker poles on the deck
- For rugged use and a "snag proof" low profile

Item	Model	Description	Ship	Net
600124	300002	Ultra for UXP, UTR, GP and UGPS end fittings	1 lbs	\$61.99
615090	300013	Ultra for TS and UTS end fittings	1 lbs	71.99



### FORESPAR MARELON REPLACEMENT CLEAT

- Molded from high-strength Marelon
- Fastener holes: (2) 1/4"

Item	Model	Size	Ship	Net
600985	941014	6.5"	1 lbs	\$7.49
600986	941015	8"	1 lbs	10.99



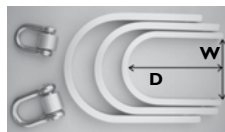

**BOOMKICKER BOOM BAILS**

Rolling Bails™ for booms and masts provide a low friction rolling connection to the mainsheet or vang. Designed to keep the shackle in rolling position. Anodized aluminum bail and stainless steel roller. Improve existing round bar bails with the RSSR17 bail roller. Mounting bolts not included. All ship 1 lbs.



RSSR17

Item	Model	Description	M.A.P.
614695	R057-082	2.25" W x 3.25" D	\$29.32
614696	R064-095	2.50" W x 3.75" D	29.32
614697	R067-095	2.62" W x 3.75" D	29.32
614698	R070-095	2.75" W x 3.75" D	29.32
614705	RSSR17	Bail roller with shackle	26.35

**SCHAEFER STAINLESS STEEL TANGS**

Item	Model	Length	Width	Thick	Hole Dia.	Ship	Net
603387	85-03	8"	1"	3/32"	1/4"	1 lbs	\$25.99
603394	85-22	12"	1/2"	1/16"	3/16"	1 lbs	26.99
603403	85-32	12"	3/4"	1/16"	3/16"	1 lbs	33.99

**SCHAEFER BOOM BAILS** Use 1/4" round head fasteners.

Item	Model	Dimensions	Ship	Net
603406	90-04	1-5/8" x 1-3/4"	1 lbs	\$19.99
603405	90-01	1-3/4" x 3-1/2"	1 lbs	20.99

**SCHAEFER FORGED STAINLESS BOOM BAILS** All ship at 1 lbs.

Item	Model	Size (W x L)	Net	Item	Model	Size (W x L)	Net
603412	90-27*	2-1/4" x 3"	\$50.99	603407	90-07+	3" x 5"	\$54.99
603410	90-10+	2-1/4" x 3-3/4"	50.99	603408	90-08+	3-3/4" x 4"	54.99
603413	90-28*	2-3/4" x 3-1/2"	49.99	603411	90-12+	5-3/4" x 8-3/8"	78.99
603409	90-09+	2-3/4" x 3-3/4"	51.99				

\* Uses 3/8" round head fasteners.  
\* Uses 1/4" round head fasteners.

**RONSTAN BOOM BAIL**

316 stainless steel. Inside bail: 4"W. Outside bail: 4-1/2"W.

Item	Model	Length	Ship	M.A.P.
601744	RF1048	6"	1 lbs	\$41.95

**SCHAEFER DEAD END BAIL** All ship at 1 lbs.

Item	Model	L" x W" x H"	Weight	Net
603333	78-93	1 x 7/16 x 9/16	1 oz.	\$17.99
603332	78-92	1-1/2 x 7/16 x 11/16	1 oz.	17.99

**RONSTAN STAINLESS EXIT PLATES**

Most exit plates reduce abrasion of halyards and other control lines as they pass through exit slots in spars.

Item	Model	Slot Width	Length	Width	Ship	M.A.P.
602382	RF6031	3/8"	6-1/4"	13/16"	1 lbs	\$18.95
602383	RF6032	1/2"	8"	1"	1 lbs	19.95
602384	RF6033	11/16"	8-1/4"	1-1/8"	1 lbs	22.95

**SCHAEFER HALYARD EXIT PLATE**

Stamped, polished stainless steel. Economical alternative to exit sheave box or open slot. Eliminates halyard chafing.

Item	Model	Shape	Max Line	Cutout	Ship	Net
602789	34-46	Flat	1/2"	2-1/4" x 13/16"	1 lbs	\$23.99
602790	34-48	Flat	3/4"	3-1/4" x 1"	1 lbs	46.99
602791	34-49	Curved	3/4"	3-1/4" x 1"	1 lbs	50.99

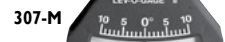
**SUN CO. CLINOMETERS** All ship 1 lbs.

Item	Model	Description	Net
601093	7301-C	Shows angle of heel from -45° to 45°, 3.5" W x 1.6" H	\$15.49
601091	303-M	Shows angle of heel from -50° to 50°, 6.4" W x 2.9" H	22.49
601092	307-M	Shows angle of pitch from -10° to 10°, 3.5" W x 1.5" H	15.99

**C.S. JOHNSON INNER FORESTAY STORAGE BRIDLE**

Welded 316 stainless steel plate design with center bracket.

Item	Model	Length	Ship	Net
601234	49-250	12"	3 lbs	\$155.99

**C.S. JOHNSON ADD-A-CLEAT**

- Stainless steel mount with nylon coated aluminum cleat
- Included hose clamp fits 7/8" and 1" tubing

Item	Model	Length	Ship	Net
606522	40-506	4-1/2"	1 lbs	\$22.99

**C.S. JOHNSON STAY ADJUSTER- Quick Release**

Developed for dry sailed, one-design dinghies. When pin is pulled, an easy adjustment and unrigging can be obtained. Chain plate pin: 1/4", Max. wire size: 1/8", Pin to pin adjustment: 1-3/4" to 3-5/8".

Item	Model	Size	Ship	Net
613702	15-212	3/16" Wire terminal pin	1 lbs	\$31.99

**Lazy Jack & Reefing Kits****SCHAEFER MARINE****SCHAEFER LAZY JACK SYSTEMS**

To properly secure the sail when you are moored, Lazy Jack "funnels" the sail down to the boom and retains it, keeping you safe in the cockpit. The design allows for the use of an existing sailcover without the need for extensive modifications. Each kit includes: fasteners, eye straps, open base cleats, lashing eye blocks with elkhide, chafe guards, vinyl coated wire and Dacron yacht braid with eye splices.

Item	Model	Boom Length	Boat Length	Legs	Ship	Net
600045	99-62	8' - 10'	24' - 29'	2	3 lbs	\$291.99
600058	99-63	10' - 12'	30' - 36'	2	4 lbs	298.99
600059	99-64	12' - 16'	37' - 48'	3	8 lbs	558.99

**SCHAEFER JIFFY REEFING LEAD CAR WITH BLOCK AND DEAD END-BAIL**

Stainless steel slider with aluminum cheek and Delrin® sheave

Item	Model	Boats Up To	Track	Ship	Net
603225	73-37	30'	1" x 1/8"	1 lbs	\$125.99

**RONSTAN 30 MM CLEW RING BLOCK**

- Clew ring linked with (2) single blocks
- Mainsheet systems and spinnaker sheets on dinghies to 16'
- Halyard, vang and backstay applications on boats to 16'
- Control line applications on larger yachts



Item	Model	Safe Working Load	Breaking Load	Weight	Sheave Dia.	Max. Line Size	Ship	M.A.P.
615276	RF35286	660 lbs	1320 lbs	2.2 oz	1-3/16"	5/16"	1 lbs	\$33.95

**HARKEN LAZY JACK KITS**

Kit includes pre-swaged, vinyl-coated stainless steel cable, ball bearing blocks, eyestraps, line, cleat, fasteners and pictorial instructions.

Item	Model	Boom Length	Boat Length	Ship	Net
604883	252	7' - 13'	21' - 28'	3 lbs	\$282.99
604884	253	10'6" - 16'	27' - 37'	5 lbs	386.99
604885	254	12' - 16'	35' - 42'	8 lbs	594.99

**BARTON LAZY JACK KITS**

All rope kit, anti-chafe block covers. Blocks, cleats, mounting eyes and fixings included.

Item	Model	Description	Fits Boats Up to	Ship	Net
602146	41 140	Lightweight	30'	4 lbs	\$195.99
602147	41 143	Lightweight cascade	35'	6 lbs	267.99

**BARTON SLAB REEFING KIT**

- (3) Sliding reefing blocks with spring-loaded plungers, made from stainless steel and "Spectro" anodized aluminum
  - 100 cm (39.37") of 32 mm anodized "T" track
  - 1 pair plastic end caps
- | Item   | Model  | Fits Boats up to | Ship  | Net      |
|--------|--------|------------------|-------|----------|
| 602144 | 41 496 | 39'              | 4 lbs | \$229.99 |
- Note: Requires Countersunk machine screws, eye straps, line, (3) cleats, (3) reefing hooks

**BARTON SINGLE LINE REEFING KIT**

- (1) Reefing slide on 25 mm "T" track with end fittings (No.1)
  - (2) Eye straps (No.2), (1) tang block (No.3), (1) bullseye (No.4), (1) mast base block (No.5), rivets and machine screws
- | Item   | Model  | Fits Boats Up to | Ship  | Net      |
|--------|--------|------------------|-------|----------|
| 602145 | 41 130 | 30'              | 2 lbs | \$193.99 |
- Note: Requires: (4) 1/4" countersunk machine screws, penny washers or backing pad (not provided as deck thickness may vary). Reefing line and cleat also required.

**EDSON LEATHER TURNBUCKLE COVERS**

- Adds a distinctive look while protecting your lines and sails from the premature wear
- More durable than plastic and tape
- Attached and removed easily with pre-fastened, industrial grade hook-and-loop strips.

Item	Model	Turnbuckle Size	Dimensions	Ship	Net
614673	1405-12	Small, 5/16"	1" x 12"	1 lbs	\$36.99
614674	1405-14	Medium, up to 1/2"	1.5" x 18"	1 lbs	45.99
614675	1405-24	Large, 5/8"	1.75" x 24"	1 lbs	54.99

**ATN MASTCLIMBER**

Allows you to get up your mast safely and quickly, using your leg muscles, without any outside help, even when the boat heels. Open the ATN ascender to fit it directly over the halyard, so there is no need for an extra static line.

- Rugged and simple construction ensures years of use
- A Bosun's chair with back support • (2) ATN ascenders
- Ascender leg straps with loops for the feet
- Ascender bag which can be used as a tool bag

Item **614392** Ship 5 lbs **Net \$399.99**

**BOSUN CHAIR CONVERSION KIT – Transform your chair into a mastclimber**

(2) ascenders, foot strap and upper extension

Item **614394** Ship 2 lbs **Net \$264.99**

**HARKEN BALLISTIC NYLON DELUXE BOSUN'S CHAIR**

- Stainless steel triangle attachments • High-strength webbing
- One D-ring attachment on each side for tools or parts
- Two webbing attachment points per side
- Extra wide padded seat and adjustable back support
- Wide-mouth pockets on each side • Max capacity: 220 lbs
- Downhaul attachment on bottom of chair

Item **615159** Model **2234** Ship 5 lbs **Net \$169.99**

**PLASTIMO COMFORT® BOSUN'S CHAIR**

- Back strap and crotch piece will prevent you from falling out
- Designed so that the angle of the chair can be adjusted, allowing you to find the most comfortable, safe working balance between back and legs
- Equipped with 2 pockets • Size of seat: 15" x 7"
- Safe working load 220 lbs

Item **615023** Model **10470** Ship 3 lbs **Net \$149.99**

**SPINLOCK MAST PRO HARNESS**

Extremely lightweight, minimal design. Super slim structured waist belt spreads the load evenly over its full width for comfort with reduced bulk. Unique ratchet-fit adjustment on leg straps for a secure, easy fit. Ergonomic sculptured waist belt and wide leg straps for added comfort and lumbar support. Designed for use in the marine environment. Marine grade stainless steel 'doubleback' buckles. Neoprene buckle covers prevent snagging and rig damage

Item **600044** Model **DW-MPH** Ship 2 lbs **Net \$139.99**

**BLUE PERFORMANCE RAIL BAG**

Convenient storage for lines or miscellaneous items. Mounts to your lifelines. Made with ripstop material which makes this bag very durable. Includes a mesh bottom for water drainage. Color: Gray ripstop material.

Item	Model	Dimensions (L x H x D)	Ship	Net
<b>608902</b>	<b>BP3490</b>	13.8" x 9.8" x 2.8"	2 lbs	<b>\$75.99</b>

**BLUE PERFORMANCE BULKHEAD SHEET COMBI BAG**

Reduces clutter while underway. Mounts on (4) hooks secured with screws (Hardware included). Color: Gray ripstop material

Item	Model	Dimensions (L x H x D)	Ship	Net
<b>608906</b>	<b>BP3500</b>	13.8" x 9.8" x 3.9"	2 lbs	<b>\$70.99</b>
	<b>BP3505</b>	15.2" x 10.8" x 4.3"	3 lbs	<b>74.99</b>
	<b>BP3510</b>	16.5" x 11.8" x 4.7"	3 lbs	<b>84.99</b>

**BLUE PERFORMANCE BULKHEAD SHEET BAG**

The perfect way to deal with that tangled mass of halyard and sheet tails that pile up in the cockpit. Color: Gray ripstop material

Item	Model	Dimensions (L x H x D)	Ship	Net
<b>608907</b>	<b>BP3450</b>	11.8" x 7.9" x 2.9"	2 lbs	<b>\$54.99</b>
	<b>BP3460</b>	13.8" x 9.8" x 2.8"	2 lbs	<b>59.99</b>
	<b>BP3470</b>	15.7" x 11.8" x 2.8"	3 lbs	<b>69.99</b>
	<b>BP3475</b>	13.8" x 15.7" x 2.8"	3 lbs	<b>69.99</b>

**BLUE PERFORMANCE MAST SHEET BAG**

Attaches to the mast using webbing straps. The design allows halyards to exit from the top of the bag while instant access is available via a velcro flap at the front. Color: Gray ripstop material

Item	Model	Dimensions (L x H x D)	Ship	Net
<b>608258</b>	<b>BP550</b>	5.9" x 17.7" x 4.3"	2 lbs	<b>\$61.99</b>
	<b>BP555</b>	6.9" x 23.6" x 5.1"	2 lbs	<b>69.99</b>
	<b>BP560</b>	8.3" x 27.6" x 5.9"	3 lbs	<b>84.99</b>

**FORESPAR® LIGHTNING MASTER™ STATIC DISSIPATER**

The Lightning Master reduces the buildup of static ground charge and retards the formation of the ion streamers, which complete the path for a lightning strike. A dissipater employs the point-discharge principal - to continually leak off the lightning, causing ground potential in low amp dissipation over a long period of time rather than short duration, high amperage discharge that occurs with a lightning strike.

Item	Model	Ship	Net
<b>252171</b>	<b>151100</b>	1 lbs	<b>\$149.99</b>

**SPARTITE 2000 MAST WEDGE REPLACEMENT SYSTEM**

Pre-measured, two part polymer that comes with complete instructions and materials you need to build a simple mold. Spartite makes a one piece, perfect fitting mast chock that replaces archaic wedges. Comes standard in Midnight Blue color.

Item	Model	Description	Ship	Net
<b>614528</b>	<b>KIT #1</b>	51 cu. in. of cured product	6 lbs	<b>\$124.99</b>
<b>614529</b>	<b>KIT #2</b>	102 cu. in. of cured product	8 lbs	<b>174.99</b>

**LIFESAFE MASTBOOT TAPE**

Installing mastboot does not require unstepping the mast. It bonds itself into a solid piece of rubber, offering protection against moisture. Conforms to irregular surfaces. Leaves no sticky residue.

Item	Model	Size	Ship	Net
<b>612247</b>	<b>RE3940</b>	4" W x 40" L	1 lbs	<b>\$19.99</b>
<b>612248</b>	<b>RE3941</b>	4" W x 100" L	1 lbs	<b>37.99</b>

FOR RIGGING TAPE PLEASE SEE PAGE 90

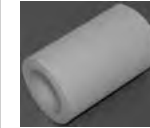
**RUBBAWELD MAST BOOT TAPE**

An all-purpose, self-amalgamating marine tape that welds to itself by chemical action to form a solid, waterproof skin. 4" W x 10' L. Temperature range -40° C to +100° C. Can be used on hot objects for an emergency repair on radiator hoses, etc.

Item **615101** **50-405** Ship 1 lbs **Net \$25.99**

**TAYLOR MADE RUBBER SPREADER BOOTS**

- Made of soft, tough, White synthetic rubber
- Protects rigging connections
- Resistant to weather, sea, temperature extremes and hard use
- Fits quickly and easily over the stay and spreader end
- For dimensions see [www.defender.com](http://www.defender.com)

Item	Model	Size	Ship	Net/Pair
<b>613670</b>	<b>960025</b>	1/2" - 1-1/2"	1 lbs	<b>\$25.99</b>
<b>613671</b>	<b>960026</b>	1" - 2"	1 lbs	<b>29.99</b>
<b>613672</b>	<b>960027</b>	2" - 3"	1 lbs	<b>35.99</b>

**WHITECAP SPREADER BOOTS**

- Made of soft, UV resistant rubber for long lasting durability
- Protect your sails from tearing on the end of your spreaders

Item	Model	Size	Ship	Net/Pair
<b>601507</b>	<b>S-9202</b>	1/2" - 1-1/2"	1 lbs	<b>\$18.99</b>
<b>601506</b>	<b>S-9201</b>	1" - 2"	1 lbs	<b>19.99</b>
<b>601505</b>	<b>S-9200</b>	2" - 3"	1 lbs	<b>19.99</b>

**EDSON LEATHER SPREADER BOOT KIT**

Edson's custom-cut, hand-stitched leather spreader boots will protect your sails from costly tears and chafe, providing you peace of mind at sea and leaving more money in your pocket. Each kit includes two pre-punched Dove Gray leather spreader boot covers, heavy waxed polyester thread for lacing, hand-stitching needle and instructions.

Item	Model	Circumference	Diameter	Ship	Net/Pair
<b>614682</b>	<b>1401-1</b>	3-1/8"	1"	1 lbs	<b>\$64.99</b>
	<b>1401-2</b>	6-3/4"	2"	1 lbs	<b>80.99</b>
	<b>1401-3</b>	9-1/2"	3"	1 lbs	<b>93.99</b>

**SEA-DOG ALUMINUM FOLDING MAST STEP**

- The folding mast step is constructed of polished, clear anodized cast #356 T-6 aluminum
- Low profile, the step extends only 1-1/2" from mast when folded
- Usable tread is 1-5/16" W x 5" L
- Adjustable nylon screw eliminates rattling when step is folded
- Contoured to fit mast this step installs with four 1/4" FH fasteners or pop rivets (Not included)
- Sold individually

Item	Model	Ship	Net
<b>615020</b>	<b>328030-1</b>	1 lbs	<b>\$24.99</b>

**SEA-DOG STAMPED 304 STAINLESS FOLDING MAST STEP**

- Constructed of stamped 304 stainless with a tumbled and electro-polished finish, this folding mast step can be locked in a rattle-free, upright position when not in use
- The unique design features a sawtooth edged step, providing secure footing when working on the mast
- Can also be used in many other areas where an additional step is needed but available space is limited
- Usable tread is 1" W X 4-1/4" L. Overall length is 5-5/8"
- Installs with four #10 FH fasteners (Not included)

Item	Model	Ship	Net
<b>601848</b>	<b>328025-1</b>	1 lbs	<b>\$18.99</b>

**MAST STEP FOLDING MAST STEP**

- Nylon/Glass fiber with a safe working load of 140 kg (310 lbs)
- Aerodynamic and snag-free profile
- No rattling in wind at anchor or mooring
- Please specify: White, Black or Gray

Item **602063** Ship 1 lbs **Net \$23.99**





# Hawk Marine Apparent Wind Indicators

Imported in North America by  
**SCHAEFER MARINE**

These are distributed in North America by Schaefer Marine and have the following features:

- Lightweight balanced nylon arm and a smooth V jewel bearing surface which gives instant response to shifts and gusts with minimal inertia
- Adjustable reference arms made from glass-filled nylon for ultimate rigidity and UV protection
- Support rod made from high grade 5 mm aluminum which can be bent to shape or easily straightened in case of damage
- Sturdy construction and materials
- Vane can be easily removed
- Mount included

## HAWK

- For dinghies, day sailors, sport boats and cruisers up to 27'
- Mount either vertically or horizontally



Item	Model	Vane Arm Length x Height	Boats	Ship	Net
602315	H001F00	10.63" x 11.02"	Up to 27'	1 lbs	\$31.99

## GREAT HAWK

- For cruising and racing yachts up to 65'
- Mount vertically or horizontally or can be bolted down to any pre-drilled 8 mm hole using the supplied adaptor, nut and bolt



Item	Model	Vane Arm Length x Height	Boats	Ship	Net
602316	H002F00	14.96" x 11.42"	27'-65'	1 lbs	\$47.99

## LITTLE HAWK MK1

- Mast top mounting; small and sturdy
- Accurate wind direction reading
- Minimal weight and drag
- Bearing: Aluminum pin



Item	Model	Vane Arm Length x Height	Boats	Ship	Net
602317	H003F00	6.50" x 11.02"	Optimists and other small dinghies up to 19'	1 lbs	\$18.99

## LITTLE HAWK MK2

- Mounts securely to the front of the mast with the included adjustable mounting clamp
- Allows the skipper to reference wind direction without having to look up the mast
- All the benefits of Little Hawk MK1, but smaller
- Accurate wind direction reading with minimal weight and drag



Item	Model	Vane Arm Length x Height	Boats	Ship	Net
602318	H004F00	6.50" x 7.50"	Dinghies up to 19'	1 lbs	\$24.99

## CAT HAWK

- Mounts onto the front of the forestay bridle where it provides maximum upwind and downwind visibility
- Reference arms can be set up to judge either the best upwind or downwind angles
- Mount has a quick release clip for easy rigging and de-rigging
- Bearing: V Jewel



Item	Model	Vane Arm Length x Height	Boats	Ship	Net
602319	H005F00	9.84" x NA	Non-spinnaker catamarans up to 26'	1 lbs	\$43.99

## HAWK RACE

- Mounts securely to the front of the mast, allowing the skipper to reference wind direction without looking up the mast
- Easy to mount and remove
- Bearing: V Jewel



Item	Model	Vane Arm Length x Height	Boats	Ship	Net
602320	H006F00	10.63" x NA	Single handed racing dinghies	1 lbs	\$37.99

## LITTLE HAWK RACE

- Vane is cut to minimal length, greatly reducing drag
- Mounting system is lightweight, yet strong
- Mast clamp is secured to the mast with included self tapping screws
- Indicator can be easily removed from the base without tools



Item	Model	Vane Arm Length x Height	Boats	Ship	Net
602321	H007F00	6.5" x 5.51"	Racing dinghies up to 26'	1 lbs	\$22.99

# Davis Windex Wind Indicator

**DAVIS**

Designed to provide the helmsman with accurate information on apparent wind direction. Has a moving vane and two fixed reference tabs. These tabs are set at the proper angle to correspond to apparent wind direction for tacking. The light reflecting material on the vane and on the reference tabs reflects the beam of the Windex light (light available below). Windex 15" includes a bird proof spike.

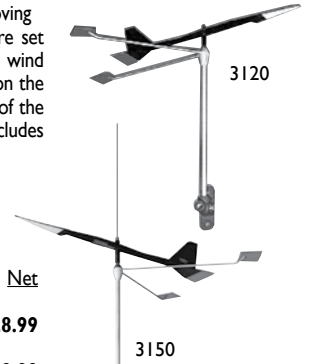

- Sapphire jewel suspension system
- Large fin/low inertia vane
- Easy-to-read, fully adjustable tacking tab system
- Wind tunnel tested to speeds of 80 knots

Item	Model	Description	Ship	Net
613828	3120	Windex 10.Sport		
		10" vane, 9-1/4" H	1 lbs	\$28.99
612009	3150	Windex 15		
		15" vane, 12-3/4" H	1 lbs	39.99

## WINDEX REPLACEMENT VANES

Item	Model	Description	Ship	Net
612018	3101	Windex 10 3120	1 lbs	\$18.99
612019	3151	Windex 15 3150	1 lbs	28.99

## DAVIS WINDEX LIGHT FOR 3120/3150/3100

Light up the reflector tabs and vane on your windex for easy viewing. Waterproof and non-corroding silver parts. Fits under Windex 15, Windex 10 or J-Base™ mounting socket. Mounts directly to the masthead fitting. 12 VDC, 120mA.

Item	Model	Ship	Net
612022	3200	1 lbs	\$25.99

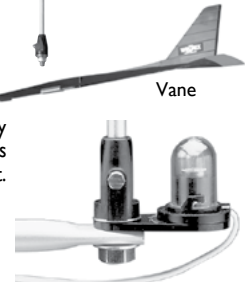

## DAVIS DELUXE UNIVERSAL MASTHEAD MOUNT

Extend your Windex 10.Sport, Windex 15, Telo-Vane and Spar-Fly away from masthead obstructions. The 13" arm comes with hardware to allow for side or top mounting and offset angles up to 20°. Mount on the back of the mast for easier viewing from the cockpit.

Item	Model	Ship	Net
612023	1705	1 lbs	\$25.99

Note: Can be used with the Windex light

## DAVIS WIND-TELS

Fits all shroud sizes up to 3/8". Port and starboard pair. One is Red, the other Green. Made of stainless steel and marine grade metal.

Item	Model	Ship	Net/Pr.
612032	1260	1 lbs	\$31.99

## DAVIS SPAR-FLY

Combines needle bearing balance, high impact plastic and marine grade metals for unsurpassed sensitivity and durability. Spoiler holes in the vane reduce lift and increase accuracy. Unaffected by angle of heel. Comes equipped with both a top mount fitting and quick-release side mount. Easily seen from the deck because of its V-shaped silhouette and bright Red color.

Item	Model	Ship	Net
612005	1310	1 lbs	\$23.99
613628	1311	Replacement vane	1 lbs 6.99

## DAVIS WINDEX AV ANTENNA MOUNT WIND VANE

Mount the Windex 15" onto a standard whip antenna less than 1/8". Reduces weight and windage aloft by combining two installations into one! Low-friction Teflon™ bearings, Windex 15" vane, reflective reference tabs, stainless steel arms and all components necessary for quick and easy installation. For power or sailboats. Antenna not included.

Item	Model	Ship	Net
612031	3160	1 lbs	\$34.99

## DAVIS AIR-FLOW TELS

- Lightweight, ripstop nylon
- No holes required
- Attach to sails with waterproof adhesive locator disks
- Includes 14 tels (1/2" x 10" long) and full instructions

Item	Model	Ship	Net
612004	950	1 lbs	\$6.99

## BOOMKICKER FASTALES™ TELLALES FOR SALES

- Package contains 7 Red and 7 Green double strand wool tell-tales with adhesive discs
- Resists hang-ups and sticking. flies straight, lifts great

Item	Model	Ship	Net
600889	FT1	1 lbs	\$5.99

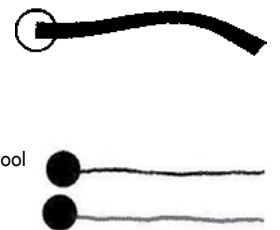

## Manual Bilge Pumps



**Whale Pumps Are Backed by a 5-YEAR MANUFACTURER'S WARRANTY!**

### Whale Manual Bilge Pumps

#### GUSHER 10 PUMP MK3- 17 GPM

This self-priming pump is virtually unchokeable. Available in two models: On-deck bulkhead mount or space saving thru-deck mount with removable handle. 1-1/2" hose.

Item	Model	Description	Ship	Net
500856	BP3708	On-deck / Bulkhead mount Gusher 10	6 lbs	\$259.99
500859	BP3740	Thru-deck / Bulkhead mount (Thru-deck) mounting plate (Required) not included	6 lbs	259.99
500860	DP3804	Thru-deck mounting plate with cover, anodized alloy	1 lbs	69.99
500861	DP8904	Thru-deck mounting plate with cover, ABS	1 lbs	34.99
503655	AK3706	Gusher 10 Service Kit (Neoprene)	1 lbs	48.99
	AK3714	Gusher 10 Service Kit (Nitrile)	1 lbs	48.99
500858	AS4405	Gusher 10 spare handle	1 lbs	49.99

#### GUSHER TITAN PUMP- 28 GPM

Won't corrode; built of molded plastic, nitrite and neoprene rubbers. Self-priming with easy flow valves for fast pumping. 1-1/2" hose.

Item	Model	Description	Ship	Net
500862	BP4402	On-deck mount Titan	4 lbs	\$123.99
500863	BP4410	Thru-deck / Bulkhead mount Titan with deck plate	5 lbs	144.99
501218	AK4400	Titan spare parts kit neoprene	1 lbs	42.99

#### GUSHER 30- 31 GPM

Double-acting with twin diaphragms to ensure that if one is pierced, the other one keeps pumping. Aluminum casting is first anodized and then epoxy-coated brilliant White. 1-1/2" hose.

Item	Model	Description	Ship	Net
500864	BP3000	Deck mount	14 lbs	\$499.99
500865	BP3010	Bulkhead mount	14 lbs	499.99
500866	BP3020	Thru-deck mount with deck plate	16 lbs	549.99
500867	AK3051	Service Kit: contains diaphragms, valves and gasket	2 lbs	69.99

#### WHALE GUSHER URCHIN - 14.5 GPM

Stepped ports; suitable for 1" and 1-1/2" hose with special nipple. Size: 5-1/2"x 6"x10".

Item	Model	Description	Ship	Net
500884	BP9005	Bulkhead/Fixed handle	2 lbs	\$64.99
500885	BP9021	On-deck/Removable handle	3 lbs	67.99
500886	BP9013	Thru-deck with removable handle	3 lbs	82.99
500887	AK9003	Urchin service kit (Neoprene)	1 lbs	26.99
503142	AK9011	Urchin service kit (Nitrile)	1 lbs	26.99

#### NOTE GUSHER 25 owners:

500888	AK3528	Gusher 25 spare parts kit	1 lbs	\$92.99
--------	--------	---------------------------	-------	---------

### Bosworth Guzzler Bilge Pumps



#### SERIES 400

• 10-1/4" long including end connections with (4) 1/4" dia. mounting holes on a 6-1/8" dia. bolt circle

Item	Model	Description	Hose Dia.	GPM	H x W x L	Ship	Net
500841	G-01001	Horizontal	1"	10	12" x 4-5/16" x 12-3/4"	3 lbs	\$59.99
500842	G-01011	Vertical	1"	10	13-5/16" x 4-5/16" x 10-1/4"	3 lbs	59.99
500843	G-02001	Pump with vertical handle; thru-deck mounting ring			13-7/8" x 9-1/2" x 10-1/4"	3 lbs	82.99

#### SERIES 500

Features larger end connections and an increased pumping capacity.

Item	Model	Description	Hose Dia.	GPM	H x W x L	Ship	Net
500846	G-08001	Horiz.	1-1/2"	12	12" x 4-5/16" x 13-1/8"	3 lbs	\$76.99
500847	G-08007	Vert.	1-1/2"	12	13-1/2" x 4-5/16" x 10-7/8"	3 lbs	76.99
500848	GH-M500D	Vert., thru-deck 1-1/2"	12	13-7/8" x 9-1/2" x 10-7/8"		3 lbs	99.99

#### GUZZLER THRU-DECK MOUNTING KITS - Includes deck plate, boot, spacer and thru-bolts

• Mounts the guzzler 400-V or 500-V below deck, sea or cockpit sole

Item	Model/Description	Ship	Net
500853	A-11001 For 400/500 series pumps above and older 400/500 models	1 lbs	\$42.99

#### GUZZLER SERVICE KITS

500854	GF-0400D-0.17 for series 400 pumps	1 lbs	\$17.49
500855	GH-0500D-1.17 for series 500 pumps	1 lbs	23.29

#### WHALE COMPAC 50 BILGE PUMP - 9.2 GPM

- Low profile underdeck mounting
- Rotating inlet and outlet nozzles for flexibility
- Quick and easy to fit
- Suitable for pumping diesel

Item	Model	Description	Ship	Net
501301	BP0350	4-3/4" deep; Port size: 1" with deck plate	3 lbs	\$104.99
501302	AK8035	Compac 50 service kit - contains daphragm, valves and fittings	1 lbs	49.99

#### WHALE SMARTBAIL MANUAL BILGE PUMP

#### 3 YEAR WARRANTY

- Sleek, integrated handle makes the pump instantly ready and easy to use
- No additional fittings needed
- Self-sealing; no messy sealants
- Ideal for confined spaces
- Quick connect ports swivels 360°

Using 1" Port:	45 Strokes/Min	70 Strokes/Min
10.17 gals/min	15.9 gals/min	17.9 gals/min
Using 1-1/2" Port:	11.5 gals/min	

Item	Model	Description	Ship	Net
500105	BP5012	(2) 1" and (2) 1-1/2" diameter ports included	3 lbs	\$87.99

#### WHALE MK5 MANUAL BILGE PUMP - Up to 17.5GPM

- Deck, bulkhead or thru-deck/bulkhead mount
- 6 different inlet and outlet positions
- Made of acetal and glass-reinforced polypropylene
- Up to 17.5 GPM at 70 strokes per minute; max lift 15'; for 1.5" hose

Item	Model	Hose Dia.	GPM	H x W x L	Ship	Net
500874	BP0510	1.5"	17.5	18-7/8" x 6-5/8" x 5-1/2"	4 lbs	\$144.99
500876	DP9906	Thru-Deck mount kit			2 lbs	47.99

#### MK5 WASTE PUMP

- This pump is the heart of the legendary Lavac head
- You can order these as replacements or spares for the Lavac head pumps

Item	Model	Description	Ship	Net
500877	BP0527	Bulkhead mount waste pump	4 lbs	\$134.99
500878	BP0535	Thru-deck/Bulkhead waste pump	4 lbs	154.99
500875	AK8050	Service kit for Mk5 pumps above	1 lbs	56.99

### Jabsco Amazon Manual Bilge Pump

- Flow direction can be changed 180° by interchanging inlet and outlet ports
- Optional push-fit inlet and outlet elbows swivel through 360° to increase flexibility of installation still further
- Unique safety feature allows operation from both inside and outside the cabin (With optional through deck kit)
- Quick release clamp ring gives fast access for blockage clearance
- Excellent solids handling ability for use with holding tanks

Item	Model	GPM	Hose Size	Ship	Net
502562	29270-0000	22	1-1/2"	4 lbs	\$99.99

### Plastimo Manual Bilge Pumps

- Fixed mount, hand-operated manual pump without by-pass
- Compact low-profile pump with telescoping handle

Item	Model	Flow Rate	Port Size	Ship	Net
502944	39539	10 GPM	1"	3 lbs	\$144.99
502945	39541	11 GPM	1-1/2"	3 lbs	144.99

### Beckson Handheld Pumps

#### THIRSTY MATE PUMPS - Flexible reinforced hose can be cut if needed.

Item	Model	Length	Hose Dia.	Strokes/Gal.	Hose Length	Ship	Net
500921	118PF	18"	1-1/4"	10	20"	1 lbs	\$28.99
500929	224PF	24"	1-1/2"	7	24"	1 lbs	31.99
500923	124PF	24"	1-3/4"	6	24"	2 lbs	39.99
500926	136PF	36"	1-3/4"	4	36"	2 lbs	43.99
500927	136PF6	36"	1-3/4"	4	72"	2 lbs	53.99

### Seachoice Handheld Pump

#### SEACHOICE HANDY BILGE PUMP

- Self-priming and easy to clean
- Made of non-corrosive plastic
- Includes 3 ft. flexible discharge hose

Item	Model	Length	Hose Dia.	GPM	Ship	Net
501597	19151	24"	1-1/2"	8	2 lbs	\$22.99



## Automatic Electric Bilge Pumps

### Whale SuperSub Automatic Bilge Pumps

- Low profile design for narrow bilges
- Outlet and mounting bracket rotate to suit installation
- Removable strainer designed to leave a minimum water level 10 mm (3/8") in bilge
- Built-in non-return valve and integrated bleed ball
- Solid state switch with no moving parts

Item	Model	GPH Flow	VDC	Amps	Hose Size	H x L	Ship	Net
503673	SS5212*	650	12	3.4	3/4" / 1"	3" x 8-3/8"	2 lbs	\$56.99
	SS1212*	1050	12	5	1" / 1-1/8"	3" x 9-1/2"	2 lbs	76.99
	SS1224*	1050	24	2.2	1" / 1-1/8"	3" x 9-1/2"	2 lbs	92.99

\*Stepped outlet port



### Whale Orca Auto 1300 Electric Bilge Pump

- Built-in automatic solid state sensor - separate bilge switch not required
- 1" - 1-1/8" stepped hose connection

Please specify: 12 or 24 Volt DC

Item	H x W x D	GPH Flow	VDC	Amps	Fuse	Ship	Net
503230	5.1" x 6.6" x 4.8"	1300	12	5	7A	3 lbs	\$104.99
	5.1" x 6.6" x 4.8"	1300	24	2.5	5A	3 lbs	109.99



Auto 1300

### Whale Remote Mount Bilge IC Pump Kit

Kit includes: bilge IC pump and IC strainer with integrated water level sensor

- Strainer IC automatically controls bilge IC when water is detected
- Barbed connections for either 19 mm (3/4") or 25 mm (1") hose sizes
- IC strainer features 12' control cable

Please specify: 12 or 24 Volt DC

Item	Model	GPH Flow	VDC	Amps	Hose Size	Ship	Net
501707	SI8284	300	12	7.5	3/4" - 1"	6 lbs	\$264.99
	SI8484	300	24	3.25	3/4" - 1"	6 lbs	299.99



Bilge IC Pump Kit

### Rule Electronic Automatic Bilge Pumps

- Automatically checks for water every 2-1/2 minutes
- Computerized operation based on impeller resistance
- When water is present, pump remains on until water is removed
- Uses minimal power in water sensing mode
- No float switch required

Automatic Pumps

Item	Model	GPH Flow	VDC	Amps	Hose Size	H x W	Ship	Net
503710	25SA	500	12	1.6	3/4"	4.1" x 2.9"	1 lbs	\$70.99
	25SA-24	500	24	1.0	3/4"	4.1" x 2.9"	1 lbs	79.99
	20SA	800	12	1.6	3/4"	4.7" x 2.9"	2 lbs	88.99
	27SA	1100	12	3.4	1 & 1-1/8"	4.7" x 2.9"	2 lbs	108.99
	27SA-24	1100	24	1.9	1 & 1-1/8"	4.7" x 2.9"	2 lbs	118.99
503713	53S	2000	12	8.4	1-1/8"	7-3/4" x 4-3/4"	5 lbs	221.99
	55S	3700	12	15.5	1-1/2"	8-1/4" x 4-7/8"	7 lbs	324.99
	56S	4000	12	15.5	2"	9-1/4" x 4-7/8"	7 lbs	335.99



3 Year Limited Warranty!

### Low Profile Automatic Bilge Pump

- This pump features two automated modes of operation (user choice):
  - **Electronic automatic mode:** The pump turns on every 2.5 minutes to check for water, and, if it's detected, the pump stays on until the water is gone
  - **High or low water sensing mode:** The pump starts when water reaches a 1.3" or 2" depending on user preference

Multiple ports included: 3/4", 1", 1-1/8" straight hose barb; 3/4" 90° hose barb

Item	Model	GPH Flow	VDC	Amps	Hose Size	L x W x H	Ship	Net
506444	LP900S	900	12	4	3/4", 1", 1-1/8"	9.35" x 2.3" x 2.3"	2 lbs	\$62.99



LP900S

### Rule-Mate Automatic Submersible Bilge Pump

- Pump turns on when water level reaches 2-3/4" and shuts off when water is removed
- Includes straight and 90° barb fittings (except the 1500 and 2000 which only includes the straight barbs)
- Solid state technology senses the dielectric constant of water only

Item	Model	GPH Flow	VDC	Amps	Hose Size	H x W	Ship	Net
503821	RM500B	500	12	1.8	3/4"	4-1/2" x 6"	1 lbs	\$59.99
	RM500B-24	500	24	1	3/4"	4-1/2" x 6"	1 lbs	59.99
	RM800B	800	12	3	3/4"	4-1/2" x 6"	1 lbs	81.99
	RM800B-24	800	24	1.6	3/4"	4-1/2" x 6"	1 lbs	83.99
	RM1100B	1100	12	3.8	1-1/8"	4-1/2" x 5"	2 lbs	104.99
	RM1100B-24	1100	24	2.1	1-1/8"	4-1/2" x 5"	2 lbs	108.99
503712	RM1500A 12V	1500	12	4.8	1" and 1-1/8"	6"H x 4.3"	5 lbs	173.99
	RM2000A 12V	2000	12	12	1" and 1-1/8"	6"H x 4.3"	5 lbs	221.99
	RM2000A-24 24V	2000	24	4	1" and 1-1/8"	6"H x 4.3"	5 lbs	227.99

\*Straight hose barbs included



3 Year Limited Warranty!

### Attwood Sahara Automatic Bilge Pumps

Features integrated strainer and float switch

Item	Model	GPH Flow	VDC	Amps	Hose Size	H x W x L	Ship	Net
503672	4505-7	500	12	1.5	3/4"	4" x 3-1/4" x 5-1/2"	1 lbs	\$49.99
	4507-7	750	12	2.8	3/4"	4" x 3-1/4" x 5-1/2"	1 lbs	67.99
	4511-7	1100	12	4	1-1/8"	4" x 3-1/4" x 5-1/2"	2 lbs	88.99



3 Year Limited Warranty!

### Johnson Ultima Bilge™ Automatic Pump

- Integration of the patented Ultima "field effect" sensing technology
- Includes both straight and 90° ports
- Features removable check valve

Item	Model	GPH Flow	VDC	Amps	Hose Size	Ship	Net
503670	32-47258-003	600	12	2.5	3/4"	2 lbs	\$46.73
	32-47259-003	800	12	3	3/4"	2 lbs	63.99
	32-47260-003	1000	12	3.2	3/4"	2 lbs	78.99
	32-47261-002*	1250	12	3	1-1/4" & 1-1/8"	2 lbs	94.99

\*This model only comes with straight fitting





Rule Submersible Bilge Pumps

3 Year Warranty!



- New design and improved performance for higher flow
- Hidden air vents prevent airlocking
- True electromagnetic suppression (EMC)
- Built-in thermal cell protects the pump and vessel



5 Year Warranty!



- Compact and efficient
- Vibrationless
- Water cooled
- Not self-priming
- Maintenance free
- Silent running
- Ignition protected
- Anti-airlock feature
- No burn-out when run dry
- Exclusive Rule moisture tight Teflon™ seal
- Non-automatic (requires float switch or manual switch)

Item	Model	GPH Flow	DC VDC	Amps	Hose Size	H x W	Ship	Net
<b>RULE LOPRO SUBMERSIBLE BILGE PUMPS - NON-AUTOMATIC</b>								
506443	LP900D	900	12	4	3/4", 1", 1-1/8"	2-1/4" x 2-3/10"	2 lbs	\$54.99
<b>RULE NEXT GENERATION SUBMERSIBLE BILGE PUMPS - NON-AUTOMATIC</b>								
503711	24DA	360	12	2.1	3/4"	3.9" x 2.9"	1 lbs	22.99
	25DA	500	12	1.6	3/4"	3.9" x 2.9"	1 lbs	29.99
	25DA-24	500	24	0.8	3/4"	3.9" x 2.9"	1 lbs	33.99
	20DA	800	12	3.4	3/4"	4.4" x 2.9"	2 lbs	44.99
	20DA-24	800	24	1.7	3/4"	4.4" x 2.9"	1 lbs	49.99
	27DA	1100	12	3.7	1" & 1-1/8"	4.4" x 2.9"	2 lbs	51.99
	27DA-24	1100	24	1.9	1" & 1-1/8"	4.4" x 2.9"	2 lbs	57.99
<b>RULE SUBMERSIBLE BILGE PUMP - REPLACEMENT PUMP FOR RULE 98A SHOWER SUMP</b>								
506492	20R	800	12	2.8	3/4"	3-3/4" x 2-3/8"	2 lbs	\$47.99
<b>RULE SQUARE SUBMERSIBLE BILGE PUMPS - NON-AUTOMATIC</b>								
503714	20F	800	12	2.8	3/4"	4" x 2-7/8"	1 lbs	\$41.99
	20A	1000	12	2.9	1-1/8"	4" x 2-7/8"	1 lbs	45.99
<b>RULE HIGH CAPACITY SUBMERSIBLE BILGE PUMPS - NON-AUTOMATIC</b>								
503715	02	1500	12	4.8	1-1/8"	6" x 4-1/4"	4 lbs	\$84.99
	03	1500	24	2.3	1-1/8"	6" x 4-1/4"	4 lbs	108.99
	10	2000	12	8.4	1-1/8"	6" x 4-1/4"	4 lbs	109.99
	12	2000	24	4	1-1/8"	6" x 4-1/4"	4 lbs	139.99
	14A	3700	12	15.5	1-1/2"	7-1/4" x 4-7/8"	7 lbs	189.99
	16A	3700	24	6.9	1-1/2"	7-1/4" x 4-7/8"	7 lbs	233.99
	56D	4000	12	15.5	2"	7-3/4" x 4-7/8"	7 lbs	231.99
	56D-24	4000	24	6.9	2"	7-3/4" x 4-7/8"	7 lbs	247.99
<b>RULE GOLD SERIES HIGH CAPACITY SUBMERSIBLE BILGE PUMPS - NON-AUTOMATIC</b>								
503716	04*	1500	12	4.8	1-1/8"	6" x 4-1/4"	4 lbs	118.99
	09*	2000	12	8.4	1-1/8"	6" x 4-1/4"	4 lbs	153.99
	13A*	3700	12	15.5	1-1/2"	7-1/4" x 4-7/8"	6 lbs	262.99

\* Gold Series Pumps carry a 5 year warranty

RULE 3-WAY LIGHTED BILGE PUMP SWITCHES - 12-32 VDC

- Controls any pump equipped with automatic float switch
- 3 positions: AUTOMATIC, OFF or MANUAL
- Switch has "fail safe" spring return to "off" from "manual" position

Item	Model	Type	Amps	VDC	Size	Ship	Net
506493	43	Rocker	20	12	2-3/8"H x 2-7/8"W	1 lbs	\$32.99
	44	Rocker	10	24	2-3/8"H x 2-7/8"W	1 lbs	41.99
501497	41	Toggle	20	12	2"H x 3-1/4"W	1 lbs	37.99
	42	Toggle	10	24/32	2"H x 3-1/4"W	1 lbs	34.99

RULE FLOAT SWITCHES

Item	Model	Description	Amps	L x W x H	Ship	Net
506495	35A	w/o fuse	14	5" x 1-3/4" x 2-5/8"	1 lbs	34.99
	35FA	w/ fuse holder	14	5" x 1-3/4" x 2-5/8"	1 lbs	39.99
500055	40A	R-A-M Plus w/o fuse	20	5-1/4" x 2-1/2" x 2-7/8"	1 lbs	46.99
<b>SuperSwitch Float Switch-Designed with larger float for increased buoyancy</b>						
506496	37A	w/o fuse	20	5" x 2-1/8" x 2-5/8"	1 lbs	\$48.99
	37FA	w/ fuse holder	20	5" x 2-1/8" x 2-5/8"	1 lbs	56.99

RULE HIGH-WATER BILGE ALARM

- Float switch and dash alarm, audible to 85 dB and visible, for constant monitoring
- Use No. 35 A float switches to add compartments
- In-Dash Gauge Cut-Out: 2-1/8" dia.

500054	33ALA	20	12	1/4" x 5" x 2-1/64"	1 lbs	73.99
--------	-------	----	----	---------------------	-------	-------

Jabco Diaphragm Bilge Pumps

- Self-priming diaphragm pumps
- Can run dry for extended periods without damage
- Vibration/shock mounting pads
- Permanently lubricated ball bearings on shaft and connecting rod
- Intake hose can be routed to the lowest point of the bilge regardless of space limitations
- USCG Approved
- Includes Pumpgard™ pre-filter

Item	Model	GPH Flow	VDC	Amps	Hose Size	H x W x L	Ship	Net
502336	37202-2012	180	12	8	3/4"	5-3/4" x 5-1/4" x 7-1/2"	5 lbs	\$272.99
500320	37202-0000	270	12	10	3/4"	6" x 4-1/8" x 7-5/8"	6 lbs	210.99
500723	36960-2000	240	12	6	3/4"	7.31" x 7.5" x 6.31"	7 lbs	337.99
500724	36680-2000	330	12	10	3/4"	8-1/2" x 6-1/2" x 7-5/8"	9 lbs	419.99
503479	36600-0000	480	12	15	3/4"	8-1/4" x 7" x 5-1/4"	9 lbs	449.99
	36600-0010	480	24	8	3/4"	8-1/4" x 7" x 5-1/4"	11 lbs	479.99

SERVICE KITS FOR DIAPHRAGM PUMPS

Item	Model	For Pump Model	Ship	Net
506421	50095-1000	37202 Series	1 lbs	\$99.99
503001	43990-0063	36960-2000	1 lbs	110.99
503002	43990-0062	36680-2000	1 lbs	120.99
503003	30124-0000	36600-0000	1 lbs	124.99
503004	30101-0000	34600-0000	1 lbs	134.99

❖ For more detailed product specifications and our complete selection visit [www.defender.com](http://www.defender.com) or call 800-628-8225. ❖



## Electric Bilge Pumps & Accessories

### Johnson PUMP L-Series HD Submersible Bilge Pumps

- Liquid cooled pumps with double bearings and mechanical seal (L2200) or compression lip seal (L1600)
- Convenient universal mounting snaps into mounting bases of other popular 1600 or 2200 GPH pumps

Item	Model	GPH Flow	VDC	Amps	Hose Size	Dia x H	Ship	Starting at
503675	1600	1600	12 or 24	7/3.5	1-1/8" & 1-1/4"	4.25" x 5.86"	4 lbs	\$85.12
	2200	2200	12 or 24	7.5/4.5	1-1/8" & 1-1/4"	4.25" x 7"	6 lbs	115.37
	4000	4000	12 or 24	15/7.5	1-1/2" & 2"	4.8" x 8.5"	7 lbs	209.99

3 Year Warranty!

Johnson Pump



L4000



L1600



33703

### Johnson Low Boy Bilge Pump

- Perfect for vessels with bilge pumps mounted beneath inboard or I/O engines • Easy-to-install

Item	Model	GPH Flow	VDC	Amps	Hose Size	H x W x L	Ship	Net
503676	33703	750	12	3	3/4"	2.82" x 3.2" x 5.75"	1 lbs	\$35.99
	33103	1250	12	3	1-1/8"	2.82" x 3.2" x 5.75"	1 lbs	46.61

### JOHNSON PUMPS ULTIMA SWITCH- Automatically activates any bilge pump

- Completely sealed and not affected by bilge oil or debris • 8 second delay prevents false starts

Item	Model	VDC	Max Amps	Description	Ship	Net
502961	36303	12/24	20	Detects liquid at set level	1 lbs	\$43.99

### JOHNSON BILGE PUMP CONTROL PANEL

- Integrated fuse holder, fuses and operating light • 3-Position rocker switch (Automatic/Off/Manual)

Item	Model	VDC	Max Amps	Dimensions	Ship	Starting at
503246	12 or 24	20	2.17" H x 2.9" W x 1.57" D	1 lbs	\$29.99	

### JOHNSON BILGE ALERT/HIGH WATER LEVEL ALARM PANEL WITH SENSOR

- LED warning light and 100 dB audible alarm • 3-Position rocker switch (Test/Off/Armed)

Item	Model	VDC	Max Amps	Panel Dimensions	Ship	Starting at
503247	12 or 24	20	2" H x 2.47" W	1 lbs	\$64.99	



Bilge Pump Control Panel



Bilge Alarm

36303

### Whale SuperSub 500 Bilge Pump

- Submersible low-profile pump designed for narrow or awkward bilge spaces
- Low-profile strainer ensures efficient operation with very low power consumption
- Easy to install, clean and maintain (snap-fit assembly) • Includes manual override capability

Item	Model	GPH Flow	VDC	Amps	Hose Size	H x L	Ship	Net
501181	SS5012	500	12	2.4	3/4"	2-1/8" x 7-3/16"	1 lbs	\$30.99

### WHALE AUTOMATIC BILGE SWITCH WITH ELECTRIC FIELD SENSOR TECHNOLOGY

- Automatically switches on when 2" of water is detected and off when water drops below 1/2"

Item	Model	VDC	Max Amps	Ship	Net
503235	BE9003	12 or 24	20	1 lbs	\$42.99
503236	BE9006	12 or 24	20	1 lbs	64.99

Note: The BE9006 features a 30 second shut-down delay for a more complete pump out.

### WHALE MECHANICAL FLOAT SWITCH- For Orca bilge pumps above and below

Item	Model	VDC	Max Amps	Mount	Ship	Net
503152	BE9002	12	15	Horizontal or vertical	1 lbs	\$17.99



SS5012

Ignition protected per ABYC and USCG standards



BE9003

BE9002

### Whale Orca Electric Bilge Pump

- Fits neatly in bilge areas with limited space • Easy access to motor cartridge and filter area

Item	Model	H x W x D	Open GPH		VDC	Amps	Hose Connection	Ship	Net
			Flow	Flow					
503678	BE0500	3.3" x 4" x 3.1"	500	500	12	1.5	3/4"	1 lbs	\$22.99
	BE0950	4.3" x 5.3" x 4.1"	950	950	12	3.5	1" - 1-1/8"	2 lbs	34.99
	BE1450	5.1" x 6.6" x 4.8"	1300	1300	12	5.0	1" - 1-1/8"	3 lbs	39.99
503679	BE2002	6.5" x 5.7" x 4.74"	2000	2000	12	10	1-1/8"	4 lbs	92.99



BE0500



BE2002

### SHURFLO Bilge Pumps

- Built for below waterline installations and water cooled motors for extended life
- Base capable of vertical bulkhead mounting

#### 380-1000 GPH BILGE PUMPS

- Standard with 3" tinned wire assembly • 12 VDC, 3/4" outlet (1-1/8" on 1000GPH)

Item	Model	Dimensions	GPH	Amps	Ship	Net
503701	355-020-10	4.2" x 3.75"	380	1.7	1 lbs	\$18.99
	355-010-10	4.2" x 3.75"	500	1.8	1 lbs	22.99
	355-110-10	4.2" x 3.75"	700	3.2	1 lbs	30.99
	355-100-10	4.2" x 3.75"	1000	3.2	1 lbs	34.99

#### 1500 & 2000 GPH BILGE PUMPS

- Standard with 6" tinned wire assembly • 12 VDC • 1-1/8" outlet

Item	Model	Dimensions	GPH	Amps	Ship	Net
503702	358-000-10	7.2" x 6.0"	1500	8	6 lbs	\$87.99
	358-010-10	7.2" x 6.0"	2000	10	6 lbs	105.99

### SHURFLO BILGE PUMP SWITCHES - Remote or direct mounting.

Item	Model	Volts	Max Amps	Description	Ship	Net
501678	359-111-30	12/24 VDC	12	Standard automatic	1 lbs	\$26.99
501679	359-111-40	12/24 VDC	12	Caged automatic	1 lbs	32.99

SHURFLO®



355-020-10

358-000-10



359-111-30



359-111-40

### Attwood Tsunami Bilge Pumps

- Replaceable, interchangeable cartridges • Barbed outlet

Item	Model	GPH Flow	VDC	Amps	Hose Size	H x W	Ship	Net	
503703	4606-7	500	12	1.8	3/4"	3.625" x 2.875"	1 lbs	\$20.99	
	4608-7	800	12	3	3/4"	4.375" x 3.25"	1 lbs	31.99	
	4612-7	1200	12	3.5	1-1/8"	4.375" x 3.25"	1 lbs	39.99	
503704	4620-6	Replacement motor cartridge for T500						1 lbs	18.99
	4622-6	Replacement motor cartridge for T800						1 lbs	26.99
	4624-6	Replacement motor cartridge for T1200						1 lbs	36.99

### ATTWOOD AUTOMATIC FLOAT SWITCH

Item	Model	VDC	Max Amps	Description	Ship	Net
500773	4201-7	12/24	12/6	Simple conversion, 36" wire	1 lbs	\$29.99



4606-7

attwood genuine ingenuity

3 Year Limited Warranty!



4201-7

## Water Pumps

# SHURFLO®

THE LATEST SERIES IN THE PENTAIR/SHURFLO LINE OF FRESH WATER PUMPS



4128-110-E04

## SHURFLO Aqua King™ II Fresh Water Pumps

Designed to be the next legendary group of pumps to exceed the expectations of Shurflo's customers, the 4128 and 4138 series pumps are constructed for smooth flow and no rapid cycling. The 4128 and 4138 series fresh water automatic demand pumps are quiet, thermally protected and can run dry without damage.

- Dry run capability
- 4 independent chambers
- Self-priming up to 6'
- Sealed switch and motor
- Built-in check valve
- Thermally protected
- Corrosion resistant electro coated motor
- Co-molded diaphragm
- Ignition protected, CE
- Adjustable switch

Item	Model	Description	VDC	GPM	Amps	PSI	Ship	Net
503693	4128-110-E04	Junior II	12	2	3.5	30	5 lbs	\$95.99
	4138-111-E65	Standard	12	3	6.5	55	5 lbs	112.99
	4138-131-E65	Standard	24	3	3.8	55	5 lbs	127.99

## SHURFLO Aqua King II Premium/Supreme Fresh Water Pump

Designed for boats with multiple fixtures, these pumps provide "just like home" shower pressure yet can operate at low flow conditions without cycling.

- Electro-coated seamless shell, O-ring sealed end bells and fully sealed wire entries on the motor shell
- Heavy duty motor withstands marine environment
- Can run dry without damage
- Ignition protected
- Pressure switch pumps
- Inlet strainer and 1/2" hose barb fittings included
- Thermally protected

Item	Model	Description	VDC	GPM	Amps	PSI	Ship	Net
503693	4148-153-E75	Premium	12	4.0	10	55	9 lbs	\$189.99
	4148-163-E75	Premium	24	4.0	5	55	9 lbs	215.99
	4158-153-E75	Supreme	12	5.0	13	55	9 lbs	280.99
	4158-163-E75	Supreme	24	5.0	7	55	9 lbs	307.99



3 Year Warranty!

## Jabco PAR-Max Water System Pump

Dual diaphragm operation. Thermal overload protection automatically stops motor should it overheat due to overload and has auto re-start feature. Diaphragm design allows dry running. 12 Volt DC.

Item	Model	Amps	GPM	Hose	Fuse Amp	H" x W" x L"	Ship	Net
502516	42631-2900 Manual	1.9	1.1	3/8"	4	2.3 x 3.5 x 6.4	2 lbs	\$79.99
502515	42630-2900 Auto	1.9	1.1	3/8"	4	2.3 x 3.5 x 6.4	2 lbs	79.99
506518	Specify 12V or 24V	2.9	1/2"			4.75 x 4.24 x 9.00	4 lbs starting at	99.99
	Specify 12V or 24V	3.5	1/2"			4.75 x 4.24 x 9.00	7 lbs starting at	142.99



42631-2900



31395-0092

## Jabco Par-Max Plus Series Water Pressure Pump

Provides high pressure capability, exceptional flow and consistent water pressure to handle the demand of multiple outlets. All Par-Max Plus models include soft rubber mounts and quick connect fittings for ease of installation. The patented Par-Max Plus co-injected molded diaphragm and larger heavy duty motor brushes significantly extend pump life.

Item	Model	Amps	GPM	Hose	Fuse Size	PSI	VDC	Ship	Net
506463	42630-2992-P	3.5	1	3/8"		35	12	2 lbs	\$74.99
	42630-2994-P	1.5	1	3/8"		35	24	2 lbs	86.99
506517	82400-0092	15	4	1/2"	20	60	12	9 lbs	134.99
	82400-0094	6	4	1/2"	15	60	24	9 lbs	157.99
	82500-0092	15	5	1/2"	20	60	12	9 lbs	164.99
	82500-0094	7.5	5	1/2"	15	60	24	9 lbs	181.99
	82600-0092	17	6	1/2"	20	60	12	9 lbs	179.99
	82600-0094	8.5	6	1/2"	15	60	24	9 lbs	204.99



82400

42630-2992-P

## Jabco Vflo Water Pressure Pump

Vflo goes beyond basic functionality to provide a quieter experience. The key addition is an electronic control system that operates the pump motor at variable speeds. This enables motor speed at start up and shut off to be ramped and gradual, meaning no water hammer and shock to your pipes or ears. Motor speed also matches water demand in real time. As additional faucets are turned on and more flow is needed, the motor speeds up. As they are turned off, demand falls and motor speed decreases. The result – motor speed is optimized to reduce power consumption and noise generation. NOTE: Do not install Vflo with an accumulator tank. Vflo was designed to operate independently and will not function properly if paired with an accumulator tank. Please specify voltage.

Item	Model	Amps	GPM	Hose	Fuse Size	PSI	VDC	Ship	Net
502620	42755-0092	12	5	1/2", 3/4"	15	40	12	9 lbs	\$289.99
	42755-0094	6	5	1/2", 3/4"	10	40	24	9 lbs	318.99



## Jabco PAR Automatic Water Pressure Pumps

- Dependable, self-priming
- Pulsation dampeners built in
- Nos. 36950, 36900, 36800 all maintain 20/40 PSI pressure and are shock mounted on large rubber pads
- Diaphragm type
- 12 Volt DC (other voltages available by special order)

Item	Model	Amps	Fuse Size	GPM	Hose	H" x W" x L"	Ship	Net
500736	36950-2000	6	8	3	1/2-5/8"	8-1/2 x 7-1/2 x 5-3/4	9 lbs	\$435.99
500737	36800-1000	6	8	3.3	1/2-5/8"	8-3/8 x 6-1/2 x 9-7/8	10 lbs	505.99
500738	36900-1000	7.5	15	4.2	1/2-5/8"	10-1/8 x 6-1/2 x 9-7/8	10 lbs	551.99

### Service Kits For Pumps Listed Above

500791	43990-0061				For model 36950-2000		1 lbs	112.99
500794	30122-0000				For model 36800-1000		1 lbs	107.99
500795	30121-0000				For model 36900-1000		1 lbs	134.99

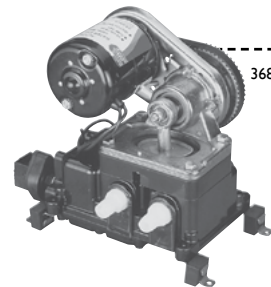

36800-1000

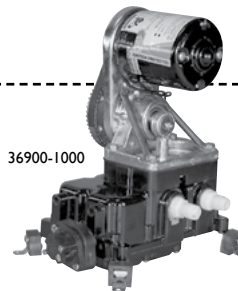

36900-1000

# FLOJET®



## Flojet 4405 Series Water System Pump with Internal Bypass

- Internal bypass feature eliminates pulsating water and pressure switch noise
- Services up to (5) outlets
- Pump can run dry without damage
- Quiet-running pump with soft, noise absorbing mounts
- Removable port-to-hose connectors
- Includes inlet strainer
- Manufactured from corrosion-resistant materials
- Thermally protected

Item	Model	Volts	Amps	Fuse Size	GPM	Hose	H" x W" x L"	Ship	Net
500664	04405143A	12	3.9	10	3.3	.5"	3.75 x 6.3 x 8.2	5 lbs	\$139.99



## Water Pumps

### Whale Watermaster Automatic Pressure Pump

- Runs dry without damage • Fully enclosed motor • Quiet automatic operation • For use with salt or fresh water
- Includes strainer to protect pump from debris, Whale Quick Connect 15 mm female connections, (2) 1/2" threaded connectors and (2) 1/2" barbed connectors

Item	Model	Flow	VDC	PSI	Amps	Number of Outlets	Ship	Net
503680	FW0814	2.0	12	30	4	1-2	5 lbs	\$109.99
	FW1214	3.0	12	30	6	3-4	5 lbs	109.99
	FW1215	3.0	12	45	6	3-4	5 lbs	109.99
	FW1225	3.0	24	45	3.5	3-4	5 lbs	109.99

IP65 Rated  
- no water  
ingress



### Whale Universal Freshwater Pressure Pump

- Includes inlet strainer • 4-diaphragm design ensures consistent flow
- Can run dry without damage • Self-priming up to 10'
- Can accommodate both 3/8" and 1/2" ports

Item	Model	Open GPM	VDC	PSI	Fuse	Outlets	Ship	Net
503677	UF0815	2.2	12	45	5 A	1-2	6 lbs	\$134.99
	UF1215	3.2	12	45	8 A	3-4	6 lbs	142.99



### Whale Pump Accumulator Kit

- Reduces noise and vibration by preventing pump cycling
- Can be fitted to new or existing systems
- 1/2" ports
- Maximum lift: 10'

Item	Model	GPM	VDC	PSI	Fuse	Outlets	Ship	Net
503458	UF2215	3.0	12	45	10 A	3-4	10 lbs	\$204.99
	UF2225	3.0	24	45	5 A	3-4	10 lbs	204.99

### Groco Paragon Junior PJR Water Pressure System

- Flow rate: 7.0 GPM, 40 PSI max., Port size: 3/4"
- Includes pump, pressure gauge and 3/4" inlet strainer

Item	Model	Voltage	Max. Draw	Fuse	Ship	Net
501822	PJR 12V	12 VDC	24 A	30 A	20 lbs	\$1424.99
	PJR 24V	24 VDC	12 A	20 A	20 lbs	1649.99
501823	PJR-A 12V	12 VDC	24 A	30 A	29 lbs	1910.99
	PJR-A 24V	24 VDC	12 A	20 A	29 lbs	1991.99



### Groco Paragon Senior PSR Water Pressure System

- Flow rate: 11.0 GPM, 50 PSI max., Port size: 1"
- Includes pump, pressure gauge and 1" inlet strainer

Item	Model	Voltage	Breaker	Ship	Net	Model	Voltage	Breaker	Ship	Net
506497	PSR 12V	12 VDC	50 A	40 lbs	\$3012.99	PSR 115VAC	115 VAC	10 A	40 lbs	\$2069.99
	PSR 24V	24 VDC	30 A	40 lbs	2932.99	PSR 230VAC	230 VAC	5 A	40 lbs	2139.99



### Johnson WPS Aqua Jet Water Pressure System Pump

- Unique, five chamber construction lowers pulsation and noise
- Pressure switch standard
- For small and medium size leisure and commercial boats
- Self-priming, easy low cost maintenance

Item	Model	Volts	GPM	Fuse	Port Size	Hose Size	Ship	Net
503674	10-13405-103	12	2.9	10 A	3/8"	1/2"	5 lbs	\$99.99
	10-13395-103	12	3.5	10 A	3/8"	1/2"	7 lbs	104.49
	10-13406-107	12	5.2	15 A	3/8"	1/2"	8 lbs	179.99



Quick-connect hose or threaded connectors available

## General Purpose/Baitwell Pumps

#### RULE TOURNAMENT "C" SERIES LIVELWELL/BAITWELL PUMP

For thru-hull applications. Angled 4" pickup tube.

Item	Model	GPH	Amps	Hose Size	Ship	Net
506519	401C	500	2.1	3/4"	2 lbs	\$54.99
	403C	800	2.8	3/4"	2 lbs	56.99
	405C	1100	3.3	1-1/8"	2 lbs	61.99

3 Year Warranty!

#### RULE TOURNAMENT "FC" SERIES LIVELWELL/BAITWELL PUMP

For thru-hull applications. Tapered 3/4" NPT pickup tube.

Item	Model	GPH	Amps	Hose Size	Ship	Net
506520	401FC	500	2.1	3/4"	2 lbs	\$53.99
	403FC	800	2.8	3/4"	2 lbs	56.99
	405FC	1100	3.3	1-1/8"	2 lbs	61.99

#### RULE TOURNAMENT "STC" SERIES LIVELWELL/BAITWELL PUMP

For thru-hull applications. Straight 4-3/4" pickup tube.

Item	Model	GPH	Amps	Hose Size	Ship	Net
506521	401STC	500	2.1	3/4"	2 lbs	\$54.99
	403STC	800	2.8	3/4"	2 lbs	56.99
	405STC	1100	3.3	1-1/8"	2 lbs	61.99

#### SHURFLO PIRANHA LIVELWELL PUMP

Anti-airlock clears trapped air in rough water.

Item	Model	GPH	Voltage	Inlet	Outlet	Ship	Net
503719	357-013-10	600	12	3/4"	3/4"	2 lbs	\$42.99
	357-113-10	800	12	3/4"	3/4"	2 lbs	48.99
	357-103-10	1100	12	3/4"	1-1/8"	2 lbs	52.99

#### SHURFLO BAIT SENTRY MAGNETIC DRIVE LIVELWELL PUMPS

- Magnetically driven impeller; debris will not damage motor
- Anti-airlock feature allows pump to clear trapped air in rough water or when boat is anchored.
- 3/4" Inlet OD

Item	Model	GPH	Outlet OD	Tank Size	Ship	Net
503720	1700-011-030	800	3/4"	40 Gal.	1 lbs	\$99.99
	1700-021-030	1100	1-1/8"	60 Gal.	3 lbs	109.99

#### WHALE GULPER GROUPEUR WASTE PUMPS

- Replace your macerator with the ultimate fishbox waste pump
- Diaphragm pump - no impeller to clog or burn
- Applications: fishbox, livewell and baitwell waste pump
- Port Size: 1" or 1-1/2"

Item	Model	Volts	GPM	Amps	Ship	Net
503387	BP4672/MK2	12	4.74	4	5 lbs	\$159.99
	BP4674/MK2	24	4.74	2	5 lbs	159.99
503537	BP4772/MK3	12	4.74	4	5 lbs	149.99
	BP4774/MK3	24	4.74	2	5 lbs	159.99

501278 Gulper Grouper/Gulper Grouper Mk 2 service kit Ship 1 lbs Net \$34.99

#### JABSCO WATER PUPPY PUMP

- Flexible impeller type pump is self-priming
- Can pass small solids without damage • Easily serviced
- Non-corrosive, heavy duty bronze head
- Ideal for bilge pumps, baitwells, washdowns, etc.
- 1" hose barb and 1/2" NPT with adapters for garden hose threads (GHT)\*
- No pressure switch • 3-1/4" H x 4-3/4" W x 6-3/8" L

Item	Model	Volts	GPM	Amps	Fuse	Hose Size	Ship	Net
502560	18660-0121	12	6.3	8	15 amp	*1/2" GHT	6 lbs	\$157.99
503005	90061-0006					Service kit for pump listed above	1 lbs	41.99

#### HEAVY DUTY

506395	18670-0123	12	8	11.5	20 amp	1/2" FPT, 1" hose barb	7 lbs	314.99
--------	------------	----	---	------	--------	------------------------	-------	--------

#### JABSCO PAR-MAX 4 LIVELWELL/BILGE PUMP

- Self-priming to 10' • No pressure switch
- Includes 36200-0 Pumpguard strainer
- Run-dry ability in a compact, low profile design
- Heavy duty motor has a special waterproof coatings
- Motors meet USCG requirements • 4-1/16" x 4-1/8" x 7-1/4"

Item	Model	Volts	GPM	Amps	Hose Size	Ship	Net	
500733	31705-0092	12	4.3	11	3/4"	7 lbs	\$187.99	
500790	18920-9053					Service kit for above	1 lbs	94.99

❖ For more detailed product specifications and our complete selection visit [www.defender.com](http://www.defender.com) or call 800-628-8225. ❖

# Washdown Pumps & Kits



## A. JABSCO PAR-MAX WASHDOWN PUMP KITS WITH HOSE

- Sealed switch and co-injected molded diaphragm
- Ergonomically designed spray nozzle provides powerful and accurate fire power
- Quick disconnect ports allow for ease of installation in hard to reach places
- Pumpgard Strainer prevents over 99% of the finest particles from clogging the pump
- IPX6 rated
- Includes: Pump, strainer, nozzle, snap fit port, 25' coiled hose

Item	Model	Amps	GPM	Ports	Fuse Size	PSI	Voltage	Ship	Net
506499	32901-0092	9	3	3/4"	15	50	12	8 lbs	\$133.99
	32900-0092	9	4	3/4"	15	60	12	9 lbs	134.99

## B. JABSCO HOTSHOT 4 WASHDOWN KIT

- Robust 5-chamber, patented co-injected molded diaphragm
- Larger, heavy-duty motor brushes significantly extend pump life
- Includes: Pump, strainer, nozzle, snap fit port

Item	Model	Amps	GPM	Ports	Fuse Size	PSI	Specify Voltage	Ship	Starting at
506500	82405	13/7	4	1/2"	20/10	70	12 or 24	9 lbs	\$141.99
	82505	16/8	5	1/2"	20/10	70	12 or 24	10 lbs	161.99
	82605	18/9	6	3/4"	20/10	70	12 or 24	10 lbs	174.99

## C. JOHNSON AQUA JET WASH DOWN PUMP KITS

- Five chamber diaphragm is designed to reduce noise and vibration
- Built-in pressure switch automatically turns pump on and off
- Includes pump, inlet strainer, spray nozzle, hose and illuminated panel switch
- Salt water tough 316 stainless steel hardware and bases

Item	Model	Volts	GPM	Amps	PSI	Port Size	Ship	Net
506504	WD 3.5	12	3.5	10.4	73	1/2" NPT / 3/4" Hose	11 lbs	\$161.99
	WD 5.2	12	5.2	20	73	1/2" NPT / 3/4" Hose	11 lbs	241.99

3 year warranty

## D. GROCO DECK WASH KIT

- Completely assembled and water tested
- Bronze pump, 10" L x 8" W x 3.88" H
- Mounted on an installation board with a pistol grip nozzle, check valves (low, high)
- Permanent magnet ball bearing motor has 316 stainless steel shaft

Item	Model	Specify Voltage	GPM (Max)	Amps (Max)	Ship	Starting at
506507	C-60	12 or 24	6.5	30	10 lbs	\$425.99
	C-80	12 or 24	7.5	30	12 lbs	679.99

1 year warranty

## E. SHURFLO BLASTER™ SERIES WASHDOWN PUMPS

- Sealed switch and motor
- 4 independent chambers
- Built-in check valve
- Includes Blaster, nozzle and fittings
- Corrosion resistant motor
- Self-priming up to 6'
- Dry run capability
- Ignition protected, CE
- Co-molded diaphragm
- Thermally protected
- Port Size: 1/2"

Blaster II	Item	Model	Volts	GPM	Amps	PSI	Ship	Net
	503442	4238-121-E07	12	3.5	7.5	45	6 lbs	\$130.99
1 Year warranty		4238-141-E07	24	3.5	7.5	45	6 lbs	143.99
ProBlaster II Deluxe	503705	4248-153-E09	12	4.0	10	60	9 lbs	185.99
2 Year warranty		4248-163-E09	24	4.0	5	60	9 lbs	212.99
ProBlaster II Ultimate		4258-153-E09	12	5.0	14	60	9 lbs	249.99
2 Year warranty		4258-163-E09	24	5.0	5	60	9 lbs	281.99

## F. SHURFLO PRO WASHDOWN KIT II

- All-in-one kit includes a PROBLASTER™ II Pump, fittings, a 25' coiled hose, blaster spray nozzle and a raw water strainer
- Self-priming, extremely rugged, delivers a high lift and can run dry without damage
- Sealed switch to prevent water damage
- Thermal and ignition protected

Item	Model	GPM	Amps	PSI	Ship	Net
503706	4348-153-E09	4.0	10	60	11 lbs	\$229.99
	4358-153-E09	5.0	14	60	12 lbs	307.99

Two Year warranty

## G. SHURFLO BLASTER II WASHDOWN PUMP KIT

- Unique over-molded single-piece diaphragm
- Corrosion resistant electro coated motor
- Kit Includes 25' Hose, blaster nozzle, strainer and fittings

Item	Model	Volts	GPM	Amps	PSI	Ship	Net
503530	4338-121-E07	12 VDC	3.5	7.5	45	9 lbs	\$169.99

Two Year warranty

## H. SHURFLO PRO BAITMASTER™ II HEAVY DUTY LIVEWELL/WASHDOWN PUMP

- Excellent for livewell or washdown applications
- Seamless motor shell and sealed switch protects the pump from splashed liquids
- Self-priming and can run dry without damage
- For tank size 35 gallons and under

Item	Model	Volts	GPM	Amps	PSI	Ship	Net
502396	4648-153-E07	12 VDC	4	8	45	9 lbs	\$265.99
	4648-163-E07	24 VDC	4	5	45	9 lbs	286.99

Two Year warranty

## Pump Accessories



### JABSCO ACCUMULATOR TANK

- Reduces water system pulsation and rapid on/off pump cycling
- Vertical mount

Item	Model	Description	PSI	Volume	Ship	Net
500718	30573-0000	1/2" fittings w/bladder	125	1 liter	2 lbs	\$83.99
500717	18810-0000	3/4" NPT (male) port w/bladder	100	2 gal.	6 lbs	204.99

### SHURFLO ACCESSORIES

Item	Model	Description	Ship	Net
500755	182-200	Accumulator tank; 30 PSI; 1/2" NPT; 24 oz.	2 lbs	\$63.99
500756	255-323	Twist-on water strainer; 1/2" male NPT; outlet is 1/2" NPSM	1 lbs	10.99
501675	255-315	Swivel water strainer inlet is male, outlet is 1/2" FPT	1 lbs	13.99
500758	340-001	In-line check valve; 1/2" barb	1 lbs	16.99

### RARITAN TRUDESIGN CONNECTOR WITH CHECK VALVE

- Used in-line to prevent water back-flow or siphoning
- Quick and easy identification of water flow direction

Item	Specify Inlet/Outlet Size	Ship	Starting at
503629	3/4", 1", 1-1/8", 1-1/4", 1-1/2" or 2"	1 lbs	\$23.99

### WHALE INLINE FRESH WATER BOOSTER PUMP

Designed to fit in-line above an electric or manual pump to boost flow rate.

- Flow Rate: 3.5 GPM (GPI392, GPI394), 4.16 GPM (GPI692)
- Port Size: 3/8" or 1/2" - suitable for both
- Nominal Voltage: 12 Volt DC (GPI392, GPI692), 24 Volt DC (GPI394)
- Max. Current Draw: 3.6A (GPI392), 3.8A (GPI692), 1.8A (GPI394)
- Recommended Fuse: 5A (GPI392, GPI692), 3A (GPI394)

Item	Model	Description	Ship	Net
503552	GPI392	3.5 GPM premium, 12 Volt DC	1 lbs	\$37.99
	GPI394	3.5 GPM premium, 24 Volt DC	1 lbs	37.99
	GPI692	4.16 GPM high flow, 12 Volt DC	1 lbs	32.99

### JABSCO PUMP GARD IN-LINE STRAINERS - 40 MESH / FINE

Keep accumulation out of pump and lines to eliminate the risk of damage and repairs.

Item	Model	Inlet	Outlet	Ship	Net
506513	46400-0012	Direct lug-in	1/2" 90°	1 lbs	\$21.99
	46400-0010	3/4"	Direct plug 90°	1 lbs	21.99
506473	46400-0000	3/4" hose barb	3/4" hose barb	1 lbs	20.99

### JABSCO PUMP GARD IN-LINE STRAINERS - 20 MESH / COARSE

Item	Model	Inlet	Outlet	Ship	Net
506472	46200-0000	3/4" hose barb	3/4" hose barb	1 lbs	\$22.99

### WATER WITCH MERCURY-FREE AUTOMATIC ELECTRONIC SWITCHES

Item	Model	Description	Max Amps	Ship	Net
500660	217	12 Volt DC, .006 Amps	10	1 lbs	\$52.99
					Starting at
502920	230	Specify 12 or 24 Volt DC, .006A	10/15	1 lbs	56.99
502734	101	Specify 12 or 24 Volt DC, .004A	15/10	1 lbs	37.99

### AQUALARM SMART BILGE MONITOR & ALARM

- Alerts to excessive pumping using any pump switch
- Red light turns on when pump runs; loud buzzer activates after two minutes of pumping;
- Green light indicates power
- 12 Volt DC
- Built in fuse holder

Item	Model	Description	Ship	Net
501531	20343	Pump alarm/monitor w/counter, 6-1/4" H x 4" W	1 lbs	\$124.99
501532	20346	Pump alarm, 2-5/8" W x 5-3/8" H x 2-1/8" D	1 lbs	\$72.99

### AQUALARM HEAVY DUTY MERCURY-FREE PUMP SWITCH

- Includes 5' of marine grade tinned wire
- Easy three wire installation
- Power: 12 Volt DC; Maximum draw: 30A
- Waterproof material: plastic and epoxy sealed

Item	Model	Dimensions	Ship	Net
550550	20090	1-3/4" x 4-1/2" diameter	1 lbs	\$45.99



ALL RARITAN TOILETS FEATURE A SLOW CLOSE LID

## RARITAN PH SUPERFLUSH MANUAL TOILET WITH SLOW CLOSE LID

- Updated base provides a cleaner installation
- Offers a direct bolt hole pattern like other competing manual toilets
- Superior double action piston pump takes fewer strokes per use
- Piston housing is 66% larger than the competitive units
- Dry flush option
  - Efficient LEVER handle
- Slow close seat and lid
  - Economical, trouble-free quiet operation
- Powerful flushing action
  - Reversible pump mounting
- Air vent reduces back pressure
- Double-action piston pump draws new flush water as it discharges wastewater

**Color:** White **Pump type:** Dual action **Seat height:** 13" (Compact) / 13.125" (Household) **Inlet size:** .75" **Outlet size:** 1.5" **Discharge:** 90° **Water consumption:** Approximately 1/2 gallon **Warranty:** 1 year

RINSE/FLUSH WATER: RAW/SEA-LAKE

### COMPACT STANDARD MARINE

Item	Model	Control	Ship	Net
D 503566	P101	Hand operated piston pump	49 lbs	\$299.99

### HOUSEHOLD STANDARD MARINE

Item	Model	Control	Ship	Net
D 503567	P102	Hand operated piston pump	46 lbs	\$314.99

Compact bowl size: 13" H x 17-3/4" W x 17-1/4" D  
Household bowl size: 13-1/8" H x 18-1/4" W x 20" D



## RARITAN PH POWERFLUSH TOILET WITH SLOW CLOSE SEAT/LID

- Easily converts from electric to manual flushing
- Rugged polymer construction
- PHII piston pump is 66% larger than competitive models
- Full size 1.5" joker valve
- Select 12 VDC or 24 VDC
- Can be installed above or below the waterline

**Color:** White **Pump type:** Dual action **Inlet size:** .75" **Outlet size:** 1.5" **Discharge:** 90° or optional straight **Water consumption:** Approximately 1/2 gallon **Warranty:** 1 year

RINSE/FLUSH WATER: RAW/SEA-LAKE

### COMPACT STANDARD MARINE

Item	Model	Control	Ship	Net
D 503730	P101E	Electric rocker switch/ Retractable handle	46 lbs	\$654.99

### HOUSEHOLD STANDARD MARINE

Item	Model	Control	Ship	Net
D 503731	P102E	Retractable handle	46 lbs	\$664.99

Compact bowl size: 14.25" H x 18" W x 20" D  
Household bowl size: 14.5" H x 18.25" W x 22.75" D



## RARITAN FRESH HEAD TOILET WITH SLOW CLOSE SEAT/LID

- First manual marine toilet to utilize pressurized fresh water which eliminates calcium deposits in discharge hose
- Footprint is a direct replacement for competitive models
- No thru hulls necessary when installed with a holding tank
- Low water use toilet
- With a diaphragm type pump and telescopic handle, flushing is extremely easy
- Vitreous china bowl, robust wooden seat and cover with baked enamel finish
- Owners choose how much water to use
- PHII toilets can be retrofitted by purchasing the retro-fit pump

**Color:** White **Inlet size:** .5" **Outlet size:** 1.5" **Water consumption:** 1 pint for liquid, approximately 1 gallon for solid

RINSE/FLUSH WATER: ON-BOARD PRESSURIZED FRESHWATER

### COMPACT STANDARD MARINE

Item	Model	Control	Ship	Net
502594	25M00	Flush control lever	46 lbs	\$399.99

### HOUSEHOLD STANDARD MARINE

Item	Model	Control	Ship	Net
D 502595	25H00	Flush control lever	46 lbs	\$434.99

Compact bowl size: 13" H x 17-3/4" W x 17-1/4" D  
Household bowl size: 13-1/8" H x 18-1/4" W x 20" D



## RARITAN FRESH HEAD RETROFIT KIT

- Converts toilet water supply from raw water to pressurized fresh water
- Conversion applications: PHII, PH, PHC, CPII and CP model toilets
- Kit includes everything required for water source changeover
- Greatly reduces chronic head odors
- Prevents calcium deposit buildup in discharge hose
- Built-in freshwater back-flow prevention and vacuum break
- Lock-out feature stops back-flow coming in through the discharge when not in use

### FRESH WATER CONVERSION KIT

Item	Model	Ship	Net
503404	2500RFK	5 lbs	\$209.99



## RARITAN MANUAL HEAD ACCESSORIES

Item	Model	Description	Ship	Net
502337	PHIIPUMP	PHII pump assembly with discharge fitting, joker and flapper valves	4 lbs	\$224.99
500285	PHECKII12	Electric conversion kit w/ HD push button switch	8 lbs	\$44.99
500290	PHRKiIC	PH & PHEII overhaul kit cart. Seal 6/92 to present	1 lbs	\$4.99
500291	PHRKiI	PHII & PHEII overhaul kit U-cup Seal 11/1981 - 6/1992	1 lbs	\$7.99
501192	I208W	Retractable toilet handle for PHII, PHHBII and PHC toilets	1 lbs	\$2.99

Item	Model	Description	Ship	Net
500292	PHRK	PH & PHE overhaul kit I/1968 - 11/1981	1 lbs	\$59.99
503565	I238SC	Slow close toilet seat - Marine compact	5 lbs	\$47.99
	I245SC	Slow close toilet seat - Household	7 lbs	\$47.99
503404	2500RFK	Fresh head retrofit kit, includes everything required for water source changeover	5 lbs	\$209.99

## JABSCO TWIST 'N' LOCK MANUAL TOILET

- For extra safety and peace of mind the intuitive, simple to use, Twist 'n' Lock action handle guards against syphonic flooding and waste backflow
- Powerful, self-priming, double-acting piston pump for above/below waterline installation
- Easily adapts for right or left-handed installs
- Spring assisted top valve closure for easier priming
- Powerful swirl action for efficient flushing
- Full-sized external seal housing allows quick, clean seal replacement and instant access to pump cylinder

**Inlet Size:** .75" **Outlet Size:** 1.5" **Discharge shape:** Multi-angle **Warranty:** 1 year

RINSE/FLUSH WATER: RAW/SEA-LAKE

### COMPACT STANDARD MARINE

Item	Model	Control	Ship	Net
D 506483	29090-5000	Flush control lever	43 lbs	\$197.99

### HOUSEHOLD STANDARD MARINE WITH SOFT CLOSE LID

Item	Model	Control	Ship	Net
D 506485	29120-5100	Flush control lever	43 lbs	\$226.99

Compact bowl size: 13.19" H x 16.73" D x 17.72" W  
Household bowl size: 13.58" H x 19.29" D x 18.31" W



## JABSO MANUAL HEAD ACCESSORIES

Item	Model	Description	Ship	Net
501200	29040-3000	29 Series manual replacement toilet pump	2 lbs	\$95.99
500242	29045-2000	29 Series manual toilet service kit, 1997-2007	1 lbs	\$7.99

Item	Model	Description	Ship	Net
502391	29045-0000	29 Series manual toilet service kit, pre 1997	1 lbs	\$83.99
506391	29045-3000	Service kit for models 29090-3000 and 29120-3000	1 lbs	\$80.99



# Manual Marine Heads



### GROCO MODEL K-H MANUAL

- Top quality marine toilet features an all bronze pump with porcelain bowl
- 4 GPM with 3" piston pump and Teflon® rings for clog-free service
- Automatically shuts water intake off when foot pedal is released
- No valves to close or handwheels to turn

**Color:** White **Seat height:** 16.78" **Bowl size:** Household  
**Inlet size:** .75" or 1" **Outlet size:** 1.5" **Discharge:** 90°  
**Warranty:** 1 year

**RINSE/FLUSH WATER:** RAW/SEA-LAKE

### HOUSEHOLD STANDARD MARINE

Item	Model	Control	Ship	Net
500340	K-H	Flush control lever	52 lbs	\$1017.99

### SERVICE KIT

501207	K REGULAR	Service kit	1 lbs	99.99
--------	-----------	-------------	-------	-------

**Dimensions (household):** 16.78" H x 15.68" W x 18.76" D

### GROCO COMPACT MANUAL HF SERIES

- Compact, light unit for tight quarters
- Low profile vitreous china bowl fits in an area only 16.84" deep
- Easy to pump; water-saver design
- Strong bronze base
- Curved tailpiece (straight tailpiece available by Special Order)
- Some assembly required (takes approximately 10 minutes)

**Color:** White **Seat height:** 12.44"  
**Bowl size:** Compact **Inlet size:** .75" **Outlet size:** 1.5"  
**Discharge:** 90° **Warranty:** 1 year

**RINSE/FLUSH WATER:** RAW/SEA-LAKE

### COMPACT STANDARD MARINE

Item	Model	Control	Ship	Net
500338	100-0001-00	Flush Control Lever	27 lbs	\$356.99

### ACCESSORIES FOR HF SERIES

500339	HF MASTER	Master service kit (recommended)	1 lbs	111.99
502325	HF PUMP ASSY	HF pump assembly	3 lbs	252.99

**Dimensions (compact):** 12.44" H x 16.84" D x 17.29" W



### DOMETIC (FORMERLY SEALAND) 711-M28 GRAVITY-FLUSH TOILET SYSTEM

- Permanent mount, combo manual toilet and holding tank
- Uses vessel water supply
- Flushing action and water level controlled by pedal
- MSD holding tank has 9 gallon capacity
- 1-1/2" outlet to pump out or seacock

**Seat height:** 20.125" **Bowl size:** Marine **Color:** Bone **Inlet size:** .5"  
**Outlet size:** 1.5" **Discharge:** Straight **Water consumption:** 1 Quart  
**Warranty:** 1 year

**RINSE/FLUSH WATER:** ON-BOARD PRESSURIZED FRESHWATER

### COMPACT STANDARD MARINE

Item	Model	Control	Ship	Net
500258	312371103	Flush pedal lever	53 lbs	\$524.99

**Dimensions (compact):** 20.625" H x 18.875" W x 19.25" D



### JOHNSON AQUA T MANUAL MARINE TOILET

- Corrosion-resistant parts throughout
- Quiet, robust and easy to clean
- Gives you years of trouble free operation
- Manual version incorporates an ergonomically designed, hand powered piston pump that can be mounted for either left-hand or right-hand use

**Toilet bowl:** 100% vitreous china **Toilet seat:** Wood with baked enamel finish **Water consumption:** .53 gallons per flush **Outlet ports:** 38 mm (1-1/2"), 25 mm (1") **Inlet ports:** 19 mm (3/4")

*When spare parts such as a new seat or valve are needed, you'll find Johnson Pump's global network of distributors at your service. Quiet, hygienic and reliable, the Johnson Pump AquaT™ marine toilet is perfect for almost any marine head.*

**RINSE/FLUSH WATER:** RAW/SEA-LAKE

### COMPACT STANDARD MARINE

Item	Model	Control	Ship	Net
503112	80-47229-01	Flush control lever	26 lbs	\$134.99

### HOUSEHOLD STANDARD MARINE

Item	Model	Control	Ship	Net
503113	80-47230-01	Flush control lever	30 lbs	174.99

**Dimensions (compact):** 13.58" H x 16.73" D x 17.72" W  
**Dimensions (household):** 13.37" H x 19.29" D x 18.50" W

# Portable Heads



### THETFORD 565E PORTA POTTI CURVE

- Power: (6) AA batteries (included)
- Fresh water: 4.0 gallons
- 3 year warranty
- High profile, sleek, modern and homelike design, comfortable seat height
- Battery-powered flush
- Waste tank: 5.5 gallons

Item	Model	H x W x D	Ship	Net
503729	565E	17-5/8" x 15-1/4" x 17-3/4"	14 lbs	\$172.99
501583	92415	Hold Down Bracket	2 lbs	25.99



### THETFORD PORTA-POTTI

- Refreshed, modern appearance with easy to clean seat and cover design.
- Redesigned valve handle, fill cap and pump
- Water in top tank, waste in bottom
- Built-in deodorant compartment
- Positive vane seal for odor control
- Lid Latch now standard
- Piston pump flush
- 3 year warranty
- Color: Parchment

Item	Model	Discharge	Hold Down				Ship	Net
			Down Kit	Fresh Gal.	Waste Gal.	Average Flushes		
503726	135*	Pour Spout	Yes	2.6	2.6	27	9 lbs	\$94.99
503727	335	Pour Spout	Yes	2.6	2.6	27	9 lbs	123.99
503202	550P	MSD	Yes	4.0	5.5	56	12 lbs	169.99
503728	365	Pour Spout	No	4.0	5.5	56	12 lbs	144.99
503240	92922	Hold Down Kit for F/320, 550P, Campa XTs and MT portable toilets					1 lbs	\$23.99

\* Includes an economy bellow style pump



### DOMETIC (FORMERLY SEALAND) SANIPOTTIE® 970 SERIES TOILETS

- Powerful flushing at the touch of a button
- No manual pumping or batteries, yet delivers a bowl-clearing flush
- An easy-view level indicator lets you know when to empty the tank
- 974 and 975 Series include mounting brackets

**Please specify color:** Tan or Gray

Item	Model	Gallons	H" x W" x D"	Ship	Net
501643	972	2.6 w/out brackets	12-1/2" x 13-1/8" x 15-1/4"	12 lbs	\$114.99
501644	974	2.6 with brackets	12-1/2" x 13-1/8" x 15-1/4"	13 lbs	129.99
501645	974MSD	2.6 with MSD fittings	12-1/2" x 13-1/8" x 15-1/4"	13 lbs	148.99
501646	975	5.0 with brackets	15-1/4" x 13-1/8" x 15-1/4"	13 lbs	154.99
501647	975MSD	5.0 with MSD fittings	15-1/4" x 13-1/8" x 15-1/4"	14 lbs	115.00



### DOMETIC (FORMERLY SEALAND) SANIPOTTIE 960 SERIES TOILETS

- Dual-tank portable toilet with water tank above, waste container below
- Odor-free seals; stainless steel hold-downs (Included on all models except 962)
- Pour-out portable or integral MSD for portable use or plumbing to pump out or seacock
- Color: Parchment

Item	Model	Gallons	H" x W" x D"	Ship	Net
503649	962	2.5 w/out brackets	12" x 14-1/2" x 16-1/2"	11 lbs	\$74.99
500251	964	2.5 with brackets	12" x 14-1/2" x 16-1/2"	11 lbs	109.99
500252	964MSD	2.5 with MSD fittings	12" x 14-1/2" x 16-1/2"	11 lbs	129.99
500254	965	5 with brackets	15-1/2" x 14-1/2" x 16-1/2"	13 lbs	134.99
500255	965MSD	5 with MSD fittings	15-1/2" x 14-1/2" x 16-1/2"	14 lbs	149.99

❖ For more detailed product specifications and our complete selection visit [www.defender.com](http://www.defender.com) or call 800-628-8225. ❖



## Marine Toilet Parts & Accessories

Item	Model	Description	Ship	Net
<b>RARITAN PARTS/KITS FOR MANUAL TOILETS</b>				
502331	C253	Joker valve - PHC/PHII/PI01/PI02	1 lbs	\$19.99
501197	I228CW	Flapper valve**	1 lbs	28.99
501335	I214W	Piston shaft seal assembly**	1 lbs	29.99
500290	PHRKiC	Overhaul kit**	1 lbs	64.99
500291	PHRKiI	Overhaul kit - PH/PHEII, 1981-6/1992	1 lbs	57.99
500280	CPRKiI	Overhaul kit - CPRKiI	1 lbs	79.99
755430	I212W	Piston rod with O-ring**	1 lbs	59.99
501080	I211-PL	Piston rod yoke**	1 lbs	26.99
501195	I200CW	PHII Housing assembly only**	2 lbs	64.99
502337	PHIIPUMP	Complete PHII pump assembly**	4 lbs	224.99
501192	I208W	Retractable handle**	1 lbs	22.99
503404	2500RFK	FreshHead retrofit kit**	5 lbs	209.99
501095	I248W	Toilet base - PHII/PHEII	2 lbs	44.99
501088	I222B	Straight discharge**	1 lbs	19.99
501259	I222AW	90° Discharge**	1 lbs	14.99

Item	Model	Description	Ship	Net
<b>RARITAN PARTS/KITS FOR ELECTRIC TOILETS/WASTE SYSTEMS</b>				
502331	C253	Joker valve - PHEII and CROWN	1 lbs	\$19.99
503299	C254	Joker valve w/cross slits**	1 lbs	19.99
503212	221135	Elegance and Atlantes joker valve	1 lbs	13.99
503213	MERK	Discharge pump repair kit (Elegance and Atlantes vortex vac)	1 lbs	38.99
502268	CDRK	Service kit - CROWN**	1 lbs	142.99
500310	CSRK	Service kit - CROWN**	1 lbs	134.99
503014	SEADISRK	Discharge repair kit - SeaEra	1 lbs	46.99
501191	I203BW	Inlet valve assembly - PH**	1 lbs	27.99
503013	DIAPUMPRK	Repair kit / Diaphragm intake pump**	1 lbs	54.99
503509	53100RK	Macerator pump repair kit - 53100-series	1 lbs	46.99
503510	53101RK	Macerator pump repair kit - 53101-series	1 lbs	49.99
503511	53120W	Macerator pump impeller kit - 53120W	1 lbs	34.99
503515	2210012 12 VDC	Replacement discharge pump assembly- Elegance toilet	6 lbs	274.99
	2210024 24 VDC		6 lbs	289.99
501211	CHI02MW	Intake pump - Crown heads (post 1988)	1 lbs	219.99
501337	I66012A	Replacement motor - SeaEra	5 lbs	124.99
503035	ESTDC	Dual control	1 lbs	146.99
500385	32-5000	Electrode pack for Lectra/San	1 lbs	394.99

Item	Model	Description	Ship	Net
<b>RARITAN SLOW CLOSE TOILET SEAT AND LID</b>				
503565*	I238SC	For marine compact model	5 lbs	\$47.99
	I245SC	For household model	7 lbs	47.99

\* Fits all Raritan toilets except Atlantes elongated models

\*\* Visit [defender.com](http://defender.com) for complete application information

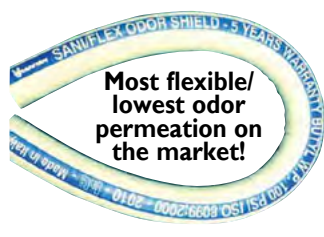

Item	Model	Description	Ship	Net
<b>RARITAN SANI/FLEX SANITATION HOSE</b>				
503529	SFHI	Sani/Flex sanitation hose 1"	1 lbs	\$9.99/ft.
503529	SFH	Sani/Flex sanitation hose 1-1/2"	1 lbs	10.49/ft.
<b>GROCO PARTS/KITS FOR TOILETS</b>				
500221	H-27-A	Joker valve for HF & K series	1 lbs	\$7.99
501568	HT-84-A	Spring assembly for foot pedal - K/EB	1 lbs	8.99
501207	K REGULAR	K regular service kit	1 lbs	102.99
501566	HF-20	Cam assembly for HF heads	1 lbs	44.99
501441	HF-1	HF intake gasket	1 lbs	24.99
501562	HF REGULAR	Regular service kit	1 lbs	74.99
500339	HF MASTER	HF master service kit	1 lbs	111.99
500222	HF-C	HF pump cylinder	1 lbs	60.99
502325	HF PUMP ASSY	HF pump assembly	3 lbs	252.99
501205	EB MASTER	EB master service kit	1 lbs	193.99
501663	HT-26-A	Bowl gasket - K/EB	1 lbs	11.99
500208	500-D-0	Toilet seat, White, K-series 1994-newer	7 lbs	63.99

Item	Model	Description	Ship	Net
<b>JABSCO PARTS/KITS FOR MANUAL TOILETS</b>				
500656	29092-1000	Joker valve kit	1 lbs	\$17.99
506374	29043-0000	Base gasket assembly - 29090/29120	1 lbs	28.99
506362	29042-0000	Top valve gasket - 29090/29120	1 lbs	20.99
500242	29045-2000	Major service kit, 1998 - 2007	1 lbs	77.99
506391	29045-3000	Major service kit, 2008 - Present	1 lbs	80.99
502391	29045-0000	Major Service kit, Pre - 1997	1 lbs	83.99
500162	29051-2000	Twist 'n' Lock pump cylinder	2 lbs	54.99
501200	29040-3000	Twist 'n' Lock complete pump assembly	2 lbs	95.99
502563	29200-0120	Electric conversion kit, 12 VDC	8 lbs	373.99
500169	29101-0000	Service kit - 29200	1 lbs	78.99
501312	37255-0092	Quiet flush conversion kit	13 lbs	567.99
502656	37010-0092	Electric conversion kit, 12 VDC	7 lbs	393.99

Item	Model	Description	Ship	Net
<b>JABSCO PARTS/KITS FOR ELECTRIC TOILETS</b>				
500656	29092-1000	Joker valve kit - Lite flush/Deluxe flush	1 lbs	\$17.99
500171	44106-1000	Joker valve kit - 37010/Quiet flush/Designer	1 lbs	12.99
500250	37040-0000	Service kit - 37010	1 lbs	58.99
506390	37006-0000	Centrifugal impeller - Quiet flush/37010	1 lbs	28.99
502399	6303-0003-P	Flexible impeller - 37010	1 lbs	28.99
506437	37004-1000	Base assembly - 37010	2 lbs	122.99
502462	44107-1000	1" Discharge port - 37010	1 lbs	12.99
500319	37014-0000	Macerator housing - Quiet flush/37010	1 lbs	31.99
506428	37043-1000	Seal housing - Quiet flush	1 lbs	32.99
502925	12 VDC	Motor only - 37010	5 lbs	162.99
	24 VDC		5 lbs	189.99
502926	12 VDC	Motor/Pump assembly - 37010	5 lbs	243.99
	24 VDC		5 lbs	275.99
500818	90197-0000	Service kit - Quiet flush	1 lbs	27.99
502927	12 VDC	Motor only - Quiet flush	4 lbs	131.99
	24 VDC		4 lbs	172.99
502910	12 VDC	Waste pump assembly - Quiet flush	5 lbs	199.99
	24 VDC		5 lbs	209.99
501525	37047-2000	Dual rocker panel switch	1 lbs	103.99
500797	37068-2000	Vented loop solenoid valve	1 lbs	91.99
502556	12 VDC	Solenoid valve & siphon breaker	1 lbs	135.99
	24 VDC		1 lbs	135.99

Item	Model	Description	Ship	Net
<b>JABSCO TOILET SEATS/HINGES</b> **Visit <a href="http://defender.com">defender.com</a> for complete application information				
500173	29097-1000	Seat/Lid/Hinge set kit - Compact	5 lbs	\$54.99
506358	29098-1000	Hinge set - Compact	1 lbs	14.99
506369	29127-1000	Seat/Lid/Hinge set kit - Household	7 lbs	68.99
549998	29098-2000	Hinge set - Household	1 lbs	13.99
502911	58104-1000	Seat/Lid/Hinge set kit - Deluxe	7 lbs	108.99
502912	58105-1000	Hinge set - Deluxe	1 lbs	27.99

Item	Model	Description	Ship	Net
<b>JABSCO MISC.</b>				
500346	18598-1000	Macerator service kit -18590/18690	1 lbs	\$63.99
506459	17288-1000	Macerator SS replacement studs (4)	1 lbs	17.99
502373	SK890	Waste pump service kit - 50890	1 lbs	33.99

Item	Model	Description	Ship	Net
<b>THETFORD MARINE/WILCOX CRITTENDEN PARTS &amp; KITS FOR TOILETS</b>				
500260	37057	1520 HEADMATE maintenance kit	1 lbs	\$72.99
500262	37070	1539 SKIPPER/SKIPPER II maintenance kit	1 lbs	141.99
500265	37058	1599 JUNIOR/IMPERIAL maintenance kit	1 lbs	114.99
502942	37059	1600 NEWPORT maintenance kit	1 lbs	146.99
502964	37307	Seat and cover package	5 lbs	51.99

Item	Model	Description	Ship	Net
<b>DOMETIC (FORMERLY SEALAND) MARINE TOILET PARTS</b>				
500382	385310076	Two 1.5" duckbill valves	1 lbs	\$32.99
503383	385311208	Two 2" duckbill valves	1 lbs	34.99
503392	385316140	Bowl seal kit-with overflow holes 2000-newer	1 lbs	42.99
503393	385311462	Bowl seal kit-w/o overflow holes 2000-newer	1 lbs	42.99
503382	385236096	Spring cartridge kit	1 lbs	39.99
503384	385318032	Vacuum tank switch kit	1 lbs	224.99
502751	385314349	Water valve kit	1 lbs	42.99

Item	Model	Description	Ship	Net
<b>DOMETIC (FORMERLY SEALAND) ODORSAFE PLUS SANITATION HOSE</b>				
502434	306342871	1-1/2"	1 lbs	\$9.99/ft

Item	Model	Description	Ship	Net
<b>WHALE WASTE PUMP SERVICE KITS</b>				
501278	AK1557	Service kit for Gulper toilet pump and Grouper-series	1 lbs	\$34.99
500875	AK8050	Service kit - Mk5 sanitation pump	1 lbs	56.99

Item	Model	Description	Ship	Net
<b>SHURFLO WASTE PUMP SERVICE KITS</b>				
503363	94-571-00	Impeller kit - 3200	1 lbs	\$39.99
503364	94-570-00	Impeller housing kit - 3200	1 lbs	70.99

**For additional parts, Data Sheets or Special Orders visit [www.defender.com](http://www.defender.com)**

# Raritan Electric Marine Heads

**ALL RARITAN SEAERA TOILETS NOW FEATURE A SLOW CLOSE LID**



## Raritan SeaEra Whisper Flush Toilet

• **CR** requires one of the wall mounted control options below

### ON-BOARD FRESH

- Uses onboard fresh water supply
- Eliminates raw intake water odors

### COMPACT/STANDARD MARINE **CR**

Specify: 12 VDC, 24 VDC or 120/240 VAC  
**D** Item 503755

Starting at \$554.99

### HOUSEHOLD/STANDARD MARINE **CR**

Specify: 12 VDC, 24 VDC or 120/240 VAC  
**D** Item 503756

Starting at \$589.99

## Raritan SeaEra™ and Raritan SeaEra Whisper Flush Electric Toilets

- Easy to clean and maintain
  - Sea/Lake models can run dry without damaging intake pump
  - On-board pressurized models include solenoid valve and atmospheric vacuum breaker for backflow prevention
- Inlet size: .75" Outlet size: 1" or 1.5" straight and 1.5"(only) 90° Discharge shape: Straight and 90° included  
 Macerating: Yes Amps: 13 On-board freshwater, 18 Sea/Lake  
 Water consumption: <1.5 quarts Warranty: 2 year

Marine bowl size: 14-1/2" H x 13" W x 17-1/4" D  
 Household bowl size: 14-7/8" H x 14-3/8" W x 20" D

### SEA-LAKE

- Uses raw sea or lake water
- Includes Whisper Flush™ remote pump for quiet operation

### COMPACT/STANDARD MARINE **CR**

Specify: 12 VDC, 24 VDC or 120/240 VAC  
**D** Item 503757

Starting at \$724.99

### HOUSEHOLD/STANDARD MARINE **CR**

Specify: 12 VDC, 24 VDC or 120/240 VAC  
**D** Item 503758

Starting at \$754.99

## Raritan SeaEra

### SEA-LAKE

- Integral pump • No additional control required

### STANDARD MARINE

Item	Model	Control	Ship	Net
<b>D</b> 502946	160M1012	Push button	49 lbs	\$580.99

### HOUSEHOLD

<b>D</b> 502947	160H1012	Push button	49 lbs	624.99
-----------------	----------	-------------	--------	--------

### SEAFRESH

- The only electric marine toilet that allows you to select from two separate intake flush water sources: On-board pressurized fresh water or Sea/Lake water

### COMPACT/STANDARD MARINE **CR**

Specify: 12 VDC, 24 VDC or 120/240 VAC  
 Item **D** 503759

Starting at \$874.99

### HOUSEHOLD/STANDARD MARINE **CR**

Specify: 12 VDC, 24 VDC or 120/240 VAC  
**D** 503760

Starting at \$914.99

**ALL RARITAN ELEGANCE TOILETS NOW FEATURE A SLOW CLOSE LID**



## Raritan Elegance Angled and Straight Back

• **CR** requires one of the wall mounted control options below

- Vortex-Vac flush technology, low water usage
- Small footprint for compact installation

- One piece vitreous china bowl
- 1 year warranty

Color: White Inlet size: 1/2", 3/4"

Outlet size: Fits 1" and 1.5" Macerating: Yes

Amps/12 VDC: Sea-Lake: 28 A, On-Board: 18 A Water

consumption: 1-1/2 pt (smart flush), 1-1/2 qt (multi-function)

Standard bowl: 14" H x 14" W x 18-3/8" D  
 Tall bowl: 17" H x 14" W x 18-3/8" D

Angle back footprint: 8.5" x 10.125"

Straight back footprint: 8.5" x 12.25"

### ON-BOARD FRESH

### ANGLED BACK/STANDARD **CR**

Specify: 12 VDC, 24 VDC or 120/240 VAC  
**D** Item 503733

Starting at \$599.99

### ANGLED BACK/TALL **CR**

Specify: 12 VDC, 24 VDC or 120/240 VAC  
**D** Item 503735

Starting at \$634.99

### STRAIGHT BACK/STANDARD **CR**

Specify: 12 VDC, 24 VDC or 120/240 VAC  
 Item 503734

Starting at \$629.99

### STRAIGHT BACK/TALL **CR**

Specify: 12 VDC, 24 VDC or 120/240 VAC  
**D** Item 503736

Starting at \$649.99

### SEA-LAKE

### ANGLED BACK/STANDARD **CR**

Specify: 12 VDC, 24 VDC or 120/240 VAC  
 Item 503737

Starting at \$799.99

### ANGLED BACK/TALL **CR**

Specify: 12 VDC, 24 VDC or 120/240 VAC  
 Item 503739

Starting at \$814.99

### STRAIGHT BACK/STANDARD **CR**

Specify: 12 VDC, 24 VDC or 120/240 VAC  
 Item 503738

Starting at \$814.99

### STRAIGHT BACK/TALL **CR**

Specify: 12 VDC, 24 VDC or 120/240 VAC  
 Item 503740

Starting at \$814.99

### SEAFRESH

### ANGLED BACK/STANDARD **CR**

Specify: 12 VDC, 24 VDC or 120/240 VAC  
 Item 503741

Starting at \$954.99

### ANGLED BACK/TALL **CR**

Specify: 12 VDC, 24 VDC or 120/240 VAC  
**D** Item 503743

Starting at \$964.99

### STRAIGHT BACK/STANDARD **CR**

Specify: 12 VDC, 24 VDC or 120/240 VAC  
 Item 503742

Starting at \$964.99

### STRAIGHT BACK/TALL **CR**

Specify: 12 VDC, 24 VDC or 120/240 VAC  
**D** Item 503744

Starting at \$964.99



**HOUSEHOLD ATLANTES TOILETS FEATURE A SLOW CLOSE SEAT**



## Raritan Atlantés Freedom with Vortex Vac

• **CR** Requires one of the wall mounted control options below

- Powerful vacuum, flushes without remote pumps
- Low power and water usage
- One piece China bowl available in Household and Elongated
- Anti-clog Vortex Vac discharge system
- Whisper quiet

Color: White bowl Macerating: Yes Inlet size: 1/2", 3/4"

Outlet size: 1", 1.5" Warranty: 1 year

Household bowl: 17" H x 14-3/8" W x 19-1/4" D  
 Elongated bowl: 17" H x 14-1/8" W x 21-1/2" D

### ON-BOARD FRESH

### HOUSEHOLD/TALL **CR**

Specify: 12 VDC, 24 VDC or 120/240 VAC  
 Item 503749

Starting at \$664.99

### ELONGATED/TALL **CR**

Specify: 12 VDC, 24 VDC or 120/240 VAC  
**D** Item 503750

Starting at \$899.99

### WITH HANDLE TIMED CONTROL

- No additional control required

Item 502770 Household/Tall 12 or 24 VDC Ship 60 lbs \$999.99

Item 502774 Elongated/Tall 12 or 24 VDC Ship 62 lbs 1039.99

### SEA-LAKE

### HOUSEHOLD/TALL **CR**

Specify: 12 VDC, 24 VDC or 120/240 VAC  
 Item 503751

Starting at \$849.99

### ELONGATED/TALL **CR**

Specify: 12 VDC, 24 VDC or 120/240 VAC  
**D** Item 503752

Starting at \$974.99

### WITH HANDLE TIMED CONTROL

- No additional control required

Item 502778 Household/Tall 12 or 24 VDC Ship 60 lbs 1164.99

Item 502782 Elongated/Tall 12 or 24 VDC Ship 64 lbs 1194.99

### SEAFRESH

### HOUSEHOLD/TALL **CR**

Specify: 12 VDC, 24 VDC or 120/240 VAC  
 Item 503753

Starting at \$1064.99

### ELONGATED/TALL **CR**

Specify: 12 VDC, 24 VDC or 120/240 VAC  
**D** Item 503754

Starting at \$1099.99

### WITH HANDLE TIMED CONTROL

- No additional control required

Item 502786 Household/Tall 12 or 2VDC Ship 60 lbs 1314.99

Item 502790 Elongated/Tall 12 or 2VDC Ship 67 lbs 1334.99

## WALL MOUNTED CONTROLS - REQUIRED TO COMPLETE YOUR SYSTEM

CR	Item	Model	Description	Ship	Net
	503747	164000BR	Push Button Control - Provides the ability to flush with no independent control of water or discharge	1 lbs	\$24.99
	503823	221551	Multi-function Control - Provides momentary operation and independent control of water and discharge	1 lbs	Starting at 179.99
	503745	STC**	Smart Toilet Control - Provides programmable timed operation and independent control of intake water and discharge volume	1 lbs	184.99
	503746	STCBL**	Smart Toilet Control with Bluetooth - offers wireless installation of the wall mount control. The toilet bowl can also be flushed, filled, or emptied up to 50' away via smartphone app.	1 lbs	234.99

## \*\*TANK SENSOR FOR SMART CONTROL

12/24 VDC. Plugs into any Raritan toilet utilizing the smart flush control.

Item	Model	Description	Ship	Net
503513	STCFL	Float style	1 lbs	\$89.99
503512	STCTSA	Stick on style	1 lbs	72.99



## JABSCO ELECTRIC TOILET

- Dual function pump rinses bowl, macerates and discharges
- One-touch electric push button
- All stainless steel and bronze fasteners

**Color:** White **Seat height:** Compact=13-13/16" Household=14-5/8" **Inlet size:** 5/8" or 3/4" **Outlet size:** 1" or 1-1/2" **Discharge angle:** 70° **Macerating:** Yes **Amps:** 16 A @ 12 VDC, 8 amps @ 24 VDC **Water consumption:** 4-6 gallons per minute **Warranty:** 1 year

### RINSE WATER SOURCE: RAW/SEA-LAKE

#### COMPACT/STANDARD MARINE

Item	Model	VDC	Ship	Net
ⓓ 506486	37010-3092	12	35 lbs	\$491.99
	37010-3094	24	35 lbs	492.99

#### HOUSEHOLD/STANDARD MARINE

Household bowls feature soft close lids

Item	Model	VDC	Ship	Net
ⓓ 506487	37010-4192	12	39 lbs	\$502.99
	37010-4194	24	39 lbs	502.99

**Compact Dimensions:**  
13-13/16" H x 13-7/8" W x 19-3/4" D  
**Household Dimensions:**  
14-5/8" H x 14-3/4" W x 21-3/4" D



## JABSCO QUIET-FLUSH ELECTRIC TOILET

- Single button flush actuator - with dual function water level control switch
- Fresh water version includes solenoid with breaker valve; raw water version includes Parmax 4 pump

**Color:** White **Inlet size:** 3/4" **Outlet size:** 1" **Discharge:** 70° **Macerating:** Yes **Amps:** 10=12 VDC, 5=24 VDC **Water consumption:** 1-2 qts. **Warranty:** 1 year

### RINSE WATER SOURCE: ON-BOARD PRESSURIZED FRESHWATER

#### COMPACT/STANDARD MARINE

Item	VDC	Control	Ship	Net
ⓓ 506488	12	Multi-function	41 lbs	\$627.99
ⓓ	24	Multi-function	41 lbs	627.99

#### HOUSEHOLD/STANDARD MARINE

Household bowls feature soft close lids

Item	VDC	Control	Ship	Net
ⓓ 506489	12	Multi-function	39 lbs	\$638.99
ⓓ	24	Multi-function	39 lbs	638.99

### RINSE WATER SOURCE: RAW/SEA-LAKE

#### COMPACT/STANDARD MARINE

Item	VDC	Control	Ship	Net
ⓓ 506490	12	Multi-function	41 lbs	\$627.99
ⓓ	24	Multi-function	41 lbs	627.99

#### HOUSEHOLD/STANDARD MARINE

Household bowls feature soft close lids

Item	VDC	Control	Ship	Net
ⓓ 506491	12	Multi-function	39 lbs	\$638.99
ⓓ	24	Multi-function	39 lbs	638.99

▲ Please Specify: 12 or 24 VDC

**Compact Dimensions:**  
14" H x 13-1/8" W x 16-13/8" D  
**Household Dimensions:**  
14-3/8" H x 14-3/4" W x 18-7/8" D



## GROCO MODEL K-H ELECTRIC

- Big piston pump with Teflon® rings for clog-free service converts to hand operation by removing one easily accessible bolt
- All bronze construction makes it extremely dependable

**Color:** White **Inlet size:** 3/4" or 1" **Outlet size:** 1.5" **Discharge shape:** Swivels 180° **Macerating:** No **Amps:** 25 **Water consumption:** Adjustable flow up to 4 GPM **Warranty:** 1 year

### SEA-LAKE

#### HOUSEHOLD/STANDARD MARINE

Item	Model	Control	Ship	Net
500341	K-H 12V	Push button	60 lbs	\$1520.99
501207	K REGULAR	Service kit	1 lbs	102.99

**Bowl Size:**  
16-3/4" H x 15-5/8" W x 18-3/4" D



## DOMETIC (FORMERLY SEALAND) MASTERFLUSH® 7100 & 7200 SERIES WITH ORBIT BASE DESIGN

- 360° bowl-to-base rotation which allows virtually limitless positioning to accommodate small spaces
- Integrated electric water valve on freshwater models • Standard single-function flush switch\*

**Seat height:** 14-3/4" (Household), 13-1/4" (Compact) **Inlet size:** 1/2" or 3/4" **Outlet size:** 1-1/2" **Macerating:** Yes, dual stage **Amps:** 20=12 VDC, 10=24 VDC **Water consumption:** < 1/3 gallon

### RINSE WATER SOURCE: ON-BOARD PRESSURIZED FRESHWATER

#### HOUSEHOLD/MEDIUM (7100 SERIES)

Item	Control	Ship	Net
ⓓ 502340	Rocker switch	65 lbs	\$419.99

#### COMPACT/LOW PROFILE (7200 SERIES)

ⓓ 502342	Rocker switch	68 lbs	419.99
----------	---------------	--------	--------

### RINSE WATER SOURCE: RAW/SEA-LAKE

#### HOUSEHOLD/MEDIUM (7100 SERIES)

Item	Control	Ship	Net
ⓓ 502341	Rocker switch	66 lbs	\$419.99

#### COMPACT/LOW PROFILE (7200 SERIES)

ⓓ 502343	Rocker switch	65 lbs	419.99
----------	---------------	--------	--------

▲ Please specify: 12 or 24 VDC

**Household/Medium Size:**  
14-3/4" H" x 19" D x 15" W  
**Compact/Low Profile Size:**  
13-1/4" H x 18-3/4" D x 14-1/2" W



\*Or optional triple-function\*flush/add water/dry bowl\* switch (freshwater flush models only)

## TECMA EASYFIT ECO SERIES ELECTRIC TOILET

- Eco-friendly – saves water
- Quiet, contemporary, space-saving design
- Vitreous china with wooden seat

**Color:** White **Inlet size:** .75" **Outlet size:** 1.5" **Macerating:** Yes **Amps:** 30 Amps @ 12 VDC **Warranty:** Limited 2 year

### RINSE WATER SOURCE: CHOOSE ONE BELOW (A)

**Must purchase compatible kit below (A) to complete your system**

#### HOUSEHOLD/SPECIFY HEIGHT

Item	Control	Ship	Net
ⓓ 501499	Eco rocker switch*	59 lbs	\$664.99

▲ Please Specify: High-Profile or Low Profile

**High-profile Dimensions:**  
17.4" H x 18.7" D x 14.3" W  
**Low-profile Bowl Size:**  
14.3" H x 18.7" D x 14.3" W



Eco Rocker Switch (included with A kits)



## TECMA NANO ECO & NANO PREMIUM PLUS TOILETS

- Compact design with the feel of a larger toilet • Turbine technology produces a powerful, clog-resistant flush
- Color: White • 12 VDC

**Inlet size:** 3/4" **Outlet size:** 1-1/2" **Amps:** 30 Amps @ 12 VDC

**Dimensions:**  
11.6" H x 14.6" W x 17.5" D

### NANO ECO - HOUSEHOLD LOW PROFILE

#### RINSE WATER SOURCE: CHOOSE ONE BELOW (A)

**Must purchase compatible kit below (A) to complete your system**

Item	Control	Ship	Net
502569	Eco rocker switch*	48 lbs	\$539.99

\*Eco rocker switch included with below inlet options

#### A TECMA EASYFIT ECO & NANO ECO - INLET DEVICE OPTIONS

• Eco-series inlet water options (required) – **Choose one**

Item	Model	For Easyfit Eco Series	Ship	Net
501500	38670	Fresh water solenoid kit	2 lbs	\$69.99
501503	38679	Raw water rinse/flush applications (with pump)	8 lbs	159.99
501502	38671	Raw water rinse/flush applications (without pump)	3 lbs	69.99

### NANO PREMIUM PLUS - HOUSEHOLD LOW PROFILE

#### RINSE WATER SOURCE: CHOOSE ONE BELOW (B)

**Must purchase compatible kit below (B) to complete your system**

Item	Control	Ship	Net
502570	Premium Plus flush controller	49 lbs	\$669.99

#### B TECMA NANO PREMIUM PLUS INLET DEVICE OPTIONS

• Premium Plus inlet water options (required) – **Choose one**

Item	Model	For Nano Eco and Nano Premium	Ship	Net
502746	38859	Fresh water solenoid kit	1 lbs	\$26.99
502748	38862	Raw water rinse/flush applications (with pump)	6 lbs	139.99
502747	38861	Raw water rinse/flush applications (without pump)	1 lbs	26.99



Eco Rocker Switch (included with A kits)\*



Premium Plus Flush Controller (included with Premium Toilet)

## Waste/Macerator Pumps

### JABSCO RUN DRY MACERATOR PUMPS

- Inlet port with both a 1-1/2" hose barb and 1-1/2" male pipe thread
- Waste passes through 1" hose barbed discharge port at 12 GPM
- Can empty a 30 gallon holding tank in less than 3 minutes
- Self-priming to 5'



Please specify: 12 VDC or 24 VDC

Item	Model	VDC	Amps	Fuse	L" x W" x H"	Ship	Net	
502929	18590-2092	12V	12	16	20	11-9/16 x 4-11/16 x 3-1/4	6 lbs \$139.99	
	18590-2094	24V	24	8	15	11-9/16 x 4-11/16 x 3-1/4	6 lbs 199.99	
500346	18598-1000	Macerator pump service kit for above						1 lbs 63.99
506459	17288-1000	Replacement stainless steel studs kit for above						1 lbs 17.99

### JABSCO SINGLE-DIAPHRAGM FILTERLESS WASTE PUMP

- "Straight through" waste path - no filter required
- 360° rotating head
- Capable of extensive dry running
- Self-priming
- Port size: 1-1/2"



Please specify: 12 VDC or 24 VDC

Item	Model	GPM	VDC/Draw	Ship	Net
502928	50890-1000	12V	5	12/8 A	7 lbs \$280.99
	50890-1100	24V	5	24/2.5 A	7 lbs 284.99

### RARITAN MACERATOR PUMP

- All stainless steel bolts to avoid corrosion
- Spring-loaded Viton® shaft seal is used to prevent leaks
- Proprietary rubber impeller compound allows longer dry running time
- Optional waste valve assembly isolates the waste matter from the pump during maintenance
- Inlet: 1-1/2" hose barb and 1-1/2" MNPT • Outlet: 3/4" MNPT



Please specify: 12 VDC or 24 VDC

Pump with standard barb fitting								
Item	Model	GPM	VDC	Amps	Ship	Net		
503449	53100-12	11	12	10.9	5 lbs	\$189.99		
	53100-24	11	24	5.4	5 lbs	194.99		
503509	53100RK	Macerator pump repair kit for 53100 Series						1 lbs 46.99
Pump with gate waste valve								
503450	53101-12	11	12	10.9	6 lbs	\$224.99		
	53101-24	11	24	5.4	6 lbs	234.99		
503510	53101RK	Macerator pump repair kit for 53101 Series						1 lbs 49.99

### WHALE GULPER WASTE PUMPS

- Can pump unmacerated waste
- Rotatable inlet and outlet
- Self-priming - runs dry without damage
- Large single diaphragm



Please specify: 12 VDC or 24 VDC

Gulper Toilet Pump-Toilet-Blackwater							
Item	Model	GPM	Hose	VDC/Draw	Ship	Net	
501320	BP2552B	4.75	1-1/2"	12/6.5 A	6 lbs	\$244.99	
	BP2554B	4.75	1-1/2"	24/3.25 A	6 lbs	254.99	
Gulper Grouper Mk 2 Fishbox Discharge Pump							
503387	BP4672	4.75	1", 1-1/2"	12/7A	5 lbs	\$159.99	
	BP4674	4.75	1", 1-1/2"	24/3.5 A	5 lbs	159.99	

### SHURFLO MACERATOR/FISHBOX EVACUATION PUMP

- High powered with seamless, splashproof shell and design
- Impeller with run-dry capability, including o-ring sealed end bells and sealed manual turn key
- Thermal and ignition protected



1 Year Warranty!

Item	Model	Description	Ship	Net
503460	3200-001	12 VDC, 13 GPM	6 lbs	\$158.99
	3200-011	24 VDC, 13 GPM	6 lbs	199.99
501628	3200-101	12 VDC, 13 GPM, 180° Port	6 lbs	158.99

### JOHNSON PUMP TA3P10-19 MACERATOR PUMP

Built-in thermal overload protection automatically shuts pump off when dry. Self-priming pump. Salt water tough 316 S/S hardware and base. 12 VDC. H 3.23" x W 4.25" x L 9.06". 1 year warranty.



Item	Model	Amp	GPM	Fuse	Inlet	Discharge	Ship	Net	
500437	10-24453-01	15	10	20	1-1/2"	1"	5 lbs	\$114.99	
503033	09-45595-01	Macerator kit for TA3P10-19						1 lbs	42.99

### GROCO 155 SERIES SUBMERSIBLE MACERATOR PUMP

This pump is SweetTank™ compatible. Waste is macerated before it leaves the tank so a smaller discharge hose and overboard seacock (3/4" outlet) can be used. Fits holding tanks 10" deep.



Item	VDC	Amp	GPM	Ship	Net
502348	12	20	17	9 lbs	\$484.99
	24	20	17	9 lbs	519.99

### DOMETIC (FORMERLY SEALAND) T-SERIES DISCHARGE PUMP

- Can run dry without damage
- Bellows-style pump has no impeller to burn up and still handles tough marine waste
- Self-priming up to 10' of water



Please Specify: 12 or 24 VDC

Item	Amp	GPH	Ship	Net
503394	6 (12 VDC)/3 (24 VDC)	300	8 lbs	\$294.99

## Waste Treatment Systems

### RARITAN PURASAN EX WASTE TREATMENT SYSTEM - TYPE I MSD

For vessels up to 65'.

- USCG Certified Type I waste treatment system
- Neutralizes bacteria in waste water via Purasan chlorinating tablets
- Macerates and treats waste for discharge
- Low power consumption and quiet operation
- Neutralizes bacteria in waste water
- Easy to maintain and change tablet dispenser
- Accommodates most marine toilets (up to two toilets)
- Alleviates need for holding tanks
- 13-1/2" H x 8-3/4" D x 16" W



Please specify: 12 or 24 VDC

Item	Model	VDC/Amps	Description	Ship	Net
503333	PST12EX	12/10	Purasan EX with switch	37 lbs	\$1624.99
	PST24EX	24/8	Purasan EX with switch	37 lbs	1854.99
756045	41-135A	Waste treatment (6 tablets) cartridge		3 lbs	69.99

### RARITAN ELECTRO SCAN WASTE TREATMENT SYSTEM TYPE I MSD

For vessels up to 65'.

- USCG Certified waste treatment system
- Coated electrodes use salt water to kill bacteria and viruses without harmful chemicals
- Requires sea water salinity or salt feed tank
- LCD display provides current and historical data
- Discharges with treatment levels that are safe and environmentally friendly
- 12 VDC (24 and 32 VDC available by Special Order)
- 13-1/2" H x 9-3/4" D x 16" W



Item	Model	VDC/Amps	Description	Ship	Net
503707	EST12	12/37	Electro Scan	24 lbs	\$1324.99
	EST24	24/27	Electro Scan	24 lbs	1554.99
	EST32	32/25	Electro Scan	24 lbs	1684.99
500022	31-3001	2 gallon salt feed tank unit		4 lbs	121.99
500385	32-5000	12 VDC Electrode pack		1 lbs	394.99

### RARITAN PURASAN EX HOLD N' TREAT SYSTEM

- Legal in all waters
- This system combines your choice of the Electroscan or Purasan EX, a USCG certified Type I marine sanitation device (MSD) with a Type III 15 gallon holding tank and macerator
- It is the only unit of its kind for vessels under 65'
- 3 settings: Automatic, No-discharge and Manual
- Environmentally friendly and treats waste to a level of 10 coliform bacteria per 100 ml of water, exceeding current Type I standards
- 16" W x 13-1/2" H x 8-3/4" D



Item	Model	VDC	Description	Ship	Net
503709	21SRP1512	12	Purasan EX Hold N' Treat	64 lbs	\$2699.99
503709	21SRP1524	24	Purasan EX Hold N' Treat	64 lbs	2854.99

### RARITAN ELECTRO SCAN HOLD N' TREAT SYSTEM

- Legal in all waters
- This system combines the ELECTRO SCAN, a USCG certified Type I marine sanitation device (MSD), macerator and a Type III 15 gallon holding tank
- Three settings: Automatic, No-discharge and Manual
- Can process 140 gallons of waste per week
- When sewage can be discharged, the waste transfer pump moves waste from the holding tank to the Type I MSD where it undergoes treatment before it is safely and legally discharged



Item	Model	VDC	Dimensions	Ship	Net
503708	21SR1512	12	18-1/4" H x 26" D x 18-1/2" W	64 lbs	\$2624.99

## Holding Tank Systems

### DOMETIC (FORMERLY SEALAND) HTS-T HOLDING TANK SYSTEMS

Includes Dometic Tank Monitor system, full-level safety shut-off, TankSaver® relief valve, SaniPump™ discharge pump, ECO vent filter (except item 501652) and (2) discharge outlets.

All models are 12 VDC.

Item	Model	Capacity	Ship	Net
501652	322721012	10 gal.	49 lbs	\$854.99
501653	322012812	28 gal.	65 lbs	1084.99
501654	322014012	40 gal.	99 lbs	1154.99





## Holding Tank Systems

### DOMETIC (FORMERLY SEALAND) WASTE HOLDING TANKS

- Solid, one-piece construction, no seams to leak
- Unmatched durability, strong 3/8" thick polyethylene
- 3" inspection port and cap with 5/8" vent fitting and (2) 1-1/2" inlet/outlet ports
- Variety of shapes and sizes. Up to 52 gallons



Item	Model	Capacity	Dimensions L" x W" x H"	Ship	Net
501451	322840122	11 gal.	24.5" x 8.25" x 17.75" Vertical	28 lbs	\$364.99
500789	322840121	11 gal.	15.28" x 10.75" x 14.5" Horizontal	34 lbs	364.99
502987	322840151	15 gal.	22" x 19" x 15" Horizontal	49 lbs	464.99
502988	322840202	18 gal.	28.28" x 11.5" x 16.75" Vertical	60 lbs	409.99
502989	322840201	18 gal.	28.25" x 14.25" x 14" Horizontal	35 lbs	409.99
501453	322800251	25 gal.	21" x 17" x 20.5" Horizontal	57 lbs	374.99
502990	322840301	28 gal.	30" x 20" x 14.5" Horizontal	65 lbs	424.99
502991	322840401	34 gal.	30" x 21.75" x 16" Horizontal	59 lbs	474.99
753760	307238685	Holding tank cleanout kit		1 lbs	41.99
502436	385310660	Diptube discharge kit		3 lbs	41.98

### VETUS FLEXIBLE WASTE WATER HOLDING TANK



- These tanks have welded seams with extra welding at the corners, making them more resistant to higher pressures
- Tank includes (2) right angle 1-1/2" fittings and a pre-fitted 5/8" right angle breather nipple
- Filled tank height is approximately 12"



Item	Model	Capacity	Dimensions W" x L"	Ship	Net
501765	TANKV55	14-1/2 gal.	27" x 31"	6 lbs	\$259.99
501766	TANKV70	18-1/2 gal.	31" x 31"	6 lbs	344.99
501767	TANKV100	26-1/2 gal.	31" x 39"	7 lbs	354.99
501768	TANKV160	42-1/2 gal.	31" x 56"	9 lbs	509.99

❖ For more detailed product specifications and our complete selection visit [www.defender.com](http://www.defender.com) or call 800-628-8225. ❖

### TODD ECONOMY HOLDING TANKS

- One piece, heavy-wall polyethylene
- All openings are female NPT (Fittings not included)
- Molded-in threaded openings: Tank has (2) 1-1/2" and (2) 1/2"
- Use fitting relocation kits to plug existing openings and reposition them on tank

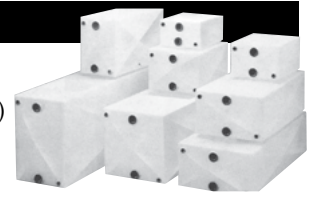

Item	Model	Capacity	Description L x W x H	Ship	Net
503126	85-1859WH	3 gal.	14" x 11" x 6-1/2"	6 lbs	\$67.99
503127	85-1531WH	6 gal.	16" x 12" x 8"	7 lbs	83.99
503128	85-1667WH	9 gal.	17" x 14" x 10"	11 lbs	99.99
503129	85-1626WH	13 gal.	24" x 10" x 14"	15 lbs	114.99
503130	94-1627WH	15 gal.	25" x 11" x 15"	31 lbs	120.99
503131	85-1666WH	20 gal.	30" x 16" x 10"	35 lbs	135.99
503132	85-1532WH	25 gal.	37" x 17-1/2" x 10"	45 lbs	162.99
503133	85-1525WH	35 gal.	36" x 15-1/2" x 16"	52 lbs	188.99
503134	85-1533WH	55 gal.	54-1/2" x 13" x 20"	100 lbs	251.99
501222	93-2220	N/A	Straight Pipe to Hose Adapter	1 lbs	24.99
501265	93-2221	N/A	90° Pipe to Hose Adapter	1 lbs	31.99

### TODD HOLDING TANK FITTING RELOCATION KIT

Contains: (1) Access plate, (2) 1-1/2" NPT plugs, (1) 1/2" NPT plug, (2) 1-1/2" thru hull fittings for fill and discharge, (1) 5/8" thru hull fitting, (6) Stainless steel screws, washers and nuts

Item	Description	Ship	Net
500365	90-2219	1 lbs	\$64.99

### NAUTA FLEXIBLE WASTE/DIESEL TANKS

- Rugged 840-denier nylon fabric, coated on both sides with a neoprene nitrite compound
- Vulcanized to assure leakproof panels and seams
- Fittings sold separately



Item	Gal.	Size	Ship	Net	FITTINGS All ship 1 lbs.	Net
500605	14-1/2	27" x 25"	5 lbs	\$279.99	90° fill 1-1/2"	\$31.99
500511	14-1/2	27" x 25"	6 lbs	354.99	Straight fill 1-1/2"	11.49
500606	25	27" x 34"	6 lbs	344.99	Straight draw nipple 1/2"	10.99
500607	37	27" x 46"	7 lbs	454.99	90° draw nipple 5/8"	24.99
300087	52.5	27" x 63"	9 lbs	599.99	Vent (fuel/holding) 5/8"	12.99

\*Includes installed fittings. No other fittings are required.

## Holding Tank Treatments & Accessories

### RARITAN K.O. KILLS ODORS

- Live, odor-killing bacteria digests liquids, solids, waste and paper
- Only 4 oz. of K.O. per 25 gallon tank neutralizes odor

Item	Size	Ship	Net
751160	22 oz.	2 lbs	\$14.99
751161	Gallon	9 lbs	46.99

### RARITAN C.P. CLEANS POTTIES! BIO-ENZYMATIC CLEANER

- Eliminates the worst raw odors from the intake line without brushing
- A safe, non-chemical, non-polluting product that destroys odors
- The only bowl cleaner that can be combined with K.O. (Kills Odors)

Item	Size	Ship	Net
501117	22 oz.	2 lbs	\$14.99

### RARITAN C.H. (CLEANS HOSES)

- Recommended for Lectra/San and Electroscan
- Removes uric scale (From black water system) from the toilet to the tank without having to remove hoses

Item	Size	Ship	Net
751915	Gallon	13 lbs	\$99.99

### STAR BRITE TOILET BOWL CLEANER AND LUBRICANT

- Removes stains and water deposits from bowls quickly and easily
- Excellent for cleaning and deodorizing all plastic and china bowls

Item	Size	Ship	Net
754126	16 oz.	2 lbs	\$8.99

### THETFORD ECOSMART TOSS-INS

- Holding tank deodorant and clog prevention • Liquefies waste and tissue
- Dissolvable packets

Item	Model	Description	Ship	Net
503198	32952	(12) per pouch	2 lbs	\$12.99

### THETFORD TANK BLASTER

- Formulated for black water, gray water and portable tanks • Enzymatic blend blasts crud and attacks tissue, waste, and grease • 1 packet cleans up to 50 gallon tank

Item	Model	Description	Ship	Net
503824	96527	4-pack	2 lbs	\$8.99

### THETFORD AQUA-KEM MARINE HOLDING TANK DEODORANT & CLEANER

- Powerful detergents clean tank walls and drain lines • Liquefies waste and breaks down tissue fast • 100% biodegradable liquid and environmentally safe

Item	Model	Description	Ship	Net
756063	94082	Pouch of (6) dissolving 2 oz. packs	1 lbs	\$14.99
756064	94080	(6) Pack of 8 oz. bottles	4 lbs	20.99
756065	94079	32 oz. bottle	3 lbs	13.99
503763	96318	24 single-dose packages	2 lbs	27.99

### TRAC ECOLOGICAL SEW CLEAN® CONCENTRATE

- Black water system cleaner, non-corrosive • Safe, non-toxic and biodegradable • Concentrate makes 5-8 gallons • Dissolves scale build up

Item	Model	Size	Ship	Net
751628	1218-MG	1 Gallon	13 lbs	\$57.99



### DOMETIC (FORMERLY SEALAND) MAX CONTROL ADVANCED GRANULATED HOLDING TANK DEODORIZER

- Control head and holding tank odor with this powerful deodorizer
- Breaks down waste and toilet tissue • 100% biodegradable

Item	Model	Description	Ship	Net
503769	379711001	(12) 1.5 oz. packets in plastic tub	2 lbs	\$15.99



### DOMETIC (FORMERLY SEALAND) MAX CONTROL ADVANCED TANK DEODORANT

- Contains effective odor control ingredients for fast, instant action
- Powerful cleaning formula breaks down waste and tissue

Item	Model	Description	Ship	Net
753911	379700025	(3) 2 oz. pouches	1 lbs	\$5.99
754056	379700027	32 oz. liquid	3 lbs	15.99
754292	379700026	Gallon jug	9 lbs	31.99



### DOMETIC (FORMERLY SEALAND) ECO HOLDING TANK VENT FILTER

This filter is the one replacement cartridge that fits all SeaLand ECO filter sizes.

- Fits in the same space and brackets as previous SeaLand vent filters for easy change-over
- Kit includes fitting for popular vent hose ID sizes: 5/8", 3/4", 1", and 1-1/2" (16 mm, 19 mm, 25 mm, and 38 mm)
- Improved malodorous gas filtration • Earth-friendly, recyclable plastic components
- Filter cartridge uses 55% less plastic than previous SeaLand vent filter cartridge

Item	Model	Description	Ship	Net
503469	309311001	Filter with bracket and fittings	2 lbs	\$99.99



### DOMETIC (FORMERLY SEALAND) MARINE TOILET PAPER

Safe for marine systems. 100% biodegradable, recycled, unbleached fiber; breaks up quickly and prevents clogs. 500 sheets per roll. 4 rolls per pack.

Item	Model	Description	Ship	Net
500471	379441204	1-ply, 4 rolls	1 lbs	\$4.59
501388	379441205	2-ply, 4 rolls	2 lbs	6.99



### OCEANAIR DRY ROLL TOILET PAPER HOLDER

High quality injection molded product fully protects toilet tissue in the head so spray or mist from a shower won't dampen the roll. White.

Item	Size	Ship	Net
500131	DR-W-RP	1 lbs	\$39.99



### GROCO SweetTank™ KIT

The SweetTank stops odors in holding tanks without the use of chemicals or filters. It introduces a constant flow of air into the tank. Requires less than 3 watts of DC power.

Item	Model	Voltage	Ship	Net
501838	STK-18 12V	12 VDC	3 lbs	\$343.99
	STK-18 24V	24 VDC	3 lbs	367.99

## Vented Loops, Valves, Connectors & Diverters

### RARITAN TRU-DESIGN VENTED LOOP

- Molded from glass-reinforced nylon composite with silicon bleed valve
- UV and chemical resistant suitable for all marine environments

Item	Model	Size	Ship	Net
503295	90462	3/4" with 12 Volt DC solenoid	1 lbs	\$109.99
503621	90319	3/4"	1 lbs	17.99
	90321	1"	1 lbs	20.99
	90323	1-1/2"	1 lbs	25.99



### FORESPAR MARELON® VENTED LOOPS- BLACK OR WHITE- All ship 1 lbs

Connect to discharge hose, above waterline, when head or holding tank is below waterline. Prevents backflow. Neither vent nor loop will corrode.

Item	Model	Select Hose Size	Starting At
502915		1/2", 5/8", 1"	\$32.99
502913		3/4" or 1-1/2"	26.99
502914	MF-841	Replacement cap assembly	Net 8.99
502437	MF-846	Vent barb assembly	Net 7.99



### GROCO HVL SERIES BRONZE VENTED LOOPS

- Assures clog-free, anti-siphon protection for sanitation or engine exhaust systems

Select inlet size: 1/2" ID, 3/4" ID, 1" ID, 1-1/2" ID

Item	Ship	Starting At
502917	3 lbs	\$112.99



### RARITAN TRU-DESIGN AQUAVALVE Y-VALVE KIT

- Two-way diverting valve designed to control the flow of treated or untreated sewage into a holding tank or treatment system
- Features a lockable handle and silicon seal for smooth movement

Item	Model	Description	Ship	Net
503663	90941	Manual Aqua valve with (3) straight 1-1/2" hose bars	2 lbs	\$89.99
503288	90942	Manual Aqua valve with (2) 120° elbows, (1) straight 1-1/2" hose bars	2 lbs	124.99
503289	90314	Aqua valve without fittings	1 lbs	69.99



### RARITAN TRU-DESIGN AQUAVALVE HOSE FITTINGS All ship 1 lbs Please specify size

Size	Item	Style	Net	Item	Style	Net	Item	Style	Net
1" fitting	503622	Straight	\$5.89	503623	90°	\$8.99	503624	120°	\$8.99
1-1/2" fitting		Straight	6.89		90°	9.99		120°	9.99

### WHALE DIVERTER Y-VALVE

- Allows one pump to draw from two locations
- TEFLON lubricated, non-stick operation
- Complies with USCG rules for Type 3 waste systems

Item	Model	Inlet/Outlet	Ship	Net
500518	DV5606	1-1/2" ID hose	2 lbs	\$77.99



### BOSWORTH SEA-LECT EASY-TURNING Y-VALVES

Compact "Y" valves eliminate extra fittings. Available in three different orientations to suit any application: inline, base-mount, or flush-mount. Corrosion resistant. Please specify port size.

Item	Port Sizes Available	Description	Ship	Starting at
503625	3/4", 1"	Inline Valve	1 lbs	\$34.99
503626	3/4", 1", 1-1/2"	Base Mount	1 lbs	36.99
503627	3/4", 1", 1-1/2"	Flush Mount	1 lbs	42.99



### ITT Y-VALVE PLASTIC DIVERTER VALVE

- Rotating ports
- Waste and corrosion resistant
- Can be padlocked to comply with local regulations
- Supplied with (2) 1-1/2" fitted discharge ports and (1) 1-1/2" fitted, straight inlet port
- (1) additional 1" straight inlet port is also supplied

Item	Model	Size	Ship	Net
500433	45490-1000	7-5/8" x 7-1/4" x 4-5/8"	2 lbs	\$83.99



### FORESPAR Y-CONNECTORS - All ship 1 lbs.

Connector can be used on the inboard side of a holding tank to connect 2 plumbing outputs to a single holding tank, and should not be used on the outboard side of a holding tank between the tank and the overboard discharge. Select size

Item	Select Size / Option	Starting At
503604	1" or 1-1/2" with or without flange.	\$23.99



### FORESPAR Y-VALVE DIVERTER

- Molded from high strength, non-corrosive Marelon®
- Easily mounted to a bulkhead
- Operated by a simple 120° movement
- Valve selects between waste discharge to holding tank or overboard (also for bilges)

Item	Model	Select Size	Ship	Net
503605	Y-Valve	3/4", 1", or 1-1/2" Barbed	1 lbs	\$54.99
500431	902006	Y-valve parts kit	1 lbs	20.99



## Tank Monitors

### DOMETIC (FORMERLY SEALAND) DTMO1P TANK MONITOR SYSTEM

- Probe and panel indicate when waste holding tank is full
- Probe assembly installs on virtually any rigid tank material
- Power: 12 or 24 Volt DC; Draw: 0.008 A

Item	Model	Color	Ship	Net
501421	313002311	Black	1 lbs	\$114.99



### DOMETIC (FORMERLY SEALAND) DTMO4 TANK MONITOR SYSTEM

Probes monitor tank at Empty, Low, Mid and Full. Easy-to-read panel. Includes tank cap, probe assembly, lighted indicator panel and Stainless Steel hardware. Optional vent hose connection. 12 or 24 Volt DC.

Item	Description	Ship	Net
502269	w/vent 22" probes	2 lbs	\$274.99
502270	w/o vent 22" probes	2 lbs	274.99
502271	w/vent 45" probes	2 lbs	289.99
502272	w/o vent 45" probes	2 lbs	289.99



### BLUE SEA SYSTEMS VSM 422 VESSEL SYSTEMS MONITOR

Includes head unit, surface mount bezel, surface mount gasket, DC current shunt 8255, AC current transformer 8256, battery temperature sensor 1820, connectors, and mounting screws. Monitors DC systems, AC systems, tank levels and bilge. Additional senders needed to monitor tanks.

Item	Model	Ship	Net
242260	1800	2 lbs	\$397.99



### BLUE SEA SYSTEMS DIESEL / WATER / WASTE TANK LEVEL SENDER

- For exclusive use with Blue Sea vessel systems monitor VSM 422
- For diesel, water or waste tanks up to 32" deep

Item	Model	Description	Ship	Net
242259	1810	Tank level sensor	1 lbs	\$99.99



### BLUE SEA SYSTEMS M2 OLED (ORGANIC LED) DIGITAL TANK MONITOR

- Measures essential parameters with adjustable alarms and an auto-dimming display
- Auto-dimming, bright Organic LED display is easy to read
- Power: 12/24/32 Volt DC, compatible with common sending units (Not Included)

Item	Model	Description	Ship	Net
205034	1839	Digital tank monitor	1 lbs	\$257.99



### SCAD TECHNOLOGIES PROFILE 1-8 TANK MONITOR

- Monitor levels of 1 to 8 tanks on a 4x20 backlit LCD display
- Autonomous monitoring and out-of-bounds alarms
- Compatible with capacitive level sensors, 240-33 OHM float sensors and 0-90 OHM LPG sensors

Item	Model	Ship	Net
501381	10019	1 lbs	\$371.99



### SCAD TECHNOLOGIES SOLO TANK MONITOR WITH EXTERNAL SENSOR

- Choose Full Alert for holding tank, Empty Alert for water tanks
- 12 Volt DC, .001 A, 2" x 3.5" display
- External sensor for plastic or (non-cored composite tanks) up to 3/4" thick

Item	Model	Ship	Net
501307	10024 for water tank	1 lbs	\$178.99
	10018 for holding tank	1 lbs	178.99



### TANK TENDER - TANK MONITOR SYSTEMS

Provides accurate readings without electricity. Simple to install. A typical 4-tank installation may read the contents of (1) fuel, (1) holding and (2) water tanks. DO NOT USE WITH GASOLINE! Ships direct from manufacturer.

Item	Model	Scale	Tanks	Max Water Tank Depth	Max Diesel Tank Depth	Ship	Starting at Net
503691	S30-1	30-35"	1	35"	30"	4 lbs	\$429.99
	S60-1	60-70"	1	60"	70"	4 lbs	439.99
503692	S30-2	30-35"	2	35"	30"	4 lbs	539.99
	S60-2	60-70"	2	60"	70"	4 lbs	559.99
503683	S30-3	30-35"	3	35"	30"	4 lbs	654.99
	S60-3	60-70"	3	60"	70"	4 lbs	684.99
503694	S30-4	30-35"	4	35"	30"	5 lbs	764.99
	S60-4	60-70"	4	60"	70"	5 lbs	809.99
503695	S30-5	30-35"	5	35"	30"	5 lbs	879.99
	S60-5	60-70"	5	60"	70"	5 lbs	934.99



### VDO VIEWLINE WATER LEVEL GAUGES/ SENDER UNIT

- Power: 12 / 24 Volt DC
- Cutout: 1-7/8", Dimensions: 2-1/16" dia.

Item	Model	Description	Ship	Net
305413	A2C53418137-S	Water level gauge- Onyx	1 lbs	\$48.99
305414	A2C53418382-S	Water level gauge- Ivory	1 lbs	48.99
301934	226-452	Fresh water level sender unit	2 lbs	203.99

A2C53418137-S





## Seacocks, Thru Hull Plugs & Shut Off Valves

### GROCO FLANGED SEACOCK - BV SERIES - UL LISTED

Tri-flange base and mount hole pattern provides easy retrofit when replacing most popular brands. Stainless steel ball and stem.  
 • Handle has square hole to accept standard ratchet • Full-Flow  
 • Serviceable while installed (requirement for passenger-carrying vessels)  
 • Drain plugs on both sides for efficient winterization  
 • Base has bonding attachment, PTFE seats and seals and a "Patented selectable handle (L or R) rotation"

Item	Model	Size	Ship	Net
503592	BV-750	3/4"	3 lbs	\$152.99
	BV-1000	1"	5 lbs	187.99
	BV-1250	1-1/4"	6 lbs	228.99
	BV-1500	1-1/2"	7 lbs	252.99
	BV-2000	2"	11 lbs	343.99

Additional sizes available at defender.com



### GROCO FLANGED SEACOCK - FBV SERIES - UL LISTED

Full-Flow. STD triangular base. Stainless steel handle, PTFE seats and seals, bonding attachment and drain plugs.

Item	Model	Size	Ship	Net
503591	FBV-750	3/4"	2 lbs	\$49.99
	FBV-1000	1"	3 lbs	65.99
	FBV-1250	1-1/4"	4 lbs	80.99
	FBV-1500	1-1/2"	5 lbs	111.99
	FBV-2000	2"	7 lbs	172.99
	FBV-2500	2-1/2"	14 lbs	303.99

Additional sizes available at defender.com



**APOLLO® SEA FLANGE VALVE** Bronze full ports, glass reinforced TFE seats and seals. Chrome-plated bronze ball. Stainless steel lever and nut. NPSM and NPT threads. Made in the USA! \*Large Flow Port

Item	Model	Size	Ship	Net
503599	78-115-01F*	3/4"	3 lbs	\$77.99
	78-118-01	1"	4 lbs	111.99
	78-119-01	1-1/4"	6 lbs	121.99
	78-116-01F*	1-1/2"	8 lbs	167.99
	78-120-01	2"	14 lbs	320.99
	78-117-01	2-1/2"	19 lbs	463.99



### GROCO BB-SERIES BACKING BLOCK

• 1/2" thick for a secure installation, will not swell or absorb moisture

Item	Model	Seacock Model	Seacock Size	Ship	Net
502614	BB-1	750 and 1000	3/4" and 1"	1 lbs	\$43.99
	BB-2	1250 and 1500	1-1/4" and 1-1/2"	1 lbs	54.99
	BB-3	2000 and 2500	2" and 2-1/2"	1 lbs	62.99
	BB-4	3000	3"	1 lbs	63.99

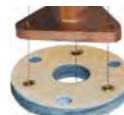

### GROCO IBVF SERIES BRONZE FLANGED ADAPTOR

• Allows standard NPT in-line valve to be used as a seacock  
 • Specify bottom and top port thread size

Item	Size	Ship
503462	3/4"-3"	6 lbs

SIZES 3/4" - 3" STARTING AT \$35.99



### GROCO IBV SERIES FULL FLOW INLINE BALL VALVE

• Bronze body with chrome plated solid brass ball  
 • Stainless Steel handle and hardware

Item	Model	Thread Size	Ship	Net
503590	IBV-750	3/4"	1 lbs	\$29.99
	IBV-1000	1"	2 lbs	46.99
	IBV-1250	1-1/4"	3 lbs	65.99
	IBV-1500	1-1/2"	4 lbs	89.99
	IBV-2000	2"	6 lbs	140.99

Additional sizes available at defender.com



**APOLLO 3-WAY DIVERTER & SHUT OFF VALVES** Fuel or water tank selection, oil transfer, etc. Bronze body, Stainless Steel lever, reinforced RPTFE seats and stuffing box ring, adjustable packing gland.

Item	Model	Size	Ship	Net
503601	70-603-10	1/2"	1 lbs	\$39.99
	70-604-10	3/4"	2 lbs	50.99
	70-605-10	1"	3 lbs	62.99
	70-606-10	1-1/4"	4 lbs	99.99
	70-607-10	1-1/2"	6 lbs	116.99
	70-608-10	2"	7 lbs	165.99



**APOLLO SHUT OFF VALVE** Bronze full port Apollo with mounting pads. Install with standard thru-hull or sea strainer. NPT threads.

Item	Model	Size	Ship	Net
503600	77-103-10	1/2"	1 lbs	\$28.99
	77-104-10	3/4"	2 lbs	47.99
	77-105-10	1"	4 lbs	68.99
	77-106-10	1-1/4"	6 lbs	89.99
	77-107-10	1-1/2"	7 lbs	111.99
	77-108-10	2"	12 lbs	199.99



### FORESPAR STA-PLUG™ SOFT CONE-SHAPED EMERGENCY PLUGS

• The adaptable alternative to the hard wooden bung plug  
 • Designed to conform to the unpredictable shapes of most hull breaches

Item	Model	Size	Ship	Net
552002	150110	9"(High) x 5"(Base)	1 lbs	\$16.99



### EMERGENCY WOOD PLUG SET

(6) plugs for holes from 1/2" to 2" dia. Made of tupelo wood to absorb water and swell to ensure against dislodging.

Item	Model	Ship	Net
552181	50501	1 lbs	\$9.99



## Thru-Hull Fittings

### GROCO STAINLESS STEEL THRU-HULL FITTINGS FOR HOSE - UL LISTED

Item	Size	Ship
502916	1/2", 3/4", 1", 1-1/4", 1-1/2"	1 lbs

SIZES 1/2" - 1-1/2" STARTING AT \$20.99



### APOLLO BN7-SERIES BRONZE MUSHROOM HEAD THRU-HULL

• Full threaded (Nut included)  
 • For connections above or below the waterline

Item	Size	Ship	Net
503461	1/2", 3/4", 1", 1-1/4", 1-1/2" or 2"	2 lbs	\$19.99

SIZES 1/2" - 2" STARTING AT \$19.99



EXTRA LONG THRU-HULLS AVAILABLE AT WWW.DEFENDER.COM

### GROCO THRU-HULL FITTING INSTALLATION TOOL

• Allows a single person to install thru-hull fittings

Item	Model	Fits	Ship	Net
501821	THT-530	1/2"-3" thru-hull fittings	2 lbs	\$66.99



## Strainers & Bronze Fittings

### APOLLO BRONZE HI-SPEED INTAKE STRAINER WITH NUT

Item	Size	Ship
502932	1/2", 3/4", 1", 1-1/4"	2 lbs

SIZES 1/2" - 1-1/4" STARTING AT \$34.99



### GROCO STH-L SERIES SCOOP THRU-HULL

• Cast bronze (Retaining nut is not included)  
 • Rated above/below waterline; Marine UL listed

Item	Size	Ship
503447	1/2", 5/8", 3/4", 1", 1-1/8", 1-1/4", 1-1/2", 2"	3 lbs

SIZES 1/2" - 2" STARTING AT \$23.99



### GROCO TH-SERIES THRU-HULL LOCK NUT

Please specify thread size

Item	Size	Ship
503446	1/2", 3/4", 1", 1-1/4", 1-1/2", 2", 2-1/2", 3", 4", 5"	5 lbs

SIZES 1/2" - 5" STARTING AT \$3.99



### GROCO BRONZE SC SERIES SLOTTED STRAINER

• Provides access to thru-hull fitting (Includes mounting ring)

Item	Size	Ship
503495	1", 1-1/2" or 2-1/2"	4 lbs

SIZES 1" - 2-1/2" STARTING AT \$39.99



### GROCO BRONZE RSC SERIES ROUND HULL STRAINER

• Provides access to thru-hull fitting  
 • Access door is secured with a clevis pin and cotter ring

Item	Size	Ship
503496	1", 2", or 4"	6 lbs

SIZES 1" OR 4" STARTING AT \$48.99



### GROCO BRONZE ASC SERIES SLOTTED HULL STRAINER

• Provides access to thru-hull fitting  
 • Access door is secured with a clevis pin and cotter ring

Item	Size	Ship
503497	1-1/4" - 6"	21 lbs

SIZES 1-1/4" - 6" STARTING AT \$85.99



### APOLLO PIPE TO HOSE ADAPTER (STRAIGHT BARBED)

• Full flow design and single piece construction  
 • Use with any Conbraco valve to adapt to a hose  
 • Made in the USA

Item	Size	Ship
503498	1/2 - 2-1/2"	2 lbs

SIZES 1/2" - 2" STARTING AT \$6.99



### APOLLO PIPE TO HOSE ADAPTER (90° BARBED)

• One piece - simplifies right angle connections

Item	Size	Ship
503499	3/4", 1", 1-1/4", 1-1/2", 2"	3 lbs

SIZES 3/4" - 2" STARTING AT \$18.99



### GROCO PN-SERIES PIPE NIPPLES 1/2"-4"

• Pipe thread to pipe thread  
 • Straight • Cast bronze

Item	Size	Ship
503493	1/2", 3/4", 1", 1-1/4", 1-1/2", 2", 2-1/2", 3", 4"	4 lbs

SIZES 1/2" - 4" STARTING AT \$7.49



### GROCO PNC-SERIES PIPE NIPPLES WITH CHECK

• Pipe thread to pipe thread • Orientation: Straight

Item	Size	Ship
503494	1/2", 3/4", 1", 1-1/4", 1-1/2", 2"	2 lbs

SIZES 1/2" - 2" STARTING AT \$17.99



**RARITAN TRUDESIGN SEACOCK ASSEMBLY**

• Seacock; skin fitting, collar, ball valve and straight tail



Item	Model	Thread	Ship	Net
503628	90943	1/2"	1 lbs	\$104.99
	90944	3/4"	1 lbs	109.99
	90945	1"	2 lbs	121.99
	90981	1-1/4"	2 lbs	144.99
	90946	1-1/2"	2 lbs	154.99
	90947	2"	3 lbs	209.99
503644	Installation tool - please specify size			1 lbs starting at 3.29

**FORESPAR MARELON**

Marelon® precision molded, glass-reinforced plumbing systems offer complete freedom from corrosion.

- U.L. approved, A.B.Y.C approved • Temperature range of Marelon is -40°F to +176°F.
- UL and ISO certified for above and below waterline

**FORESPAR MARELON FLANGE MOUNTING SEACOCKS**

NPSM type threads. All ship 2 lbs.

Item	Model	Thread	Hgt.w/Handle	Base	Net
503819	904009	1/2"	4"	3"	\$54.99
	904010	3/4"	4"	3"	56.99
	904011	1-1/2"	8"	6"	126.99



**FORESPAR MARELON PLUMBING BALL VALVE**

• Strong, lightweight and completely free from corrosion and electrolysis

Item	Model	Thread	Body Dia.	Body Length	Length w/Handle	Ship	Net
503783	905100	1/2"	1-7/8"	3"	4"	1 lbs	\$39.99
	905101	3/4"	1-7/8"	3"	4"	1 lbs	46.99
	905102	1"	2-3/4"	4-3/4"	5-1/2"	1 lbs	101.99
	905103	1-1/4"	2-3/4"	4-7/8"	5-3/4"	1 lbs	106.99
	905104	1-1/2"	3-1/2"	5"	7-1/2"	2 lbs	132.99
	905105	2"	4-1/4"	5-7/8"	8"	2 lbs	163.99

**FORESPAR MARELON SCOOP STRAINERS**

• Two-piece construction allows for easier installation • White

Item	Model	NPS Thread	Ship	Net
500546	906059	3/4"	1 lbs	\$29.99
500547	906060	1-1/4"	1 lbs	30.99



**FORESPAR MARELON THRU-HULLS**

• Below water line discharge fittings • Glass-reinforced nylon NPSM threads

**FULL THREADED MUSHROOM HEAD-251 SERIES**

• Please specify size

Item	Screen	Hose I.D.	Ship	Net
503516	No	Sizes ranging 1/2" - 2"	1 lbs	\$15.99
503326	Yes	3/4"	1 lbs	

**PRICES STARTING AT \$15.99**

**Full Threaded Flush Head - 250 Series at defender.com**

**FORESPAR 253 SERIES THRU-HULL BARBED END MUSHROOM HEAD TAILPIPES**

• Ideal thru-hull connector for use above and below the waterline

• Please specify size

Item	Hose I.D.	Ship	Net
503525	Sizes ranging 1/2" - 2"	1 lbs	\$15.99

**PRICES STARTING AT \$15.99**

**FORESPAR MARELON FULL-FLOW SEACOCK WITH MUSHROOM THROUGH-HULL**

• Includes Thru-hull, seacock with integrated hose barb

• Material: Glass reinforced nylon composite, ABYC H-27 compliant

• Compact footprint, no corrosion or electrolysis, select hose barb

Item	Barb Style	Barb Size	Ship	Net
503786	90-degree	Sizes ranging 1/2" - 2"	2 lbs	\$88.99
503762	Straight	Sizes ranging 1/2" - 2"	2 lbs	



**ATTWOOD POLYPROPYLENE THRU-HULLS FOR HOSE**

• For use with waste, water or bilge discharge above the water line

• Barbed connection for hose and clamp • Color: White

Item	Model	Size	Net	Item	Model	Size	Net
500440	3872-3	5/8"	\$5.99	500442	3874-3	1-1/8-1-1/4"	\$8.99
500441	3873-3	3/4"	5.99	500443	3875-3	1-1/2"	9.99



**WHITECAP NYLON THRU-HULL WITH STAINLESS STEEL FLANGE**

• For use with waste, water or bilge discharge above the water line

• Barbed connection for hose and clamp • All ship 1 lbs

• Please specify size • See defender.com for selection

Item	Orientation	Hose I.D.	Net
503527	Straight	Sizes ranging 5/8" - 2"	\$8.99
	90°	Sizes ranging 5/8" - 1-1/2"	

**PRICES STARTING AT \$8.99**



**WHALE PUMP SYSTEM PARTS**

Item	Model	Pipe Description	Ship	Net
500513	YP6114	Y connect 1-1/2"	1 lbs	\$13.99
500514	EB3364	Elbow 1"	1 lbs	10.99
500515	EB3488	Elbow 1-1/2"	1 lbs	11.99
500516	SB5865	Top strain 1" or 1-1/2", with valve	1 lbs	26.99
500517	SB4222	Side strain 1" or 1-1/2", with valve	1 lbs	26.99
500518	DV5606	Diverter 1-1/2", with valve	2 lbs	77.99

**WHALE NON-RETURN VALVE** Simple way to maintain prime in a section of discharge line

Item	Model	For Hose Size	Ship	Net
500512	LV1215	1" or 1-1/2"	1 lbs	\$22.99
500333	LV1219	3/4" or 1" inlet and outlet	1 lbs	20.99

**FORESPAR FEMALE PIPE THREAD BARBED FITTING**

• Made of high strength, glass-reinforced Marelon • More variations not listed

Item	Model	FPT Size	Hose Barb	Ship	Net
503526	901014	1/2"	5/8"	1 lbs	\$6.99
Please specify size	901015	3/4"	3/4"	1 lbs	7.49
	905014	1-1/2"	3/4"-1-1/2"	1 lbs	13.99



**FORESPAR TAILPIPES** All ship 1 lbs.

Made of high strength, glass-reinforced Marelon. Perfect choice for joining hose lines to Forespar ball valves and seacocks.

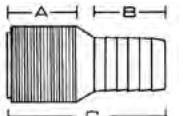

Item	Model	Thread"	Tailpipe"	A"	B"	C"	Net
503522	905006	1/2	5/8	1	1	2-1/4	\$7.99
	905007	3/4	3/4	1	1	2-3/8	7.99
Please specify size	905008	1	1	1-1/2	1-1/16	2-7/8	8.29
	905009	1-1/4	1-1/4	1-5/8	1-1/4	3-1/4	8.29
	905010	1 1/2	1-7/16	1-7/16	1-1/8	2-5/8	8.99
	905011	2	2	1-11/16	1-1/4	3-1/4	16.99

**FORESPAR MARELON ELBOWS - MALE AND FEMALE - BARB ON ONE END**

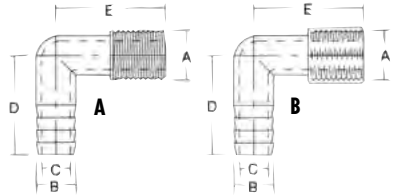

Elbows are molded from high-strength, glass-reinforced Marelon. All Forespar elbows sold in U.S.A. have parallel (straight pipe) NPSM type threads. All ship 1 lbs.

Item	Model	A"	B"	C"	D"	E"	Net
503523	901000-M	1/2	5/8	7/16	2	1-1/2	\$5.99
Male	901001-M	3/4	3/4	1/2	2-1/8	1-5/8	5.99
Please specify size	901002-M	1	1	5/8	2-1/2	1-7/8	6.99
	901003-M	1-1/4	1-1/4	7/8	2-3/4	2-5/16	7.49
	901004-M	1-1/2	1-1/2	1-1/16	3-1/4	2-3/4	10.99
503517	901006-F	1/2	5/8	7/16	2	1-5/8	6.99
Female	901007-F	3/4	3/4	9/16	2-3/16	1-3/4	6.99
	901008-F	1	1	5/8	2-1/2	1-7/8	6.99
Please specify size	901009-F	1-1/4	1-1/4	7/8	2-3/4	2-1/2	7.49
	901010-F	1-1/2	1-1/2	1-1/8	3-1/8	2-3/4	10.99
	901011-F	2	2	1-9/16	3-5/8	3-1/4	12.99

Forespar Clear Fittings available at Defender.com!

**Pipe and Hose Adapters**



**MARINE EAST MALE PIPE THREAD ADAPTERS** All ship 1 lbs

• High-strength, engineered plastic • Fits marine sanitation hose • Please specify size

Item	Model	MPT x Barb	Net	Item	Model	MPT x Barb	Net
502935	8901	1/2" x 3/4"	\$4.99	502935	8923	1" x 1-1/8"	\$4.99
	8902	1/2" x 1"	4.99		8925	1" x 1-1/2"	4.99
	8905	1/2" x 1-1/2"	4.99		8932	1-1/4" x 1"	4.99
Please specify size	8911	3/4" x 3/4"	4.99	Please specify size	8933	1-1/4" x 1-1/8"	4.99
	8912	3/4" x 1"	4.99		8935	1-1/4" x 1-1/2"	4.99
	8913	3/4" x 1-1/8"	4.99		8941	1-1/2" x 3/4"	4.99
	8915	3/4" x 1-1/2"	4.99		8942	1-1/2" x 1"	4.99
	8920	1" x 5/8"	4.99		8943	1-1/2" x 1-1/8"	4.99
	8921	1" x 3/4"	4.99		8944	1-1/2" x 1-1/4"	4.99
	8922	1" x 1"	4.99		8945	1-1/2" x 1-1/2"	4.99

**MARINE EAST BARB TO BARB HOSE ADAPTERS** Ship 1 lbs

• High-strength, molded engineered plastic • Fits marine sanitation hose • Please specify size

Item	Model	Size	Net	Item	Model	Size	Net
502934	8800	5/8" x 5/8"	\$4.99	502934	8855	1" x 1"	\$4.99
	8805	5/8" x 3/4"	4.99		8860	1" x 1-1/8"	4.99
	8810	5/8" x 1"	4.99		8865	1" x 1-1/4"	4.99
Please specify size	8815	5/8" x 1-1/8"	4.99	Please specify size	8875	1-1/8" x 1-1/8"	4.99
	8825	5/8" x 1-1/2"	4.99		8885	1-1/8" x 1-1/2"	4.99
	8830	3/4" x 3/4"	4.99		8890	1-1/4" x 1-1/4"	4.99
	8835	3/4" x 1"	4.99		8895	1-1/4" x 1-1/2"	4.99
	8840	3/4" x 1-1/8"	4.99		8899	1-1/2" x 1-1/2"	4.99
	8850	3/4" x 1-1/2"	4.99				

**JABSCO IN-LINE NON-RETURN VALVE**

Non-return valves help priming and prevent backflow of water into the bilge. There are three sizes for 3/4", 1" and 1 1/2" (19 mm, 25 mm and 38 mm) hose.



Item	Model	For Hose Size	Ship	Net
506494	29295-1011*	3/4" ID	1 lbs	\$26.99
	29295-1000	1" ID	1 lbs	26.99
	29295-1010	1-1/2" ID	1 lbs	26.99

\* Use for inlet non-return valve on 37010 series heads and to improve flushing with many raw water flush heads.





**Whale Quick Connect Fittings**

- For use with Whale plastic tubing and grooved stems only
- Making a watertight connection is an easy, two-step process with no special tools required
- Unique "double gripper" provides secure, lifelong tube retention even at excessive pressures. Collet has internal support ring ensuring O-ring seal is held in position and does not distort or leak under pressure
- Innovative, tube supporting "cage collet" design eliminates leaks where fittings are close to tight bends
- High integrity single piece molding improves the reliability and strength of the fittings
- Outer sleeve incorporates collet cover, thus preventing accidental tube release
- Tubing is 15 mm diameter with a minimum bend radius of 75 mm
- Designed for use in mobile applications
- 10 year manufacturer's warranty

Application	Pressure	Temperature
Hot water	90 PSI	150° F
Cold water	180 PSI	68° F

Item	Model	Description	Ship	Net
500093	WX1532(B)	1/2" BSP to 15 mm female adapter	1 lbs	\$5.99
500094	WX1542(B)	3/4" BSP to 15 mm female adapter	1 lbs	11.99
500095	WX1544(B)	1/2" hose connector (brass)	1 lbs	16.49
500096	WX1565(B)	Tube mounting clip 15 mm, Black	1 lbs	1.49
500097	WX1574(B)	Shut-off valve	1 lbs	18.49
500098	WX1582(B)	Check valve/non-return valve (brass) 15 mm	1 lbs	15.49
500092	WX1531(B)	Elbow adapter - 1/2" BSP female 15 mm	1 lbs	9.99
500091	WX1515(B)	Faucet tail assembly - 1/2" BSP male 15 mm	1 lbs	4.99
500090	WX1504(B)	Equal straight 15 mm	1 lbs	4.99
500087	WX1503(B)	Equal elbow 15 mm	1 lbs	4.99
500089	WX1502(B)	Equal tee 15 mm	1 lbs	6.49
500099	WX716	15 mm tubing - specify Red or Blue, sold per ft.	1 lbs/ft	1.49/ft
503153	WX7950	Tube cutter, used for Whale semi-rigid tubing	1 lbs	42.99
503575	WX1534	15 mm Quick Connect, 1/2" NPT male, brass	1 lbs	16.99
		Includes check valve		
503574	WX1524	15 mm Quick Connect, 1/2" NPT male, brass	1 lbs	14.99

**British Standard Pipe, Tapered (BSPT)**

The BSPT connection is similar to National Pipe Tapered Fuel (NPTF), except the thread pitches are different in most sizes. The thread form and outside diameters are close, but not the same. Sealing is accomplished by thread distortion. A thread sealant is recommended.

**British Standard Pipe, Parallel (BSPP)**

The BSPP connection is similar to National Pipe Straight Mechanical (NPSM), except the thread pitches are different in most sizes. The BSPP female swivel has a tapered nose/Globesal flareless swivel which seals on the cone seat of the male. While many users mistakenly identify BSPP fittings as metric, these fittings are actually measured in inches. Some Japanese (JIS 30°) fittings also use BSPP threads.

**Sea Tech Fittings**

- Zero-leak connections with the exclusive O-ring guide which protects the O-ring and correctly aligns the tubing
- Connect to multiple materials using stainless steel gripping teeth in the collets without the need for special tools or tube inserts
- Rotates under pressure - after a joint is made, the tubing can still swivel while connected, even under maximum pressure - ideal for vibrating/dynamic applications
- Highest flow - connectors join the tubing on the outside, increasing flow by more than 30%
- Create mini-manifolds - small lengths of tubing can be eliminated by using stackable connector configurations

Note: Sea Tech metric fittings are Black and Sea Tech 35 series standard imperial fittings are White.



35 Series		
Application	Pressure	Temperature
Hot water	100 PSI	180° F
Cold water	250 PSI	75° F
10 Series		
Application	Pressure	Temperature
Hot water	100 PSI	140° F
Cold water	250 PSI	75° F

**15 MM FITTINGS**

Item	Model	Description	Ship	Net
500134	1110-0815	Female connector, 15 mm x 1/2" NPS	1 lbs	\$5.49
500135	1115-1515	Union connector, 15 mm	1 lbs	4.99
500136	1116-1015	Reducing union, 15 mm x 1/2" CTS	1 lbs	5.49
500137	1117-1515	Union elbow, 15 mm	1 lbs	4.99
500138	1118-1515	Stackable elbow, 15 mm	1 lbs	5.49
500139	1120-0815	Female swivel elbow, 15 mm x 1/2" NPS	1 lbs	6.99
500140	1123-1515	Union tee, 15 mm	1 lbs	6.99
500141	1133-1515	Stackable tee, 15 mm	1 lbs	6.99
500142	1145-15	End stop, 15 mm	1 lbs	4.99
500143	1147-15	Collet clip, 15 mm, 3 per pack	1 lbs	1.39
500144	2402-0815	Male connector, 15 mm x 1/2" NPT	1 lbs	4.99
500145	2413-0815	Hose barb fitting, 15 mm x 1/2" H.B.	1 lbs	7.99
500147	2439-1515	Stop valve, 15 mm	1 lbs	19.99

**35 SERIES CTS FITTINGS**

503610	3501-1008	Male connector, 1/2" CTS x 1/2" NPT	1 lbs	\$4.99
503611	3510-1008	Female connector, 1/2" CTS x 1/2" NPS	1 lbs	5.49
503612	3515-10	Union connector, 1/2" CTS	1 lbs	6.99
503613	3517-10	Union elbow, 1/2" CTS	1 lbs	5.99
503614	3518-10	Stackable elbow, 1/2" CTS	1 lbs	5.49
503615	3520-1008	Female swivel elbow, 1/2" CTS x 1/2" NPS	1 lbs	5.99
501524	3523-10	Union tee, 1/2" CTS	1 lbs	7.99
503616	3533-10	Stackable tee, 1/2" CTS	1 lbs	5.99
503617	3545-10	End stop, 1/2" CTS	1 lbs	4.99
500158	3547-10	Collet clip, 1/2" CTS, 3 per pack	1 lbs	1.49
501289	3539-10	In-line stop valve, 1/2" CTS	1 lbs	10.99

**PEX TUBING FOR SEATECH FITTINGS**

Item	Please Specify	Ship/Ft	Net/Ft.
501398	15 mm PEX tubing, Blue or Red	1 lbs	\$0.99/ft.
501303	1/2" PEX tubing, Blue or Red	1 lbs	0.99/ft.

**CTS** Copper Tubing Size

**NPS** Some Sea Tech connectors utilize a swivel nut with NPS straight threads and a cone seal. This allows the installer to thread onto NPT, NPS, BSP and most other threads without tools or thread sealant. Simply thread on, hand tight, for a zero-leak seal.



## Water & Heater Hose

### TRIDENT PREMIUM HEAVY DUTY BLACK RUBBER WATER AND HEATER HOSE

Heavy, wall-reinforced construction used for engine water, bilge, baitbox, air conditioner circulation and ice box, sink and shower drain lines. Resists sea water, mild chemicals and temperatures to 212°. Maximum water pressure of 200 PSI. 2 year warranty, except 134 series offers a 3 year warranty. All Ship 1 lbs per ft. Item **503531** Please specify hose size



Model	Size I.D.	Net/ft.	Model	Size I.D.	Net/ft.
132-012	1/2"	\$2.59	132-100	1"	\$3.49
132-058	5/8"	2.09	134-112	1-1/2"	8.99
132-034	3/4"	3.29			

## Sanitation Hose

### TRIDENT PREMIUM RUBBER SANITATION HOSE

Heavy duty hose for head and holding tank connections. Specially compounded rubber for maximum resistance to odor permeation and toilet chemicals. Extremely flexible. 10 year odor free warranty. 101/102 series.



Item	I.D. Size	Specify Color	Ship/Ft	Net/Ft
502617	1"	White or Black	1 lbs	\$7.99
501477	1-1/2"	White or Black	1 lbs	7.99

Bulk 50' rolls pricing available. Please call 800-628-8225.

### RARITAN SANI/FLEX SANITATION HOSE

- Made of butyl rubber which has the lowest odor permeation level
- Extremely flexible
- 5 year warranty

Item	Model	Size	Ship/Ft	Net/Ft
503529	SFHI	1"	1 lbs	\$9.99
	SFH	1-1/2"	1 lbs	10.49



### DOMETIC (FORMERLY SEALAND) ODORSAFE PLUS SANITATION HOSE

Provides one of the best odor barriers of any hose available in the marine industry. Color: White. Sold by the foot. 5 year warranty.

Item	Model	Size	Ship/Ft	Net/Ft
502434	306342871	1-1/2"	1 lbs	\$9.99



### TRIDENT EXTRA HEAVY DUTY PVC SANITATION HOSE

Smooth wall, extra heavy duty vinyl hose for all sanitation system connections and other critical applications. FDA approved. Excellent odor resistance. Color: White. All ship 1 lbs per ft.



Item **503532** Please specify hose size

Model	Size I.D.	Net/ft.	Model	Size I.D.	Net/ft.
148-058	5/8"	\$2.44	148-118	1-1/8"	\$3.73
148-034	3/4"	2.87	148-114	1-1/4"	4.27
148-100	1"	3.20	148-112	1-1/2"	4.27

### TRIDENT MARINE GRADE SANITATION AND FUEL HOSE CLAMPS - 4-PACK

- Applications: fuel and sanitation hose (Hoses with I.D. of 1-1/2" - 1-5/8")
- SAE Size 28
- Material: 316 stainless steel
- Non-perforated single piece housing
- Clamping range: 1-3/4" to 2-1/4"

Item **503492** Model 710-1120-4 Ship 1 lbs Net \$11.99



## Bilge/Livewell Hose

### TRIDENT BILGE HOSE

Heavy, corrugated polyethylene hose for bilge intake and discharge above the waterline. Outstanding flexibility. Molded cuffs every 12" for easy installation and clamping. Color: White. All Ship 1 lbs per ft.



Item **503533** Please specify hose size

Model	Size I.D.	Net/ft.	Model	Size I.D.	Net/ft.
120-034	3/4" dia.	\$1.41	120-114	1-1/4" dia.	\$1.92
120-118	1-1/8" dia.	1.51	120-112	1-1/2" dia.	2.33

### TRIDENT CORRUGATED DRAIN/BILGE HOSE

Flexible hose with smooth inner surface for potable water fill, holding tank pump out, drain lines and heavy duty bilge discharge. Not recommended for below waterline thru-hull connections. Clear with Black helix. All Ship 1 lbs per ft.



Item	Model	Size I.D.	Ship	Net/ft.	Item	Model	Size I.D.	Ship	Net/ft.
503816	144-034	3/4"	1 lbs	\$2.14		144-114	1-1/4"	1 lbs	\$2.72
	144-118	1-1/8"	1 lbs	2.46		144-112	1-1/2"	1 lbs	3.35

### TRIDENT XHD BILGE PUMP/LIVEWELL HOSE

For XHD bilge, livewell, drain, scupper lines, etc. and approved for below waterline. Smooth, extra heavy wall vinyl (FDA) well hose. Excellent durability, flexibility and bend radius. No cuffs required. For temperatures +10° to +120°F (-12° to +60°C). 3 year warranty. Clear with Black helix. All Ship 1 lbs per ft.



Item **503534** Please specify hose size.

Model	Size I.D.	Net/ft.	Model	Size I.D.	Net/ft.
147-058	5/8"	\$1.91	147-118	1-1/8"	\$2.87
147-034	3/4"	2.23	147-114	1-1/4"	3.51
147-100	1"	2.34	147-112	1-1/2"	4.48

## General Purpose Hose & Hose Clamps

### TRIDENT CLEAR PVC HEAVY DUTY TUBING

Single extrusion, non-toxic clear vinyl hose. FDA approved. For cool water uses like water lines, sinks, ice boxes and vent lines. All Ship 1 lbs per ft.

Item **503535** Please specify hose size

Model	Size I.D.	Net/ft.	Model	Size I.D.	Net/ft.
150-014	1/4"	\$0.70	150-058	5/8"	\$1.62
150-038	3/8"	0.90	150-034	3/4"	1.82
150-012	1/2"	1.41	150-100	1"	2.13



### TRIDENT REINFORCED PVC TUBING

Heavy duty, nylon reinforced tubing for hot or cold pressurized water systems and many other uses. Non-toxic, odorless, tasteless. FDA approved. Clear with Red/Blue tracer. All Ship 1 lbs per ft.

Item **503536** Please specify hose size

Model	Size I.D.	Net/ft.	Model	Size I.D.	Net/ft.
162-038	3/8"	\$1.00	162-034	3/4"	2.02
162-012	1/2"	1.31	162-100	1"	3.04
162-058	5/8"	1.82	161-112*	1-1/2"	6.10



### TRIDENT 165 SERIES BLUE RE-ENFORCED PVC POTABLE WATER HOSE

- Color: Blue (Cold water), Select diameter
- Material: FDA grade 3-ply polyester
- Sold by the foot, tested to withstand 4x its rated pressure

Item	Model	Hose ID	Ship/Ft	Net/Ft
503635	165-0380	3/8"	1 lbs	\$1.09
	165-0120	1/2"	1 lbs	1.29
	165-0580	5/8"	1 lbs	1.59
	165-0340	3/4"	1 lbs	2.15



### TRIDENT 166 SERIES RED RE-ENFORCED PVC POTABLE WATER HOSE

- Color: Red (Hot water ID), Select diameter
- Material: FDA grade 3-ply polyester
- Sold by the foot, tested to withstand 4x its rated pressure

Item	Model	Hose ID	Ship/Ft	Net/Ft
503636	166-0380	3/8"	1 lbs	\$1.09
	166-0120	1/2"	1 lbs	1.29
	166-0580	5/8"	1 lbs	1.59
	166-0340	3/4"	1 lbs	2.09
	166-1006	1"	1 lbs	2.99



### SCANDVIK / ABA SMOOTH BAND HOSE CLAMP

- No perforations in the band; Select clamping range
- Rolled-up band edges, Material: 316 stainless steel
- Pressed one-piece worm housing.
- Sold individually

Item **503668** All Ship 1 lbs

Model	Size	Band Width	Net	Model	Size	Band Width	Net
SAE #3	5/16"- 9/16"	3/8"	\$2.99	SAE #32	1-1/2"- 2-1/2"	1 1/2"	2.99
SAE #4	7/16"- 11/16"	3/8"	2.99	SAE #36	1-3/4"- 2-3/4"	1 1/2"	3.99
SAE #6	1/2"- 13/16"	3/8"	2.99	SAE #40	2"- 3"	1 1/2"	3.99
SAE #8	5/8"- 1"	1/2"	2.99	SAE #44	2-1/4"- 3- 1/4"	1 1/2"	3.99
SAE #10	3/4"- 1-1/8"	1/2"	2.99	SAE #48	2-1/2"- 3-1/2"	1 1/2"	3.99
SAE #12	7/8"- 1-1/4"	1/2"	2.99	SAE #52	2-3/4"- 3-3/4"	1 1/2"	3.99
SAE #20	1-1/4"- 1-3/4"	1/2"	2.99	SAE #56	3"- 4"	1 1/2"	4.99
SAE #24	1-1/2"- 2"	1/2"	2.99	SAE #60	3-1/4"- 4-1/4"	1 1/2"	4.99
SAE #28	1-1/4"- 2-1/4"	1/2"	2.99	SAE #72	3-1/2"- 5"	1 1/2"	6.99



Item **503669** All Ship 1 lbs

Model	Size	Band Width	Net
SAE #80	4" - 5-1/2"	1 1/2"	\$7.99
SAE #88	4-1/2" - 6"	1 1/2"	8.99
SAE #112	6" - 7-1/2"	1 1/2"	9.99
SAE #128	7" - 8-1/2"	1 1/2"	10.99
SAE #138	7-5/8" - 9-1/8"	1 1/2"	12.99
SAE #154	8-5/8" - 10-1/8"	1 1/2"	12.99
SAE #170	9-5/8" - 11-1/8"	1 1/2"	13.99
SAE #186	10-5/8" - 12-1/8"	1 1/2"	12.99

### SCANDVIK ABA 316 HOSE CLAMP CRUISER PACK

- Includes sizes from 7/16" to 2-1/2"
- Includes a flexible nut driver

Item	Model	Description	Ship	Net
501472	31606	56 hose clamps and flexible nut driver	4 lbs	\$145.99



### PYI HOSE CLAMP TIP JACKETS

- Applications: Standard hose clamp tips
- Material: EPDM rubber

Item	Model	Width	Package	Ship	Net
503579	CJ12.25	1/2"	25	1 lbs	\$6.99
	CJ12.100	1/2"	100	1 lbs	24.99
	CJ516.25	5/16"	25	1 lbs	6.99
	CJ516.100	5/16"	100	1 lbs	24.99



## Emergency Repair Tape

### LIFESAFE SOS SILICONE TAPE

- Withstands salt water, UV rays, acids and fuels
- No adhesive; self fusing
- Tensile strength of 600 PSI
- Will not melt up to +500°F
- Insulates to 8000 Volts (for 20 mil thick wrap)
- Remains flexible to -60°F
- Specify: Black or White

Item **756074** Roll Size: 1" x 10' Ship 1 lbs Net \$11.99

### ANCOR REPAIR TAPE

- Self-fusing when applied under tension
- No sticky residue remains
- Creates a permanent air and water tight seal
- Tear strength: 60 PPI
- Operates and remains flexible from -60°F to 500°F

Please specify: Black, Blue, Clear, Green, Gray, Red, White or Yellow  
Item **205018** Roll Size: 1" x 10' Ship 1 lbs Net \$8.99





**GENERAL ECOLOGY NATURE PURE QC2 PURIFIER**

- 0.8 GPM flow rate
- Easy installation
- Enhanced performance and convenience
- Chemical free water purification
- Replaceable canisters
- Meets EPA standards

Item	Model	Description	Ship	Net
503664	420600	With faucet	6 lbs	\$389.49
503665	420630	No faucet	6 lbs	299.99
503666	420620	Canister	3 lbs	100.54



**SEAGULL IV DRINKING WATER PURIFIER**

Seagull IV is independently certified to meet EPA guide standard protocol for microbiological purifiers against bacteria, cysts and viruses. Plus, Seagull IV systems excel at removing chemical and aesthetic contaminants including herbicides, pesticides, chlorine and foul tastes, odors and colors for great tasting water on demand.

Item	Model/Description	Ship	M.A.P.
500911	732000 Purifier with separate faucet; 1GPM	6 lbs	\$654.31
500913	703200 Manual pump, countertop unit, non-pressurized syst. .5 GPM (1.9 lpm)	4 lbs	777.51



**SEAGULL IV X-1B BASIC WATER PURIFIER KIT**

- Designed to route purified water through an existing faucet
- Rate: 1 GPM chemical free water purification
- Includes RS-1SG cartridge and installation kit with mounting hardware

Item	Model	Ship	M.A.P.
501716	732006	Ship 4 lbs	M.A.P. \$609.79



**SEAGULL IV X-1KF WATER PURIFIER**

- Includes Esprit faucet kit for filtered water
- Rate: 1 GPM chemical free water purification
- Includes RS-1SG cartridge and installation kit with mounting hardware

Item	Model	Ship	M.A.P.
501715	832820	Ship 8 lbs	M.A.P. \$834.45



**SEAGULL IV X-2KB WATER PURIFIER**

- Designed to route purified water through an existing faucet
- Rate: 2 GPM chemical free water purification
- Includes RS-1SG cartridge and installation kit with mounting hardware

Item	Model	Ship	M.A.P.
501718	832810	Ship 8 lbs	M.A.P. \$929.70



**SEAGULL REPLACEMENT CARTRIDGES**

Item	Model	Ship	M.A.P.
500914	788000 for Seagull IV X-1 series purifiers	2 lbs	\$116.16
501714	789000 for Seagull IV 2-K series purifiers	3 lbs	232.32

**SEAGULL DOCKSIDE PREFILTRATION SYSTEM**

Treats fresh water from marina to remove abrasive sand, dirt, rust and other particles to extend the life of on-board filters and to protect gel coat surfaces from abrasion when cleaning. Standard garden hose hook up. Flow Rate: 5 gpm Average capacity: 5,000 Gallon Dimensions: 12-1/2"H x 4-1/2"W Working pressure: 10 PSI

Item	Model	Description	Ship	M.A.P.
500915	610000	Dockside system with cartridge	5 lbs	\$185.32
500916	600001	Replacement cartridge	2 lbs	52.80



**BOJI WATER SOFTENING SYSTEM**

Can be installed in-line for dockside pressure water supply or can be used to fill your vessel's onboard water storage tank. Works the same as a conventional water softener; however, there are no time clocks, solenoids or directional valves to malfunction. No external power source is required.

Item	Model	Description	Ship	Net
502311	SS4015	Regular capacity	28 lbs	\$299.99
502312	SS6015	Hi-capacity	61 lbs	364.99
502313	C232	Replacement cartridge	1 lbs	16.99



**SHURFLO WATERGUARD FILTER HOUSINGS & REPLACEMENT CARTRIDGES**

Delivers high quality, safety, reliability and efficiency. Easy to install on your boat for bottled water quality. Kit includes cartridge, wrench, mounting hardware, m/f garden hose fittings and 12" garden hose. With normal usage, cartridges should be changed every 6 months. 1 year warranty.

Item	Model	Description	Ship	Net
500120	RV-10UC-A	10" Filter housing assembly	4 lbs	\$72.99
503199	155002-43	10" Carbon paper cartridge	1 lbs	8.49
503557	155155-43	10" CC-10 Coconut shell cartridge	2 lbs	14.99
503558	255681-43	10" REPLACEMENT 10" CFB-PB10 Lead sorbent carbon block cartridge	1 lbs	21.99
503559	255800-43	10" UDS-10EX1 Filter Cartridge	2 lbs	52.99
503560	255679-43	10" CFBC-10 Filter Cartridge	1 lbs	19.99



**SHURFLO WATERGUARD™ IN-LINE FILTERS**

Easy to install, these filters will rid your water of up to 95% of chlorine and provide gallons of clean drinking water. Self-contained filters are water washed coconut carbon, which increases efficiency and filter life. Filter should be changed every 6 months under normal usage. 1 year warranty.

Item	Model	Description	Ship	Net
500124	RV-210BRB-A	1 1/2" Filter w/ 1/2" barb fitting	2 lbs	\$37.99
500125	RV-210GH-A	1 1/2" Filter w/ garden hose connection	2 lbs	39.99
501470	94-009-50	10" Filter w/ 1/4" and 1/2" fittings	2 lbs	39.99



**SPECTRA WATERMAKERS SURVIVOR WATERMAKERS**

From hand-operated models to larger 12 Volt DC models, Spectra desalinators enable boaters to go farther and longer without fresh water worries. Designed for salt water use in clear blue ocean water when sailing or traveling. Survivor watermakers feature durable construction to military specifications, compact design and energy efficient operation by reverse osmosis. 3 year limited warranty.

**SURVIVOR 06**

Manual pump - no outside power needed. Designed to provide fresh water for emergency use. The Survivor 06 is stored in liferafts or man overboard packs. Approved SOLAS desalting device; USCG approved. 5" H x 8" L x 2.5" W. 40 strokes/minute. Smallest hand-operated emergency desalinator in the world. Produces up to 3-3/4 cups per hour.

Item	Model	Description	Ship	M.A.P.
500000	8013418	Desalinator	4 lbs	\$1195.00



**SURVIVOR 35**

The Survivor 35 is widely used worldwide by military forces, voyagers, sea kayakers and other adventurers. Compact and light enough to carry aboard a sea kayak and ideal for sailors without auxiliary power. 5.5" L x 22" H x 3.5" W. Produces up to 1.2 gallons per hour.

Item	Model	Description	Ship	M.A.P.
502977	8013433	Desalinator	10 lbs	\$2395.00



**POWERSURVIVOR 40E**

Stainless steel pump housing, simplified mechanics and space saving membrane configuration. Drawing only 4 A on 12 Volt DC, the 40E is as efficient as its predecessor, the PowerSurvivor 35, yet produces 14% more water. Convertible to hand operation for emergency use. 6"H x 17.5"L x 16"W. Produces up to 1.5 gallons per hour.

Item	Model	Description	Ship	M.A.P.
500001	8013438	Desalinator	40 lbs	\$4270.00



**SPECTRA VENTURA 150D WATERMAKER**

WITH ANALOG CONTROL PANEL

- 6.3 GPH, Salt Rejection: 99.2%, compatible with Spectra's Z±lon system
- Power / Draw: 12 Volt DC, 9 Amps
- Operates in all water temps, run-dry protection

Item	Model	Description	Ship	M.A.P.
503798	VT-150-D-12V	Desalinator	96 lbs	\$6295.00



**SPECTRA VENTURA 150C WATERMAKER**

WITH DIGITAL CONNECT CONTROL PANEL

- 6.3 GPH, Salt Rejection: 99.2%, compatible with Spectra's Z±lon system
- Power / Draw: 12 Volt DC, 9 Amps
- Operates in all water temps, run-dry protection

Item	Model	Description	Ship	M.A.P.
503799	VT-150-C-12V	Desalinator	96 lbs	\$9320.00



**SPECTRA VENTURA 200T WATERMAKER**

WITH ANALOG CONTROL PANEL

- 8.3 GPH, Salt Rejection: 99.2%, compatible with Spectra's Z±lon system
- Power / Draw: 12 Volt DC, 10 Amps
- Operates in waters from 36° F to 110° F, run-dry protection

Item	Model	Description	Ship	M.A.P.
503800	VT-200-T-12V	Desalinator	96 lbs	\$6795.00



**SPECTRA VENTURA 200C WATERMAKER**

WITH DIGITAL CONNECT CONTROL PANEL

- 8.3 GPH, Salt Rejection: 99.2%, compatible with Spectra's Z±lon system
- Power / Draw: 12 Volt DC, 10 Amps
- Operates in waters from 36° F to 110° F, run-dry protection

Item	Model	Description	Ship	M.A.P.
503801	VT-200-C-T-12V	Desalinator	96 lbs	\$9875.00



**FORESPAR PUREWATER+ WATER FILTER KIT**

- Ideal for space-saving water filtration
- Easy to install and maintain • Attractive solid brass chrome faucet
- Filter cartridge life is up to 350 gallons or three months
- Includes solid brass chrome faucet, filter and hose

Item	Model	Description	Ship	Net
503608	770295	Faucet Kit	2 lbs	144.99
503609	770297-1	5 Micron Replacement Filter	1 lbs	26.99
	770297-2	5 Micron Replacement Filter 2 Pk.	1 lbs	42.99
	770298-1	0.5 Micron Replacement Filter	1 lbs	33.99
	770298-2	0.5 Micron Replacement Filter 2 Pk.	1 lbs	54.99



**AMERICAN PLUMBER COLD WATER FILTER SYSTEMS**

Slim-line housings are designed for easy under sink installation and are ideal for taste-odor filtration. Package is a complete kit which includes all installation hardware. Cartridge not included.

Item	Model	Description	Ship	Net
500907	152007	4-1/2" W x 7" H, 3/8 NPT	2 lbs	\$21.99
500908	155022-52	Replacement cartridges for above	1 lbs	19.99



**VILLAGE MARINE WATERMAKERS - PARTS & ACCESSORIES AVAILABLE!  
PLEASE CALL OR VISIT WWW.DEFENDER.COM FOR MORE INFORMATION!**



**ISOTEMP MARINE SPA WATER HEATERS (POLYPROPYLENE JACKET)**

- Exterior casing/jacket made of high quality polypropylene
- Inner tank made of AISI 316 stainless steel
- Includes safety valve and mixing valve
- Heating element designed to heat water at bottom of tank
- Thermostat-controlled mixing valve standard
- Adjustable aluminum mounting brackets for deck or bulkhead
- Front heat exchanger uses engine heat to heat water to 190+°
- Extra-thick insulation for high performance
- Extra-long corrugated coils for high heat exchange efficiency
- Orientation: horizontal or vertical



5 Year Limited Warranty! (on Tank)

\*5 Year Limited Warranty! (on inner Tank against corrosion and material stress)  
Warranty limited to leakage due to corrosion or manufacturing defect.

**Robust design and manufactured to highest-quality marine standards for long service life.**

MARINE SPA- Specify Power: 115 VAC or 230 VAC							
Item	Model	Gal.	L x Dia.	Tank Material	Exchanger	Ship	Starting At
502707	Spa 15	4	19.3" x 12.7"	Stainless Steel	Front	22 lbs	\$504.99
D 502708	Spa 20	5.3	23.2" x 12.7"	Stainless Steel	Front	28 lbs	529.99
D 502709	Spa 25	6.5	26.8" x 12.7"	Stainless Steel	Front	32 lbs	549.99
D 502710	Spa 30	8	22" x 15.5"	Stainless Steel	Front	38 lbs	554.99
D 502711	Spa 40	11	26" x 15.5"	Stainless Steel	Front	45 lbs	579.99



**ISOTEMP MARINE WATER HEATERS (STAINLESS STEEL JACKET)**

Basic



5 Year Limited Warranty! (on Tank)

\*5 Year Limited Warranty! (on inner Tank against corrosion and material stress)

**Designed for long life in the tough marine environment.**

BASIC - Specify Power: 115 VAC or 230 VAC							
Item	Model	Gal.	L x Dia.	Tank Material	Exchanger	Ship	Starting At
D 502688	Basic 24	6.4	19.3" x 15.5"	Stainless Steel	Front	66 lbs	\$754.99
D 502689	Basic 30	8	21.9" x 15.5"	Stainless Steel	Front	71 lbs	754.99
D 502690	Basic 40	11	26" x 15.5"	Stainless Steel	Front	89 lbs	814.99
D 502692	Basic 50	13	30.7" x 15.5"	Stainless Steel	Front	103 lbs	859.99
D 502693	Basic 75	20	42.2" x 15.5"	Stainless Steel	Front	80 lbs	929.99

Slim Line



Square



- 316 stainless steel tanks resist electrolysis
- Long-life nickel plated copper element
- Pressure release valve allows easy winterization
- Stainless steel mounting brackets
- Front heat exchanger uses engine heat to heat water to 190+°
- Superior insulation keeps water hot for 24 hrs or longer
- Can be mounted horizontally on decks or vertically on bulkheads
- Element heats quickly and keeps excess loads off generators/dock power

SLIM LINE - Specify Power: 115 VAC or 230 VAC							
Item	Model	Gal.	L x Dia.	Tank Material	Exchanger	Ship	Starting At
D 502685	Slim 15	4	21.25" x 11.7"	Stainless Steel	Front	45 lbs	\$654.99
D 502686	Slim 20	5.3	26.2" x 11.7"	Stainless Steel	Front	51 lbs	664.99
D 502687	Slim 25	6.5	30.9" x 11.7"	Stainless Steel	Front	62 lbs	724.99

SQUARE - Specify Power: 115 VAC or 230 VAC							
Item	Model	Gal.	L x W x H	Tank Material	Exchanger	Ship	Starting At
502695	Square 16	4.2	23.25" x 7.25" x 15.75"	Stainless Steel	Front	41 lbs	\$864.99



**KUUMA PREMIUM WATER HEATERS**

- Non-ferrous aluminum alloy outer casings
- Heat exchanger ensures more efficient heat control
- Ignition protected controls
- High pressure valve installed
- ETL approved
- All units: 120 VAC
- Water in/out: 1/2" NPT
- SRV valve: 3/4" NPT
- Larger front heat exchanger with 5/8" hose barb
- High temperature limiter is resettable at panel



Anode - extends water heater life!

**Marine Quality aluminum alloy case and tank.**

Item	Model	W x D x H	Gal.	Tank Material	Exchanger	Ship	Net	
D 501145	11812	13.75" x 19.75" x 13.625"	6	Aluminum	Rear	31 lbs	\$299.99	
D 502573	11810	15.625" x 19.375" x 13.625"	6	Aluminum	Front	31 lbs	299.99	
D 502574	11811	13.75" x 19.75" x 13.625"	6	Aluminum	Front	31 lbs	299.99	
D 502576	11841	16.25" x 23.25" x 16.25"	11	Aluminum	Front	44 lbs	367.99	
D 502575	11840	18.875" x 21.625" x 16.25"	11	Aluminum	Front	49 lbs	367.99	
D 502577	11870	18.875" x 20.75" x 29.75"	20	Aluminum	Front	73 lbs	529.99	
402408	11916	KUUMA anode rod with drain - magnesium, 3/4"-14 NPT x 6" with drain					2 lbs	19.99



**Water Heaters**

**SEAWARD WATER HEATERS**

- 2 year warranty
- UL listed; ignition protected
- UL approved double wall heat exchangers
- Dimpled bottom to prevent water accumulation/corrosion
- Cold water supply and hot water inlet: 1/2" NPT
- 120 VAC circuits require 15 Amp breakers
- T and P drain tube included
- Heat exchanger tubing accepts 5/8" I.D. hose
- 240 VAC circuits require 10 Amp breakers

Made in USA



Stainless steel models also available at [defender.com](http://defender.com)

Item	Gallons	W x D x H	Voltage	Finish	Tank Material	Exchanger	Ship	Starting At
501182	3	14-1/2" x 14" x 13"	120V	Painted aluminum *	Aluminum**	Side	14 lbs	\$382.99
503248	6	13" x 19" x 13"	120 or 240V	Galvanized steel	Aluminum**	Rear	25 lbs	449.99
503249	6	13" x 19" x 13"	120 or 240V	Painted aluminum *	Aluminum**	Rear	18 lbs	499.99
503251	6	13" x 19" x 13"	120 or 240V	Galvanized steel	Aluminum**	Front	25 lbs	444.99
503252	6	13" x 19" x 13"	120 or 240V	Painted aluminum *	Aluminum**	Front	19 lbs	514.99
D 503254	11	16" x 22" x 16"	120 or 240V	Galvanized steel	Aluminum**	Rear	39 lbs	494.99
D 503255	11	16" x 22" x 16"	120V	Painted aluminum *	Aluminum**	Rear	39 lbs	574.99
D 503257	11	16" x 22" x 16"	120 or 240V	Galvanized steel	Aluminum**	Front	39 lbs	499.99
D 503258	11	16" x 22" x 16"	120 or 240V	Painted aluminum *	Aluminum**	Front	39 lbs	554.99
D 503263	20	16" x 32" x 16"	240V	Galvanized steel	Aluminum**	Rear	57 lbs	774.99
D 503264	20	16" x 32" x 16"	240V	Painted aluminum *	Aluminum**	Rear	59 lbs	884.99
D 503266	20	16" x 32" x 16"	120 or 240V	Galvanized steel	Aluminum**	Front	57 lbs	754.99
D 503267	20	16" x 32" x 16"	120 or 240V	Painted aluminum *	Aluminum**	Front	59 lbs	829.99
501274	<b>SEAWARD MAGNESIUM ANODE - Recommended for longer tank life</b>						1 lbs	26.99

\* White epoxy painted aluminum \*\*Alcoa Alclad aluminum alloy



## Glass Lined Water Heaters



### RARITAN GLASS LINED WATER HEATERS

- Efficient insulating foam and glass lined tank
- Impact resistant, flame retardant jacket, cover and base – will never rust
- CFC-free insulation increases efficiency and protects the environment
- Specify 120 VAC or 240 VAC
- 1250 W heating element and ignition protected thermostat
- Meets UL requirements for vibration, shock and ignition protection
- Heat exchanger models allow connection to engine heating system
- All models supplied with WH3 pressure relief valve
- Anode protected



### WITH HEAT EXCHANGERS

Item	Model	Gal.	H x Dia.	Tank Material	Ship	Net
503452	120 VAC or 240 VAC	6	16.25" x 14.5"	Glass lined	41 lbs	\$899.99
D 503454	120 VAC or 240 VAC	12	16.25" x 18.75"	Glass lined	70 lbs	Starting at 954.99
D 503456	120 VAC or 240 VAC	20	24.25" x 18.75"	Glass lined	74 lbs	1024.99

240 Volt AC models are available by special order, ship FOB NJ. Please contact Defender with the manufacturer's part number.

### WITHOUT HEAT EXCHANGERS

Item	Model	Gal.	H x Dia.	Tank Material	Ship	Net
503451	120 VAC or 240 VAC	6	16.25" x 14.5"	Glass lined	34 lbs	\$789.99
503453	120 VAC or 240 VAC	12	16.25" x 18.75"	Glass lined	51 lbs	854.99
D 503455	120 VAC or 240 VAC	20	24.25" x 18.75"	Glass lined	74 lbs	914.99

Item	Model	Description	Ship	Net
500181	WH3	Pressure relief valve, 3/4" inlet, 3/4" outlet	1 lbs	\$39.99
503274	WH16	Water heater thermostat for all Raritan models	1 lbs	86.99

## Water Tanks and Fittings



### VETUS FLEXIBLE DRINKING WATER TANKS

- Can be installed easily, assumes the shape of the space it occupies

Item	Model	Gallons	Size	Ship	Net
501761	TANKW55	14.5	27" x 31"	3 lbs	\$184.99
501759	TANKW70	18.5	31" x 31"	4 lbs	194.99
501760	TANKW100	26.4	31" x 39"	4 lbs	199.99
501762	TANKW160	42.3	31" x 56"	5 lbs	264.99
501763	TANKW220	58.1	29" x 80"	7 lbs	309.99
501764	TANKW1003	26-1/2	46" x 46" x 59" (triangle)	4 lbs	344.99

Fittings included 5/8" outlet and 1-1/2" inlet



### PLASTIMO FLEXIBLE WATER TANKS

- Flexible, lightweight, form-fitting and resists tears
- Inner, removable bladder (welded seams) is non-porous, tasteless PVC inside a tough nylon shell
- Includes a 1.5" inlet fitting and a .5" outlet valve on the underside

Item	Model	Capacity	Size	Ship	Net
500204	18033	100 L	110 cm x 75 cm	6 lbs	\$119.99
500205	16656	150 L	150 cm x 75 cm	6 lbs	139.99
500206	16657	200 L	195 cm x 75 cm	8 lbs	179.99
502978	16658	120 L	120.5 cm x 108 cm (triangle)	6 lbs	139.99
503403	26957	120 L	105 cm x 115 cm (triangle)	4 lbs	119.99

\*Note: when filled to capacity, each tank measures 25 cm (9.8" D) thick



### NAUTA FLEXIBLE WATER/GRAY WASTE TANKS

- Rugged 840-denier nylon fabric, coated with a neoprene nitrile
- Tedlar™ lining to maintain fresh taste
- Vulcanized to assure leakproof panels and seams
- (2) FTP1210 1-1/2" fill fittings, (1) E300 vent and spanner wrench included

Item	Model	Capacity	Size	Ship	Net
501476	FT911121	13 gallon	26.5" x 24.5"	4 lbs	\$239.99
501475	FT911157	23.5 gallon	26.5" x 33.5"	6 lbs	279.99
500223	FT911167	35.5 gallon	26.5" x 45.5"	7 lbs	324.99
501279	FT911187	52.5 gallon	26.5" x 62.5"	9 lbs	414.99

### WATER TREATMENT

#### CAMCO TASTEPURE SPRING FRESH

- Fresh water systems cleaner and deodorizer
- Treats up to 100 gallons

Item	Model	Size	Ship	Net
G 756197	40207	Gallon	9 lbs	\$15.99

#### CAMCO FRESH WATER DEWINTERIZER AND REVITALIZER

- For fresh water plastic tanks and lines
- Treats up to 60 gallons

Item	Model	Size	Ship	Net
G 754223	40218	16 oz	2 lbs	\$15.49

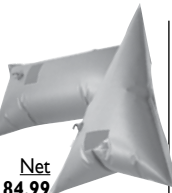

16657

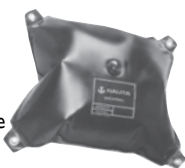

Meets USCG standards!

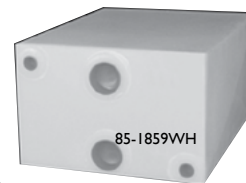

85-1859WH

### TODD WATER TANKS

Made of polyethylene that complies with FDA regulations

- All openings are female NPT and standard adaptable sizes

Item	Model	Size	Dimensions (L x W x H)	Ship	Net
503126	85-1859WH	3 gallon	14" x 11" x 6.5"	6 lbs	\$67.99
503127	85-1531WH	6 gallon	16" x 12" x 8"	7 lbs	83.99
503128	85-1667WH	9 gallon	17" x 14" x 10"	11 lbs	99.99
503129	85-1626WH	13 gallon	24" x 10" x 14"	15 lbs	114.99
D 503130	94-1627WH	15 gallon	25" x 11" x 15"	31 lbs	120.99
D 503131	85-1666WH	20 gallon	30" x 16" x 10"	35 lbs	135.99
D 503132	85-1532WH	25 gallon	37" x 17.5" x 10"	45 lbs	162.99
D 503133	85-1525WH	35 gallon	36" x 15.5" x 16"	52 lbs	188.99
D 503134	85-1533WH	55 gallon	54.5" x 13" x 20"	100 lbs	251.99
501222	93-2220	Straight pipe to hose fitting		1 lbs	24.99
501265	93-2221	90° Pipe to hose fitting		1 lbs	31.99
500220	90-2218	Water tank fitting relocation kit		1 lbs	47.99

Note: fittings are not included in the price of the tanks

### SCEPTER POTABLE WATER TANK

- High-density polyethylene
- Lightweight, UV protected
- 5 gallons. Color: Blue

Item	Model	Dimensions	Ship	Net
502615	04933	13" x 7" x 18.25"	3 lbs	\$21.99



### AMBASSADOR STAINLESS STEEL WATER INLET/OUTLET

Item	Model	Description	Net
502875	P56-0190-SS	Inlet, 3/4"NH-F x 1/2"NPS-F	\$38.99
502876	P56-0200-SS	Outlet, 3/4"NH-M x 1/2"NPS-F	30.99



### SHURFLO WATER INLET PRESSURE REGULATOR

Combination water regulator, entry screen and check valve.

Item	Model	Description	Ship	Net
500754	183-029-14	Chromed plastic	1 lbs	\$39.99
503390	183-029-18	Gel White	1 lbs	31.99

Jabscow water pressure regulators available at [www.defender.com](http://www.defender.com)

### STAR BRITE WATER TREATMENT & FRESHENER

- Maintains perfect drinking water quality
- 1 fluid oz. treats 20 gallons

Item	Model	Size	Ship	Net
G 756323	97016	16 oz.	2 lbs	\$12.99
G 756324	97008	8 oz.	1 lbs	7.99



### SUDBURY AQUA FRESH™

- Safe, nontoxic, biodegradable – for fresh odor free water

Item	Model	Size	Ship	Net
G 755682	830	(8) 2 oz. packets	2 lbs	\$10.99



## Interior Showers

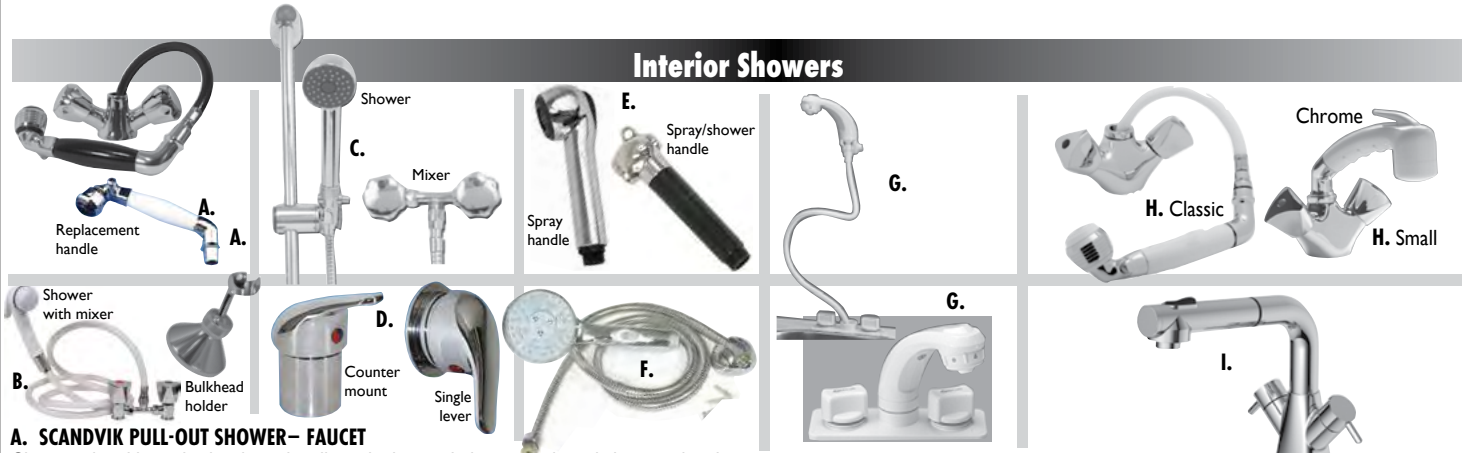

### A. SCANDVIK PULL-OUT SHOWER- FAUCET

Chrome plated brass body, plastic handle with chromed plastic nozzle and chrome plated brass elbow. Adjustable spray head with water-saver valve; 5' hose; 1/2" NPS-F.

Item	Model	Description	Ship	Net
501159	46011	White pull-out shower-faucet	4 lbs	\$179.99
501160	46012	Black pull-out shower-faucet	4 lbs	179.99
502264	10650	Bulkhead swivel shower handle holder	1 lbs	22.99
990049	10777	White replacement shower mixer/sprayer handle	1 lbs	119.99

### B. SCANDVIK SHOWER KIT

Chrome plated brass body. Chrome plated ABS triangle knobs with white ABS plastic Euro-sprayer. White Euro-sprayer has On/Off trigger which locks in both "on" and "off" positions; 6' matching hose; 1/2" NPT-M.

Item	Model	Description	Ship	Net
502571	14117	Shower kit, White handle	2 lbs	\$100.99
500044	10013	Bulkhead holder - for straight shower handles	1 lbs	25.99

### C. SCANDVIK AQUA FINA SHOWER KIT

Chrome plated brass mixer and rail with chromed plastic handle. Includes bulkhead mount mixing bridge and in-line water conservation valve located between handle and hose.

Item	Model	Description	Ship	Net
990051	14140	Easy up/down adjustments - Standard knob	5 lbs	\$147.99

### D. SCANDVIK SHOWER CONTROLS-CHROME PLATED BRASS

Counter mount or an extended reach bulkhead mount shower mixer. Adapters included.

Item	Model	Description	Ship	Net
501150	10466	1/2" NPS-F supply connections; 3/8" BSP-M output for Scandvik shower hoses.	2 lbs	\$108.99

Single lever shower mixer with compact trim ring. Also includes (3) 1/2" hose barb fittings

Item	Model	Description	Ship	Net
503177	10479	1/2" NPS-F for input and output	2 lbs	\$108.99

### E. SCANDVIK REPLACEMENT HANDLES

Material: Chromed plastic, Thread type: 1/2" NPS-M  
Designed for models 10626, 10880 and 10871

Item	Model	Description	Ship	Net
503338	14023	Replacement spray handle	1 lbs	\$38.99

For Scandvik recessed showers. **Please specify:** Black or White

Item	Model	Description	Ship	Net
501144	10297/10283	Replacement spray/shower handle	1 lbs	47.99

### F. CAMCO MARINE/RV SHOWER HEAD KIT

Includes handheld showerhead with On/Off switch. Heavy-duty construction. Chrome-plated finish.

Item	Model	Description	Ship	Net
502593	43713	2.5 GPM with 40 PSI and 1.7 GPM with 25 PSI	2 lbs	\$28.99

### G. WHALE ELEGANCE MIXER COMBINATION FAUCET/SHOWER

Handset with shower, tap and On/Off function control. Use in the wash basin or as a shower by fitting a wall bracket or riser bar (Sold separately). Water flow can be temporarily shut off on shower head, maintaining temperature control. Retracting hose. Base plate: 6-3/4" x 2-7/16".

Item	Model	Description	Ship	Net
502411	RT2498	White	2 lbs	\$134.99

### Replacement Elegance Mk2 Handset

500328	AS5133	White; 1/2" BSP (For models after 1996)	1 lbs	64.99
--------	--------	-----------------------------------------	-------	-------

### H. AMBASSADOR\* TRINIDAD™ SHOWER/FAUCET COMBO - Classic Sprayer

Chrome-plated, solid brass body with locking teeth. Classic sprayers have 2-setting spray/stream with pause. Ceramic disc valves. Connections: 1/2" NPS-M. 5 year warranty.

Item	Model	Description	Ship	Net
502909	135-0204-CW	Chrome and White rubber	5 lbs	\$179.99
	134-0204-CK	Chrome and Black rubber	5 lbs	179.99
502612	131-0212-CP	Sprayer holder, Chrome, plastic	1 lbs	9.99

### TRINIDAD™ - Small Trigger Sprayer- 2-setting spray/stream with pause

502872	134-0213-CW	White and Chrome finish	5 lbs	\$164.99
502873	134-0213-CP	Chrome finish	5 lbs	174.99

### I. AMBASSADOR\* AIDACK™ HEAD/SHOWER COMBO FAUCET

2-setting spray/stream pull-out sprayer. High arc swivel spout. Quick-connect pull-out hose adapter. Solid brass body. Ceramic disc valve system. Connections: 1/2" NPS-M.

Item	Model	Description	Ship	Net
502862	135-1737-CP	Chrome finish; Stainless steel hose	5 lbs	\$159.99

\* Formerly SHURflo

## Sump Pumps



### A. JABSCO SELF-PRIMING SHOWER DRAIN AND BILGE PUMP

- 12 VDC • Dry running capability • With Pumpgard strainer
- Permanent magnet motor • Permanent magnet type motor
- Meets ISO 8846 Marine ignition protection

Item	Model	GPM	Port Size	Draw	Fuse	Ship	Net
502336	37202-2012	3	3/4"	8 A	10 A	5 lbs	\$272.99

### B. JABSCO SELF-PRIMING SHOWER DRAIN AND BILGE PUMP

- 12 VDC • Flexible installation • Dry running capability
- Robust, single diaphragm design; no filter required
- Permanent magnet type motor
- Meets ISO 8846 marine and USCG regulations for ignition protection

Item	Model	GPM	Port Size	Draw	Fuse	Ship	Net
500323	50880-1000	4.2	3/4"	8 A	10 A	7 lbs	\$227.99

### C. FLOJET 4105 SERIES SHOWER DRAIN PUMP

- 12 VDC • Self-priming • Dry running capability
- 4-chamber diaphragm positive displacement design
- Meets USCG requirements for ignition protection

Item	Model	GPM	Port Size	Draw	Fuse	Ship	Net
500670	04105-143A	3.3	1/2"	4 A	10 A	5 lbs	\$131.99

### D. RULE AUTOMATIC SUMP UTILITY PUMP

- Completely submersible (fresh/salt water), high capacity, energy efficient
- Computerized automation eliminates need for float switch
- Auto start in 1" of water; auto shut-off prevents dry running or jamming
- Double insulated motor, heavy duty protective housing and snap-off strainer

Item	Model	Description	Hose I.D.	Ship	Net
500649	A53S	1800 GPH, 110 VAC, 8' cord	1-1/8"	5 lbs	\$144.99

### E. JOHNSON MULTI-PORT SHOWER SUMP WITH ULTIMA SWITCH

Inlet #1- use with 3/4" hose, Inlet #2 - use with 3/4" or 1" hose , Inlet #3 can be used with 1-1/8" or 1-1/2" hose Discharge hose: 3/4"

Item	VDC	GPH	Max Current	Fuse	Ship	Net
503242	12	844	3.4A	5A	3 lbs	\$106.41
	24	844	2A	3A	3 lbs	117.99

### F. RULE SHOWER BOX

- Scoop strainer allows you to easily get your hand under the strainer to clean the debris from the box
- Several port fittings including 3/4", 1", 1 1/8", straight and 90° elbow fittings plus 3/4" and 1" straight and elbow Flow-Rite fittings

Item	Model	VDC/Amps	L x W x H	Ship	Net
503820	98B	12/2.9	9" x 9.5" x 5"	4 lbs	\$129.99

### G. WHALE GW0500 SHOWER SUMP SYSTEM

- Includes a sump box, compact and powerful Orca pump, automatic electric field sensor and robust stainless steel filter all pre-assembled

Item	VDC	GPH	Port Size	Ship	Net
502082	12	500	3/4" to 1-1/2"	4 lbs	\$144.99

### H. WHALE GULLEY IC PUMP KIT

- Includes Gulper® IC pump, small Gulley® IC single shower drain and cable
- IC sensor recognizes when water is no longer present

Item	VDC	Hose Size	Ship	Net
501709	12 or 24	3/4" and 1"	5 lbs	\$264.99

### I. WHALE GRAY WATER IC PUMP KIT

- High capacity multiple drain Gray waste management system
- Includes two-way manifold IC with intelligent control
- Drains multiple sources of water • Easy-to-install; self-priming; runs dry
- Automatic control - receives electrical signals to turn on/off

Item	VDC	GPH	Hose Size	Ship	Starting at
501713	12 or 24	300	3/4" and 1"	6 lbs	\$284.99

### J. WHALE GULPER 220/320 PUMPS

- Shower/waste pumps use a single diaphragm and in-line intake and outlet
- Allows free flow of debris and handles a mixture of air and water
- Quiet running and self-priming

Item	Model	VDC	Hose	GPM	Amps	Ship	Net
503200	BP1552	12	3/4" only for inlet and 1"	3.7	5	4 lbs	\$174.99
	BP1554	24	3/4" only for inlet and 1"	3.7	2.5	4 lbs	179.99
502510	BP2052	12	3/4" and 1"	5	7.5	5 lbs	194.99
	BP2054	24	3/4" and 1"	5	3.25	5 lbs	199.99
501712	AK2050		Gulper 220,320 pump service kit			1 lbs	20.99



## Exterior and Deck/Transom Showers



### SCANDVIK RECESSED HOT/COLD TRANSOM SHOWERS

- All house high quality mixers and sprayers
- Use in vertical or horizontal installations
- Friction hinges with single or double latches
- Friction will hold cap up and out of the way

### 316 STAINLESS STEEL COVER

Item	Model	Description	Ship	Net
A.	503179 12141	Double cup; chromed brass ceramic mixing valve; push-button handle; 1/2" NPS-F, 6' White hose	3 lbs	\$144.99
	503180 12142	Double cup; chromed brass ceramic mixing valve; Euro handle; 1/2" NPS-F, 6' White hose and sprayer	3 lbs	160.99
B.	503181 12134	Single cup; chromed brass ceramic valve mixer; 1/2" NPS-F, 3/8" BSP-M shower hose connection	2 lbs	121.99
C.	503182 12131	Single cup; chrome plated brass and white plastic; push-button handle and 6' White hose; 3/8" BSP-F*	2 lbs	79.99

### WHITE PLASTIC COVER

Item	Model	Description	Ship	Net
D.	502366 10750	Single cup with snap-in soft cap; chrome-plated brass push-button sprayer, 3/8" BSP-F fitting*, 6' White nylon hose, vertical mount only with a 2-1/4" hole	2 lbs	\$67.99
E.	503084 12109	Double cup; chromed brass ceramic mixing valve; 6' White nylon hose; White push-button handle; 1/2" NPS-F	3 lbs	119.99
F.	503185 12110	Double cup; chromed brass mixing valve; 6' White nylon hose; White Euro handle; 1/2" NPS-F	3 lbs	128.99
G.	503184 12108	Single cup; chromed brass ceramic mixing valve; use with push-button or trigger handle; 1/2" NPS-F supply, 3/8" BSP-M hose connection	2 lbs	108.99
H.	502359 10055	Single cup with snap-in soft cap; chrome-plated brass push-button sprayer, 6' White nylon hose, 3/8" BSP-F fitting* horizontal mount only with 2-1/4" hole	2 lbs	70.99
I.	503086 12106	Single cup with friction lock cap; push-button sprayer; 6' White nylon hose, 3/8" BSP-F* horizontal or vertical mount with 2-3/4" hole	2 lbs	69.99
J.	503186 12140	Single cup; White Euro handle; 5' stainless steel hose; 1/2" NPS-F female connection	2 lbs	49.99
	501527 12104	Replacement cup & cap set	1 lbs	20.99

Black also available by special order.

\* Includes 1/2" NPT-M adapter

### K. SCANDVIK HOT/COLD EXTERIOR SHOWER BOX

- White ABS plastic housing and sprayer handle
- 6' White hose
- Cutout: 8-5/8" W x 6-1/2" H x 4" D
- Chromed brass mixer
- Box: 10-7/8" W x 8-3/4" H x 4" D

Item	Model	Description	Ship	Net
502572	10640	3/8" BSP (threaded shaft) connection with 1/2" NPS-M nylon adapters included	4 lbs	\$185.99

Many spare parts and other Scandvik models available at [defender.com](http://defender.com)

### L. ATTWOOD AFT DECK HOT/COLD SHOWER

- Handheld shower spray head, 6' hose, hot and cold controls, in a hinged covered unit
- Horizontal box: 9-1/2" L x 5" W x 2-1/4" D • Cutout: 8-1/2" x 3-7/8"

Item	Model	Ship	Net
501063	4131-4	3 lbs	\$124.99

### M. AMBASSADOR RECESSED TRANSOM SHOWER - 5 year warranty

- Continuous spray function
- 6' heavy duty hose
- Features 1/2" NPS-F thread
- Deck or wall mount installation

Item	Model	Description	Ship	Net
502607	137-0000-WH	White cup and matching sprayer	2 lbs	\$62.99

### N. AMBASSADOR TRINIDAD 2 HANDLE TRANSOM SHOWER

- Hot and cold mixer • Cutout: 7-7/8" x 4-7/8"
- Flush mount, White, ABS plastic box
- Solid brass and copper body with ceramic disc valve system
- 6' retractable, heavy duty White rubber hose • 1/2" NPS-M connections

Item	Model	Description	Ship	Net
502602	137-0203-CW	Recessed compartment with (2) handles	5 lbs	\$189.99



### O. AMBASSADOR SMALL DECK SPRAYER

- Handheld • 6' White rubber hose • White ABS sprayer
- 1/2" NPS-F • Single temperature
- Includes chrome plated, solid brass deck-mounted holder

Item	Model	Description	Ship	Net
502608	135-0011-WH	Sprayer	5 lbs	\$47.99
502874	137-0004-WH	Trinidad shutoff valve	2 lbs	72.99

### P. WHALE TWIST™ HOT/COLD DECK WATER SHOWER

- Requires only one circular hole and simple plumbing connection • Pull-out design
- Integrated handset: incorporates temperature and flow controls
- Rubberized end cap with 8.2" hose
- Angled (plastic) and straight (chrome-plated plastic) mounting brackets included

Item	Model	Description	Ship	Net
503148	DS0005	Cold, Gray/White	3 lbs	\$118.99
503149	DS0006	Hot and cold, Gray/White	4 lbs	144.99

### Q. OSCULATI ADRIANA RECESSED SHOWER WITH MIXER

- Material: White plastic and chrome-plated brass sprayer and mixing valve
- Connection: 1/2" hose end connects directly to 1/2" handset
- Hose: 4 m stainless steel • Cutout: 132 mm x 271 mm

Item	Model	Mount	Ship	Net
503792	1548000	Horizontal	4 lbs	\$144.99

### R. OSCULATI DOCCIA CLASSIC EVO TURBO RECESSED SHOWER - COLD ONLY

- Material: White plastic and chrome-plated brass sprayer, stainless steel cover
- Connection: 1/2" hose end connects directly to 1/2" handset
- Hose: 4 m PVC • Cutout: 70 mm diameter

Item	Model	Mount	Ship	Net
503793	1525071	Horizontal	3 lbs	\$42.99
503794	1525074	Vertical	3 lbs	42.99

## Portable Showers

### S. UST MARINE SOLAR SHOWER

- Capacity: 5 gallon • Color: Black
- Heats water with full sun exposure
- Includes On/Off flow control shower head

Item	Model	Ship	Net
503582	20-02047-01	1 lbs	\$8.99

### T. STEARNS OUTDOOR SUN SHOWER

- Polished, ultra clear vinyl, ABS plastic nozzle on hose; double-welded seams
- Exclusive liquid crystal temperature indicator
- Uses about 1-1/2 gallons per shower

Item	Model	Size	Ship	Net
502994	2000005826	4 gallon	2 lbs	\$26.99

### U. PLASTIMO SOLAR SHOWER

- Three hours of exposure to the sun heats the water
- Capacity: 5 gallons (19 liters)
- Lightweight: easy to use, carry and hang

Item	Model	Size	Ship	Net
501319	13272	5 gallon (19 liters)	1 lbs	\$24.99



## Galley, Spout & Basin Faucets

### SCANDVIK SWIVEL SPOUT GALLEY MIXER

- Pull out sprayer and 5' chrome flex hose included
- Chrome plated brass faucet body • 1-1/2" mount hole
- Flexible supply lines with 1/2" NPS-F fittings
- Push button spray pattern adjustment with chrome plastic sprayer handle • Height: 9"

Item	Model	Ship	Net
500318	10871	5 lbs	\$262.99

### SCANDVIK COMPACT GALLEY FAUCET WITH PULL-OUT SPRAYER

- Chrome-plated brass body and ABS plastic handle
- Flexible supply lines with 1/2" NPS-F fittings • Non-swivel
- Max. height: 6" • Hose: 5' Chrome flex • Cutout: 1-1/2" dia.

Item	Model	Ship	Net
500309	10880	4lbs	\$149.99

### SCANDVIK SMALL GALLEY/BASIN

- Chrome plated brass single lever faucet
- Mounting hole: 1-1/4" • Swivel spout
- Flexible supply lines with 1/2" NPS-F fittings

Item	Model	Ship	Net
501412	10480	2 lbs	\$123.99

### SCANDVIK SINGLE-LEVER GALLEY MIXER WITH J SPOUT

- Chrome-plated brass • Max. height: 12" Cutout: 1-1/2" dia.
- Flexible supply lines with 1/2" NPS-F fittings

Item	Model	Ship	Net
501155	70104	6 lbs	\$239.99

### SCANDVIK CLASSIC GALLEY FAUCET

- Chrome-plated brass with 1/4 turn ceramic valves
- Flexible supply lines with 1/2" NPS-F fittings
- Swivel J spout • 8-5/8" H • 1-3/8" Mounting hole

Item	Model	Ship	Net
503077	70002	4 lbs	\$129.99

### SCANDVIK MIXER FAUCET

- Chrome-plated brass with swivel spout • 7-1/4" H
- Flexible supply lines with 1/2" NPS-F fittings
- 1" Mounting hole • 1/4 turn ceramic valve

Item	Model	Ship	Net
502368	10422	3 lbs	\$120.99

### SCANDVIK COLD WATER TAP WITH J SPOUT

- Chrome-plated brass body and spout; Chromed brass knob • Connection: 1/2" NPS-M threaded shaft
- Max. height: 10" • Cutout: 7/8" dia.

Item	Model	Ship	Net
502363	10172	2 lbs	\$65.99

### SCANDVIK GALLEY MIXER WITH HIGH-REACH SWIVEL SPOUT

- Chrome-plated brass • 1/4 turn ceramic valve
- Connection: Flexible supply lines with 1/2" NPS-F fittings
- Max. height: 9-1/4" • Cutout: 1" dia.

Item	Model	Ship	Net
502265	10438	1 lbs	\$132.99

### AMBASSADOR STASIS MINI PULL-OUT GALLEY FAUCET

- Spray and stream settings with lock-on spray mode
- 4' Stainless steel pull-out hose • Cutout: 1-1/4"-1-3/8"
- Swivel spout • Ceramic disc valve system
- Connections: 1/2" NPS-M; chrome

Item	Model	Ship	Net
502865	133-0112-CP	5 lbs	\$159.99

### AMBASSADOR PACIFICA PULL OUT GALLEY FAUCET

- Ceramic disc valve system with pull-out spray head
- 1/2" NPT-M • Single lever; hot and cold
- Polished chrome • Cutout: 1-1/4" - 1-1/2"

Item	Model	Ship	Net
502610	132-0003-CP	4 lbs	\$179.99

### AMBASSADOR TRINIDAD HIGH ARC GALLEY/WET BAR FAUCET

- Polished chrome, solid brass body w/ceramic disc valve system
- 10-1/2" high swivel goose neck spout
- Thread 1/2" NPS-M • 6-3/8" W

Item	Model	Ship	Net
502604	133-0202-CP	4 lbs	\$150.99

### WHALE TELESCOPIC SPOUTS All ship 1 lbs

- Suitable for 3/8" and 1/2" hose connection • 360° rotation
- Designed for non-pressurized water systems

Item	Model	Description	Net
500944	FT1152	Telescopic; 5" vertical	\$31.99
500945	FT1160	As above with On/Off	42.99

### WHITECAP BAR FAUCET

- Chrome-plated brass with clear acrylic handles • Flexible supply lines with 1/2" fittings • Dimensions (Base): 5-7/8" x 1-15/16", 4" centerset

Item	Model	Ship	Net
503109	P-4068-A	2 lbs	\$39.99

### IMTRA FYNSPRAY CHROMED BRASS SPOUT

- Rugged construction; swivels out of way; 4-3/4" max. height above counter; 1/2" hose. • Please specify: Brass or chrome

Item	Model	Ship	Starting at
500939	Brass or chrome	1 lbs	\$54.99

## Folding Faucets

Angled

### AMBASSADOR AIDACK™ ELITE FOLDING FAUCET

- Cold only
- Swivel spout
- Solid brass body
- Ceramic disc valve
- Connection: 1/2" NPS-M
- Chrome finish

Item	Model	Style	Ship	Net
502863	132-1739-CP	Angled	2 lbs	\$72.99
502864	132-1729-CP	Arc	2 lbs	64.99

### AMBASSADOR TRINIDAD ELITE FOLDING TAP

- Folds out of the way when not in use
- Solid brass body; chrome finish
- Connection: 1/2" NPS-M
- Cold only
- Swivel spout
- Ceramic disc valve

Item	Model	Ship	Net
502611	133-0209-CP	3 lbs	\$94.99

### AMBASSADOR TRINIDAD FOLDING TAP FAUCET SPOUT

- Folds out of the way when not in use
- Solid brass body; chrome finish
- Connection: 1/2" NPS-M
- Cold only
- Swivel spout
- Compression valve

Item	Model	Ship	Net
502609	133-0208-CP	1 lbs	\$44.99

### SCANDVIK COMPACT FOLD-DOWN FAUCET WITH SINGLE-LEVER CONTROL

- Connection: Flexible supply lines with 1/2" NPS-F fittings
- Max. Height: 8-3/8"; Cutout: 1" dia.

Item	Model	Ship	Net
014400	14400	2 lbs	\$179.99

## Basin Faucets & Washdown Spigots

All Scandvik faucets and taps are 100% lead free chrome plated brass with ceramic valves.

### SCANDVIK CLASSIC BASIN MIXER FAUCET

- Flexible supply lines with 1/2" NPS-F fittings
- Max. Height: 4-1/2", (2) 1/2" holes; (2) 1/4" holes. Pattern available.

Item	Model	Ship	Net
503075	70001	5 lbs	\$117.99

### SCANDVIK HEAVY-DUTY CAST BASIN MIXER FAUCET

- Flexible supply lines with 1/2" NPS-F fittings
- Height: 5" • Mounting hole: 1-1/2"(without drain)

Item	Model	Ship	Net
501151	10485	3 lbs	\$159.99

### SCANDVIK STANDARD FAUCET

- Flexible supply lines with 1/2" NPS-F fittings
- 1" mounting hole • Height: 4-1/2" • Width: 5-1/4"

Item	Model	Ship	Net
502266	10410	3lbs	\$135.99

### SCANDVIK NORDIC SINGLE LEVER BASIN MIXER FAUCET

- Mounting hole: 1-3/8" • Height: 5-7/8"
- Flexible supply lines with 1/2" NPS-F fittings

Item	Model	Ship	Net
501154	70103	5 lbs	\$190.99

### SCANDVIK HEAVY-DUTY COLD WATER BASIN TAP

- Chrome-plated brass body and chromed brass knob
- Connection: 1/2" NPS-M threaded shaft
- Max. height: 2-3/4" • Cutout: 7/8" dia.

Item	Model	Ship	Net
502364	10050	2 lbs	\$71.99

### AMBASSADOR TRINIDAD HEAD FAUCET

- Marine polished chrome • Ceramic disc valve system
- 4-3/8" high • Connections: 1/2" NPT-M

Item	Model	Ship	Net
502605	133-0207-CP	4 lbs	\$154.99

### WHALE ELEGANCE FAUCET WITH SWIVEL SPOUT

- Cold only • Material: ABS plastic body
- Max. height: 4-3/4" • Base dimensions: 4-7/16" x 2-1/8"
- Connection: 1/2" NPT-M / 15 mm Whale Quick Connect

Item	Model	Ship	Net
501005	RT1210	1 lbs	\$64.99

### AMBASSADOR TRINIDAD WASHDOWN SPIGOT

- Polished stainless steel
- Compression valve and garden hose hook up
- Connection: 1/2" NPS-M supply and 3/4" NH-M hose bib

Item	Model	Ship	Net
502606	133-0216-SS	2 lbs	\$99.99

### SCANDVIK ANGLED WASHDOWN SPIGOT

- 316 stainless steel with ceramic valve • Flange Dia.: 2-3/8"
- Outlet: Standard 3/4" garden hose thread
- "Fresh" and "Raw" indicator buttons

Item	Model	Connection	Ship	Net
503395	10175	1/2" NPT-Female	1 lbs	\$79.99

### SCANDVIK WASHDOWN SPIGOT

- 316 stainless steel • Compression style valve
- Garden hose fitting • 7/8" max. bulkhead • Mounting hole: 1"

Item	Model	Connection	Ship	Net
502267	10187	1/2" NPS-M	1 lbs	\$89.99



# Sinks, Drains & Hand/Foot Pumps

## AMBASSADOR MIRROR FINISH STAINLESS STEEL SINKS

Most Ambassador stainless steel sinks work with over or under mount installations. All sinks are made from heavy gauge 304 stainless steel and feature our exclusive Sound KOTE – Noise Reduction Technology.

Item	Model	Fits Drain	Size (Outside of Flange)	Overall Depth	Ship	Net
<b>Rectangle*</b>						
502841	S44-1831-UM-R	2"	14" x 13-1/4"	8-1/8"	8 lbs	\$229.99
502842	S44-4914-UM	2"	14-1/2" x 14-1/2"	9-3/4"	8 lbs	339.99
<b>Double Rectangle*</b>						
502843	S54-1823-UM	2"	23-1/4" x 13-1/4"	8-1/8"	9 lbs	\$364.99
502844	S54-1123-UM	2"	23-1/4" x 13-1/4"	10-1/8"	30 lbs	514.99
<b>Oval</b>						
502845	S64-6530-UM	1-1/2"	13-1/4" x 10-1/2"	5-1/4"	3 lbs	\$92.99
502846	S64-1515-UM-R	2"	15-1/2" x 11"	5-1/4"	4 lbs	186.99
<b>Half Sphere</b>						
502836	S24-1400-UM-R	2"	11-1/2"	4-3/4"	3 lbs	109.99
502837	S24-1501-UM	2"	13-1/4"	5-7/8"	4 lbs	167.99
<b>Cylinder*</b>						
502838	S14-2700-UM-R	2"	11-1/2"	7-1/2"	6 lbs	\$184.99
502839	S14-2701-UM-R	2"	13-3/8"	7-1/2"	6 lbs	199.99
502840	S14-2806-UM	2"	18"	8-1/2"	9 lbs	249.99

\* Offset drain shown – actual drain is centered.



See [www.defender.com](http://www.defender.com) for a more extensive selection of Ambassador and Scandvik products.

## SCANDVIK 18/10 STAINLESS STEEL SINKS

Item	Model/Finish	Size (outside of flange)	Depth	Drain	Ship	Net
<b>Square</b>						
501137	10219 Mirror	14-1/4"	9-3/4"	2-1/16"	7 lbs	\$349.99
<b>Center Drain Single Rectangle</b>						
502253	10214 Mirror	9-7/8" x 12-3/4"	6"	2-1/16"	5 lbs	\$279.99
502254	10215 Mirror	9-7/8" x 12-3/4"	8"	2-1/16"	6 lbs	299.99
<b>Double Below Counter Mount- Drop ships only</b>						
502255	10239 Mirror	15" x 24-3/4"	8"	2-1/16"	14 lbs	\$720.99
<b>Oval</b>						
501224	10280 Polished	10-1/2" x 13-1/4"	5"	2"	3 lbs	\$84.99
990043	10211 Mirror	10-3/8" x 15"	5"	2-1/16"	4 lbs	199.99
<b>Round</b>						
500313	10923 Mirror	9"	4"	2-1/16"	2 lbs	\$84.99
502256	10201 Mirror	11-5/8"	5"	2-1/16"	3 lbs	114.99
502257	10203 Mirror	13-3/16"	6"	2-1/16"	4 lbs	119.99

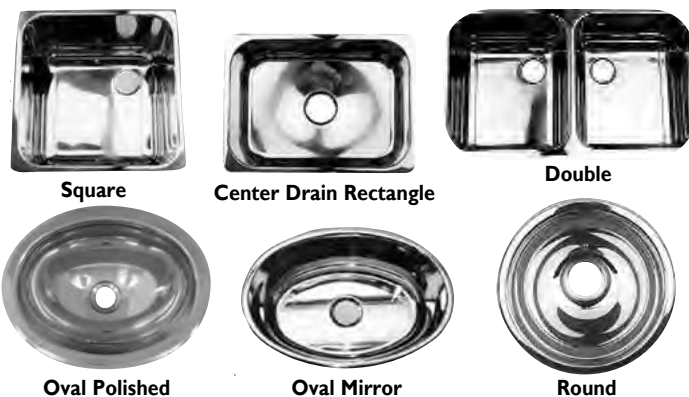

## SINK WASTES AND DRAINS

AMBASSADOR SINK DRAIN KITS All ship 1 lbs.

Item	Description	Net
502847	95°, low profile, 1-1/2", 1" hose barb, with chain stopper	\$21.99
502848	95°, low profile, 2", 1" hose barb, with chain stopper	23.99
502849	Straight; low profile, 1-1/2", 1-1/4" Male thread, with chain stopper	21.99
502850	Straight; low profile, 2", 1-1/4" Male thread, with chain stopper	25.99
502851	Flip trap, low profile, 3/4" and 1" hose barb, no overflow 1-1/2" drain size	58.99

Note:  
1-1/2" drains – For use with sinks that have a 1-5/8" drain opening  
2" drains – For use with sinks that have a 2-1/16" drain opening

SCANDVIK SINK DRAINS All ship 1 lbs.  
Made from stainless steel and PVC for 2-1/16" sink drain holes. Unless noted, all come with stopper.

Item	Description	Net
502259	95° bend, 2-1/16" hole, single, for 1" hose, stainless steel and PVC	\$22.99
502260	Straight, 2-1/16" hole, single, 1-1/4" straight pipe thread	18.99
502379	1-1/2"; fits 2-1/16" hole, drain outlet and stopper	20.99
501140	1-1/2", 2-1/16" hole, double, complete kit with removable baskets	69.99
502262	Shower/cockpit, 2-1/16" hole for 1" hose, does not include stopper	20.99

FORESPAR SINK WASTES All ship 1 lbs.

Item	Description	Net
500969	90°, PVC for 1" hose, 1-3/4" flange, 1-5/16" cutout flange, 1-5/16" cutout	\$10.99
501267	90°, chrome-plated plastic, 2-7/8" flange 2" cutout, barb for 1" ID hose	28.99
500971	Straight barb, 1" ID, chrome-plated plastic, 2-7/8" flange, 2" cutout	26.99
500972	Straight barb, 3/4" ID, chrome-plated plastic, 2-7/8" flange, 2" cutout	25.99
501266	Straight, chrome-plated plastic, 1-1/2" Male thread, 2-7/8" flange, 2" cutout	17.99
500968	Straight, PVC for 1" I.D. hose, 1-3/4" flange, 1-5/16" cutout	8.49
500970	Straight, PVC, for 3/4" I.D. hose, 1-3/4" flange, 1-5/16" cutout	8.49



## FOOT AND HAND PUMPS

### WHALE GUSHER GALLEY MK 3 FOOTPUMP

- Pumps 4 GPM • Operates dry • Self priming
- Multi-directional inlet and outlet port connect to 1/2" flexible tubing or 15 mm, quick-connect plumbing

Please specify: Left or Right discharge

Item	Model/Description	Ship	Net
501263	Hands-free pump	2 lbs	\$104.99
500974	AK0553 Service kit	1 lbs	27.99

### WHALE BABYFOOT PUMP

- Compact, low-cost, single acting
- 1/2" hose • 2.2 GPM

Item	Model/Description	Ship	Net
500975	GP4618 Self-priming pump	1 lbs	\$48.99

### WHALE FLIPPER PUMP MK 4

- 1/2" hose • Self-priming • 60° Swivel
- 1.85 GPM • 7-1/8" above counter
- Kit fits Mk 3 and Mk 4

Item	Model/Description	Ship	Net
500940	GP0418 Faucet	1 lbs	\$82.99
500941	AK0405 Service kit	1 lbs	26.99

### WHALE V PUMP MK 6

- Self-priming to 10' • Fresh water
- 1/2" hose • 2.2 GPM
- Narrow mounting base and an adjustable height from 3-1/2" to 15-5/16"

Item	Model/Description	Ship	Net
500946	GP0650 Pump	1 lbs	\$72.99
500947	AK0618 Service kit	1 lbs	14.99

### FYNSPRAY LEVER GALLEY PUMP

- 46 strokes per gallon • 1/2-3/4" hose
- 11-3/4" maximum height above counter
- 1-5/8" diameter

Item	Model/Description	Ship	Net
500935	WS-62B Brass	4 lbs	\$309.99
500936	WS-62C Chrome	4 lbs	344.99

For more detailed product specifications and our complete selection visit [www.defender.com](http://www.defender.com) or call 800-628-8225.

**MAGMA MARINE KETTLE AND KETTLE 3 COMBINATION STOVE & GAS GRILL**

- New waterproof electronic pulse ignition
- 100% 18-9 mirror polished stainless steel
- Swiveling, windproof turbo venturi tube and new control valve/regulator for better performance
- Newly redesigned, heavy-duty, stainless steel inner safety shell: Keeps outer shell cooler; guards against discoloration
- "Stay Cool" cast 18-9 stainless steel handle with air cooled supports



**A. MAGMA MARINE KETTLE 3 COMBINATION STOVE & GAS GRILL**

Item	Model	Size/Diameter	Grilling Area	Ship	Net
401657	A10-207-3	15" (Original size)	14" dia.	9 lbs	\$234.99
401658	A10-217-3	17" (Party size)	16" dia.	9 lbs	289.99

**MAGMA MARINE KETTLE GAS GRILL**

- 100% 18-9 mirror polished Stainless Steel
- "Stay Cool" heat resistant all weather plastic handle with air cooled supports
- Perfectly balanced hinged lid will not slam shut

Item	Model	Size/Diameter	Grilling Area	Ship	Net
400640	A10-205	15" (Original size)	14" dia.	10 lbs	\$174.99
400641	A10-215	17" (Party size)	16" dia.	12 lbs	206.99

**B. MAGMA CABO ADVENTURER MARINE SERIES GAS GRILL**

- 100% 18-8 mirror polished stainless steel
- Fold-away table top legs, perfect for that quick picnic onshore
- "Stay Cool" heat resistant all weather plastic handle with air cooled supports
- Side access, lock-in-place grease tray

Item	Model	Grilling Area	Ship	Net
402781	A10-703	9" x 18"	18 lbs	\$192.99

**C. MAGMA CONNOISSEUR SERIES GAS GRILL**

- 100% 18-9 stainless steel
- Full length handle and fold away legs
- Uses disposable 1 lbs propane canisters
- Front access, lock-in-place grease tray
- Adapts to on-board LPG (propane) or CNG (natural gas)

Item	Model	Description	Grilling Area	Ship	Net
400638	A10-801	TrailMate	9" x 12"	13 lbs	\$199.99
400639	A10-803	ChefsMate	9" x 18"	17 lbs	239.99

**MAGMA GRILL PADDED CARRYING/STORAGE CASE**

Item	Model	Fits grilling area	Ship	Net
402222	A10-992	9" x 18"	6 lbs	\$68.99
402223	A10-1292	12" x 18"	7 lbs	71.99
402224	A10-1293	12" x 24"	8 lbs	79.99
401127	A10-991	Round kettle	5 lbs	64.99



Note: Canister, mount and serving shelf sold separately for all grills. Warning DO NOT use legs on boat!

**D. MAGMA INFRARED GOURMET SERIES GAS GRILLS**

- New high-temp glass viewing window
- New elegant design: no sharp edges
- Redesigned combustion system: won't blow out
- New electronic ignition system: always lights
- Infrared radiant screens: intense even heat
- 100% 18-9 mirror-polished stainless steel
- Stainless Steel hermetically sealed thermometer
- Made in the USA
- Integrated fold-away legs
- Full inner lined safety shell
- Locking front access grease tray
- Full-length stainless steel handle
- Oversized lockable lid
- Swiveling control/valve regulator

Item	Model	Description	Grilling Area	Ship	Net
401612	A10-918-2GS	Newport II	9" x 18"	24 lbs	\$439.99
401613	A10-1218-2GS	Catalina II	12" x 18"	37 lbs	529.99
401614	A10-1225-2GS	Monterey II	12" x 24"	40 lbs	629.99

Secondary: 5-1/2" x 18"  
Secondary: 5-1/2" x 24"

**MAGMA CLASSIC GOURMET SERIES PROPANE GAS GRILL**

These grills possess all the same features listed above except for glass viewing window and infrared radiant screens.

Item	Model	Description	Grilling Area	Ship	Net
401609	A10-918-2	Newport II	9" x 18"	24 lbs	\$379.99
401610	A10-1218-2	Catalina II	12" x 18"	37 lbs	479.99
401611	A10-1225-2	Monterey II	12" x 24"	40 lbs	559.99

Secondary: 5-1/2" x 18"  
Secondary: 5-1/2" x 24"

**MAGMA GRILL COVERS**

Manufactured using Sunbrella® fabric. Mold, mildew and fade resistant. Available in 6 colors: Burgundy, Captain's Navy, Forest Green, Jet Black, Pacific Blue or Royal Blue. All ship 1 lbs.

Item	Fits	Net	Item	Fits	Net
401739	15" Kettle	\$51.99	401979	9" x 18"	\$59.99
401970	17" Kettle	55.99	401980	12" x 18"	71.99
402183	9" x 12"	49.99	401981	12" x 24"	79.99



**SHELVES, CLEANING STATIONS & GRILLING ACCESSORIES**

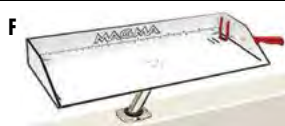
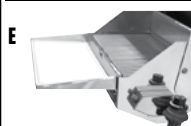

**E. MAGMA RECTANGULAR GRILL SERVING SHELF**

Stainless steel body with UV stabilized FDA approved polyethylene cutting board.

Item	Model	Size	Ship	Net
402182	A10-901	11-1/4" W x 1-7/16" H x 7-1/2" D	3 lbs	\$44.99
401972	A10-902	17-1/4" W x 1-7/16" H x 7-1/2" D	4 lbs	58.99

Note: A grilling accessory and serving shelf only. Not designed to cut or filet on.

**F. MAGMA BAIT/FILET MATE™ TABLE**

High-density color core polyethylene - UV stabilized, FDA approved

Item	Model	Size	Ship	Net
402548	T10-303B	31" x 12-1/2" (without mount)	11 lbs	\$98.99
401502	T10-310B	16" x 20" (with stainless steel hinged mount)	7 lbs	71.99
401500	T10-302B*	20" x 12-3/4" (without mount)	6 lbs	68.99
401503	T10-312B	20" x 12-3/4" (with LevelLock® stainless steel all-angle rod holder mount)	8 lbs	119.99
401504	T10-313B	31" x 12-1/2" (with LevelLock stainless steel all-angle rod holder mount)	12 lbs	152.99

**G. FIRST MATE DUAL MOUNT CUTTING & FOOD SERVING TABLES**

Item	Model	Size	Ship	Net
401586	T10-503B*	31" L x 12-1/2" W	11 lbs	\$96.99
401587	T10-504B*	41" L x 12-1/2" W	14 lbs	109.99
401588	T10-505B*	51" L x 12-1/2" W	17 lbs	119.99

**H. TOURNAMENT SERIES™ FISH CLEANING STATIONS**

- Injected molded polyethylene
- Knife/plier holsters
- Optional table mounts available
- Won't fade, crack or retain odors
- UV stabilized

Item	Model	Size/Description	Ship	Net
400744	T10-420*	20" x 16" x 4-1/2" Table only	8 lbs	\$94.99
400642	T10-421	20" Table, w / LevelLock fish rod holder mount	10 lbs	134.99

**I. TOURNAMENT SERIES DOCK CLEANING STATION**

- High density polyethylene
- UV stabilized
- (3) 1-1/2" rail mounts and a 1-1/2" tubular stainless steel base
- Knife/plier holsters
- Won't fade, crack or retain odors

Item	Model	Size	Ship	Net
402541	T10-448B-HDP*	47-1/2" L x 19-1/2" W	37 lbs	\$184.99
402542	T10-449B-HDP	47-1/2" L x 19-1/2" W, Stand height: 38-1/32"	37 lbs	349.99

\* Table only (hardware sold separately)

**GRILL AND TABLE MOUNTS**

Item	Model	Description	Ship	Net
400081	A10-080	Kettle, Round rail, 7/8" or 1"	1 lbs	\$55.99
400082	A10-085	Kettle, Round rail, 1-1/8" or 1-1/4"	1 lbs	55.99
400645	A10-121	Kettle, Surface deck socket	2 lbs	55.99
400103	A10-175	Kettle, Pow'r Grip® fish rod holder	2 lbs	66.99
400087	A10-650	Kettle, On-shore stand	2 lbs	34.99
400332	T10-380 SD	Single, Round rail, 7/8" to 1"	1 lbs	46.99
402185	T10-527 HD	Dual, Pow'r Grip/Levelock deck socket	3 lbs	87.99
400112	T10-580 HD	Dual, Round rail, 7/8" or 1"	2 lbs	71.99
400113	T10-585 HD	Dual, Round rail, 1-1/8" or 1-1/4"	2 lbs	71.99
400126	T10-355 HD	Levelock Fish rod holder	2 lbs	68.99
400646	T10-521 HD	Dual, Surface deck socket	2 lbs	69.99
400647	T10-526 HD	Dual, Flush deck socket	2 lbs	69.99
400713	T10-185 SD	Pedestal mount Height: 28", Base diameter: 7"	4 lbs	94.99

SD= Standard Duty HD= Heavy Duty

**MAGMA GRILL REPLACEMENT PARTS**

402059	10-665	Radiant burner and dome for marine Kettle combination stove and gas grill, original and party size, marine Kettle 2 and 3 combination stove and gas grill; priginal size	2 lbs	\$45.99
402060	10-765	Radiant burner and dome for marine Kettle 2 and 3 combination stove and gas grill; Party size	2 lbs	43.99
400648	10-954*	Grill grate (6" x 9"), 9" x 12" and 9" x 18" grills	1 lbs	21.99
400649	10-1254*	Grill grate (6" x 12"), 12" x 18" and 12" x 24" grills	1 lbs	25.99
400743	10-262	Control valve regulator, X-low output	1 lbs	37.99
401763	10-263	Control valve regulator, low output	1 lbs	37.99
400610	10-264	Control valve regulator, med. output	1 lbs	37.99
400609	10-265	Control valve regulator, high output	1 lbs	37.99

\* Multiple grates required per grill; quantity varies by grill size.

**TACO POLY FILET TABLE**

- Includes adjustable rod holder mount
- UV stabilized, high density polyethylene; FDA approved

Item	Model	Size	Ship	Net
401264	P01-2120W	20" W x 12" L	8 lbs	\$86.99
401265	P01-2132W	32" W x 12" L	12 lbs	116.99





## Kuuma Grills & Accessories



Kuuma grills are designed for use on boats and built to withstand harsh marine environments. All are constructed of high-quality stainless steel and come fully assembled.

### ELITE 216 GAS GRILL

- Grill area: Primary 171.5 sq. in. / Secondary 44.5 sq. in.
- Dimensions: 22" L x 15" D x 13" H
- Locking lid, fold away legs, Lift & Clean™ inner liner

Item	Model	Heat Output	Ship	Net
401478	58155	13,000 BTU	41 lbs	\$246.99



58155 open

### ELITE 316 GAS GRILL

- Grill area: Primary: 231 sq. in. / Secondary: 85 sq. in.
- Dimensions: 27" L x 15" D x 13" H
- Locking lid, fold away legs and Lift and Clean inner liner

Item	Model	Heat Output	Ship	Net
401479	58173	14,000 BTU	51 lbs	\$299.99



58173 open

### STOW N' GO 125 GRILL PROPANE GAS BBQ GRILL

- Material: Polished Stainless steel with hinged lid
- Grill Area: 13-1/2" L x 8-7/8" W
- Can be easily transported or mounted to any Kuuma rail, rod or pedestal mount (Sold separately)

Item	Model	Heat Output	Ship	Net
402557	58140	9,000 BTU	13 lbs	\$157.99



58140

### STOW N' GO 160 GAS GRILL

- Includes regulator
- 160 sq. in. of cooking area
- Dimensions: 23.25" L x 11.25" D x 11" H
- Locking lid, fold away legs and grease tray

Item	Model	Heat Output	Ship	Net
402097	58130	12,000 BTU	16 lbs	\$162.99



58130

### STOW N' GO 160 GAS GRILL - WITH THERMOMETER

- Includes igniter and thermometer
- 160 sq. in. of cooking area
- Dimensions: 23.25" L x 11.25" D x 11" H
- Features locking lid, fold away legs and grease tray

Item	Model	Heat Output	Ship	Net
401477	58131	12,000 BTU	16 lbs	\$189.99



See all of the Kuuma Grill Mounts and Accessories at [www.defender.com](http://www.defender.com)

### STOW N' GO 160 CHARCOAL BBQ GRILL

- Material: Polished stainless steel with hinged lid.

Item	Model	Heat Output	Ship	Net
400255	58110	N/A Charcoal	17 lbs	\$154.99



58110

### PROFILE 150 GRILL

- 145 sq. in. of cooking surface
- Integral foldaway legs and removable grease tray
- Propane model runs off 11lbs disposable bottles or larger tank with hose adapter

Item	Model	Heat Output	Ship	Net
402197	58121	9,000 BTU	14 lbs	\$162.99



58121

### Electric, 110 Volt AC 15A

402198	58120	700° surface temp	14 lbs	\$249.99
--------	-------	-------------------	--------	----------



58120

### PROFILE 216 GRILL

- 180 sq. in. of cooking surface
- Propane with regulator
- Removable grease tray
- Integral foldaway legs
- Propane runs off 1 lbs. disposable bottles or larger
- No assembly required
- Stainless steel construction

Item	Model	Heat Output	Ship	Net
402199	58161	13,000 BTU	14 lbs	\$178.99



Optional mounts sold separately at [www.defender.com](http://www.defender.com)

### 15" KETTLE BBQ GRILL

- Grill Area: 15" Dia. (177 sq. in.)
- Dimensions: 18.4" H x 16.5" W x 11.5" D
- Material: Stainless steel
- Stay-cool handle
- Latching lid and removable heat plate/liner assembly for easy cleaning

### Propane Model with Twist Lock Regulator

Item	Model	Heat Output	Ship	Net
402472	58102	9,000 BTU	14 lbs	\$185.99

### Charcoal Model

402473	58103	N/A Charcoal	12 lbs	\$162.99
--------	-------	--------------	--------	----------

### 15" Kettle Base Legs

- Converts Kuuma marine kettle grills for onshore use
- Material: Stainless steel

Item	Model	Ship	Net
402474	58109	2 lbs	\$36.99



## Grill Mounts



Item	Model	Description	Ship	Net
402201	58260	Floor base plate fits model 58184 pedestal	5 lbs	\$33.99
401480	58183	Rail mount for all Stow N' Go, Profile and Elite grills	2 lbs	\$49.99
402099	58182	Rail mount for all Stow N' Go, Profile and Elite BBQs, round or square rail. One rail mount required	2 lbs	\$39.99
402100	58180	60" rod holder mount for all Stow N' Go, Profile and Elite BBQs	2 lbs	\$41.99
400339	58184	Pedestal mount for all Stow N' Go, Profile and Elite BBQs	5 lbs	\$85.99
401558	58208	Table mount replacement knobs	1 lbs	\$4.49
401662	58195	Quick Release Inboard/Outboard boat rail grill mount	2 lbs	\$47.99

Grill mounts above also fit all kettle grills.

## Kuuma BBQ Accessories



Item	Model	Description	Ship	Net
401484	58380	Fish/Veggie grilling tray with removable handle (8" x 10")	2 lbs	\$25.99
402204	58230	Food tray fits Profile 150 and 216	4 lbs	\$49.99
401482	58233	Food tray fits Stow N' Go 160 and Elite 316	4 lbs	\$59.99
402098	58300	Cover/Tote fits: Stow N' Go 125 and 160, Profile 150 and Cubed 150	1 lbs	\$33.99
401483	58303	Cover/Tote fits 216 Elite and 316 Elite	1 lbs	\$44.99
402205	58251	Replacement heat dispersion plates for Profile 150 and 216 grills - Stainless Steel, each	3 lbs	\$8.99
400590	58275	High pressure replacement propane gas BBQ regulator for Pre 2016 Grills	1 lbs	\$36.99
402261	59823	LPG propane gas adapter hose assembly (5')	2 lbs	\$33.99
401893	58319	Kuuma kettle grill tote / cover	1 lbs	\$34.99
401757	58211	Propane gas BBQ grill replacement burner fits Profile 150, 216, Stow N' Go 160, Elite 316	1 lbs	\$38.99

## Dickinson Grills, Mounts & Accessories

### SEA-B-QUE SMALL & LARGE

- 20 gauge, high-grade stainless steel
- Roll away hood
- Porcelain non-stick, no-flare grill surface
- Igniter (large), deck legs, thermometer and drip tray
- Exceptionally rugged marine grills
- 3-year burner warranty with proof of purchase

Item	Model	Grill Surface	Ship	Net
400063	00-SBQ-S Small	148 in <sup>2</sup> (9.25" x 16") BTU: 10,000	18 lbs	\$234.99

400064	00-SBQ-L Large	220 in <sup>2</sup> (11" x 20") BTU: 11,000	34 lbs	\$299.99
--------	----------------	------------------------------------------------	--------	----------



### DICKINSON BARBECUE MOUNTS

Fit all Dickinson BBQs.

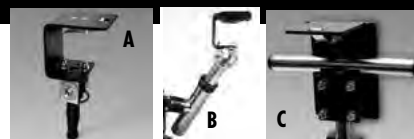

Item	Model	Description	Ship	Net
A	400153	15-150P "Scotty Type" Post and Socket Mount fits into a scotty type rod holder socket. Universal angle joint, quick disconnect	2 lbs	\$76.99
B	402040	15-150F Fishing Rod Holder Mount Kit Adapts to most fishing rod holders. Universal joint, quick release clip.	3 lbs	\$76.99
C	400233	15-150A Universal Rail Mount Kit Fits a 7/8" to 1" round or square rail and mounts your Dickinson BBQ on a vertical, horizontal or angled rail. Quick disconnect.	2 lbs	\$62.99

## Trident Propane Products



TRIDENT MARINE



### 12 VDC LP GAS CONTROL/ DETECTION SYSTEM

Turns LP gas on or off from the galley. Monitors area(s) for presence of gas fumes. Automatically turns off the solenoid valve and activates an audio alarm if fumes are detected at 10% lower explosion limit (LEL). Will support FPT port and 10' quick connect detector wire cable.

Item	Model	Description	Ship	Net
400342	1300-7761-KIT	With solenoid, includes 3/8" male fittings	2 lbs	\$299.99
400343	1300-7760	Without solenoid	1 lbs	219.99



### 12 VDC BRASS LOW PRESSURE LP GAS SOLENOID VALVE

UL listed, CE certified, full flow solenoid. 5/16" orifice and 3/8" FPT ports. Draws .079 amps when in use. Dimensions: 2.63" H x 2" W x 1.63" D

Item	Model	Description	Ship	Net
400454	1300-7706.2-KIT	Includes (2) connect fittings	2 lbs	\$109.99



### 12 VDC BRASS LOW PRESSURE LP GAS SOLENOID VALVE

UL listed, CE certified, full flow solenoid. 5/16" orifice and 1/4" FPT ports. Draws .079 amps when in use. Dimensions: 2.5" H x 1.5" W x 1.35" D

Item	Model	Description	Ship	Net
501250	1300-7708.2-KIT	Kit includes (2) connect fittings	2 lbs	\$99.99

### 24 VDC BRASS LOW PRESSURE LP GAS SOLENOID VALVE

UL listed, CE certified, full flow solenoid. 5/16" orifice and 1/4" FPT ports. Draws .079 amps when in use. Dimensions: 2.5" H x 1.5" W x 1.35" D

Item	Model	Description	Ship	Net
401116	1300-7708.2-24V	Kit includes (2) connect fittings	2 lbs	\$119.99



### LPG PROPANE GAS CONTROL PANEL

• Turns propane On/Off from inside the galley; Power: 12 or 24VDC  
• Dimensions: 3-3/4" H x 2-7/8" W x 7/8" D; UL listed

Item	Model	Ship	Net
401144	1300-7703.1	1 lbs	\$74.99



### 12 VDC LP GAS CONTROL SYSTEM

• Turns propane On/Off from galley • Power: 12VDC  
• Includes control panel, 3/8" solenoid and (2) connection fittings  
• Panel Size: 3-3/4" W x 2-7/8" H x 7/8" D  
• Draws 953 mA when ON and propane is in service

Item	Model	Ship	Net
400161	1300-7705.3-KIT	2 lbs	\$139.99



### 12/24 VDC LP ADD-ON GAS DETECTOR

• Marine UL listed 95 dB alarm with Red function light  
• Detector remains on and monitoring even when gas control panel is off  
• Sends an alarm signal to panel when LP gas is present at 10% lower explosion limit (LEL) or more  
• Works with Trident: 1300-7760 and 1300-7761-KIT systems; Draws 163 M.A  
• Requires 10' or 20' quick connect cable

Item	Model	Ship	Net
400451	1300-7720	1 lbs	\$59.99



### QUICK CONNECT DETECTOR CABLE

Connects to a 12/24VDC gas control panel in a snap with no crimping or taping necessary.

Item	Model	Ship	Net
400452	1300-7721-120	1 lbs	\$34.99
400453	1300-7721-240	1 lbs	51.99

## Fireboy Propane Products



### FIREBOY-XINTEX PROPANE FUME DETECTOR WITH (1) SENSOR

• Detects propane leaks easily • Includes 20 ft. extension cable  
• 68 dBA alarm and red LED danger light  
• Type: Single channel • Style: 2-3/16" Round bezel  
• Cutout: 2-1/16" Round • Power: 9-30VDC

Item	Model	Color	Ship	Net
552592	P-1B-R	Black	1 lbs	\$179.99



### FIREBOY-XINTEX PROPANE FUME DETECTOR WITH (2) SENSORS AND SOLENOID

• Detects propane leaks easily  
• Includes (2) 20 ft. extension cable and a 3/8" x 1/4" adapter  
• 68 dBA alarm and red LED danger light  
• Type: 2-channel • Style: Square bezel  
• Cutout: 2-1/16" Round • Power: 9-30VDC

Item	Model	Color	Ship	Net
552595	P-2BS-R	Black	2 lbs	\$319.99

## Gas System Lockers



### TRIDENT STEEL PROPANE TANKS & FITTINGS

• Corrosion-resistant, enamel-painted steel tank  
• Has a Type I valve and overflow protection device (OPD)  
• All tanks are DOT approved  
• Manufacturer's one year limited warranty

Item	Model	Description	Size	Ship	Net
400181	1400-0005	5# Vert.	12.4" x 8"	11 lbs	\$104.99
400182	1400-0011	11# Vert.	12.5" x 12.5"	15 lbs	109.99
400183	1400-0011T	11# Vert.	17-1/8" x 8-7/8"	14 lbs	104.99
400184	1400-0020	20# Vert.	17.75" x 12.4"	17 lbs	61.99
400185	1400-0020H	20# Horz.	12.2" x 12.2" x 17.4"	18 lbs	219.99



### TRIDENT ALUMINUM PROPANE TANKS

• Welded aluminum, corrosion-resistant tanks  
• Brass valves and safety overflow protection (OPD)  
• Aluminum is particularly suitable for use in the marine environment  
• All tanks are manufactured to D.O.T. specifications. All 10# & 20# cylinders are also TC approved for Canadian use.

Item	Model	Description	Size	Ship	Net
400175	1410-0006	6# Vert.	22.5" x 6.3"	9 lbs	\$259.99
400176	1410-0010	10# Vert.	16.5" x 10.5"	11 lbs	214.99
400177	1410-0010H	10# Horz.	11" x 10.5" x 16.5"	13 lbs	369.99
400178	1410-0020	20# Vert.	20.5" x 12.5"	15 lbs	239.99
400179	1410-0020H	20# Horz.	12" x 12.6" x 20.6"	18 lbs	409.99
400180	1410-0030	30# Vert.	26.5" x 12.5"	18 lbs	274.99

### TRIDENT SEE-THROUGH COMPOSITE LPG TANKS

• Gas level is visible thanks to the special see-through construction  
• Non-Corrosive 3 layer Fiberglass Composite Cylinder. Ergonomic Collar & Handle New Type I Valve and OPD. DOT & TC Approved.  
• When empty, the cylinder weighs about 50% less than steel cylinders.  
• Color: Blue/White



Item	Model	Vertical Tank Size	Size	Ship	Net
400714	1420-0011	11 lbs	15.24" H x 12" D	11 lbs	\$139.99
400468	1420-0017	17 lbs	18.1" H x 12" D	11 lbs	142.99



### TRIDENT FULLY RIGGED LP GAS SYSTEM LOCKERS

• Roto Molded • 20" QCC Pigtail Hose  
• Regulator Assembly with leak test gauge  
• 12VDC, 3/8" FPT ports Brass Solenoid  
• 12VDC On/Off Gas Control Panel  
• Straight Thru Fittings for Supply Hose and Solenoid Wiring  
• Locker Ventilation Thru Fitting

Item	Model	Capacity	HxWxD	Ship	Net
402582	1601-0011	11 lb.	17.68"x15"x15.5"	30 lbs	\$519.99
402583	1602-1011	10/11 lb.	18.44"x27"x14.75"	48 lbs	599.99
402584	1602-1720	17/20 lb.	23.19"x27"x14.75"	60 lbs	619.99

\*Dual cylinder models



### TRIDENT SINGLE ROTO MOLDED CYLINDER LOCKER

• Roto Molded  
• 20" QCC Pigtail Hose  
• Regulator Assembly with leak test gauge  
• 12VDC, 3/8" FPT ports Brass Solenoid  
• 12VDC On/Off gas control panel  
• Straight thru-fittings for Supply Hose and Solenoid wiring  
• Locker ventilation thru-fitting  
• 1601-1720-KIT includes composite

Item	Model	Description	H x D x W	Ship	Net
401815	1601-1720	No tank	20.94" x 15.5" x 15"	33 lbs	\$549.99
401816	1601-1720-KIT	Tank included	20.94" x 15.5" x 15"	33 lbs	639.99

## Gas Grill Fittings



### MAGMA CONTROL VALVES

• For use with pre-regulated propane systems  
• Hose and fittings purchased separately

Item	Model	Description	Ship	Net
402210	A10-219	Extra low output; Type 3 (LPG) Magma; 9" x 12" rectangular grills	1 lbs	\$37.99
400169	A10-220	Low output; Type 3 (LPG); All Magma marine kettles and 9" x 18" rectangular gas grills	1 lbs	37.99
401373	A10-223	Medium output; Type 3 (LPG); Magma 12" x 18" rectangular gas grills	1 lbs	37.99
401374	A10-224	High output; Type 3 (LPG); Magma 12" x 24" rectangular gas grills	1 lbs	37.99

❖ For more detailed product specifications and our complete selection visit [www.defender.com](http://www.defender.com) or call 800-628-8225. ❖



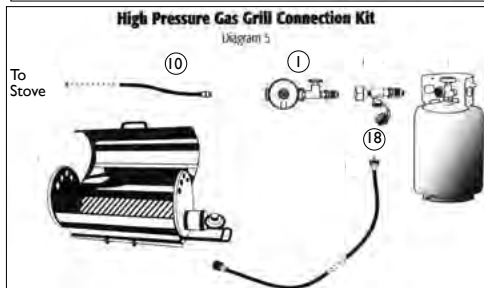
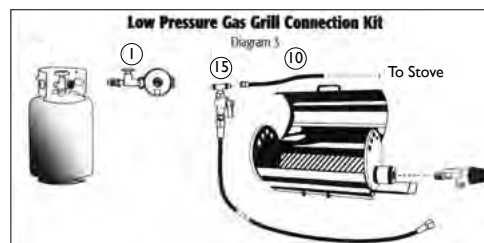
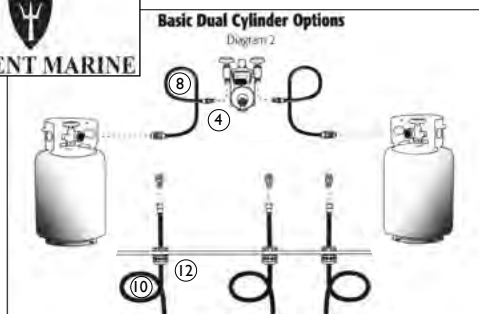
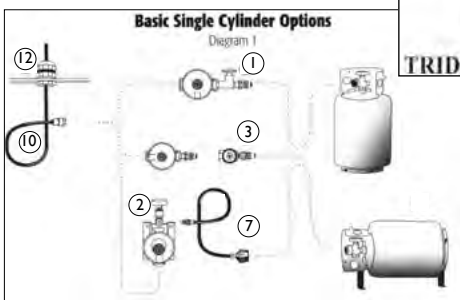

**MARINE LPG REGULATOR SINGLE STAGE WITH GAUGE**  
 Compact, low pressure regulator that meets ABYC marine standards with gauge for required LPG system leak test. Solid brass: male POL cylinder fitting, street tee and 300 psi gauge (Low profile, water tight, stainless steel) and UL listed die cast zinc body with 3/8" FPT outlet. 140,000 BTU capacity.  
 Item **400202** Model 1200-1411 Ship 2 lbs **Net \$74.99**

**High Pressure Gas Grill Adapter Hose**  
 Diagram 4  
 Item **400188** Model 40407-72 6 ft. hose Ship 2 lbs **Net \$54.99**  
 Item **400189** Model 40407-144 12 ft. hose 2 lbs **Net \$63.99**

**SINGLE STAGE BRACKET MOUNT REGULATOR W/GAUGE, 20" PIGTAIL**  
 The most compact low pressure regulator that meets ABYC marine standard with gauge for required LPG system leak test. It is fully assembled and leak tested with solid brass male POL cylinder fitting, street tee and 300 PSI gauge.  
 Item **400203** Model 1211-1401 Ship 2 lbs **Net \$79.99**

**STRAIGHT-THRU FITTING-LIQUID AND VAPOR TIGHT**  
 ABYC approved vapor water tight fitting to lead LPG and copper supply lines through propane lockers, decks and bulkheads. Install over LPG and copper line assemblies with fittings attached. LPG fittings accept LPG hoses up to 5/8". Tubing/wire accepts copper tubing up to 3/8".  
 Item **400200** 1438-8439 Supply line hose Ship 1 lbs **Net \$18.99**  
 Item **400201** 1438-8876 Copper tubing 1 lbs **Net \$12.99**

**SINGLE STAGE WALL MOUNT ASSEMBLY WITH GAUGE, 20" PIGTAIL**  
 300 psi gauge and mounting brackets; includes 20" high pressure hose (pigtail) with QCC style coupler. These tanks accept both the old internal thread and the new external thread QCC style couplings. Meets ABYC marine LPG standards.  
 Item **400916** Model 1211-1402 Ship 2 lbs **Net \$82.99**

**MARINE RESERVE DISPOSABLE CYLINDER ADAPTER**  
 Enables you to adapt a disposable propane bottle to your onboard propane system.  
 Item **400206** G-487 Ship 1 lbs **Net \$36.99**

**REGULATOR MOUNTING BRACKET**  
 Pre-drilled to attach to underside of all Trident regulators for mounting remote from cylinder to flat surface within LPG locker. Set of 2 includes (4) self tapping screws.  
 Item **400207** Model 1250-0002 Clad plate Ship 1 lbs **Net \$10.99**  
 Item **400208** Model 1250-0000 Stainless steel 1 lbs **Net \$21.99**

**U.S. LPG SYSTEM ADAPTER**  
 LPG adapter to european "camping gaz" cylinder. Solid brass. U.S. female POL receptacle, AGA ball valve and European (metric) male M16x1.5 fitting with rubber gasket. Attach female end to US regulator or pigtail POL (with valve off), then male end into "camping gaz". 4.5" H x 4" W x 1.63" D.  
 Item **400164** 1195-1615 Ship 1 lbs **Net \$132.99**

**MARINE LPG LEAK TEST ADAPTER WITH GAUGE**  
 Meets ABYC marine standard for required LPG system leak test by installing this between LPG cylinder and regulator or pigtail hose. Fully assembled and leak tested with solid brass male POL cylinder fitting, female POL receptacle block and 300 psi gauge (Low profile, water tight, stainless).  
 Item **400204** Model 1190-1411 Ship 1 lbs **Net \$64.99**

**EUROPEAN "CAMPING GAZ" SYSTEM ADAPTER**  
 European "camping gaz" system adapter to U.S. LPG cylinders. Assembled with solid brass U.S. male swivel POL cylinder fitting and european (metric) female M16 x 1.5 receptacle. Securely attach female end to "camping gaz" regulator and male end into U.S. cylinder valve.  
 Item **400163** 1190-1625 Ship 1 lbs **Net \$64.99**

**MARINE 2 STAGE-AUTO CHANGE OVER LPG REGULATOR**  
 Includes (2) 300 psi gauges, mounting bracket and 3/8" FPT outlet. Meets ABYC std. Uses 2 high pressure pigtails to LPG cylinders. 6"H x 5.5"W x 4"D.  
 Item **400205** Model 1230-1411 Ship 3 lbs **Net \$159.99**

**TRIDENT MARINE LPG PROPANE GAS HIGH-PRESSURE GRILL CONNECTION TEE**  
 Installs between tank valve and regulator or pigtail POL fitting. Assembled with brass fittings and leak tested. Use with high pressure gas grill connection hoses.  
 Item **400191** G-415 Ship 1 lbs **Net \$64.99**

**LPG PIGTAIL CONNECTOR - REMOTE REGULATOR CONNECTIONS**  
 Connect remote mounted regulator (1) or (2) to cylinder. Fully assembled and leak tested with solid brass male POL cylinder fitting x female POL receptacle and 1/4" ID. UL listed, high pressure, 20" LPG hose.  
 Item **400192** Model 1014-1402-20 Ship 1 lbs **Net \$34.99**

**LOW PRESSURE GAS GRILL CONVERSION KIT**  
 Converts gas grill from small disposable bottles to larger refillable cylinders. This low pressure installation provides additional safety of less than 1/2 psi in hose to gas grill. Use with a low pressure control valve at the gas grill that is recommended by its manufacturer. Assembled, leak tested with brass tee, ball valve, adapters and a 10 ft., UL, high pressure LPG hose.  
 Item **400186** G-265-120 Ship 2 lbs **Net \$72.99**

**LPG HIGH PRESSURE PIGTAIL HOSE (Quick-Closing Coupling)**  
 Used to connect wall mount regulators to cylinders with new type I valves (Outside RH threads). 20" high pressure hose with 1/4" male inverted flare fitting X thermoplastic QCC nut for quick and easy hand tight connection. UL Listed.  
 Item **401921** Model 1014-1415-20 Ship 1 lbs **Net \$29.99**

**LPG HIGH PRESSURE PIGTAIL HOSE**  
 Use to connect wall mount regulators to LPG cylinders (Inside valve - left hand thread). Fully assembled and leak tested with solid brass: male POL cylinder fitting, 1/4" male inverted flare and high pressure, thermoplastic LPG hose, UL Listed assembly. 20" standard length. UL listed assembly.  
 Item **400210** Model 1014-1401-20 Ship 1 lbs **Net \$24.99**

**HIGH PRESSURE GAS GRILL ADAPTER HOSE**  
 Easily converts gas grills or other portable LPG appliances from small disposable bottles to a larger refillable cylinder. Includes wheel POL cylinder fitting; H.P. appliance valve fitting (1" 20 swivel male with O-ring and check valve).  
 Item **400188** Model 40407-72 6 ft. hose Ship 2 lbs **Net \$54.99**  
 Item **400189** Model 40407-144 12 ft. hose 2 lbs **Net \$63.99**

**LPG SUPPLY LINE HOSE**  
 We prefer supply line hose to copper tubing because it won't develop stress fatigue cracks, and it is much easier to install. Solid brass fittings (3/8" female swivel flare) and high pressure LPG hose. Assemblies are UL Listed. No. 1014-3838-XX.

	2 ft.	Ship 1 lbs	<b>Net \$24.99</b>
	5 ft.	1 lbs	<b>27.99</b>
	10 ft.	2 lbs	<b>45.99</b>
	15 ft.	2 lbs	<b>64.99</b>
	20 ft.	3 lbs	<b>75.99</b>
	25 ft.	4 lbs	<b>121.99</b>
	30 ft.	5 lbs	<b>132.99</b>
	35 ft.	6 lbs	<b>159.99</b>
	40 ft.	6 lbs	<b>179.99</b>

Item **401764**  
 Please Specify Size

**HIGH PRESSURE GAS GRILL CONVERSION KIT**  
 High pressure 6' LPG hose fully assembled and leak tested with solid brass swivel fitting (1" 20 female for tee connection) x (1" 20 male with O-ring and check valve for H.P. appliance connection). Tee # G-415 included in kit.  
 Item **400190** G-415-72 Ship 2 lbs **Net \$109.99**



Stoves & Ranges



**Force 10 and ENO Gas Ranges**

These gourmet gimballed ranges are designed with features that make cooking a great onboard meal safe and easy. Slide away oven door recesses underneath to maximize galley space. **Force 10 Ranges feature:**

- Adjustable potholder
- Positive, two-position oven door with clear window
- Stainless steel burner caps
- Convection cooking atmosphere
- One-button electronic ignition
- Push-to-turn burner controls
- Strong oven rack system
- Removable top grate

**ENO Propane Ranges With Oven**

- Enameled oven with European styling
- Same features as the Force 10 ranges

- K. ENO Open Sea Gimballed 2 Burner With Oven**
- L. ENO Gascogne Gimballed 3 Burner With Oven**

**ENO Perigord Built-In Oven**

- M. Perigord Propane Gas Oven - Gourmet Version**

- Stainless steel oven and broiler
- Stainless handle
- Compact design

**Compact Propane Ranges With Oven**

- A. North American Compact Gimballed 3 Burner**
- B. American Compact Gimballed 2 Burner**
- C. European Sub Compact Gimballed 3 Burner**
- D. European Compact Gimballed 3 Burner**
- E. European Compact Gimballed 2 Burner**

**Standard Propane Ranges With Oven**

- F. Euro-Standard 3 Burner**
- G. North American Standard Gimballed 2 Burner With Oven/Infrared broiler**
- H. North American Standard Gimballed 3 Burner With Oven/Infrared Broiler**
- I. North American Standard Gimballed 4 Burner With Oven/Infrared Broiler**

**Electric Range With Oven**

- J. Gimballed 3 Burner**
  - Ceramic glass top range
  - Hot surface indicator light for safety
  - Thermostatically controlled oven with light and broiler
- Slide away door for maintaining gimbal
- Comes complete with pot retention device

**FORCE 10 ACCESSORIES**

Item	Model	Description	Ship	Net
401531	70002	Trim kit for F63251, F63256	6 lbs	\$99.99
	70034	Trim kit for F63351, F63356, F63451	6 lbs	99.99
402478	870015	Battery holder	1 lbs	14.99
402289	205211	Oven rack F63251, F63253, F63353, F63453, 73251 and 73253	2 lbs	49.99
400589	305211	Oven rack F63351, F63451, 73351, 73353 and 73451	2 lbs	47.99
402287	72645	(4) outlet spark ignition box for (2) burner ranges	1 lbs	72.99
402288	72655	(6) outlet spark ignition box for (3) and (4) burner ranges	1 lbs	82.99

Item	Model	# of Burners	Heat Source	Burner	Ignition	Dimensions (W x D x H)	Warranty (Years)	Ship	Net
<b>Compact/Sub Compact Propane Ranges – Stainless / Glass Door</b>									
A	401803	63353	3	Propane	(1) 9,500 BTU, (2) 3,800 BTU burners thermostatic oven and radiant broiler	Electronic 21.6" x 21.9" x 20.9" See dimensional drawing at <a href="http://defender.com">defender.com</a>	2	77 lbs	\$1599.99
B	402402	63253	2	Propane	(1) 9,500 BTU, (1) 3,800 BTU burners thermostatic oven and radiant broiler	Electronic 21.6" x 17.5" x 21" See dimensional drawing at <a href="http://defender.com">defender.com</a>	2	68 lbs	1474.99
C	401811	63354	3	Propane	(1) 9,500 BTU, (2) 3,800 BTU burners, thermostatic oven and radiant broiler	Electronic 20" x 20.7" x 19.4" See dimensional drawing at <a href="http://defender.com">defender.com</a>	2	64 lbs	1599.99
D	402403	63358	3	Propane	(1) 9,500 BTU, (2) 3,800 BTU burners, thermostatic oven and radiant broiler	Electronic 20" x 21.9" x 20.9" See dimensional drawing at <a href="http://defender.com">defender.com</a>	2	80 lbs	1599.99
E	401849	63258	2	Propane	(1) 9,500 BTU, (1) 3,800 BTU burners thermostatic oven and radiant broiler	Electronic 20" x 17.5" x 20.9" See dimensional drawing at <a href="http://defender.com">defender.com</a>	2	63 lbs	1454.99
<b>Standard Propane Ranges – Stainless / Glass Door</b>									
F	402404	63356	3	Propane	(1) 9,500 BTU, (2) 3,800 BTU burners, thermostatic oven and radiant broiler	Electronic 20" x 21.9" x 23.2" See dimensional drawing at <a href="http://defender.com">defender.com</a>	2	78 lbs	\$1499.99
G	401796	63251	2	Propane	(1) 9,500 BTU, (1) 3,800, BTU burners thermostatic oven	Electronic 21.6" x 17.5" x 23.2" See dimensional drawing at <a href="http://defender.com">defender.com</a>	2	72 lbs	1454.99
H	401797	63351	3	Propane	(1) 9,500 BTU, (2) 3,800 BTU burners thermostatic oven	Electronic 21.6" x 21.9" x 23.2" See dimensional drawing at <a href="http://defender.com">defender.com</a>	2	82 lbs	1574.99
I	401798	63451	4	Propane	(2) 9,500 BTU, (2) 3,800 BTU burners thermostatic oven	Electronic 21.6" x 21.9" x 23.2" See dimensional drawing at <a href="http://defender.com">defender.com</a>	2	84 lbs	1684.99
<b>Compact Electric Range – Stainless / Glass Door</b>									
J	401530	F65335 (120VAC) F65336 (240VAC)	3	Electric	(3) 1,200 W burners 1,300 W oven 1,300 W broiler	Electric 20" x 20" x 21.75" See dimensional drawing at <a href="http://defender.com">defender.com</a>	2	75 lbs	\$1564.99 1564.99
<b>ENO Propane Ranges</b>									
K	402189	142340015301*	2	Propane	8,500 / 6,000 BTU burners 6,100 BTU oven	Electronic 20.4" x 18.4" x 17.9" See dimensional drawing at <a href="http://defender.com">defender.com</a>	2	57 lbs	\$999.99
L	402190	186340825301	3	Propane	8,500 / 6,000 / 3,400 BTU burners 6,100 BTU oven	Electronic 20.4" x 17.9" x 18.4" See dimensional drawing at <a href="http://defender.com">defender.com</a>	2	56 lbs	1084.99
<b>ENO Oven</b>									
M	402191	874371015301	NA	Propane	5,100 BTU (Broil)/ 4,775 BTU (Bake)	Electronic 21.5" x 19.7" x 17.2 See dimensional drawing at <a href="http://defender.com">defender.com</a>	2	51 lbs	\$999.99

\*All Stainless Steel construction with a see-thru Black glass door



**Stoves & Ranges**



Unique Look & High Quality Construction!

Shown with cutting board (included)



**Dickinson Propane Stoves**

These 100% heavy duty Stainless Steel stove/oven units are perfect for your boat. They feature efficient 11,000 and 7,000 BTU burners with safety "flame-out" protection. They also feature a 35 L thermostatically controlled oven with broiler.

- Oven size: 17" x 12.5" x 8" from bottom rack and 5" from top rack
- Thermostatically controlled oven complete with broiler
- Removable cutting board • Includes 1 set of potholders
- No electrical connections • 9 VDC battery included
- Gimballed or built-in installation options available

**A. Mediterranean 3 Burner Stove With Broiler**

**B. Caribbean 2 Burner Stove With Broiler**

**ACCESSORIES FOR GALLEY RANGES & STOVES**

**Dickinson (for Mediterranean and Caribbean models)**

Item	Model	Description	Ship	Net
400865	26-003	Gimbal kit	1 lbs	\$35.99
400587	19-100-20	20' Propane hose	3 lbs	\$9.99
400588	19-150	Pressure regulator kit*	1 lbs	119.99
400868	26-020	Potholder set (2)**	1 lbs	39.99
402498	26-020A	Potholder set (2)***	1 lbs	39.99
400863		Built-in stove kit for Caribbean	3 lbs	39.99
400864		Built-in stove kit for Mediterranean	3 lbs	39.99

\* Includes regulator, bracket and fittings for a 1 lb disposable bottle

\*\* For Dickinson Caribbean (2) burner stove

\*\*\* For Dickinson Mediterranean (3) burner stove

**Built-in & Portable Cooktops**



**2 BURNER DROP-IN PROPANE GAS STOVE**

- Hardware (included)
- CGA/AGA safety gas valve with automatic shut-off
- Output: (1) 11,000 and (1) 7,000 BTU
- Safe push-and-turn electronic ignition (battery included)
- Comes with pot holders and laminated pine cutting board
- Dimensions: 23" W x 14" D x 4.75" H
- Cutout: 22" W x 12.5" D x 5" H

Item	Model	Ship	Net
402095	00-2BP	26 lbs	\$619.99

**ENO DUO GIMBALLED 2 BURNER PROPANE COOKTOP**

- Electronic ignition
- CE approved
- Burner output: (1) 6,000 and (1) 8,500 BTU
- Thermocouple safety shut-off
- Used gimballed or as a countertop unit
- Made entirely of Stainless Steel
- Includes gimbal kit and a set of pan holders
- Dimensions: 10" x 19.7" x 15.5"



Item	Model	Ship	Net
402188	062391015301	13 lbs	\$384.99

	Item	Model	Heat Source	# of Burners	Burner	Ignition	Dimensions (W x D x H)	Cutout Dimensions (W x D x H)	Warranty (Years)	Ship	Net
<b>A</b>	400861	00-MED3B	Propane	3	11,000/7,000 BTU burners 7,000 BTU oven 4,500 BTU broiler	Electronic	20.375" x 20.25" x 21.750"	gimbal cutout dim. 22" x 21.5" x 23.75" built-in-kit dim. 22" x 21.5" x 21.75"	1	91 lbs	1639.99
<b>B</b>	400862	00-CAR2B	Propane	2	11,000/7,000 BTU burners 7,000 BTU oven 4,500 BTU broiler	Electronic	20.375" x 14.750" x 21.750"	gimbal cutout dim. 22" x 16" x 23.75" built-in-kit dim. 22" x 16" x 21.375"	1	79 lbs	1577.99

**Cooktops**



**C/D. ENO 2 & 3 BURNER COOKTOP**

- Low profile, drop-in Stainless Steel stove top
- Thermocouple safety shut-off
- Electronic spark ignition • CE approved

**FORCE 10 CERAMIC GLASS ELECTRIC COOKTOPS**

Force 10 Black ceramic glass radiant cooktops add a touch of class to any galley. With powerful 1200 Watt burners and a smooth easy-to-clean surface, cooking and cleanup is a breeze. Safety features include:

- Overheat shut off • Residual hot surface indicator • All units are UL Listed and CE approved

- E. Force 10 Tobago 1 Burner Drop In** • (1) 6" burner
- F. Force 10 Grenade 2 Burner Drop In** • (2) 6" burners
- G. Force 10 Trinidad 3 Burner Drop In** • (3) 6" burners

	Item	Model	Heat Source	# of Burners	Burner	Amps	Ignition	Dimensions (W x D x H)	Cutout Dimensions (W x D x H)	Warranty (Years)	Ship	Net
<b>Drop-In, Slide-in and Built-in Cooktops</b>												
<b>C</b>	402186	432340015301	Propane	2	5,975/8,500 BTU	NA	Electronic	18.3" x 13.2" x 3.15"	See dimensional drawing at <a href="http://defender.com">defender.com</a>	2	9 lbs	\$309.99
<b>D</b>	402187	433340015301	Propane	3	3,414/5,975/8,500 BTU	NA	Electronic	18.3" x 15.15" x 3.15"	See dimensional drawing at <a href="http://defender.com">defender.com</a>	2	12 lbs	399.99
<b>Electric Cooktops – Please specify: 120 or 240 VAC</b>												M.A.P.
<b>E</b>	401535	F75121 (120 V) F75124 (240 V)	Electric	1	(1) 1,200 Watt	10 5	Electric	12" x 12" x 4.2"	10-9/16" x 10-9/16" x 2-7/8"	2	8 lbs	\$299.99
<b>F</b>	401536	F75221 (120 V) F75224 (240 V)	Electric	2	(2) 1,200 Watt	20 10	Electric	21" x 12" x 4.2"	19-9/16" x 10-5/8" x 2-15/16"	2	14 lbs	374.99 429.99
<b>G</b>	401537	F75321 (120 V) F75324 (240 V)	Electric	3	(3) 1,200 Watt	30 15	Electric	21" x 18" x 4.2"	19-9/16" x 16-5/8" x 2-15/16"	2	21 lbs 21 lbs	584.99

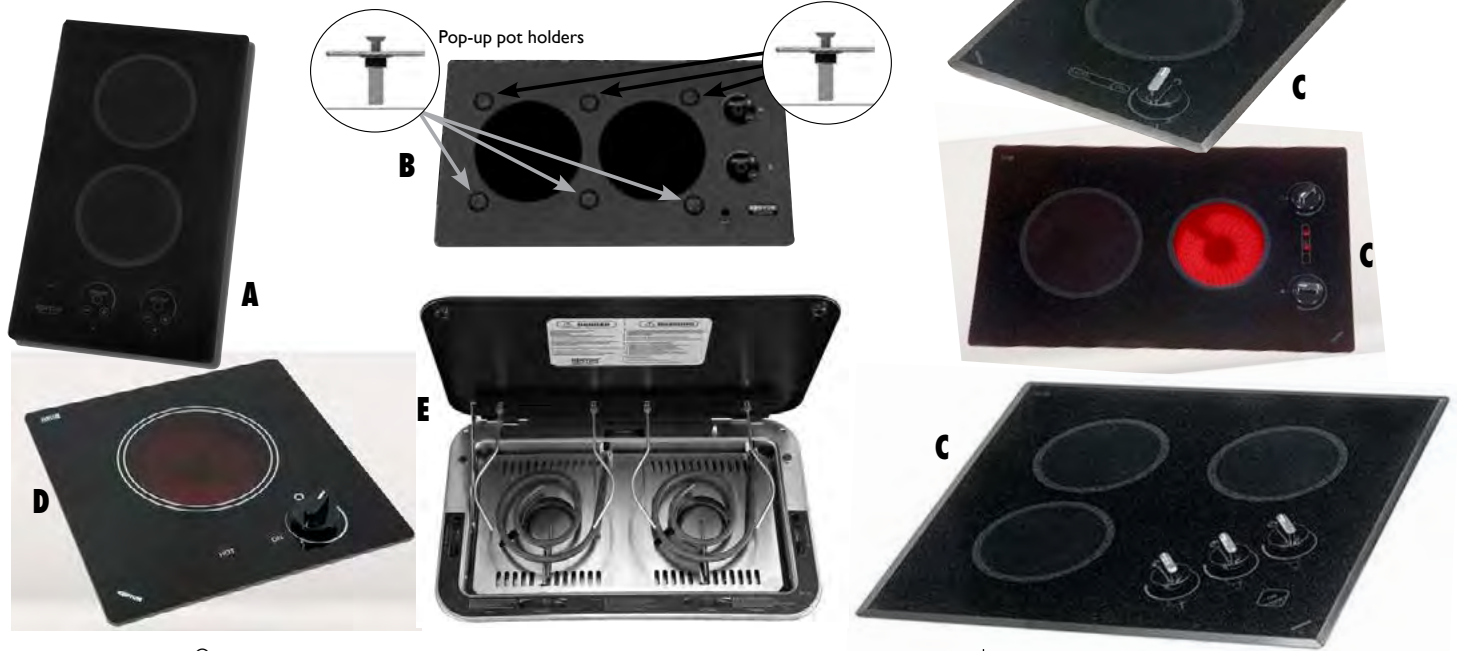

**A. KENYON LITE-TOUCH® Q 2 BURNER STOVE**

- Integrates the visual effect of knob control with the ease of touch
- Simply touch the ON/OFF circle and start cooking
- The ceramic glass slopes down to the counter with a mirror finish polished edge

Please specify voltage: 120 Volt AC or 240 Volt AC

**B. KENYON LITE-TOUCH TOP WITH PUPS**

- 2 Burner with (6) built-in, pop-up pot holders
- Please specify voltage: 120 Volt AC or 240 Volt AC

**C/D. KENYON MEDITERRANEAN AND CARIBBEAN**

- Quick to heat ribbon elements with infinite heat control
- Heat limiting cooking surface protectors
- ON indicator light for each burner
- HOT surface indicator light is packaged under the round edged ceramic glass top
- Smooth, easy-to-clean ceramic glass surface

Please specify voltage: 120 Volt AC or 240 Volt AC

**E. KENYON 1 & 2 BURNER ELECTRIC**

- UL Approved
- Rotating wheel controls burner
- Electric / alcohol cooking elements are provided
- Use the electric element as the grate for the alcohol burner
- Heat level adjusts with a separate adjustment wheel
- Provides a large cooking surface while taking up very little of your counter top
- The smooth rounded corners are easy to clean

Item	Model	Heat Source	# of Burners	Burner	Amps	Ignition	Overall Dimensions (W x D x H)	Cutout Dimensions (W x D x H)	Warranty (Years)	Ship	Net	
<b>C. Choose Portrait or Landscape and 120 Volt AC or 240 Volt AC</b>												
A	402225	Portrait	Electric	2	1200 (or) 1400 W and 1200 W	22/13	Electric	14.25" x 23.25" x 4.125"	21-3/4" x 12-3/4" (1/4" radius)	3	20 lbs	\$699.99
A	402226	Landscape	Electric	2		22/13	Electric	23.25" x 14.25" x 4.125"	21-3/4" x 12-3/4" (1/4" radius)	3	20 lbs	699.99
<b>D. Choose Portrait or Landscape and 120 Volt AC or 240 Volt AC</b>												
B	401983	Portrait/Landscape	Electric	2	1200/1200 W	20/10	Electric	21" x 12" x 4-1/8"	20" x 10 3/4" x 4-1/8"	3	20 lbs	\$714.99
C	402391	<del>B41517 120 VAC</del> B41518 240 VAC	Electric	1	1200 W	10/5	Electric	12-1/2" x 12" x 3-1/4"	11-1/2" x 10-3/4" x 3-1/4"	3	10 lbs	249.99
C	402389	<del>B41510 120 VAC</del> B41511 240 VAC	Electric	2	(8") 1400W/(6.5") 1200W (8") 1800W/(6.5") 1200W	20/10	Electric	14-1/4" x 23-1/4" x 3-1/4"	12-3/4" x 21-3/4" x 3-1/4"	3	20 lbs	374.99
C	402390	<del>B41515 120 VAC</del> B41516 240 VAC	Electric	2	(2) 6.5", 1200 W	22/13	Electric	21" x 12" x 3-1/4"	20" x 10-3/4" x 3-1/4"	3	15 lbs	349.99
C	<del>D 401960</del>	<del>B40508 120 VAC</del> B40509 240 VAC	Electric	3	1200 W	30/15	Electric	21-3/4" x 20-1/4" x 3-1/4"	19-9/16" x 18-1/16" x 3-1/4"	3	36 lbs	549.99
D	402396	<del>B41605 120 VAC</del> B41606 240 VAC	Electric	1	(6.5") 1200 W	10/5	Electric	12-1/2" x 12" x 3-1/4"	11-1/2" x 10-3/4" x 3-1/4"	3	11 lbs	209.99
D	402395	<del>B41601 120 VAC</del> B41602 240 VAC	Electric	2	(6.5") 1200 W	20/10	Electric	21" x 12" x 3-1/4"	20" x 10-3/4" x 3-1/4"	3	16 lbs	309.99
E	402241	B61144	Alcohol/Electric	1	1100 W	10	Electric	12.75" x 12.75" x 5.75"	12.25" x 12.25" (3" radius)	3	13 lbs	614.99
E	<del>D 402242</del>	B61148	Alcohol/Electric	2	1100 W	20	Electric	22.5" x 13.5" x 5.75"	21.75" x 12.75" (3" radius)	3	36 lbs	894.99



**Vacuum**

**DIRT DEVIL® CV1500 ALL-IN-ONE CENTRAL VACUUM SYSTEM**

- Captures dirt and debris in a central canister, keeping your boat cleaner and fresher
- Space-saving design is ideal for the limited space on boats and RVs
- Five year warranty
- Includes: 10" rug and floor tool, dusting brush, upholstery tool, crevice tool
- Adjustable, 1-piece telescoping wand
- Crushproof hose that expands 7' to 35'
- 3-Pack of HEPA filter bags
- Canister dimensions: 6.25" x 7" x 14.5"
- Power: 120 Volt AC / Max Amps: 11.7



Item	Model	Ship	Net
401643	CV1500	22 lbs	\$239.99

**Microwaves**

**MUAVE APPLIANCES COMPACT MICROWAVE OVEN**

- Capacity: 0.7 cubic feet • Cooking power: 700 Watts
- Voltage: 120 Volt AC (Requires 1050 watts input)
- Color: Stainless steel exterior wrap, Stainless and Black face

Item	Model	Ship	Net
402522	MU07120S	23 lbs	\$133.99



**MUAVE APPLIANCES MICROWAVE CONVECTION OVEN WITH TRIM KIT**

- Capacity: 1.0 cubic feet • Cooking power: 1000 Watts
- Cooking: convection, grilling and microwaving
- Voltage: 120 Volt AC (Requires 1500 watts input)
- Color: Stainless steel front with Black cabinet wrapper

Item	Model	Ship	Net
D402524	MUCMKT120S	62 lbs	\$406.99



**Washer/Dryer Laundry Centers**

**SPLENDIDE WASHER/DRYERS**

- Quiet, sound-absorbing materials; tri-phase motor
- Large, 11.5" door opening makes loading and unloading easier
- Redesigned vented drying system improves drying performance
- Power: 120 Volt AC; 60 Hz/11 A, 1300 W

Item	Model	Description	Dimensions	Ship	M.A.P.
400627	WD2100XC	White, vented	23-1/2" W x 33-1/8" H x 22-5/8" D	151 lbs	\$1299.00
400629	WDC7100XC	Platinum, ventless	23-1/2" W x 33-1/8" H x 22-5/8" D	200 lbs	Net 1409.99

- Easy-to-use controls use LED's to display cycle status
- Vented drying system improves drying performance with convenient auto dry cycles
- Unique "Add-An-Item" feature lets you add laundry during the cycle
- 1.92 cu. ft. drum



**Ice makers**

**RARITAN STAINLESS STEEL ICER-ETTE ICE MAKER - VOLTAGE: 115 VOLT AC/60 HZ NEW DOOR STYLE!**

- Flush mounted, built-in or freestanding. Includes flange • Produces up to 21 lbs of ice per day (stores up to 11 lbs)
- Only requires a 1/4" outside diameter water line • Approx cube Size: 1/2" W x 3/4" H x 2-1/2" L
- 5-year limited warranty • 2-year warranty on other parts • 5-year warranty on compressor



Item	Model	VAC	H x W x D (Cutout)	Cabinet/Door Finish	Output	Ship	Net
D 402597	87B515-1	115V / 60hz	25.4375" x 15.5" x 14.5" (24.625" x 15.25" x 14.375")	Stainless/Stainless	21 lbs/day	89 lbs	\$1144.99
D	87B515-2	230V / 50hz	25.4375" x 15.5" x 14.5" (24.625" x 15.25" x 14.375")	Stainless/Stainless	21 lbs/day	78 lbs	1154.99



**ISOTHERM WHITE ICE MAKERS – SPECIFY VOLTAGE: 115 VOLT AC/60 Hz or 230 VOLT AC/50Hz**

- Isotherm 5-year limited warranty • 5-year limited warranty on compressor
- 2-year limited warranty on other parts

Item	Model	VAC	H x W x D	Flange Style	Finish	Output	Ship	Net
402376	5W08A14IMN000	115	26" x 16.1" x 17.2"	Flush Mount	SS	22 lbs/day	75 lbs	\$1374.99
	5W08A11IMN000	230	26" x 16.1" x 17.2"	Flush Mount	SS	22 lbs/day	75 lbs	1374.99
402377	5W08A14CE0011	115	25.41" x 15.59" x 15.75"	Proud/Surface Mount	White	22 lbs/day	66 lbs	1204.99
	5W08A11CE0011	230	25.41" x 15.59" x 15.75"	Proud/Surface Mount	White	22 lbs/day	66 lbs	1224.99
402616	5W08L14IMN000	115	18.7" x 14.7" x 24.8"	Flush Mount	SS	22 lbs/day	75 lbs	1289.99
	5W08L14IEN000	115	18.7" x 14.7" x 24.8"	Proud/Surface Mount	SS	22 lbs/day	75 lbs	1289.99
	5W08L11IMN000	230	18.7" x 14.7" x 24.8"	Flush Mount	SS	22 lbs/day	75 lbs	1299.99
	5W08L11IEN000	230	18.7" x 14.7" x 24.8"	Proud/Surface Mount	SS	22 lbs/day	75 lbs	1299.99



**ISOTHERM CLEAR ICE MAKER**

- A spray-type ice maker that holds approximately 9 lbs of barrel shaped ice cubes in the insulated bin
- Can generate 40 lbs of crystal clear ice per day when connected directly to a pressurized water system
- Clear Ice is a denser ice that actually melts slower than ice cubes that are formed by pouring water into a mold
- Doesn't change flavor of drinks • The ice is always loose • Note: this unit requires a drain
- Isotherm 5-year limited warranty • 5-year limited warranty on compressor • 2-year warranty on other parts

Item	Model	H x W x D	Finish	Output	Ship	Starting at
402372	Specify voltage	22.9" H x 13.9" W x 16" D	Stainless steel	40 lbs/day	81 lbs	\$1609.99



**VITRIFRIGO HYDRO – F1/S1 BUILT-IN ICE MAKER – VOLTAGE: 115 VAC/60 Hz**

- 3-year limited warranty
- 3-year warranty on compressor
- 2-year warranty on other parts • Please specify: Flush mount or surface mount

Item	Capacity	H x W x D	Color	Output	Ship	Net
400812	0.8 Cu. Ft.	16-1/4" x 14-1/2" x 24-3/4"	Stainless steel; specify flush or surface mount	26 lbs/day	61 lbs	\$1054.99



**VITRIFRIGO BUILT-IN LOW PROFILE ICE MAKER – VOLTAGE: 115 VOLT AC/60 Hz**

- 3-year limited warranty
- 3-year warranty on compressor
- 2-year warranty on other parts

Item	Capacity	H x W x D	Color	Output	Ship	Net
400813	0.8 Cu. Ft.	22-1/8" x 14-5/8" x 18-3/4"	Stainless steel with flush flange (FI)	26 lbs/day	68 lbs	\$1114.99





**New Isotherm Design for Elegant, Energy-Efficient Refrigerators**



CR EL 49



SED00036DA



SED00033AA



CR 130 CT

Cruise Combi 195



CR 200



DR 49

DR 160

## Isotherm Refrigeration

### ISOOTHERM CRUISE ELEGANCE MARINE REFRIGERATORS

High performance and low power draw are critical in the marine environment. Cruise Elegance has extra thick insulation and a freezer design that reduces battery consumption resulting in superior performance.

- Ready for Isotherm Smart Energy Control (DC Models)
- Reversible door
- Compressors backed by Isotherm's 5-year limited warranty
- Blue LED internal lighting

Item	Door Trim/Panel	Voltage	H" x W" x D"	Ship	Starting at:
<b>CRUISE ELEGANCE 42 - 1.5 CU. FT.</b>					
D 402631	Black	Specify Voltage	20.67 x 15 x 19.6	57 lbs	<b>\$699.99</b>
D 402630	Silver	Specify Voltage		63 lbs	<b>854.99</b>
<b>CRUISE ELEGANCE 49 - 1.75 CU. FT.</b>					
D 402549	Black	AC/DC	20.67 x 15 x 19.6	63 lbs	<b>\$804.99</b>
D 402621	Silver	Specify Voltage		63 lbs	<b>924.99</b>
<b>CRUISE ELEGANCE 65 - 2.3 CU. FT.</b>					
D 402550	Black	AC/DC	20.89 x 17.67 x 20.4	69 lbs	<b>\$834.99</b>
D 402622	Silver	Specify Voltage		66 lbs	<b>974.99</b>
<b>CRUISE ELEGANCE 85 - 3.0 CU. FT.</b>					
D 402551	Black	AC/DC	24.67 x 18.67 x 21.6	71 lbs	<b>\$999.99</b>
D 402623	Silver	Specify Voltage		101 lbs	<b>1144.99</b>
<b>CRUISE ELEGANCE 130 - 4.6 CU. FT.</b>					
D 402552	Black	AC/DC	29.6 x 20.67 x 21.4	96 lbs	<b>\$1164.99</b>
D 402624	Silver	Specify Voltage		110 lbs	<b>1239.99</b>

### ENERGY SAVING KITS

- Reduces battery consumption by up to 50%

Item	Model	Description	Voltage Application	Ship	Net
401447	SED00033AA	Smart Energy Control Kit	DC only	1 lbs	<b>\$139.99</b>
402632	SED00036DA	Intelligent Temperature Control	AC/DC	2 lbs	<b>164.99</b>

### ISOOTHERM CRUISE CLEAN TOUCH STAINLESS STEEL MARINE REFRIGERATORS

Item	Clean Touch SS Model	Voltage	H" x W" x D"	Cu. Ft. Fridge/Freezer	Ship	Starting at
<b>CRUISE REFRIGERATORS with removable compressor (Take 6" off below depth dimension if Compressor is remote mounted)</b>						
D	402625	CR 42 CT	Please Specify	20.7 x 15.7 x 19.7	1.5 / .15	63 lbs <b>\$949.99</b>
D	402617	CR 49 CT	Please Specify	20.7 x 15 x 17.6	1.75 / .15	63 lbs <b>1059.99</b>
FR	402618	CR 65 CT	Please Specify	20.8 x 18.5 x 20.5	2.3 / .15	58 lbs <b>1074.99</b>
FR	402619	CR 85 CT	Please Specify	24.7 x 19.5 x 21.7	3.0 / .15	62 lbs <b>1144.99</b>
FR	402620	CR 130 CT	Please Specify	29.3 x 21.4 x 21.4	4.6 / .219	70 lbs <b>1379.99</b>

Item	Door Trim/Panel	Voltage	H" x W" x D"	Cu. Ft. Fridge/Freezer	Ship	Starting at
<b>CRUISE 130 DRINK - REFRIGERATOR ONLY (NO FREEZER SECTION)</b>						
FR	401033	Black	AC/DC	29.6 x 20.7 x 20.5	4.6 / NA	78 lbs <b>\$1409.99</b>
FR	400526	Stainless Steel	DC ONLY	29.6 x 20.7 x 20.5	4.6 / NA	75 lbs <b>1504.99</b>
FR	401034	Stainless Steel	AC/DC	29.6 x 20.7 x 20.5	4.6 / NA	74 lbs <b>1554.99</b>
<b>CRUISE COMBI 195 - REFRIGERATOR(TOP) / DEEP FREEZER (BOTTOM) 6.9 CU. FT.</b>						
FR	401035	Black	AC/DC	52.9 x 21.4 x 22.5	4.6 / 2.3	130 lbs <b>2184.99</b>
FR	401036	Stainless Steel	AC/DC	52.9 x 21.4 x 22.5	4.6 / 2.3	133 lbs <b>2554.99</b>
<b>CRUISE 200 CLASSIC MARINE REFRIGERATOR 7 CU. FT.</b>						
FR	400467	Black	AC/DC	34.7 x 28.9 x 24.3	5.2 / 1.8	115 lbs <b>2009.99</b>
FR	402160	Stainless Steel	AC/DC	34.7 x 28.9 x 24.3	5.2 / 1.8	118 lbs <b>2269.99</b>
<b>CRUISE UPRIGHT SILVER REFRIGERATORS 7.8-9.6 CU.FT.</b>						
FR	401037	CR219 Silver	AC/DC	57 x 21.7 x 21.5	6.6 / 1.5	99 lbs <b>\$1464.99</b>
FR	401038	CR271 Silver	AC/DC	65 x 21.7 x 20.5	7.7 / 1.9	115 lbs <b>1864.99</b>

### ISOOTHERM DRAWER REFRIGERATORS & FREEZERS

Item	Style	Voltage	H" x W" x D"	Cu. Ft. Fridge/Freezer	Ship	Starting at
<b>DRAWER 36 REFRIGERATORS</b>						
FR	402627	CR 36 Black	Specify Voltage	10 x 17.4 x 20.3	1.3 / NA	40 lbs <b>\$814.99</b>
FR	402628	CR 36 White	Specify Voltage	10 x 17.4 x 20.3	1.3 / NA	44 lbs <b>814.99</b>
<b>DRAWER STAINLESS STEEL</b>						
FR	402629	CR 36	Specify Voltage	10 x 17.9 x 21.7	1.3 / NA	43 lbs <b>\$1099.99</b>
FR	401041	DR 49	AC/DC	20.9 x 15.9 x 20.5	1.75 / .21	50 lbs <b>1529.99</b>
FR	400465	DR 65	AC/DC	20.9 x 18.5 x 21	2.3 / .28	70 lbs <b>1559.99</b>
FR	401540	DR 85	AC/DC	24.6 x 19.5 x 21.7	3.0 / .35	72 lbs <b>1679.99</b>
FR	401541	DR 130	AC/DC	29.3 x 21.4 x 21.4	4.6 / .53	94 lbs <b>1784.99</b>
<b>DRAWER 160 REFRIGERATORS &amp; FREEZERS - 5.5 CU. FT.</b>						
FR	402281	Fridge/Freezer	AC/DC	34 x 24.6 x 23.4	3.2 / 2.3	129 lbs <b>\$2649.99</b>
FR	402282	Fridge/Fridge	AC/DC	34 x 24.6 x 23.4	3.2 / 2.3	127 lbs <b>2299.99</b>
FR	402283	Freezer/Freezer	AC/DC	34 x 24.6 x 23.4	3.2 / 2.3	130 lbs <b>2599.99</b>

\* For optimal performance Smart Energy Control can be used on all Isotherm DC models.



Defender is the dealer of choice for premium refrigeration systems from Frigonautica. Please visit defender.com or call 800-628-8225 to special order.



## Isotherm Custom Refrigeration



### COMPACT COOLING UNITS

Isotherm compact refrigeration systems are pre-charged and easy to install. The reliable and efficient 12/24 VDC Danfoss compressor cools the evaporator fitted into your refrigerator or freezer box.

Choose from air or sea water cooled units to suit your cooling needs. Kits ship complete with mounting bracket, thermostat, compressor and electronics. Isotherm has support technicians who can be contacted by phone or email to answer any questions you may have.

Isotherm 5 year compressor limited warranty • 2 year warranty on parts



Air-cooled



Water-cooled self pumping – SP

Item	Model	Max Fridge Vol.	Max Freezer Vol.	Evaporator Dimensions"	Evaporator Shape	Compressor Dimensions"	Amps Power Consumption Max / Hourly	Danfoss Compressor Type	Temp Range	Ship	Net
<b>AIR-COOLED SYSTEMS</b>											
400520	2005	2.1	0.7	14 x 5	Flat	11 x 6 x 6	2.5 / .6	BD35F	Fridge or Freezer	20 lbs	\$819.99
401929	GE 80	2.8	0.9	14 x 10	Flat	11 x 6 x 6	2.5 / .6	BD35F	Fridge or Freezer	21 lbs	844.99
400519	2010	4.4	1.5	15.7 x 6.9 x 8.25	L-Shaped	11 x 6 x 6	2.5 / .7	BD35F	Fridge or Freezer	21 lbs	844.99
402558	2001	4.4	1.5	8.25 x 9.4 x 3.4	O-Shaped	11 x 6 x 6	2.5 / .6	BD35F	Fridge or Freezer	10 lbs	964.99
400516	2301	5.3	1.8	9.1 x 12.6 x 3.9	O-Shaped	11 x 6 x 6	3.5 / .7	BD35F	Fridge or Freezer	21 lbs	954.99
402581	GE 150	5.3	1.8	15 x 14	Flat	11 x 6 x 6	3.5 / .7	BD35F	Fridge or Freezer	11 lbs	864.99
401451	VE 150	5.3	None	10.8 x 8.4 x 2.3	Fin	12 x 6 x 6	3.5 / .7	BD35F	Fridge	19 lbs	694.99
401450	2012	6	2	32 x 8	Flat	12 x 6 x 6	4.5 / .9	BD50F	Dual	25 lbs	979.99
D 400517	2501	7.1	2.3	10.6 x 15 x 5.5	O-Shaped	12 x 6 x 6	3.5 / .9	BD50F	Fridge or Freezer	30 lbs	1039.99
D 401051	2016	7.1	2.3	47 x 7	Flat	12 x 6 x 6	6 / 1	BD50F	Dual	57 lbs	999.99
401052	2017	9.2	3	39 x 11	Flat	12 x 6 x 6	6 / 1.1	BD50F	Dual	26 lbs	1094.99
400521	2013	14.1	4.7	54 x 12	Flat	12 x 6 x 6	6 / 1.2	BD50F	Dual	27 lbs	1109.99

**AIR-COOLED SYSTEM KITS** These new kits include all the components of the air-cooled systems above PLUS the Smart Energy Controller (Item 401447)

402491	GE80-SX	2.8	0.9	14 x 10	Flat	11 x 6 x 6	2.5 / .3*	BD35F	Fridge or Freezer	20 lbs	\$869.99
402493	2010-SX	4.4	1.5	15.7 x 6.9 x 8.25	L-Shaped	11 x 6 x 6	2.5 / .35*	BD35F	Fridge or Freezer	21 lbs	864.99
D 402494	2013-SX	14.1	4.7	54 x 12	Flat	12 x 6 x 6	6 / 1.2*	BD50F	Dual	52 lbs	1089.99

\* Hourly amp figures based on system reaching economy mode temperatures

**WATER-COOLED SYSTEMS**

**SP Thru-Hull Systems** • SP system reduces the noise of a ventilated condenser and reaches a very low power consumption

401773	2051	4.4	1.5	9 x 3 x 8	O-Shaped	8 x 5 x 6	2.5 / .6	BD35F	Fridge or Freezer	25 lbs	\$1064.99
401452	2050	4.4	1.5	16 x 7 x 8	L-Shaped	8 x 5 x 6	3.5 / .7	BD35F	Fridge or Freezer	25 lbs	1064.99
401774	2351	5.3	1.8	13 x 4 x 9	O-Shaped	8 x 5 x 6	3.5 / .7	BD35F	Fridge or Freezer	25 lbs	1114.99
D 401053	2553	6	2	32 x 8	Flat	8 x 5 x 6	4.5 / .9	BD50F	Dual	73 lbs	1244.99
D 401775	2551	7	2.3	15 x 6 x 11	O-Shaped	8 x 5 x 6	4.5 / .8	BD50F	Fridge or Freezer	31 lbs	1219.99
401055	2555	9.2	3	39 x 11	Flat	8 x 5 x 6	6 / 1	BD50F	Dual	31 lbs	1274.99
401453	2556	14.1	4.7	54 x 12	Flat	8 x 5 x 6	6 / 1.1	BD50F	Dual	35 lbs	1314.99

**MAGNUM SEA WATER PUMP SYSTEMS** • High capacity up to 600 liter refrigerators • Self-priming sea water pump to ensure extra high efficiency for tropical applications • Variable speed water pump is controlled by the temperature of condenser

402378	2511	6	2	32 x 8	Flat	17 x 9 x 7	4.5 / 1	BD50F	Dual	37 lbs	\$1364.99
401056	2505	7.1	2.3	15 x 6 x 11	O-Shaped	17 x 9 x 7	6 / 1	BD50F	Dual	29 lbs	1444.99
402379	2512	7.1	2.3	47 x 7	Flat	17 x 9 x 7	6 / 1.1	BD50F	Dual	37 lbs	1384.99
D 402380	2513	9.2	3	39 x 11	Flat	17 x 9 x 7	6 / 1.1	BD50F	Dual	52 lbs	1409.99
D 401057	2507	14.1	4.7	54 x 12	Flat	17 x 9 x 7	6 / 1.4	BD50F	Dual	57 lbs	1474.99

### Isotherm ITC: Save Energy on Board!

ITC technology detects when a surplus of power is available and uses it to freeze the cooling plate. This method of refrigeration is used to achieve unbeatable power savings. ITC Digital Controller included.

Item	Model	Max Volume	Holding Plate Dimensions"	Compressor Dimensions"	Amps Power Consumption Max / Hourly	Danfoss Compressor Type	Temp Range	Ship	Net
<b>AIR-COOLED ITC EUTECTIC HOLDING PLATE SYSTEMS</b>									
402786	3201	4.4	12 x 8 x 2.4	11 x 6 x 6	5 / .4	BD35F	Fridge	31 lbs	\$1399.99
402787	3701	7.1	14 x 11 x 2.4	12 x 6 x 6	6 / .6	BD50F	Fridge	36 lbs	1524.99
<b>SEA WATER-COOLED ITC EUTECTIC HOLDING PLATE SYSTEMS</b>									
402788	3251	4.4	12 x 8 x 2.4	8 x 5 x 6	5 / .4	BD35F	Fridge	33 lbs	1654.99
402789	3751	7.1	14 x 11 x 2.4	8 x 5 x 6	6 / .5	BD50F	Fridge	38 lbs	1664.99
402790	4201	7.1	14 x 11 x 2.4	15 x 8 x 7	6.5 / .9	BD50F	Fridge	45 lbs	2054.99
402791	4701	8.5	14 x 11 x 3.6	15 x 8 x 7	6.5 / 1	BD50F	Fridge	48 lbs	2324.99

Note: Universal kit AC/DC optional for complete power supply compatibility (12/24 VDC 230/115 VAC and 50/60 Hz)

### Travel Boxes

Isotherm 5 year compressor limited warranty • 2 year warranty on parts • The entire range of Isotherm travel boxes has a dual-speed function and digital control of the compressor: MAX mode and ECO mode. In MAX mode, the compressor runs at a high speed for fast cooling. In ECO mode, the compressor runs at a slower speed for greater economy and energy efficiency.

Item	Model	Voltage	Volume Cubic Feet	Danfoss Compressor	Dimensions	Operation°	Ship	Net
402398	TB18	12/24 VDC	.64	BD1.4F	22"L x 9.2"W x 16"H	50-0° F	22 lbs	\$674.99
402273	TB31	AC/DC	1.1	BD35F	23"L x 14"W x 15"H	50-0° F	39 lbs	754.99
402274	TB41	AC/DC	1.4	BD35F	23"L x 14"W x 17.5"H	50-0° F	45 lbs	849.99
D 402276	TB51	AC/DC	1.8	BD35F	21"L x 13.8"W x 20.9"H	50-0° F	45 lbs	874.99



Air-cooled ITC



Water-cooled self pumping – ITC SP



TB-31



### SMART ENERGY CONTROL KIT

- Reduces battery consumption up to 50%
  - Compatible with DC Models ONLY
- Item 401447  
Model SED00033AA  
Ship 1 lbs  
Net \$139.99

All Indel refrigeration systems operate on 12/24 VDC.



### ISOETHERM DIGITAL DISPLAY INTELLIGENT TEMPERATURE CONTROL

- Item 402632  
Model SED00036DA  
Ship 2 lbs  
Net \$164.99

COOLMATIC 80 SERIES BY DOMETIC – FOR UP TO 8.8 CU. FT.



A CU-86

**A. COOLMATIC 80 SERIES CONDENSING UNITS**

Use with any of the 80 series evaporators to turn any insulated space - up to 8.8 cubic feet - into a customized refrigerator. The CU-84, 85 and 86, while varying in shape, offer the same powerful performance. Condensing units can be mounted up to 6.5' from evaporator.

Item	Model	W" x D" x H"	Voltage	Compressor	Ship	Net
401830	CU-84	15.2 x 5.1 x 6.1	12/24 VDC	Danfoss BD35F	16 lbs	\$844.99
401831	CU-85	8.7" x 8.7" x 6.1"	12/24 VDC	Danfoss BD35F	16 lbs	844.99
401832	CU-86	8.7" x 7.6" x 9"	12/24 VDC	Danfoss BD35F	17 lbs	844.99

At 12 VDC: 5.7 amps starting, 1.5 amps running

At 24 VDC: 7.9 amps starting, 2.9 amps running

B VD-09



**B. COOLMATIC 80 SERIES EVAPORATING UNITS**

Each evaporator comes with 6.5' copper tube set and quick disconnect couplings for easy installation, thermostat assembly with 9' wire harness and installation instructions.

Item	Model	Cu. Ft. Capacity	W" x D" x H"	Plate Configuration	Ship	Net
401833	VD-04	4.5	3.9 x 14.8 x 10	L-shaped	4 lbs	\$234.99
401834	VD-05	4.6	1 x 14.8 x 13.7	Flat	4 lbs	234.99
401835	VD-08	5.7	10.6 x 13.4 x 17.7	L-shaped	7 lbs	334.99
401836	VD-09	5.7	10.6 x 14.4 x 5.5	O-shaped	5 lbs	299.99
401837	VD-15	7.0	2.6 x 8.6 x 10.8	Circulating air	5 lbs	199.99



C CS-NC-15

**C. DOMETIC DO-IT-YOURSELF COOLING KIT – Ideal for converting an existing passive, insulated coolbox into a full refrigerator.**

- Cut an opening in the side of the coolbox and push the unit into the adjoining section
- Fasten it from the inside to the evaporator housing using the pre-cut assembly holes
- An integrated rubber seal ensures that the coolbox is securely sealed. No need to lay any coolant pipes at all!

Item	Model	Dimensions D" x W" x H"	Amps	Compressor	Cools	Ship	Net
401988	CS-NC-15	9 x 10 x 14	4.0	Danfoss BD35F	8.8 cu. ft.	22 lbs	\$789.99

THE COLDMACHINE™ 100 SERIES BY DOMETIC – FOR UP TO 15 CU. FT.

A



CU-100

**A. DOMETIC 100 SERIES CONDENSING UNITS (FORMERLY ADLER BARBOUR)**

Use with any of the 100 series evaporators to turn any insulated space - up to 15 cubic feet - into a customized refrigerator. Features: Oversized air and optional water condensers for top performance in the most severe tropical temperatures with 3" of polyurethane insulation and deep-freezing applications up to approximately 6 cubic feet with 4" of insulation.

Item	Model	D" x W" x H"	VDC	Compressor	Ship	Net
402231	CU-100 ColdMachine - Air cooled	11.1 x 10 x 7.5	12/24	Danfoss BD50F	20 lbs	\$824.99
402232	CU-200 Super ColdMachine - Air/water cooled	11.1 x 10 x 7.5	12/24	Danfoss BD50F	19 lbs	1034.99

At 12 VDC: 7.9 amps starting, 2.9 amps running

At 24 VDC: 5.7 amps starting, 1.5 amps running

B



FI701

**B. DOMETIC 100 SERIES EVAPORATING UNITS (FORMERLY ADLER BARBOUR)**

When choosing your evaporator, take into consideration both the installation conditions and your performance requirements. Dometic condensing units and evaporators feature self-sealing, quick-connect fittings for easy attachment.

Item	Model	Cu. Ft. Capacity	W" x H" x D"	Plate Configuration	Ship	Net
402233	VD-150	9	10.5 x 11 x 6	O-shaped - vertical	11 lbs	\$489.99
402234	VD-151	9	10.75 x 7 x 11.25	O-shaped - horizontal	9 lbs	489.99
402235	VD-152	15	15 x 12 x 6	O-shaped - vertical	14 lbs	594.99
402236	VD-153	15	15.5 x 7.5 x 12	O-shaped - horizontal	11 lbs	594.99
400469	FI701		Verticube ice tray with grid		2 lbs	84.99
402237	VD-160	4	19 x 11.25 x 1.25	Holding plate	23 lbs	1524.99

C



CRX-1050U

**C. CRX SERIES BUILT-IN REFRIGERATOR/FREEZER**

- Removable freezer compartment transforms the unit into a full refrigerator or freezer
- Interior mounted electronic thermistor for accurate temperature measurements
- Includes flush-mount flange\*

Item	Model	Color	W" x H" x D"	Capacity	VDC	VAC	Ship	Net
401636	CRX-1050U/F	Black	15.25 x 21.125 x 17.5	1.6 cu. ft.	12/24	110	59 lbs	\$824.99
401637	CRX-1065U	Black	18 x 20.75 x 19.25	1.9 cu. ft.	12/24	110	65 lbs	899.99
401638	CRX-1080U	Black	19 x 25.25 x 18.75	2.6 cu. ft.	12/24	110	72 lbs	974.99
401639	CRX-1110U	Black	20.75 x 29.375 x 19.75	3.8 cu. ft.	12/24	110	85 lbs	1084.99
402566	CRX-1050S	Stainless steel	Size will vary depending on flange type*	1.6 cu. ft.	12/24	110/220	59 lbs	1054.99
402567	CRX-1065S	Stainless steel		1.9 cu. ft.	12/24	110/220	65 lbs	1134.99
402568	CRX-1080S	Stainless steel		2.6 cu. ft.	12/24	110/220	72 lbs	1209.99
402569	CRX-1110S	Stainless steel		3.7 cu. ft.	12/24	110/220	74 lbs	1209.99

\*Flush mount flange included with black CRX models. Flush or space saver flange sold separately for SS units.

D



CRD-1050S

**D. DOMETIC CRD-1050 DRAWER REFRIGERATOR**

- Removable freezer compartment transforms the unit into a full refrigerator or freezer
- Powered by a fully hermetic Secop compressor with integrated control electronics
- Wire brackets set in the drawer frame keep beverage bottles upright and secure
- Door lock's venting mechanism holds door open slightly for easy defrosting and mildew prevention

Item	Model	Color	Flush Mount Flange	W" x H" x D"	Capacity	VDC	VAC	Ship	Net
402368	CRD-1050U	Black	Included	14.96 x 21.02 x 19.68	1.76 cu. ft.	12/24	110/220	63 lbs	\$1054.99
402369	CRD-1050E	Silver	Included	14.96 x 21.02 x 19.68	1.76 cu. ft.	12/24	110/220	63 lbs	1054.99
402496	CRD-1050-S-B	SS	Sold separately	14.976 x 21.3 x 19.69	1.65 cu. ft.	12/24	110/220	63 lbs	1199.99



## Vitrifigo Refrigerators

### VITRIFRIGO BUILT-IN DRAWER REFRIGERATOR

#### VITRIFRIGO AC/DC Internal Cooling

12/24 VDC - 115/230 VAC, 60/50 Hz, Black Face, Adjustable Flange

Vitrifigo refrigerators with internal cooling units are easy to install because the cooling unit is mounted directly onto the refrigerator cabinet. These units are recommended in all applications where there is sufficient ventilation around the refrigerator, especially behind it, near the cooling unit.



Item	Model	Refrig. Cu. ft.	Freezer Cu. ft.	Cutout H" x W" x D"	Ship	Net
<b>Black Refrigerator</b>						
401786	C511BD4-F-1	1.8	0.1	20-7/8 x 15-9/16 x 20-1/4	43 lbs	\$754.99
400804	C621BD4-F-1	2.2	0.16	20-7/8 x 18-7/16 x 20-7/8	47 lbs	769.99
401671	C851BD4-F-1	2.8	0.4	31-3/16 x 19-13/16 x 18-1/8	71 lbs	856.99
401664	C1151BD4-F-1	4.2	0.6	30-3/16 x 21-3/8 x 21-3/4	80 lbs	1000.99
<b>Stainless Steel Refrigerator</b>						
401509	C511XD4-F-1	1.8	0.1	20-7/8 x 15-9/16 x 20-1/4	48 lbs	864.99
402595	C621XD4-F-1	2.0	0.2	20-7/8 x 18-7/16 x 20-7/8	53 lbs	874.99
402596	C851XD4-F-2	2.8	0.4	31-1/8 x 19-13/16 x 18-1/16	68 lbs	1099.99
401670	C1151XD4-F-1	3.6	0.6	30-3/16 x 21-1/4 x 21-3/4	75 lbs	1119.99
<b>Black Double Door Refrigerator - 8.1 Cu. Ft.</b>						
400806	DP2600IBD4-F-2	6.0	2.1	52-15/16 x 23-7/16 x 23-11/16	135 lbs	1534.99
<b>Stainless Steel Double Door Refrigerator - 8.1 Cu. Ft.</b>						
401915	DP2600IXD4-F-2	6.0	2.1	52-15/16 x 23-7/16 x 23-11/16	136 lbs	1744.99



C51i

DP2600i



C115iAC



DW180RFXAC  
DW180DTXAC



DW70RFXAC

### VITRIFRIGO BUILT-IN DRAWER REFRIGERATOR AND FREEZER

#### AC/DC Surface Mount, Stainless Steel, 12/24 VDC - 115/230 VAC, 60/50 Hz

The Sea Drawer refrigerator and freezer range gives you the opportunity to choose the configuration that best suits your needs. The elegant design, Stainless Steel finish and higher capacity place these above others currently on the market.

Item	Model	Refrig. Cu. ft.	Freezer Cu. ft.	Cutout H" x W" x D"	Ship	Net
<b>Drawer Refrigerator, External cooling</b>						
400808	DW70RXP4-ES-1	2.6	-	17-11/16 x 24-5/16 x 22-13/16	74 lbs	\$1289.99
<b>Drawer Freezer, External Cooling</b>						
400809	DW70RXN4-ES-1	-	2.6	17-11/16 x 24-5/16 x 22-13/16	78 lbs	1419.99
<b>Double Drawer Refrigerator, Internal cooling</b>						
400810	DW180IXP4-ES-1	(2.3 + 2.8)	-	33-11/16 x 24-5/16 x 21-5/8	115 lbs	1914.99
<b>Double Drawer Refrigerator/Freezer, Internal cooling</b>						
400811	DW180IXD4-ES-1	2.3	2.8	33-11/16 x 24-5/16 x 21-5/8	120 lbs	2019.99

## Norcold Refrigerators

### NORCOLD NR AC/DC MARINE REFRIGERATORS . . . . . 120VAC-0.75AMP 12VDC 3.6AMP 24VAC 1.8AMP

- Self-ventilated design for easy integration
- Proud or flush mount capability standard
- New "hidden" ventilation grill
- Positive center-locking latch and reversible doors
- New side mount - no visible fasteners in front
- NR740 and NR751 replace DE740 and DE751 models
- Danfoss BD35 compressor
- New Cool Blue LED interior light



Item	Model	Cu. Ft.	Cutout	Color	Ship	Net	
D 401272	NR740BB*	1.7	20.5" H x 15.25" W x 17.84" D	Black	50 lbs	\$829.99	
D 401273	NR740SS*	1.7	20.5" H x 15.25" W x 17.84" D	Stainless Steel	50 lbs	979.99	
D 401274	NR751BB*	2.7	20.5" H x 18.5" W x 21.06" D	Black	68 lbs	874.99	
D 401275	NR751SS*	2.7	20.5" H x 18.5" W x 21.06" D	Stainless Steel	68 lbs	1024.99	
401276	*120 VAC US power cord required for AC operation					1 lbs	28.99
401277	*230 VAC European/Australian power cord required for AC operation					1 lbs	44.99



NR740SS



DE0788B

### DE0788B REFRIGERATOR - 3.1 CUBIC FEET . . . 120 VAC/0.8 A, 12 VDC/3.0 A, 24 VDC/1.5 A

- Free-standing with mounting legs
- Full-width freezer compartment
- Quiet, hermetically-sealed compressor

Item	Model	Cutout	Color	Ship	Net
402196	DE0788B	30" H x 20.5" W x 20.125" D	Black	81 lbs	\$1154.99

### DE0041 - 3.6 CUBIC FEET. . . . . 120VAC/0.8A 12VDC/5.4A 24VDC/2.2A

- Contemporary Flushmount™ styling
- Convenient top-mounted controls
- Quiet, hermetically-sealed compressor
- Improved cooling in higher temperatures
- Self-ventilated design for easy integration
- Door panel sold separately

Item	Model	Cutout	Color	Ship	Net
401931	DE0041 R/L	30.875" H x 23.25" W x 23.5" D	Black	88 lbs	\$1084.99
401951	623866	Black door panel for DE0041		3 lbs	35.99



DE0041 R/L

### DE0061 - 5.3 CUBIC FOOT REFRIGERATOR AND 1.7 CUBIC FOOT FREEZER . . . . . 120VAC/0.4A 12VDC/3.2A 24VDC/2.2A

- Self-ventilated design for easy integration
- Convenient top-mounted controls
- Door panel sold separately

Item	Model	Cutout	Color	Ship	Net
401930	DE0061R	52.875" H x 23.25" W x 23.75" D	Black	128 lbs	\$1424.99
401937	623867	Black door panels for DE0061		5 lbs	47.99

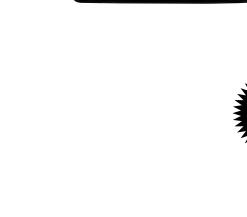

2 Year warranty



2 Year warranty

### NORCOLDER® AC/DC CONVERSION KITS

- Converts insulated ice box into an automatic electric refrigerator
- Includes single compressor and evaporator, power ventilation package, temperature control and 12' of copper tubing for placement of compressor/power supply away from evaporator plate

Item	Model	Configuration	Capacity	Ship	Net
401469	SCQT4408F-L	L-shaped evaporator plate	Cools up to 6 cubic feet	30 lbs	\$754.99
401470	SCQT4408F-I	I-shaped (flat) evaporator plate	Cools up to 3 cubic feet	30 lbs	754.99

SCQT4408F-I (Flat Plate)



SCQT4408F-L (L-Shaped plate)

### Miscellaneous Galleyware

#### JAVA POLYCARBONATE COFFEE PRESS

- Maintains the ideal temperature during brewing
- Unbreakable
- Easy to clean

Item	Model	Capacity	Ship	Net
402062	4635	13 oz.	1 lbs	\$11.99



#### SUITCASE DISHRACK

- Holds (13) plates, flatware, mugs and bowls
- When closed, it resembles a suitcase
- Measures roughly 12" x 8" x 2"

Item	Model	Open Footprint	Ship	Net
402001	4604	12" x 16-1/2"	3 lbs	\$20.99



#### CAMCO MINI DISH DRAINER

- Drain tray snaps on top of rack for handy storage

Item	Model	Dimensions	Ship	Net
400929	43511	9.5" x 11.69" x 4.75"	2 lbs	\$7.59



#### CAMCO WALL MOUNT TRASH BIN

- Compact trash can mounts to wall or inside a cabinet
- Includes swing-top lid and mounting bracket with screws

Item	Model	Dimensions	Ship	Net
402265	43961	11" H x 8.75" W x 5" D	2 lbs	\$15.99



#### LEWMAR BABY DELTA ANCHOR BOTTLE OPENER

- Mirror-polished stainless steel

Item	Model	Dimensions	Ship	Net
400957	B10503	4"L x 2"W x 1-1/2"H	1 lbs	\$19.99



### Galleyware Nesting Cookware

Hybrid

Teflon Coated



#### GALLEYWARE PRO NESTING STAINLESS STEEL COOKWARE COMMERCIAL QUALITY COOKWARE SETS

NOW Suitable for Use on Induction Cooktops!

- 18/10 stainless steel
- Encapsulated aluminum base

##### 14-Piece Sets include:

- 1-1/2 Qt. saucepan
- 5 Qt. Dutch oven
- Bungee storage cord
- (2) New and improved removable handles
- 2 Qt. saucepan
- (4) plastic storage lids
- (1) large and (1) small multi-lid
- 3 Qt. saucepan
- 9-1/2" diameter sauté pan

Item	Model	Interior coating	Ship	Net
401627	C9601	Stainless steel	12 lbs	\$132.99
401628	C9603	Hybrid, stainless with Teflon™ coated	12 lbs	140.99
401629	C9605	sauté pan and coated 1-1/2 and 2 quart saucepan	12 lbs	167.99

### Magma Nesting Cookware Sets & Accessories

#### 7 Piece Sets include:

- 10" Dia. skillet/fry pan
- 5 Qt. stock pot
- Stock pot/skillet lid
- 2 Qt. sauce pan
- Universal sauce pan lid
- (1) Removable handle
- "Bungee" storage cord

#### 10 Piece Sets include: all of the above plus

- 1-1/2 Qt. sauce pan
- 3 Qt. sauce pan
- Second removable handle

Standard models: Suitable for use on standard gas, electric, glass ceramic cook tops

Induction models: Suitable for use on standard gas, electric, glass ceramic or induction cook tops

#### 7 Piece Sets

Item	Model	Type	Interior coating	Exterior	Ship	Net
402221	A10-362	Standard	No coating	SS	10 lbs	\$137.99
402527	A10-362-IND	Induction	No coating	SS	11 lbs	137.99

#### 10 Piece Sets

Item	Model	Type	Interior coating	Exterior	Ship	Net
401379	A10-360L	Standard	No coating	SS	14 lbs	\$177.99
402528	A10-360L-IND	Induction	No coating	SS	13 lbs	177.99
401630	A10-366-2	Standard	Ceramica®	SS	15 lbs	219.99
401632	A10-366-2-IND	Induction	Ceramica	SS	14 lbs	219.99
401631	A10-366-CB-2	Standard	Ceramica	Cobalt Blue	15 lbs	239.99
401633	A10-366-CB-2-IND	Induction	Ceramica	Cobalt Blue	14 lbs	227.99

Other Magma Cookware sets available by Special Order at [www.defender.com](http://www.defender.com)

### Drinkware

#### RONSTAN DRINK HOLDER- Ships 1 lbs

- Hook and loop fixing, with sticky back
- Durable, water repellent, UV resistant
- Easy to mount - no drilling
- Acrylic with mesh bottom

Item	Model	Size	Color	M.A.P.
601388	RF3751	5-1/8" x 5-1/8" x 3-9/16"	Navy	\$15.95



#### ONGARO STAINLESS STEEL DRINK HOLDERS- All ship 1 lbs

Item	Model	W x H	Flange	Hole Size	Net
402103	60012	3-1/2" x 2-3/4"	1/4"	3"	\$8.99

#### With Drain and Plug

401936	60002	4-1/4" x 3-1/2"	3/8"	3-1/2"	\$15.99
--------	-------	-----------------	------	--------	---------



#### SEA-DOG GIMBALED CHROME PLATED BRASS DRINK HOLDERS

- Quick-release bracket
- (2) Wall brackets and fasteners
- Fits most mugs with handles, cans/glasses
- Foam insulator included

Item	Model	W x H	Ship	Net
400256	588130-3	3-1/2" x 3-3/4"	1 lbs	\$10.99



#### TACO POLY DRINK HOLDERS

- White UV-stabilized high density polyethylene
- Withstands marine environment
- Mounting hardware not included

#### 2 Cup and catch all- 16-1/4" W x 5-1/4" D x 3-1/4" H

Item	Model	Ship	Net
401261	P01-2000W	4 lbs	\$45.99

#### 2 Cup holder- 9-7/8" W x 4-3/4" D x 3-1/2" H

Item	Model	Ship	Net
401262	P01-2001W	2 lbs	\$35.99

#### 1 Cup holder- 4-5/8" W x 4-3/4" D x 3-1/2" H

Item	Model	Ship	Net
401263	P01-2003W*	1 lbs	\$27.99

\* With suction cups for mounting or can mount with screws (not included)



#### BLUE PERFORMANCE RAIL MOUNT OR LIFE LINE MOUNT DRINK HOLDER

- Material: Gray ripstop. Holds two drinks

Item	Model	Description	Ship	Net
608897	BP3660	Rail mount drink holder	1 lbs	\$29.99



#### TACO MARINE POLY TUMBLER HOLDER

- Material: UV-stabilized high density Polymer
- Color: White or Black
- Includes mobile device cutout and charging cable port

Item	Model	Description	Ship	Net
401780	P01-2010	Single cup holder	1 lbs	\$20.00
	P01-2020	Double cup holder	2 lbs	30.00



#### WHITE WATER RECESSED DRINK HOLDER INSERT

- Mount: Flush, self-adhesive gasket under rim
- Includes nylon hose barb for 3/8" hose
- Cutout: 3-1/2", Material: Drawn 304 Stainless Steel

Item	Model	Description	Ship	Net
401735	56228S	Drink holder insert	1 lbs	\$11.99



#### ZARCOR UNIVERSAL DRINK HOLDER

- Mounting hardware included, gimbaled with a wing nut clamp

Item	Model	Description	Ship	Net
401762	UDH-01	Universal drink holder	1 lbs	\$21.99



#### ZARCOR UNIVERSAL WINEGLASS HOLDER

- Mounting hardware included, gimbaled with a wing nut clamp

Item	Model	Description	Ship	Net
401795	UWH-01	Drink holder for stemware only	3 lbs	\$12.99



7 Piece Set



10 Piece Set



#### Accessories

Item	Model	Pieces	Interior coating	Exterior	Ship	Net
401381	A10-367	(1) Colander, 5 Qt.	SS	SS	3 lbs	\$32.99
401640	A10-369-2	(1) Omelette/sauté pan	Ceramica	SS	3 lbs	42.99
401641	A10-369-2-IND	(1) Omelette/sauté pan	Ceramica	SS	3 lbs	42.99
401634	10-361	Replacement handle			1 lbs	28.99
402587	A10-364	Padded storage/carry case			1 lbs	28.99



## Galleyware Melamine Dinnerware

- Break and scratch resistant melamine
- High-gloss finish
- Plates and bowls have non-skid bottoms
- Dishwasher safe and microwave safe (up to 1 minute)

### 16, 24 and 32 Piece Boxed Sets

- **16 piece set contains:**  
(4) 10" dinner plates, (4) 8" salad plates, (4) soup bowls\* and (4) 12 oz. coffee mugs
- **24 piece set contains:**  
(6) 10" dinner plates, (6) 8" salad plates, (6) soup bowls\* and (6) 12 oz. coffee mugs
- **32 piece set contains:**  
(8) 10" dinner plates, (8) 8" salad plates, (8) soup bowls\* and (8) 12 oz. coffee mugs

# of Pieces	Ship	Net
16 piece	8 lbs	\$97.99
24 piece	12 lbs	142.99
32 piece	15 lbs	189.99

Item	Pattern
401158	Offshore
401157	Great Oceans
401471	Anchorline
401473	Black Compass
401765	Coral
401474	Flags
401162	Commodore
401487	Ocean Breeze
401489	Gold Fish
401472	Life Preserver
401475	Blue Compass
401766	Rope

# of Pieces	Ship	Net
16 piece	8 lbs	\$77.99
24 piece	12 lbs	114.99
32 piece	14 lbs	152.99

### SOLID COLOR MELAMINE DINNERWARE

Item	Color
401160	White
401161	Navy Blue
402562	Salmon

\* Decorated come with 20 oz. soup bowls. Solid color sets come with 16 oz. bowls.

SEE DEFENDER.COM for additional patterns and single piece options!

## Mugs

### CERAMIC MUG WITH LID

- Non-skid
- Microwave safe

**Specify:** Marlin, Coral, Grand Slam, Desert Isle or Jolly Roger

Item	Size	Ship	Net
400884	16 oz.	2 lbs	\$10.99



## Drinkware, Tumblers, Pitchers & Ice Bucket

### STRAHL UNBREAKABLE DRINKWARE – All ship 1 lbs\*

- \* Ice bucket Ships 2 lbs
- Freezer, microwave and dishwasher safe
- Guaranteed unbreakable • Lifetime warranty
- High-end FDA approved polycarbonate

Item	Model	Description	Net
401397	5101	8 oz., Stemless wine	\$11.99
400883	5100	13 oz., Stemless wine	13.99
400878	5205	8 oz., Wine	11.99
400879	5211	10 oz., Wine	12.99
400882	5253	Ice bucket, 6-3/4" x 6 -1/2"	42.99
Item	Description	Net	
401164	10 oz. Clear tumbler	\$10.99	
402356	Pitcher, 1.5 liters	39.99	

### REGATTA STACKING DRINKWARE – All ship 1 lbs\*

- Top rack dishwasher safe

Item	Model	Description	Net
402350	DB 3	10 oz., Tumbler	\$8.99
402351	DB 4	13 oz., Tumbler	9.99
402352	DB 7	16 oz., Pint glass	9.99

### POLYCARBONATE DRINKWARE

- Top rack dishwasher safe

Item	Model	Description	Net
402348	5377	22 oz., Square tumbler	\$4.99
401992	5002	16 oz., Brandy snifter	5.99

### ACRYLIC DRINKWARE– All ship 1 lbs

- Tough, break-resistant acrylic

Item	Model	Size	Net
401920	5056	8 oz., Red wine	\$5.99
401919	5054	8 oz., White wine	5.99
401918	5057	10 oz., Martini	5.99
402798	DP 5504	10 oz., White wine	5.99
402799	DP 5507	14 oz., Wine goblet	6.99
402800	DP 5502	14 oz., Rocks tumbler	6.49
402801	DP 5503	18 oz., Tumbler	6.99
402802	DP 5501	6 oz., Champagne flute	5.99
402803	DP 5506	18 oz., Beer stein	8.99
402804	DP 5509	54 oz., Pitcher	21.99
402805	DP 5505	12 oz., Margarita	6.49

### ACRYLIC NESTING WINE GLASSES - SET OF 4

- These glasses nest together to maximize your cabinet space

**Specify:** Clear, Green or Blue

Item	Size	Ship	Net
402565	8 oz.	2 lbs	\$16.99

### NON-SKID POLYCARBONATE SETS- SET OF 4

- Double insulated • Non-skid ring • Lifetime warranty

**Specify:** Sailboat (16 oz. only), Captains, Game Fish, Lighthouse, Blue Crab or Jolly Roger

Item	Size	Ship	Net
400886	12 oz.	2 lbs	\$25.99
400885	16 oz.	3 lbs	29.99

### Wine Glasses Set with non-skid ring

Item	Model	Size	Ship	Net
400304	5000	12 oz.	1 lbs	\$25.99



## Table Accessories

### GALLEYWARE OCEAN WINCH SALT AND PEPPER MILLS

Patterned after Lewmar winches, our mills will be the talk of the table! Made of anodized aluminum and marine grade stainless steel and featuring a state of the art ceramic grinding mechanism that allows for perfectly ground salt and pepper. Whether offshore, at anchor, or in your home, our mills are guaranteed classics for your table

Item	Model	Description	Ship	Net
402806	KN1004	Salt & Pepper mills	2 lbs	\$109.99



### OCEAN REEL SALT AND PEPPER MILLS

- Hard anodized aluminum
- Sold as a pair
- Both include state-of-the-art ceramic grinding mechanisms

Item	Model	Description	Ship	Net
402239	KN1001	Salt & Pepper mills	2 lbs	\$113.99
402240	KN1002	Teak base	1 lbs	14.99



### GALLEYWARE SEA REEL SALT AND PEPPER MILLS

Item	Model	Description	Ship	Net
402807	KN1005	Sale & Pepper mills	2 lbs	\$64.99



### ANCHOR FLATWARE SETS

Five piece setting includes dinner fork, salad fork, tablespoon, teaspoon and knife. Has plastic handle with anchor design. Includes tray. Dishwasher safe. 18/10 stainless steel. **Specify:** Blue or White handle. **Specify:** Service for four, six or eight.

Item	Setting	Size	Ship	Net
401151	4		2 lbs	\$42.99
	6		3 lbs	63.99
	8		4 lbs	85.99



### MELAMINE APPETIZER TRAY

- (3) Separated compartments
- 14-3/4" x 6" x 2"

**Specify:** Anchor, Blue Crab or Sea Turtle

Item	Ship	Net
402564	1 lbs	\$9.99



### LEXAN SALT-N-PEPPER COMBO

- Small, combined salt and pepper container
- Allows you to minimize the items on your galley table
- Both ends have airtight caps to keep humidity out

Item	Ship	Net
401507	1 lbs	\$6.99



## Teak Products

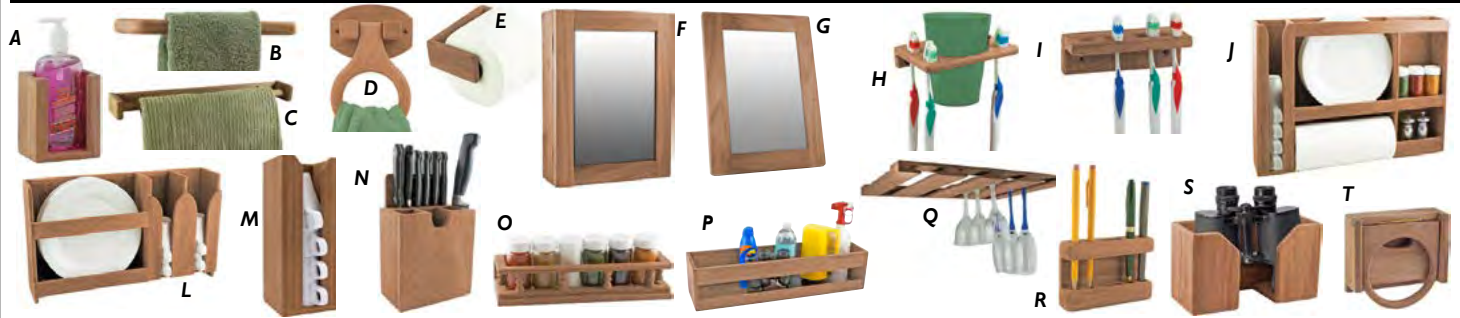

Item	Model	Description	Dimensions (L x W x H)	Ship	Net	Item	Model	Description	Dimensions (L x H x W)	Ship	Net		
A	401082	62316	Liquid Soap Holder	3-3/4" x 2-3/4" x 4-3/8"	1 lbs	\$19.99	J	650276	62402	Dish, Spice, Cup & Towel	22-3/8" x 16" x 4"	6 lbs	\$121.99
B	401194	62330	Towel Bar	14" x 1" x 2-1/2"	1 lbs	14.99	K	401197	62406	Dish and Cup	19-3/4" x 11-1/2" x 4-1/4"	5 lbs	89.99
	401195	62332	Towel Bar (long)	23" x 1" x 2-1/2"	1 lbs	22.99	M	401084	62408	Modular Cup Rack	4-1/4" x 10-3/8" x 4-1/4"	3 lbs	30.99
C	650746	62334	Towel Rack	16" x 3" x 1-7/8"	1 lbs	18.99	N	401085	62414	Cutlery Rack	5-3/4" x 8-5/8" x 3-3/8"	3 lbs	48.99
D	401196	62338	Towel Ring	6" x 9-1/2" x 2"	2 lbs	37.99	O	401199	62436	Spice Rack	14" x 2-7/8" x 4"	2 lbs	36.99
E	401083	62322	Toilet Paper Holder	1-7/8" x 5-1/2" x 3-3/4"	1 lbs	15.99	P	401176	62554	Utility Shelf	21" x 5" x 6"	3 lbs	65.99
F	650747	62354	Medicine Chest	15" x 11" x 4-1/2"	8 lbs	114.99	Q	401198	62425	Overhead Wine Glass	16-5/8" x 11-3/4" x 7/8"	2 lbs	52.99
G	650273	62544	Mirror (rectangle)	15" x 11" x 3/4"	3 lbs	51.99	R	650749	62536	Pen/Pencil Holder	4-3/4" x 3-1/4" x 1-1/8"	1 lbs	12.99
H	401097	62312	Glass/Toothbrush Holder	1-1/16" x 4-3/4" x 3-2/3"	1 lbs	13.99	S	401175	62702	Binocular Rack	8-5/8" x 4-7/8" x 3-1/2"	2 lbs	23.99
I	401096	62310	Toothbrush Holder	5-3/4" x 1-7/8" (L x W)	1 lbs	13.99	T	401094	62602	Folding Drink Holder (holds 1 insulated can)		1 lbs	32.99



Item	Model	Description	Dimensions (L x H x W)	Ship	Net	Item	Model	Description	Dimensions (L x H x W)	Ship	Net		
A	401093	62616	Drink Rack holds 2 cans or 1 Pair of Binoculars	13" x 3-3/4" x 4-5/8"	2 lbs	\$46.99	G	401192	62520	CD/DVD Rack	8-5/8" x 5-5/8" x 5-1/4"	1 lbs	\$36.99
B	401179	62446	Spice Rack, Towel Holder	13-1/16" x 10" x 3-3/4"	3 lbs	67.99	H	401080	62632	4 Drink/Binocular Rack	14-1/4" x 4" x 3-1/2"	2 lbs	38.99
C	401098	62420	Small Trivet ea.	6" Square	2 lbs	17.99	I	401193	62634	4 Insul. Drink/Binoc. Rack	16-3/4" x 3-1/2" x 4-1/2"	2 lbs	53.99
C	401190	62421	Large Trivet ea.	8" Square	1 lbs	18.99	J	401090	62610	2-Drink Holder	7-1/2" x 3-1/2" x 3-5/8"	1 lbs	27.99
D	401200	62506	Magazine Rack	14-3/4" x 12" x 4-1/4"	1 lbs	47.99	K	401071	60831	Rail Molding	5" x 1-5/8" x 13/16"	2 lbs	36.99
E	401091	62508	Magazine Rack	18-5/16" x 9-1/2" x 4-1/8"	4 lbs	62.99	L	754559	60832	Inside Corner (Radius: inside 1-3/4", outside 2-1/4")		1 lbs	17.99
F	401201	62512	Book Rack	15" x 7-1/4" x 7-1/4"	3 lbs	66.99	M	401072	60837	Outside Corner (Radius: inside 2", outside 2-1/2")		1 lbs	14.99
						N	754427	60836	Inside Corner (Radius: inside 1-3/4", outside 2-1/4")		1 lbs	14.99	



### SEATEAK BULKHEAD MOLDING

The SeaTeak® collection from Waterbrands® uses only responsibly harvested and legal teak in their products. Careful selection of the finest raw timber ensures the final product is free from knots, pinholes, stains and sapwood.

- Type: Straight length edge molding
- Hand-sanded and hand-finished 100% teak
- Only waterproof adhesive is used



### BULKHEAD MOLDING for 3/4" wide, 1/4" deep track.

Item	Model	Description	Ship	Net
401073	60825	5' L x 5/8" H x 1-3/16" W	1 lbs	\$20.99
401074	60827	Outside corner (Radius: inside 2-1/4", outside 2-3/4")	1 lbs	12.99
401075	60826	Inside corner (Radius: inside 2", outside 2-1/2")	1 lbs	13.99



### TEAK PLUGS - 20 per pack, 1/2" L

Item	Model	Dia.	Ship	Net/20
751219	60150	1/4"	1 lbs	\$4.49
754579	60151	3/8"	1 lbs	4.99
401069	60152	1/2"	1 lbs	4.99
401070	60153	5/8"	1 lbs	6.99



### SEATEAK SOLID TEAK STRING MAT

- Resists mold for a cleaner environment
- Rolls up for easy storage
- Non-slip, oiled finish
- Dimensions: 19-3/4" L x 19-3/4" W x 5/8" H

Item	Model	Ship	Net
650730	60020	7 lbs	\$65.99



### TEAK HANDRAILS & STEP PADS

Item	Model	Description	Dimensions (L x H x W)	Ship	Net
650748	60101	Handrail one loop	13" x 2-3/8" x 1"	1 lbs	\$13.99
650537	60102	Handrail two loop	23" x 2-3/8" x 1"	1 lbs	18.99
401086	60104	Handrail three loop	33" x 2-3/8" x 1"	2 lbs	26.99
401087	60106	Handrail four loop	43" x 2-3/8" x 1"	2 lbs	32.99
401088	60108	Handrail five loop	53" x 2-3/8" x 1"	2 lbs	47.99
401089	60110	Handrail six loop	63" x 2-3/8" x 1"	2 lbs	55.99
401064	60112	Handrail seven loop	73" x 2-3/8" x 1"	2 lbs	67.99
650533	60502	Step pad	15" x 6" x 1/2"	1 lbs	21.99



### A Louver Inserts



### B Door and Frame



### TEAK LOUVERS & DOORS

Item	Model	Description	Dimensions (L x H x W)	Ship	Net	
A	401202	60710	Louver insert	9-1/8" x 16" x 3/4"	2 lbs	\$38.99
A	401092	60712	Louver insert	9-1/8" x 7-1/2" x 3/4"	1 lbs	25.99
A	401203	60714	Louver insert	11-3/16" x 6-3/8" x 3/4"	1 lbs	25.99
B	401205	60720	Door and frame right opening	12" L x 12" H	3 lbs	62.99
B	401204	60721	Door and frame left opening	12" L x 12" H	3 lbs	62.99
B	401061	60722	Door and frame right opening	15" L x 15" H	4 lbs	76.99
B	401067	60723	Door and frame left opening	15" L x 15" H	4 lbs	76.99
B	650315	60724	Door and frame right opening	15" L x 20" H	5 lbs	89.99
B	401066	60725	Door and frame left opening	15" L x 20" H	5 lbs	89.99



## Organizers

### SCHAEFER "HANDI-HANGERS" LINE HOLDER

- Organize line, fenders, life rings, electrical cords, hoses, etc.
- Quick to release, neater than sheet bags and more versatile for line handling/stowing
- Works with 7/8" or 1" rails (Vinyl liner protects rails)
- Safe working load is 20 lbs

Item	Model	Type	Qty	Ship	Net
756279	HH	Rail/Flat	2	1 lbs	\$16.99

### BARTON NYLON LINE TAMERS (PAIR)

- Holds and hangs rope coils of up to 20 cm diameter

Please specify color: Gray or White

Item	Qty	Ship	Net
606948	2	1 lbs	\$15.99

### BLUE PERFORMANCE BAGS

Designed to be mounted on the bulkhead. These bags can store all your sheets and other loose items that would otherwise get in the way. Made from a hard-wearing, water-repellent gray ripstop material. The bags mount to the bulkhead using mounting hooks and screws (included) so that they can easily be removed when your boat is not in use.

#### LARGE CABIN BAG

- 17.7" L x 22.8" H x 2.8" D

Item	Model	Ship	Net
608905	BP3585	3 lbs	\$67.99

#### SMALL CABIN BAG

- 13.4" L x 18.5" H x 2.8" D

Item	Model	Ship	Net
608904	BP3580	2 lbs	\$59.99

#### LARGE COCKPIT BAG

- 18.5" L x 11.8" H x 2.0" D

Item	Model	Ship	Net
608900	BP3400	3 lbs	\$64.99

#### SMALL COCKPIT BAG

- 11.8" L x 7.9" H x 2.0" D

Item	Model	Ship	Net
608899	BP3410	1 lbs	\$48.99

#### LARGE COCKPIT COMBI-BAG

- 18.5" L x 11.8" H x 2.8" D

Item	Model	Ship	Net
608901	BP3405	4 lbs	\$68.99

### GREEN MOUNTAIN RIGGER'S BAG

- Two levels of pockets surround the central compartment
- 24 oz. canvas with rolled seams and a reinforced bottom
- Self-standing
- Machine washable
- Color: Natural with leather trim

Item	Model	Size	Ship	Net
754129	15002	14" x 7" x 9"	2 lbs	\$29.99

### GREEN MOUNTAIN RIGGER/TOOL BAG

- Leather trim with shoulder strap and Velcro® closure

Item	Model	Size	Ship	Net
754593	15003	Natural 14" x 7" x 9"	3 lbs	\$34.99

### GREEN MOUNTAIN TRAVEL TOTE

- Full zipper tops with wallet pocket and key clip inside
- Very sturdy tote with reinforced handles
- Natural with Navy straps

Item	Model	Size	Ship	Net
754099	15330	16" x 7" x 11"	2 lbs	\$23.99
754097	15350	21" x 9" x 15"	2 lbs	28.99

### BECKSON STOW-AWAY DECK PLATE WITH STORAGE BAG

- 12" nylon bag fits neatly into deck plate; offers dry storage
- Bag is removable for access below-decks and to carry items
- Perfect for watertight storage of watches, wallets, etc.
- Color: White deckplate, Red storage bag

Item	Model	Size	Ship	Net
612136	DP40BW	4"	1 lbs	\$36.99
612137	DP60BW	6"	1 lbs	42.99

### BECKSON DITTY BAG RETROFIT KIT

- Includes a bag retaining ring to convert a Beckson screw-out deck plate to accept a drop-in drawstring ditty bag

Item	Model	Size	Ship	Net
615152	D4SKBAG	4" x 12"	1 lbs	\$21.99
615154	D6SKBAG	6" x 12"	1 lbs	22.99
615153	D8SKBAG	8" x 12"	1 lbs	23.99

### WHITECAP GEAR HAMMOCK

- Made of sturdy White nylon
- 62" long
- Great for storing laundry, clothes or supplies

Item	Model	Ship	Net
951291	S-9023	1 lbs	\$5.99

### BLUE PERFORMANCE SAILBOAT HAMMOCK

- 82.7" L x 39.4" W
- Light Gray/Blue Rip-Stop/Mesh

Item	Model	Ship	Net
600547	BP190	5 lbs	\$219.99

### STAINLESS STEEL HAMMOCK LASHING HOOKS- All ship 1 lbs

Item	Model	L x W x D	Net
752288	S-182	1/2" x 1-1/4" x 3/4"	\$3.99/Pr.

### SEA-DOG GEAR HAMMOCK HOOKS (PAIR)

- Stainless steel hammock hooks
- Installs with two #6 FH fasteners (not included).

Item	Model	L x W x D	Ship	Net
951329	671460-1	15/16" x 1-1/4" x 1/2"	1 lbs	\$2.99

### WHITE WATER MARINE BOAT HOOK BRACKETS

- 304 stainless steel stamped
- Dimensions: 1" W x 4" H
- Fastener: #12 FH

Item	Model	Ship	Net/Pair
651044	7715S	1 lbs	\$10.99

### SEA-DOG FOLDING POLE STORAGE BRACKETS

- Injection molded nylon / Stainless steel
- Each bracket mounts with (4) #12 FH fasteners (not included)

Item	Model	Ship	Net/Pair
756044	491140-1	1 lbs	\$18.99

### BECKSON PLASTIC CLIPPER™ HOLDING CLIPS - All ship 1 lbs

- Heavy duty Black plastic clips are non-magnetic and non-corrosive
- Ideal for storing boat hooks, mops, flashlights, tools, etc.
- All models are 1/8" holes on 3/4" centers

Item 756680 • Please Specify Size

Model	Size	Fastener	Net/Pr.
CLP-3/4	3/4"	#6 flat head	\$4.99
CLP-1	1"	#6 flat head	5.99
CLP-1-1/4	1-1/4"	#6 flat head	5.99
CLP-1-1/2	1-1/2"	#6 flat head	5.99
CLP-1-3/4	1-3/4"	#6 flat head	6.99

### METAL SPRING CLAMPS

- 1" Stainless steel clamps
- Extension: 1" - 1-3/4"
- Used to hold fishing rods, oars, brooms, etc.

Item	Model	Ship	Net
752371	S-149	1 lbs	\$7.99

### UNIVERSAL CLIPS

- 7/8" wide, 4-1/2" long
- Poly clip with stainless steel spring
- Fits over 7/8" rail

Item	Model	Qty	Ship	Net
755276	SCP 36381	2	1 lbs	\$8.99

### BERNARD SEA SNAP® CLOTHES PIN

- Made entirely of polycarbonate, including the spring
- Wet towel tested
- Designed to fit railings from 3/4" to 1-1/4"

Item	Model	Ship	Net
400975	SSI TEA	1 lbs	\$5.99

### FLEXIBLE UTILITY GROMMET

- Applications: rod holders, wire/cable/hose pass thru
- Mount: flat surface, horizontal or vertical
- Color: Black

Item	Model	Outside Dia.	Center Hole	Ship	Net
402589	UG2SP	2-3/4"	1/2"	1 lbs	\$9.99
	UG1DP	3-3/8"	1"	1 lbs	9.99

### SEA-DOG COAT HOOKS

- Sand cast brass construction
- Installs with #6 FH fasteners (Not included)
- All ship 1 lbs

Item	Model	Size	Finish	Qty	Net
400990	671500-1	Single, small	Chrome	2	\$9.49
400991	671505-1	Single, small	Brass	2	8.99
400992	671501-1	Single, large	Chrome	2	9.49
400993	671506-1	Single, large	Brass	2	8.49
400994	671510-1	Double	Chrome	2	11.99
400995	671515-1	Double	Brass	2	10.99
400996	671520-1	Triple	Chrome	1	9.49
400997	671525-1	Triple	Brass	1	8.99

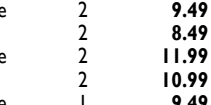
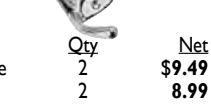
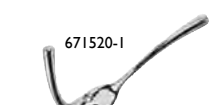

**ANNIN EMBROIDERED U.S. FLAG**

High quality Nyl-glo fabric with large brass grommets.

Item	Model	Size	Ship	Net
650342	002600	12" x 18"	1 lbs	\$18.99
650343	002610	16" x 24"	1 lbs	19.99
650344	002620	20" x 30"	1 lbs	21.99
650345	002420	24" x 36"	1 lbs	23.99
650346	002440	30" x 48"	1 lbs	29.99
650347	002460	36" x 60"	1 lbs	32.99
650348	002220	48" x 72"	1 lbs	48.99
650349	002270	60" x 96"	2 lbs	76.99



**ANNIN YACHT ENSIGN**

Embroidered nylon. Sewn field, stripes, stars and anchor. Sizes up to 24" x 36" feature embroidered stars. Larger sizes have appliqued stars. Canvas heading and brass grommets. All ship 1 lbs.

Item	Model	Size	Boat Size	Net
650321	251100WE	12" x 18"	18'	\$18.99
650322	251150WE	16" x 24"	24'	20.99
650323	251200WE	20" x 30"	30'	25.99
650324	251250WE	24" x 36"	36'	28.99
650325	251300WE	30" x 48"	48'	69.99
650326	251350WE	36" x 60"	60'	72.99

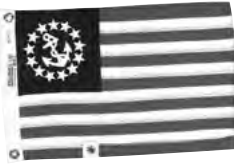

**ANNIN U.S. POWER SQUADRON ENSIGN**

Embroidered Nyl-glo (colorfast nylon) ensigns of U.S. Power Squadrons. Sewn stars and anchor. Double-stitched stripes. Canvas heading and brass grommets.

Item	Model	Size	Ship	Net
650316	252100WE	12" x 18"	1 lbs	\$15.99
650317	252200WE	16" x 24"	1 lbs	20.99



**TAYLOR MADE DECORATIVE INTERNATIONAL SIGNAL FLAG SET**

40 Flags. Flag Size: 12" x 18". Nylon. Includes storage bag. Item 650088 Model 93245 Ship 3 lbs Net \$58.99

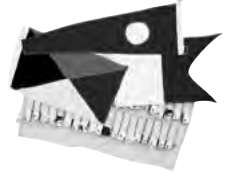

**ANNIN INTERNATIONAL CODE OF SIGNALS**

- Set consists of 26 alphabet flags, 11 pennants and 3 substitute flags
- Finished with nylon rope, distance lines and ash toggles
- Each 40-piece set includes a handy nylon storage bag
- Flag size: 12" x 15"; Pennant size: 8" x 24"
- Substitute size, 2/3' x 1-1/3'

Item 650913 Model 256000 Ship 7 lbs Net \$359.99

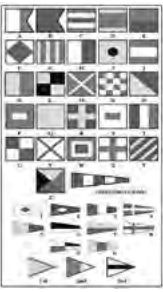

**MISCELLANEOUS FLAGS AND PENNANTS All ship 1 lbs.**

Item	Description	Size	Net
A. 650338	Cocktail - nylon	12" x 18"	\$9.99
B. 650340	Red: Protest	12" x 18"	12.99
C. 650015	Yellow: Quarantine	12" x 18"	13.99
D. 550748	Distress - Vinyl; storage bag; USCG approved	3' x 3'	8.99
E. 800654	Pirate Jolly Roger - nylon	12" x 18"	10.99
F. 800577	Diver Down - nylon	12" x 18"	12.99
800578	Diver Down - nylon	20" x 30"	19.99



**TEAK FLAG POLES - Hardware not included.**

Item	Length	Base	Ship	Net
401062	18"	3/4"	1 lbs	\$15.99
401063	24"	1"	1 lbs	18.99
650546	30"	1"	1 lbs	22.99

**TAYLOR MADE STAINLESS STEEL FLAG POLES**

The staff, finial base and flag clips are all made from highly polished 304 stainless steel. The flag clips hold your flag taut so that it's never tangled. Base included. 1" pole diameter.

Item	Model	Length	Flag Size	Ship	Net
651063	902	18"	12" x 18"	2 lbs	\$71.99
	903	24"	16" x 24"	3 lbs	86.99
	904	30"	24" x 36"	3 lbs	91.99
	905	36"	30" x 48"	3 lbs	95.99
	907	48"	36" x 60"	5 lbs	117.99



**TAYLOR MADE SKIPPER FLAG CLIPS**

- Includes (4) skipper clips and (4) self-tapping screw eyes
- Extended length of clips reaches grommets 3/4" from fabric edges

Item 650528 Model 57933 Ship 1 lbs Net \$10.99



PLEASE SEE PAGE 190 FOR SNAP HOOKS



Canada



Bermuda

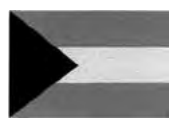

Bahamas (National)



Barbados



St. Lucia



Trinidad & Tobago

**COURTESY FLAGS**

A must when entering foreign ports. Made of heavyweight nylon fabric and finished with heavy duty duck headings and grommets. All ship 1 lbs.

Item	Model	Style	Size	Net
650364	281200WE	Canada	12" x 18"	\$12.99
650365	281450WE	Bermuda	12" x 18"	16.99
650366	281405	Bahamas (National)	12" x 18"	16.99
650367	281410WE	Bahamas (Courtesy)	12" x 18"	12.99
650368	281475WE	Mexico	12" x 18"	13.99
650370	193993	Italy	12" x 18"	12.99
650371	192680	France	12" x 18"	12.99
650372	190530WE	Barbados	12" x 18"	19.99
650373	221275	British Virgin Islands	12" x 18"	21.99
650375	979632	Martinique	12" x 18"	13.99
650376	197221	St. Lucia	12" x 18"	19.99
650377	979630	St. Maarten	12" x 18"	19.99
650378	198509	Trinidad & Tobago	12" x 18"	22.99
650379	281500	U.S. Virgin Islands	12" x 18"	13.99
650912	193425	Honduras	12" x 18"	19.99
650911	192990	Grenada	12" x 18"	21.99
650910	190580	Belize	12" x 18"	22.99
650834	978336	Costa Rica	12" x 18"	13.99
650718	900659	Spain	12" x 18"	13.99
650035	900660	Guatemala	12" x 18"	13.99



**PERKO FLAG POLE SOCKETS All ship 1 lbs.**

Item	Model	I.D. Size	Description	Angle	Net
650352	0220DP1CHR	3/4"	Bow upright	0°	\$48.99
650359	0219DP1CHR	3/4"	Stern flush	26°	35.99
650355	0218DP2CHR	1"	Bow flush	0°	40.99
650357	0219DP2CHR	1"	Stern flush	26°	47.99
650353	0221DP2CHR	1"	Stern upright	13°	58.99
650356	0218DP3CHR	1-1/4"	Bow flush	0°	47.99
650358	0219DP3CHR	1-1/4"	Stern flush	26°	56.99
650354	0221DP3CHR	1-1/4"	Stern upright	13°	72.99

**TAYLOR MADE STAINLESS STEEL RAIL MOUNT FLAG POLE SOCKETS**

Designed to fit Taylor stainless steel flagpoles models 902 through 907, perpendicular to the rail. Made for 1" diameter flag poles.

Item	Model	Fits	Ship	Net
650086	973	7/8" - 1" rail	2 lbs	\$37.99
650087	974	1-1/8" - 1-1/4" rail	2 lbs	43.99

**TAYLOR MADE FLAG POLE AND SOCKET WITH FLAG**

Developed with the pontoon boater in mind. Black nylon mount attaches easily to the top of your pontoon railing or any flat surface and features a 10 degree presentation angle. Comes with sewn U.S. flag.

Item	Model	Flag	Pole	Ship	Net
650067	921	12" x 18"	24"	2 lbs	\$38.99
650068	922	16" x 24"	30"	3 lbs	46.99

**TAYLOR MADE PULPIT STAFF**

Complete with split rings. 15" long.

Item	Model	Fits Round Rails	Ship	Net
650361	971	7/8" to 1-1/4"	1 lbs	\$18.99

**FLAG SPREADER HALYARD KIT**

This kit provides everything you need to add a flag halyard to your boat. Includes:

- 40' of 3/16" diameter polyester line
- Block with bail
- And the famous Johnson shroud cleat for tying off the halyard

Item	Model	Description	Ship	Net
650351	40-530	Spreader kit	1 lbs	\$56.99





Limited Lifetime  
Warranty! on  
finish and movement\*

\*Endurance and  
Endurance II Collections

## Time & Weather Instruments

# Weems & Plath®

- Maintenance free, ultra-hard protective coating
- Guaranteed not to tarnish or scratch
- Beveled glass crystal
- Mounting methods for boat or shore
- Weather resistant



Please visit  
**defender.com**  
for clock bases,  
additional products  
and more detailed  
specifications.

### Endurance II Collection

#### TRADITIONAL PORTHOLE STYLE WITH FRONT OPENING BEZEL

#### 105 Series

Dial: 3-1/5" • Base: 4-3/4" • Depth: 2-1/8" • Weight .80 lbs All ship 2 lbs

Thermometer



Item **800636**  
Model **131200**  
M.A.P. \$139.99

Comfortmeter



Item **800635**  
Model **130900**  
M.A.P. \$144.99

Chrome Clock



Item **800630**  
Model **120500**  
M.A.P. \$144.99

Chrome Open Dial Barometer



Item **800631**  
Model **120733**  
M.A.P. \$154.99

Brass Clock



Item **800632**  
Model **130500**  
M.A.P. \$144.99

Brass Open Dial Barometer



Item **800634**  
Model **130733**  
M.A.P. \$154.99

#### 115 Series

Dial: 4" • Base: 6" • Depth: 3-1/8" • Weight 1.25 lbs All ship 2 lbs

Chrome Clock



Item **805453**  
Model **560500**  
M.A.P. \$179.99

Brass Clock



Item **800638**  
Model **510500**  
M.A.P. \$179.99

Tide & Time



Item **800637**  
Model **510300**  
M.A.P. \$199.99

Open Dial Barometer



Item **800640**  
Model **510733**  
M.A.P. \$189.99

Comfortmeter



Item **800641**  
Model **510900**  
M.A.P. \$179.99

Barometer/Thermometer



Item **800642**  
Model **511000**  
M.A.P. \$189.99

#### 135 Series

Dial: 5" • Base 7" • Depth: 2-1/2" • Weight 2 lbs All ship 3 lbs

Brass Clock



Item **800661**  
Model **950500**  
M.A.P. \$209.99

Open Dial Barometer



Item **800666**  
Model **950733**  
M.A.P. \$219.99

Comfortmeter



Item **800667**  
Model **950900**  
M.A.P. \$209.99

Barometer/  
Thermometer



Item **800668**  
Model **951000**  
M.A.P. \$219.99

Time and Tide  
Clock



Item **800660**  
Model **950300**  
M.A.P. \$239.99

24 Hour Radio Room Clock



Item **800663**  
Model **950509**  
M.A.P. \$199.99

### Endurance Collection

#### CLASSIC STYLE

#### 085 Series

Dial: 3-3/8" • Base 4-1/8" • Depth: 1-1/2" • Wt: .65 lbs All ship 1 lbs

Brass Finish

Clock



Item **800037**  
Model **230500**  
M.A.P. \$129.99

Barometer



Item **800038**  
Model **230700**  
M.A.P. \$134.99

Comfortmeter



Item **800039**  
Model **230900**  
M.A.P. \$129.99

#### 125 Series

Dial: 4-7/8" • Base: 6" • Depth: 1-5/8" • Weight 1.3 lbs All ship 2 lbs

Brass Finish

Item	Model	Description	M.A.P.
805383	530500	Clock	\$144.99
805384	530700	Barometer	154.99
805385	530900	Comfortmeter	144.99
800046	530300	Tide and Time	159.99

Chrome Finish

Item	Model	Description	M.A.P.
800059	540500	Clock	\$144.99
800060	540700	Barometer	154.99
800061	540900	Comfortmeter	139.99
800062	540300	Tide and Time	159.99



Clock Barometer Comfortmeter Tide and Time

### Atlantis™ Collection

Dial: 4" • Base: 5-1/2" • Depth: 2-7/8" All ship 5 lbs

See a complete list of the Atlantis  
Collection at [defender.com](http://defender.com)

8-Day Wind Ship's  
Bell Brass Clock



Item **800689**  
Model **200200**  
M.A.P. \$969.99

\*Lifetime Warranty

⊕ Item **800684**  
Model **200100**  
M.A.P. \$569.99

Ship's Bell  
Brass Clock



⊕ Item **800688**  
Model **220100**  
M.A.P. \$579.99

Ship's Bell  
Chrome Plated  
Clock



\*2 Year Warranty

Item **800685**  
Model **200700**  
M.A.P. \$354.99

Barometer  
Brass



Item **800687**  
Model **220700**  
M.A.P. \$369.99

Barometer  
Chrome  
Plated



\*Lifetime Warranty

Item **800686**  
Model **200300**  
M.A.P. \$399.99

Time and Tide  
Brass Clock



Item **800690**  
Model **220300**  
M.A.P. \$409.99

Time and Tide  
Chrome  
Plated



\*Lifetime Warranty

### Admiral Collection

Dial: 6" • Base: 7-1/2" • Depth: 2-5/8"

Item	Model	Description	Ship	M.A.P.
804067	290500	Quartz Clock	4 lbs	\$288.99

\*Lifetime warranty on movement

Item	Model	Description	Ship	M.A.P.
804068	290700	Barometer for altitudes to 1500' above sea level	5 lbs	\$288.99



Clock



Barometer

**Webasto Marine Air Conditioners with Reverse Cycle Heat**

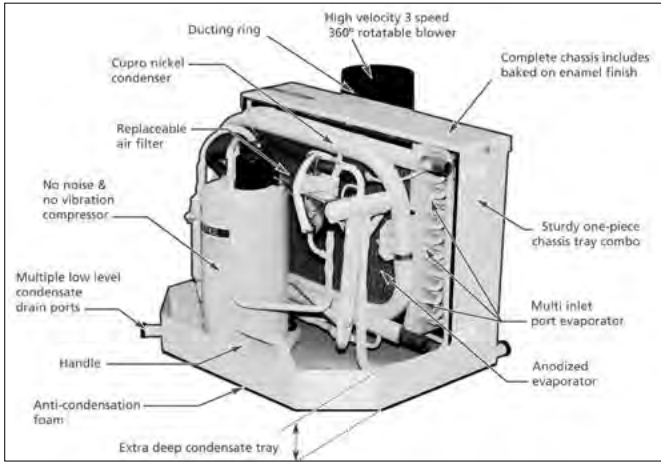

**FCF SERIES - FEEL COOL FAST® SELF-CONTAINED AIR CONDITIONERS**

A compact air conditioning system that provides comfort with whisper quiet operation.

- Balanced system for vibration and noise elimination
- Compact design that allows for zero-clearance installations
- Unibody weld provides superior strength
- High output in a single compact unit
- Includes control panel and remote panel • 360° rotatable blower

**VISIT DEFENDER.COM FOR WEBASTO ACCESSORIES.**

**FCF PLATINUM SERIES - SELF-CONTAINED AIR CONDITIONERS**

- 12K and 16K units feature a long, slim footprint for an easy retrofit of existing units
- Digital display, controller and cable comes standard
- 2-year warranty with unmatched product reliability
- Marine-grade stainless steel frame for durability and longevity
- Proprietary compressor - well balanced and quieter than ever
- Low cost replacement parts
- 360° rotatable blower

Item	Series	BTU/Hr	Voltage (specify)	Frequency	Seawater Inlet/Outlet	Ducting Collar Diameter	Dimensions	Warranty	Ship	Net
Ⓞ 901694	FCF Platinum	6000	115 or 230V	60 or 50/60 Hz	3/4"	4"	11.2" L x 16" D x 11.6" H	2 Years	75 lbs	\$1374.99
Ⓞ 901695	FCF Platinum	10000	115 or 230V	60 or 50/60 Hz	3/4"	4"	15" L x 16" D x 12.2" H	2 Years	73 lbs	1534.99
Ⓞ 901544	FCF Classic	12000	115 or 230V	60 or 50/60 Hz	3/4"	5"	15" L x 17.2" D x 13" H	2 Years	81 lbs	1464.99
Ⓞ 901691	FCF Platinum	12000	115 or 230V	60 or 50/60 Hz	3/4"	5"	<b>** 21.6" L x 12.6" D x 13" H</b>	2 Years	91 lbs	1699.99
Ⓞ 901545	FCF Classic	16000	115 or 230V	60 or 50/60 Hz	3/4"	5"	17.7" L x 17.9" D x 13" H	2 Years	97 lbs	1564.99
Ⓞ 901692	FCF Platinum	16000	115 or 230V	60 or 50/60 Hz	3/4"	5"	<b>** 24.4" L x 13.5" D x 13" H</b>	2 Years	104 lbs	1824.99
ⓂⓄ 901696	FCF Platinum	20000	230V	50-60 Hz	3/4"	5" (2)	23.4" L x 20.8" D x 15.2" H	2 Years	145 lbs	2624.99
ⓂⓄ 901697	FCF Platinum	25000	230V	50-60 Hz	3/4"	5" (2)	23.4" L x 20.8" D x 15.2" H	2 Years	145 lbs	2774.99

**\*\* NEW SLIMMER FOOTPRINT**

**PLEASE VISIT DEFENDER.COM FOR INSTALLATION GUIDES AND ADDITIONAL SPECIFICATIONS.**

**INSTALLATION ACCESSORIES**

**KOOLAIR SEAWATER PUMPS**

- Specify 115 or 230 VDC

Item	Type	Application	Net
901778	Submersible	5-10K BTU	\$284.99
901779	Non-submersible	12-16K BTU	324.99

**COMPLETE SEAWATER KITS**

- Feature KoolAir pumps

Item	Application	VDC	Net
901799	5-10K BTU	115 or 230	\$909.99
901800	12-16K BTU	115 or 230	1089.99

**AIR DUCT KITS**

Item	Application	VDC	Net
900755	5-10K BTU	115 or 230	\$324.99
900756	12-16K BTU	115 or 230	454.99

**DOMETIC Air Conditioning (formerly Marine Air)**

Enjoy ideal temperatures on your boat year-round with EnviroComfort (ECD) self-contained air conditioning kits.

- 3 sizes ranging from 6,000 to 16,000 BTU/hr cooling and reverse-cycle heating
- Rotatable blower
- Digital display/control included
- Space-saving design
- Retrofit Kit - Replace older system of similar capacity or use for new installation
- Optional installation kit - Includes all air and plumbing components for new installation



**DOMETIC ENVIROCOMFORT RETROFIT UNITS - COOL AND HEAT - DIGITAL DISPLAY**

Item	Model #	VAC	BTU/HR	Refrigerant	Hz / Ph	Full Load Amps Cool/Heat	Locked Rotor Amps	Size H" x W" x D"	Ship	Net
901529	207500306	115	6000	R-410A	60 / 1	4.6 / 5.9	36	11.25 x 16 x 9	52 lbs	\$1724.99
901530	207500310	115	10000	R-410A	60 / 1	7 / 9.1	42	13.25 x 20 x 9.63	61 lbs	1924.99
901676	207500316	115 / 230	16000	R-410A	60 / 1	10.5 / 13.7	62	13.5 x 20 x 11.25	71 lbs	2054.99 / 2084.99

**INSTALLATION KITS**

Item	Model #	VAC	Designed for	Description	Ship	Net
901532	218000106	115	5K & 6K BTU units	Includes all air distribution and plumbing components needed to air condition a single space and is added to the Retrofit Kit for a complete system installation.	30 lbs	\$899.99
901533	218000110	115	9K & 10K BTU units		30 lbs	944.99
901534	218000116	115	15K & 16K BTU units		30 lbs	999.99

**DUAL DUCT KIT**

Item	Model #	Designed for	Description	Ship	Net
900829	226600092	9K, 10K, 15K & 16K BTU units	Includes a "Y" connector, 12.5 ft. (3.8 m) of flexible duct and supply air grille for air conditioning a second space.	7 lbs	\$154.99

Seawater/Ducting Installation kits and complete DIY systems available at [defender.com](http://defender.com)



## Refrigeration and A/C Pumps

### MARCH MARINE - MAGNETIC DRIVE SEAWATER PUMPS - LIQUID COOLED MODELS

- Ignition protected • Should be mounted below the waterline **Includes:** • Marine grade base • 6' power cord
- Excellent choice for providing seawater circulation for marine air conditioning systems

**LC (Liquid Cooled) pumps can be run in open air or submerged**

Item	Model	GPH	Inlet	Outlet	Specify	Draw @ 115 VAC	Max PSI	Ship	Starting At
502654	LC-2CP-MD	300	3/8" & 3/4"	1/4"	115 or 230 VDC	1.1 A	25	6 lbs	\$334.99
502653	LC-3CP-MD	510	3/4"	1/2"	115 or 230 VDC	2.36 A	25	8 lbs	224.99
502648	LC-5C-MD	870	1"	1/2"	115 or 230 VDC	1.6 A	50	18 lbs	656.99



1 Year Warranty!

### MARCH MARINE - MAGNETIC DRIVE SEAWATER PUMPS - AIR COOLED MODEL

- Ignition protected • Air cooled, open drip motors **Includes:** • Mounting base • 6' power cord
- Excellent choice for providing seawater circulation for marine air conditioning systems

**Air cooled pumps must be mounted in a dry environment**

Item	Model	GPH	Inlet	Outlet	Specify	Draw @ 115 VAC	Max PSI	Ship	Starting At
502649	AC-5C-MD	1020	1"	1/2"	115 or 230 VDC	2.1 A	50	9 lbs	\$303.99



1 Year Warranty!

### KOOLAIR MAGDRIVE PUMPS

- Magnetically driven pumps with no shaft seal • Pumps are not self-priming and require suction
- Pumps have run dry and thermal overload protection

Item	Model	Type	GPH	Inlet	Outlet	Specify	Voltage	Draw @ 115 VAC	Max PSI	Ship	Net
901778	PM500	Submersible	510	3/4"	1/2"	115 or 230 VDC	115 or 230 VDC	2.0 A	8.2	9 lbs	\$284.99
901779	PM1000	Non-submersible	1032	1"	1/2"	115 or 230 VDC	115 or 230 VDC	1.6 A	11.7	9 lbs	324.99

2 Year Warranty!



PM500

PM1000

### CAL MARINE WATER CIRCULATION PUMPS

- For below the waterline installations • Premium Stainless Steel and bronze construction • Includes 6' power cord
- Extremely quiet operation • For fresh or salt water applications • Use submerged or in open air
- Thermally protected • Complies with ABYC standards • Nylon mounting bracket standard, stainless steel available

Item	Model	GPH	Intake	Discharge	Specify	Voltage	Ship	Starting At
502712	MS320-6	320	1/2" MNPT	1/4" MNPT	115 or 230 VAC	115 or 230 VAC	6 lbs	\$157.99
502713	MS580-6	580	3/4" MNPT	1/2" MNPT	115 or 230 VAC	115 or 230 VAC	9 lbs	234.99
502714	MS900-6	900	3/4" MNPT	1/2" MNPT	115 or 230 VAC	115 or 230 VAC	9 lbs	233.99
502715	MS1200-6	1200	3/4" MNPT	1/2" MNPT	115 or 230 VAC	115 or 230 VAC	9 lbs	243.99

2 Year Warranty!



### LITTLE GIANT MAGNETIC DRIVE PUMPS

- Leak-proof, seal-less magnetic drive designed for non-submersible use • Pumping heads are easily rotated, cleaned or serviced with no special tools
- Thermally protected, open, fan cooled motor • Supplied with 6' power cord with 3-prong plug

Item	Model	GPH	Intake	Discharge	Voltage	Max Temp	Max Pressure	Max Current	Ship	Net
502922	2-MD-SC	510	1/2"	1/2"	115 VAC	150°F	6.3 PSI	1.43 A	6 lbs	\$209.99
	2-MD-SC	510	1/2"	1/2"	230 VAC	150°F	6.3 PSI	0.64 A	6 lbs	241.99
502923	3-MD-SC	750	3/4"	1/2"	115 VAC	150°F	9.5 PSI	2.40 A	9 lbs	241.99
	3-MD-SC	750	3/4"	1/2"	230 VAC	150°F	9.5 PSI	1.20 A	9 lbs	277.99
502924	5-MD-SC	1050	1"	1/2"	115 VAC	150°F	11.9 PSI	2.00 A	9 lbs	382.99
	5-MD-SC	1050	1"	1/2"	230 VAC	150°F	11.9 PSI	1.10 A	9 lbs	430.99

1 Year Warranty!



581503

### IWAKI MAGNETIC DRIVE RAW WATER PUMPS

Ideal for supplying water to Webasto AC/Reverse cycle heat units. Twin bearing system handles thrust loads and extends service life. Rotating, internal cooling circuit reduces bearing temperature. 115 VDC, non-metallic case and compact/quiet energy efficient design. Install below the waterline.

Item	Model	GPH	Inlet	Discharge	Voltage	Motor Output	Motor Speed	Current	Max Head	Ship	Net
501354	MD-15RT-115NL	300	1/2"	1/2"	115 VDC	1/75 HP	3100 RPM	0.29 A	11.1'	5 lbs	\$186.99
501355	MD-20RT-115NL	492	5/8"	3/4"	115 VDC	1/38 HP	3100 RPM	0.48 A	14.1'	6 lbs	213.99
501356	MD-30RT	600	3/4"	3/4"	115 or 220 VDC	1/16 HP	3150 RPM	1.0/0.40 A	17.7'	9 lbs	283.99
501357	MD-40RT	822	3/4"	3/4"	115 or 220 VDC	1/12 HP	3200 RPM	1.3/0.82 A	21.3'	10 lbs	357.99
502321	MD-70-RT	1536	1"	1"	115 or 220 VDC	1/4 HP	3400 RPM	2.80 A	31.8'	16 lbs	443.99
502322	MD-100-RT	2136	1"	1"	115 or 220 VDC	1/3 HP	3400 RPM	3.40 A	39'	22 lbs	534.99

1 Year Warranty!



### JABSCO MAGNETICALLY COUPLED CENTRIFUGAL PUMP

- Designed for applications requiring safe, leak-free, continuous duty pumping
- Typical applications include marine air conditioner circulation, ice makers, hot water circulation, livewell or bait tank installations
- Pumphead manufactured in chemical resistant thermo-plastics
- Magnetic couplings provide an energy efficient thermal shield, minimizing heat transfer to the pumped fluid

Item	Model	GPH	Inlet	Discharge	Voltage	Motor Output	Fuse	Current	Max Head	Ship	Net
502380	436977	630	1/2"	1/2"	110 VAC	30 W	1.0 A	0.75 A	14'	8 lbs	\$243.99
502381	436979	792	1/2"	1/2"	110 VAC	60 W	1.0 A	0.95 A	19'	8 lbs	256.99
502382	436981	1260	3/4"	3/4"	110 VAC	60 W	1.5 A	1.40 A	18'	8 lbs	324.99

2 Year Warranty!



### OBERDORFER CENTRIFUGAL SELF-PRIMING AIR CONDITIONING PUMP

- Rugged bronze construction • Self-priming to 20 ft. suction lift • Extremely quiet operation
- O-ring housing seal eliminates gasket problems • 316 stainless steel shaft • Discharge port orientation flexibility (8 positions)
- Auxiliary connections for convenient priming and draining • Multiple mechanical shaft seal options for various applications
- Pump heads mount to standard-footed NEMA 56j jet pump motors

Item	Model	GPH	Port Size	Voltage	Ship	Net
901397	300B-F13	1320	1"	115/230 VAC 50/60Hz	34 lbs	\$929.99

1 Year Warranty!



### OBERDORFER 104M CENTRIFUGAL AIR CONDITIONING PUMP

- Rugged bronze construction • Extremely quiet operation • 316 stainless steel shaft
- Mechanical-type shaft seal with Buna rubber element suitable for water, oils and some mild solvents
- Applications include: Marine air conditioning, engine block temperature control, radiator and heat exchanger circulation, baitwell circulation

Item	Model	GPH	Inlet	Outlet	Voltage	Max Liquid Temp	Ship	Net
901396	104M-F13	1440	3/4"	1/2"	115/230 VAC 50/60Hz	212°F	27 lbs	\$749.99

1 Year Warranty!



### OBERDORFER 107M CENTRIFUGAL AIR CONDITIONING PUMP

- Rugged bronze construction • Extremely quiet operation • 316 stainless steel shaft
- Mechanical-type shaft seal with Buna rubber element suitable for water, oils and some mild solvents
- Applications include: Marine air conditioning, engine block temperature control, radiator and heat exchanger circulation, baitwell circulation

Item	Model	Specify	GPH	Inlet	Outlet	Voltage	Max Liquid Temp	Ship	Net
901383	107MA-F25/107MB-F25		1950 or 2100	1-1/4"	1"	115/230 VAC 50/60Hz	212°F	33 lbs	\$799.99

1 Year Warranty!





### AC Accessories



Item	Model	Description	Ship	Net
901618	Specify: Black or White	4" Round plastic outlet/vent	1 lbs	\$12.99
901615	TB66-4B	Round Black plastic transition box; 6" x 6"; outlet 4"; back entry	1 lbs	46.99
901614	TB84-5S	Flat oval, Black plastic transition box; 8" x 4"; side entry; outlet 5"	1 lbs	44.99
901613	TB84-4B	Flat oval, Black plastic transition box; 8" x 4"; back entry; outlet 4"	1 lbs	34.99
901608	PG8X4R	White plastic supply air vent/grill; 8" x 4"; fixed blades	1 lbs	54.99
901609	Specify size:	Teak supply air vent/grill, fixed blades	1 lbs	79.99
	Specify: 6" x 6" or 8" x 4"			
901775	Specify size:	White air return vent/grill; fixed blades	2 lbs	79.99
	Specify: 10" x 10" or 14" x 10"		2 lbs	84.99
901776	Specify size:	Teak air return vent/grill; 11" x 8" fixed blades	1 lbs	84.99
	Specify: 14" x 10" or 11" x 8"		2 lbs	94.99
901616	Specify size:	Black plastic "Y" air duct splitter/divider	1 lbs	59.99
	4" Inlet 3" & 3" Outlets, 4" Inlet 4" & 4" Outlets, 5" Inlet 4" & 4" Outlets, 5" Inlet 5" & 4" Outlets, 5" Inlet 5" & 5" Outlets			



### Heater Accessories

#### WEBASTO HIGH TEMPERATURE THREADED DUCT OUTLET WITH ADJUSTABLE LOUVERS

Specify Color: Black, Gray or White

Item	Size	Ship	Net
901683	60 mm	1 lbs	\$11.99
	90 mm	1 lbs	26.99

#### WEBASTO HIGH TEMPERATURE "Y" DUCT ADAPTER

Specify: 55/55/55 mm, 80/55/55 mm, 80/60/60 mm, 80/80/80 mm, 90/80/80 mm, 90/90/90 mm

Item	Ship	Starting at
901677	1 lbs	\$9.99

#### WEBASTO HIGH TEMPERATURE DUCT BRANCH ADAPTER

Item	Size	Ship	Net
901678	60/60/60 mm	1 lbs	\$13.99
	90/90/60 mm	1 lbs	15.99

#### WEBASTO HIGH TEMPERATURE AIR DUCT "T"

Item	Size	Ship	Net
901679	60/60/60 mm	1 lbs	\$11.99
	90/90/90 mm	1 lbs	17.99

#### WEBASTO HIGH TEMPERATURE STRAIGHT DUCT CONNECTOR

Specify: 55 mm duct/55 mm length, 60 mm duct/50 mm length, 80mm duct/75 mm length, 90 mm duct/50 mm length

Item	Ship	Starting at
901680	1 lbs	\$10.99

#### WEBASTO HIGH TEMPERATURE THRU-WALL THREADED DUCT ADAPTER

Item	Size	Ship	Net
901682	60 mm	1 lbs	\$10.99
	90 mm	1 lbs	12.99

#### WEBASTO HIGH TEMPERATURE THRU WALL SNAP-ON DUCT ADAPTER

Item	Size	Ship	Net
901681	60 mm	1 lbs	\$10.99
	90 mm	1 lbs	10.99

### DOMETIC Dual Duct Kit

- Dual-duct kit for A/C systems requiring an additional air outlet
- Dual-duct kit is available for 9K - 16K BTU/hr EnviroComfort (ECD) and EnviroCool (CM) models

#### Kit Includes:

- 4" Round white grille (1)
- 4" Insulated ducting (12.5 feet)
- Y Duct 6" x 6" x 4" (1)

Item	Model	Description	Ship	Net
900829	226600092	2.36" Dia. x 9.84' L	7 lbs	\$154.99

### Webasto Flex Pack Heat Duct Tubing

Ducting material used to connect the heater to the outlets for the distribution of the circulated air from the heater fan.

Item	Model	Description	Ship	Net
901777	5000692A	2.36" Dia. x 9.84' L	5 lbs	\$64.99
	5000317A	2.36" Dia. x 16.4' L	7 lbs	99.99
	5000753A	3.54" Dia. x 16.4' L	8 lbs	154.99

### Air Purifiers

### DOMETIC Breathe Easy Portable Air Purifier

Reduce the odors of tobacco smoke, mildew, mustiness, chemical vapors and toilets, and inhale fresher, cleaner, healthier air. Effective in areas up to 4,000 cubic ft., the portable Breathe Easy air purifier uses innovative Photocatalytic Nano-Mesh technology with ultraviolet (UV) light to improve air quality. The UV bulb inside uses a specific frequency of light that produces no harmful ozone. The unit operates quietly and has two fan-speed settings.



- Power: 12 VDC and 115/220/230 VAC
- Dimensions: 6.25" W x 4.5" D x 1.75" H
- Effective in areas up to 4,000 cu. ft.
- Cleaner air may lessen allergy and asthma symptoms
- Up to 96% reduction in volatile organic compounds (VOCs)
- Up to 99% reduction in bacteria, fungi, mold and pollen
- Worldwide AC power adapter with plugs and 12 VDC power plug included

Item	Model	Ship	Net
402297	4210805	2 lbs	\$99.99
401399	4210804 Service kit	1 lbs	54.99

### Odor & Mold Control

### Caframo 9406 Stor-Dry Air Circulator

- Combats mold, mildew and musty odors in areas up to 1000 cubic feet
- Power: 120 VAC
- Color: Silver
- Corrosion resistant aluminum
- No maintenance required
- Power consumption: 70 Watts
- Dimensions: 10" W x 4.75" H x 10" D
- Draw: .65 Amps
- LED indicator light
- 2 year warranty



Item	Model	Ship	M.A.P.
900025	9406CAABX	3 lbs	\$69.99

### Davis Air-Dryer 1000

- Handles up to 1000 cubic feet of living space
- Circular unit measures 13.5" in diameter and 4.25" high
- Draws only 1.1 amps, 130 watts
- UL Listed
- Silent operation - no switch, fan or thermostat; uses natural convection to circulate the air



Item	Model	Ship	Net
754124	1458	3 lbs	\$59.99

### DOMETIC Breathe Easy Air Filter

- MERV 7 air filtration for Dometic, Cruisair and Marine Air A/C units
- Fits select Dometic EnviroComfort models
- Captures diesel smoke, dust, lint, bilge odors and pet dander



#### Please Specify Model

Item	Model	For	Ship	Net
901528	235000600	600: For ECM5 Or ECD5	1 lbs	\$32.99
	235000601	601: For ECM6.5 Or ECD6.5	1 lbs	32.99
	235000603	603: For ECM9 Or ECD9	1 lbs	59.99
	235000605	605: For ECM11 Or ECD11	1 lbs	38.99
	235000606	606: For ECM15 Or ECD15	1 lbs	38.99

### Duct Hose



### Trident Heating and A/C Duct Hose

- Thermo-efficient insulated
- Black CPE core (bonded to coated wire helix) easily expands over fittings and supports thick blanket of fiberglass insulation

- #471 has fiberglass reinforced metallized cover
- Rated R-4.2
- Operating temperatures -20° to +250°F (-29° to +121°C)
- Meets UL 181, NFPA 90A and 90B
- 2 Year warranty

Item	Model	Description	Ship	Net
901774	471-400	4" Dia. x 25' L	6 lbs	\$65.99
	471-500	5" Dia. x 25' L	8 lbs	75.99
	471-600	6" Dia. x 25' L	9 lbs	99.99
	471-700	7" Dia. x 25' L	11 lbs	106.99

❖ For more detailed product specifications and our complete selection visit [www.defender.com](http://www.defender.com) or call 800-628-8225. ❖



# Webasto Marine Air Heating Systems

Webasto Marine Air Heaters provide a better solution to boaters who require the ultimate in compartment and cabin heating. They operate up to 20 hours on a single gallon of fuel and are a quiet and powerful source of heat on any vessel.

## BLUEHEAT HEATING SOLUTIONS

### Kits include:

- Heater and controller
- Thru-hull exhaust fitting
- Documentation
- Fuel pump in enclosure
- Fuel line
- Mounting bracket and hardware
- Ducting and connectors
- Exhaust water trap

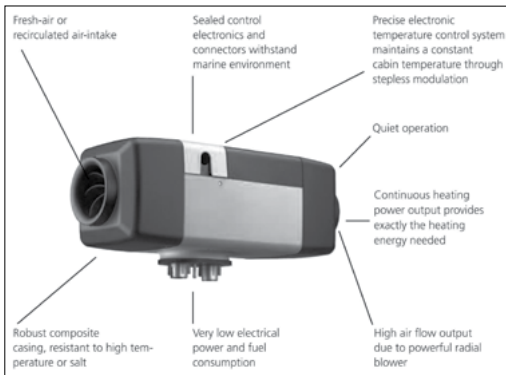
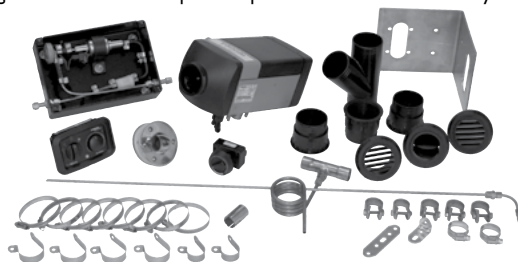

Item	Model	Heat output (kW) • PLUS**	Fuel consumption (PLUS)	Rated VDC	Air Flow against 0.5 bar (PLUS)	Power consumption	Weight	Dimensions L x D x H	Controller	Ship	Net
901715	Air Top 2000ST	0.9-2.0 kW / 3,000 - 7,000 BTU	Diesel, 0.12-0.24 l/h / 0.03-0.06 g/h	12	78 m <sup>3</sup> /h / 46 cfm	14-29 Watts	5.74 lbs	12.5" x 4.78" x 4.84"	SmartTemp Controller	74 lbs	\$2354.99
901716	Air Top Evo 40	1.5-3.5 kW / 5,100 -12,000 BTU • 3.9 kW /13,300 BTU	Diesel, 0.17-0.42 (0.47) l/h / 0.04-0.11 (0.12) g/h	Specify 12 or 24	140 (155) m <sup>3</sup> /h / 77.7 (91) cfm	15-40 Watts	13 lbs	16.65" x 5.83" x 6.38"	Evo M Controller	115 lbs	Starting at \$2924.99
901717	Air Top Evo 55	1.5-5.0 kW / 5,100 - 17,000 BTU • 5.5 kW /18,700 BTU	Diesel, 0.17-0.60 (0.66) l/h / 0.04-0.15 (0.17) g/h	Specify 12 or 24	200 (220) m <sup>3</sup> /h / 117.7 (129.4) cfm	15-95 Watts	13 lbs	16.65" x 5.83" x 6.38"	Evo M Controller	115 lbs	Starting at \$3199.99

## Propane Cabin Heaters

### DICKINSON NEWPORT COMPLETE FIREPLACE KIT

- Stainless steel with a built-in blower
- Safe and efficient
- Large viewing window
- Thermocouple protection and a sealed combustion chamber
- Burns 1 lbs of fuel in 7 hrs!
- Heater/fireplace on the boat!

Comes with Stainless steel backing plate and 28" of flexible, double Stainless chimney. Maximum exhaust stack is 56". Easy to install and use. P9000 Output: 3,200 - 4,500 BTUs P12000 Output: 4,000 - 5,500 BTUs Uses 2.5" diameter components.



Item	Model	Dimension H x W x D	Heats Room	Ship	Net
901436	00-NEW-P9000	14" x 8.5" x 5.5"	10' x 10' x 8'	22 lbs	\$849.99
901437	00-NEW-P12000	16" x 10" x 7.25"	12' x 12' x 8'	31 lbs	944.99

### 20' PROPANE HOSE

Item	Model	Description	Ship	Net
400587	19-100-20	20' Hose with 3/8" female flare	3 lbs	\$59.99

### SIG MARINE COZY CABIN HEATER

- Small but powerful bulkhead mounted propane cabin heater
- Provides lots of vented heat with a bright element
- Brass accents and a cast metal cooktop
- A thermocoupler interrupts gas flow if burner is extinguished
- Burns about 1 lbs propane in 3 hrs. at high setting



Item	Model	Dimension H x W x D	BTUs	Ship	Net
900715	10000	16" x 8" x 7.25"	5500	10 lbs	\$529.99

## Solid Fuel Cabin & Alcohol Heater

### DICKINSON NEWPORT SOLID FUEL HEATER

- Manufactured from stainless steel
- Output: 3,000 - 8,000 BTUs
- Versatile combustion: Wood, coal, pellets, charcoal, presto-log
- Bulkhead mounted
- 3" dia. chimney accessories required

Item	Model	Dimensions H x W x D	Ship	Net
900697	00-NEWSF	14.75" x 7.88" x 10"	14 lbs	\$446.99



### DOMETIC (FORMERLY ORIGO) HEAT PAL 5100

- Doubles as a stove
- Non-pressurized
- 1 Quart (1.27L) fuel capacity
- Safe and easy to use
- 5 hrs. of burn time at max heat

Item	Model	Description	Ship	Net
900712	5100	5200 BTU/hr, 11.5" W x 11.5" H*	6 lbs	\$179.99
900099	1000-51	Replacement fuel canister	2 lbs	134.99



\*6"H (stove) with lid removed

### KLEAN-STRIP DENATURED ALCOHOL

Produces a hot, clean, odorless and smokeless flame in alcohol stoves.

Item	Size	Ship	Net
756800	Qt	2 lbs	\$6.99
	Gal	8 lbs	17.99

## Engine/Bilge Heaters

### CAFRAMO PALI ENGINE COMPARTMENT HEATER

- Extend your boating season and protect your engine against surprise cold snaps
- Single speed, omnidirectional airflow
- Self-regulating PTC heating element that cannot overheat
- Internal hermetically sealed thermostat turns heater on at 41° F and off at 59° F
- Includes 20' power cord and quick release bracket

2 Year Warranty!



Item	Model	H x W x D	BTUs	Watts	Power	Ship	Net
901645	9510CABBX	5" x 9" x 5"	1365	400	120 VAC, 60 Hz	5 lbs	\$219.99

## Electric Heaters

### CAFRAMO DELTAMAX CERAMIC HEATER

- Features high and low heat settings (750 W and 1500 W)
- Equipped with overheat protection and automatic shut off to provide peace of mind
- Automatic shut off if heater is tipped over
- Rugged protective frame
- Built-in adjustable thermostat
- PTC ceramic heating element
- Power indicator light
- Housing color: Black
- Warranty 1 year



Item	Model	Dimensions	Ship	Net
901757	9315CABBX	7.1" L x 6.9" W x 7.3" H	5 lbs	\$39.99

### HEATER CRAFT MARINE HEATER KITS-12 VDC

- Delivers generous amounts of heat
- Hose barb: 5/8"
- Fits boats with I/O or inboard engines
- Black grill



Housing and grill constructed of heavy-duty marine grade aluminum and powder coated to prevent corrosion. Includes: (1) Heater unit with wire harness, (4) #8 stainless steel hose clamps, (1) flush mount grill, (1) 4 position switch and mounting plate, (2) 6' lengths of 1/6 gauge wire, (6) Brass fittings for universal installation and (1) 50' x 5/8" 150 PSI heater hose.

Item	Model	Grill H x W	BTUs	Ship	Net
901148	500 PRO	7.45" x 11.3"	28,000	35 lbs	\$429.99
901149	400 PRO	8.5" x 17.5"	40,000	38 lbs	499.99

### HEATER CRAFT 12 VDC MARINE HEATER KIT

- 8% faster due to the new 45° face without increasing amp draw or motor size
- 3% Lighter than previous models



Includes: Heater, 45° wrapper with wire harness, universal mounting brackets and screws, heavy duty wire ties, high low switch with indicator assembly, (6) stainless steel hose clamps, 1/6 gauge wire, Hot Tube™ and fixed louver with chrome ring, 50' of heater hose, Low Idle "Y", brass fittings and detailed installation manual.

Item	Model	Description	BTUs	Ship	Net
901150	200 PRO	(1) Fixed louver and (1) Hot Tube™ with (1) chrome ring	28,000	28 lbs	\$499.99
901151	300 PRO	(1) Fixed louver and (2) Hot Tubes with (2) chrome rings	40,000	30 lbs	649.99

### TRUE NORTH CABIN HEATER

- For use in dry, indoor environments
- Low-profile design prevents tip over
- CSA approved
- 120V / 60Hz
- Antifreeze setting
- Powder coated finish
- Standard household plug
- Fan only option
- Thermostat control: 3 heat settings: 600 / 900 / 1500 Watts



Item	Model	Ship	Net
900024	9206CABBX	7 lbs	\$79.99

5 year warranty!



Visit [www.defender.com](http://www.defender.com) for parts & accessories.

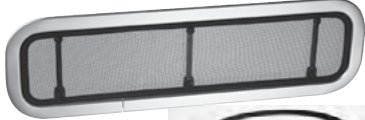

**NEW!**

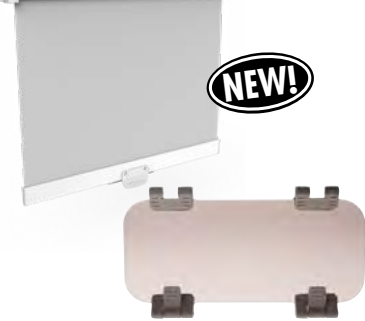

**BOMAR**  
**BOMAR**

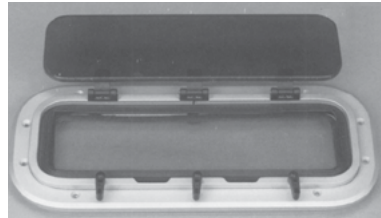

**Vetus**



**Lewmar Standard Portlights**

Popular friction hinge provides a choice of open positions. Corrosion-free hinges are made of glass-reinforced nylon. Easy to install. Ivory interior trim and anodized aluminum frame come complete with anti-vibration handles, insect screen, trim, screws and fitting instructions.

Item	Model	Size	Lens Color	Frame Size	Cutout	Cutout Radius	Ship	Net
900358	393022500	0	Clear	6-15/16" x 12-11/16"	6-1/8" x 11-15/16"	2-1/16"	4 lbs	\$189.99
900362	393122500	1	Clear	7-1/2" x 14-7/16"	6-3/4" x 13-11/16"	2-1/16"	4 lbs	208.99
900366	393222500	2	Clear	6-15/16" x 16-3/4"	6-1/8" x 15-5/16"	2-1/16"	4 lbs	244.99
900370	393322500	3	Clear	7-1/2" x 17-11/16"	6-3/4" x 16-7/8"	2-1/16"	5 lbs	306.99
900374	393422500	4	Clear	7-1/2" x 25-7/16"	6-3/4" x 24-11/16"	2-1/16"	7 lbs	358.99
900360	393020500	0	Smoke	6-15/16" x 12-11/16"	6-1/8" x 11-15/16"	2-1/16"	4 lbs	189.99
900365	393120500	1	Smoke	7-1/2" x 14-7/16"	6-3/4" x 13-11/16"	2-1/16"	4 lbs	208.99
900368	393220500	2	Smoke	6-15/16" x 16-3/4"	6-1/8" x 15-5/16"	2-1/16"	4 lbs	244.99
900372	393320500	3	Smoke	7-1/2" x 17-11/16"	6-3/4" x 16-7/8"	2-1/16"	5 lbs	306.99
900376	393420200	4	Smoke	7-1/2" x 25-7/16"	6-3/4" x 24-11/16"	2-1/16"	7 lbs	358.99

**Lewmar Standard Port Screens**

The flyscreen is made from nylon mesh with a molded frame which clips onto the portlight outer frame. Flyscreen can be left in position when the window is closed. Just match the size of the fly screen to the size of your portlight.

Item **901798** Specify Size: 0, 1, IRE, 2, 3, 4, 5, 7RE Starting at \$42.99

**Lewmar Replacement Port Seals**

Color: Black • Opening version only  
 Item **901808** Pre 1997 ports, Specify Size: 0, 1, 2, 3, 4, 4L, 4R, 5 Starting at \$14.99  
 Item **901807** 1998 - present ports, Specify Size: 0, 1, 2, 3, 4, 4L, 4R, 5, IRE, 7RE Starting at 37.99

**Lewmar Eclipse Port Shade**

- 100% blackout material is UV stable
- Excellent resistance to damp conditions
- Perfect solution to light protection
- Easy to assemble with 2 simple parts (Requires 6 screws - not included)
- Color: White

Item **901841** Specify Size: 0, I/IRE, 2/3/5, 4R/4L Starting at \$50.99

**Lewmar Standard Replacement Lens for Lewmar Opening Portlight**

• Applications: Lewmar portlights (1998 to present) • Material: Acrylic • Color: Clear or Gray

Item	Model	Size	Color	Ship	Net	Item	Model	Size	Color	Ship	Net
901839	360750009	0	Gray	2 lbs	\$84.99	901839	360752209	2	Clear	2 lbs	\$136.99
	360750209	0	Clear	2 lbs	99.99		360753009	3	Gray	2 lbs	105.99
	360751009	1	Gray	2 lbs	89.99		360753209	3	Clear	2 lbs	113.99
	360751209	1	Clear	2 lbs	101.99		360754009	4	Gray	3 lbs	122.99
	360752009	2	Gray	2 lbs	90.99		360754209	4	Clear	3 lbs	122.99

**Bomar 2000 Series Extruded Portlights**

• Features anodized extruded aluminum frame and smoked acrylic lens • CE approved (area 1) • Adjustable quick dog; deep drain angle  
 • No visible exterior screws. Please note: These portlights fit 1/4" to 7/8" hull thickness. 7/8" through 1-7/16" sizes are available by special order. Contact Pompanette (603) 826-5791 to get the model # you need, then contact us for your price. Includes trim ring and screens.

Item	Model	Shape	Trim O.D.	Cutout	Cutout Radius	Ship	Net
901223	N2410	Rectangle	7-1/16" x 12-15/16"	6-1/8" x 12"	2-1/32"	5 lbs	\$207.99
901224	N2414	Rectangle	7-1/16" x 16-7/8"	6-1/8" x 15-15/16"	2-1/32"	6 lbs	219.99
901225	N2512	Rectangle	7-3/4" x 14-11/16"	6-13/16" x 13-3/4"	2-1/32"	5 lbs	219.99
901226	N2515	Rectangle	7-11/16" x 17-13/16"	6-3/4" x 16-7/8"	2-1/32"	6 lbs	228.99
901227	N2523	Rectangle	7-11/16" x 25-5/8"	6-3/4" x 24-11/16"	2-1/32"	8 lbs	269.99
901228	NC2514-OV	Oval	7-11/16" x 16-15/16"	6-3/4" x 16"	N/A	6 lbs	479.99

**Bomar Gray Series Molded Portlights**

• Stainless steel hardware • Angled spigot (except 310, 414-sd) • Complete with trim ring and screen  
 • White frame with clear lens standard (310 model has tinted lens) • A=Angled spigot, AD= Angle drain, SD= Straight spigot

Item	Model	Opening Size	Cutout	O.D. Base	Spigot Length	Ship	Net
901000	G310---28	2-7/8" x 9-7/8"	3-1/2" x 10-3/8"	5-1/2" x 12-3/8"	1"	3 lbs	\$112.99
900501	G410-A-27	3-3/4" x 9-1/2"	4-5/8" x 10-7/16"	6-9/16" x 12-1/2"	1-15/16"	3 lbs	136.99
900503	G414-A-27	3-3/8" x 13-3/8"	4-1/2" x 14-1/2"	6-1/2" x 16-1/2"	1-7/8"	4 lbs	149.99
900505	G414-SD27	3-3/8" x 13-3/8"	4-1/2" x 14-1/2"	6-1/2" x 16-1/2"	1-7/8"	4 lbs	149.99
900507	G512-AD27	4" x 11"	5-1/2" x 12-1/2"	7-13/16" x 14-11/16"	2-3/8"	4 lbs	158.99
900509	G715-AD27	6" x 14"	7-9/16" x 15-1/2"	9-5/8" x 17-3/4"	1-7/8"	5 lbs	179.99
900511	G818-AD27	7" x 17"	8-1/2" x 18-7/16"	10-11/16" x 20-5/8"	1-7/8"	6 lbs	181.99
990041	G724-AD27	6" x 23"	7-9/16" x 24-1/2"	9-7/8" x 26-3/4"	1-7/8"	6 lbs	228.99

**Vetus Portholes**

Vetus' new line of portholes feature sleek anodized aluminum frames and smoked colored panes. These new portholes are fitted with friction type hinges permitting them to stay open in any position. Two large diameter clamp knobs ensure that the portholes can be closed making them completely water tight. Optional mosquito screens are available at [defender.com/vetus.jsp](http://defender.com/vetus.jsp)

Item	Model	Shape	Frame Size	Cutout	Cutout Radius	Ship	Net
901780 Specify Size	PA3016	Rectangle	12-3/8" x 7-1/8"	11-11/16" x 6-3/8"	2-1/4"	4 lbs	\$146.99
	PA3517	Rectangle	14-1/2" x 7-5/8"	13-3/4" x 6-7/8"	2-1/4"	4 lbs	159.99
	PA4116	Rectangle	16-7/8" x 7-1/8"	16-11/16" x 6-3/8"	2-1/4"	4 lbs	179.99
	PA4317	Rectangle	17-5/8" x 7-5/8"	17-1/8" x 6-7/8"	2-1/4"	5 lbs	194.99
	PA6317	Rectangle	25-1/2" x 7-5/8"	25" x 6-7/8"	2-1/4"	7 lbs	214.99
901781 Specify Size	PM113	Oval	9-5/8" x 5-3/4"	8-11/16" x 4-13/16"	2-3/8"	5 lbs	144.99
	PM123	Oval	11-9/16" x 6-3/4"	10-5/8" x 5-13/16"	2-15/16"	5 lbs	154.99
	PM133	Oval	13-9/16" x 7-13/16"	12-5/8" x 6-7/8"	3-7/16"	5 lbs	164.99
	PM143	Oval	14-1/4" x 5-3/4"	13-5/16" x 4-13/16"	2-3/8"	5 lbs	174.99
	PM153	Oval	15-3/8" x 8-11/16"	14-7/16" x 7-11/16"	3-7/8"	7 lbs	179.99
901782 Specify Size	PW201	Round	7-13/16"	6-7/8"	NA	5 lbs	199.99
	PW211	Round	8-11/16"	7-11/16"	NA	5 lbs	184.99
	PW221	Round	10-1/4"	9-5/16"	NA	6 lbs	189.99





**BECKSON RAIN DRAIN OPENING PORTS**

Primarily for installations where cabin sides are inclined at angles greater than 15° from vertical and where ports collect rain and spray. These ports have 2" spigots. When cut to flush and installed in hulls up to 5/8" thick they drain, even when tipped at angles up to 45°. Molded of strong, UV resistant marine plastic with Lexan windows. Trim rings and screens are included. Use trim ring as template. Use silicone caulk only. For exact cutout use trim ring as template plus 1/16" for bedding. Add 2" spigot length to these dimensions. Ex "5-1/2" x 12-3/8" x 2"

Item	Model	Frame Size	Cutout	Frame Color	Lens	Ship	Net
901814	PO310-DW	5-1/2" x 12-3/8"	3-1/2" x 10-3/8"	White	Clear or smoke	3 lbs	\$127.99
901813	PO410-DW	6-3/4" x 12-3/4"	4-1/2" x 10-1/2"	White	Clear or smoke	3 lbs	141.99
901810	PO414-DW	6-3/4" x 16-3/4"	4-3/4" x 14-1/2"	White	Clear or smoke	4 lbs	162.99
901811	PO512DW-20	7-3/4" x 14-5/8"	5-1/2" x 12-1/2"	White	Clear or smoke	4 lbs	162.99
901812	PO714-DW	9-3/4" x 16-3/4"	7-1/2" x 14-3/8"	White	Clear or smoke	5 lbs	199.99
900307	PO310DBS-20	5-1/2" x 12-3/8"	3-1/2" x 10-3/8"	Black	Smoke	3 lbs	127.99
900315	PO410DBS-20	6-3/4" x 12-3/4"	4-1/2" x 10-1/2"	Black	Smoke	3 lbs	141.99
900311	PO414DBS-20	6-3/4" x 16-3/4"	4-1/2" x 14-1/2"	Black	Smoke	4 lbs	162.99
900309	PO512DBS-20	7-3/4" x 14-5/8"	5-3/4" x 12-1/2"	Black	Smoke	4 lbs	162.99
900313	PO714-DBS-20	9-3/4" x 16-3/4"	7-1/2" x 14-3/8"	Black	Smoke	5 lbs	199.99

**BECKSON NEWPORT SELF DRAIN™ OPENING PORT**

Innovatively designed with an angled drainage ramp molded on the inside of the spigot. This design promotes drainage without having the hassle of making angled cuts in the hull. This also allows for thru-bolting which is impossible in windows where an angled spigot extends below the bolt holes. The internal angle seats tightly against the gasket and lens. Self drain opening ports are ideal for mounting where installation is within 15° of vertical (with spigot length up to 1").

Item	Model	Frame Size	Cutout	Frame Color	Specify Lens	Ship	Net
901662	PO410-W	6-3/4" x 12-3/4"	4-1/2" x 10-1/2"	White	Clear or smoke	3 lbs	\$135.99
901663	PO410-B	6-3/4" x 12-3/4"	4-1/2" x 10-1/2"	Black	Clear or smoke	3 lbs	135.99
901664	PO414-W	6-3/4" x 16-3/4"	4-1/2" x 14-1/2"	White	Clear or smoke	3 lbs	159.99
901665	PO414-B	6-3/4" x 16-3/4"	4-1/2" x 14-1/2"	Black	Clear or smoke	3 lbs	159.99
901666	PO512-W	7-3/4" x 14-5/8"	5-3/4" x 12-1/2"	White	Clear or smoke	3 lbs	159.99
901667	PO512-B	7-3/4" x 14-5/8"	5-3/4" x 12-1/2"	Black	Clear or smoke	3 lbs	159.99
901668	PO714-W	9-3/4" x 16-3/4"	7-1/2" x 14-3/8"	White	Clear or smoke	4 lbs	189.99
901669	PO714-B	9-3/4" x 16-3/4"	7-1/2" x 14-3/8"	Black	Clear or smoke	5 lbs	189.99

**BECKSON 8" ROUND OPENING PORTS**

Item	Model	Cutout Dia.	Frame Dia.	Spigot	Frame Color	Lens	Ship	Net
901809	PO8RD-WC-20	8-1/2"	10-3/4"	2"	White	Clear	3 lbs	\$147.99
	PO8RD-BS-20	8-1/2"	10-3/4"	2"	Black	Smoke	3 lbs	147.99

**BECKSON ROUND FIXED PORTS**

Item	Model	Cutout Dia.	Frame Dia.	Frame Color	Lens	Ship	Net
900336	PF4RD-WC	4-5/8"	6-1/8"	White	Clear	1 lbs	\$21.99
900337	PF6RD-WC	6-1/2"	8-1/8"	White	Clear	1 lbs	28.99
900056	PF8RD-BS	8-1/2"	10"	Black	Smoke	1 lbs	42.99

**BECKSON PORTLIGHT REPLACEMENT LENS**

(2) bolts and (2) nuts included.

Please specify lens: Clear or smoke.

Item	Model	Size	Fits	Ship	Net
901815	LNZ-310	3" x 10"	310, 1982 and up	1 lbs	\$39.99
	LNZ-410	4" x 10"	410, 1982 and up	1 lbs	41.99
	LNZ-414	4" x 14"	414, 1982 and up	1 lbs	46.99
	LNZ-512	5" x 12"	512, 1982 and up	1 lbs	46.99
	LNZ-714	7" x 14"	714, 1982 and up	2 lbs	56.99

**BECKSON CAM LATCHES**

- Ports can opened or closed with a flip • Stronger than knobs or levers
- Assemblies include pins and 1/4 x 20 toggles
- Self-lubricating, non-fouling and resists vibration
- Positive closures adjust in increments of 90°

Item	Specify Color	Ship	Net/Pair
900579	White or Black	1 lbs	\$18.99

**BECKSON INTERNAL RAIN SHIELD**

- Allows windows to be left open for fresh air to circulate during all weather conditions
- Open louvered designs for maximum ventilation
- Heat-repelling smoked lens

Item	Model	Size	Louvers	Ship	Net/Ea.
901787	IRS-310S	3" x 10"	Single	1 lbs	\$51.99
	IRS-410S	4" x 10"	Single	1 lbs	56.99
	IRS-414S	4" x 14"	Double	1 lbs	61.99
	IRS-512S	5" x 12"	Double	1 lbs	61.99
	IRS-714S	7" x 14"	Double	2 lbs	72.99

**BECKSON OPENING PORTS EXTERNAL RAIN SHIELDS**

May be fastened by screws or by bonding to the exterior trim ring of opening ports. Keeps out rain and spray and provides shade.

Item	Model	Fits	Ship	Net
901788	RS-10	3" x 10" and 4" x 10"	1 lbs	\$26.99
	RS-12	5" x 12"	1 lbs	31.99
	RS-14	4" x 14" and 7" x 14"	1 lbs	34.99
	RS-18	8" x 18"	1 lbs	41.99

**BECKSON PORT SCREENS**

For opening ports.

Item	Model	Fits Series	Screen OD	Ship	Net
901749	SCR-310	PO310	2-15/16" x 10-1/4"	1 lbs	\$14.99
	SCR-410	PO410	4-1/4" x 10-1/2"	1 lbs	16.99
	SCR-414	PO414	4-1/4" x 14-1/2"	1 lbs	18.99
	SCR-512	PO512	5-1/4" x 12-1/2"	1 lbs	18.99
	SCR-714	PO714	7-1/8" x 14-1/2"	1 lbs	21.99

**BECKSON REPLACEMENT PORT GASKETS** Color: Black

Item	Model	Fits	Ship	Net
901789	GK-410	4" x 10"	1 lbs	\$9.99
	GK-414	4" x 14"	1 lbs	9.99
	GK-512	5" x 12"	1 lbs	9.99
	GK-714	7" x 14"	1 lbs	12.99

**ZARCOR CLOZURES BECKSON PORT LIGHT SHADE**

- Functions by simply moving one layer on top the second layer
- The shutters offer 100% UV protection
- Will make your boat's interior 15° cooler on a hot sunny day
- As opposed to curtains, sunlight will filter through the shutters
- When closed at night the shutters provide 100% privacy
- Easily removed for cleaning • All Ship 1 lbs

Please Specify: Seashell or White

Item	Model	Size	Beckson Port	Net
901762	P163-S	16-3/4" x 6-3/4"	414	\$29.99
	P107-S	14-5/8" x 7-3/4"	512	29.99
	P366-S	16-3/4" x 9-3/4"	714	39.99

**OCEANAIR PLEATED SHADE**

Helps keep you cool and ensures privacy and security onboard. Simple, flexible and easy to install in any boat interior, these fabric blinds are self-adjusting for height and non-parallel use.

Item	Color	Size	Ship	Net
900041	Cream or Navy	15" W x 12" H	1 lbs	\$71.00
901343	Cream or Navy	20" W x 12" H	1 lbs	83.00
901344	Cream or Navy	25" W x 12" H	1 lbs	89.00
900042	Cream or Navy	30" W x 12" H	1 lbs	Starting At 86.00
900043	Cream or Navy	40" W x 12" H	1 lbs	107.00

**OCEANAIR PORTSHADE**

Available in 5 standard sizes to fit most installations. Comes with all mounting hardware housed in a Silver anodized, White or Beige cassette and includes a tri-laminate black-out shade. Fabric shade is white. Please Specify: White, Beige or Silver housing Shade Size

Item	Model	(Width x Drop)	Ship
901510	PSH-1	13-3/8" x 11"	1 lbs
901511	PSH-2	15" x 11"	1 lbs
901512	PSH-3	18-1/8" x 12-5/8"	1 lbs
901513	PSH-4	26" x 12-5/8"	1 lbs
901514	PSH-5	28-3/8" x 12-5/8"	2 lbs





FOR BOMAR VOYAGER SERIES HATCHES PLEASE CALL OR VISIT WWW.DEFENDER.COM



**BOMAR**  
**BOYVE**

### Bomar Low Profile Extruded Hatch - Performance Series

This Bomar low profile hatch is an industry standard. Design features include quick-acting tie-down dogs and adjustable vent positions. Trim ring and screen below are available as options. The option of a shade screen and/or privacy shade is available on some models. Made of anodized aluminum.

Item	Model	Frame Size (OD of Lid)	Cutout	Cutout Radius	Ship	Net
900524	N1000-10P	13-7/16" x 13-7/16"	10-3/4" x 10-3/4"	1-11/16"	6 lbs	\$350.99
900523	N1011-10P	17-1/16" x 11-13/16"	9-1/8" x 14-3/8"	1-11/16"	7 lbs	408.99
900525	N1029-10P	21-3/16" x 16-1/16"	13-3/8" x 18-1/2"	1-11/16"	10 lbs	412.99
900528	N1039-10P	22-7/8" x 22-7/8"	20-3/16" x 20-3/16"	1-11/16"	14 lbs	488.99
900526	N1070-10P	19-1/4" x 19-1/4"	16-9/16" x 16-9/16"	1-11/16"	12 lbs	410.99
900527	N1080-10P	21-3/16" x 21-3/16"	18-1/2" x 18-1/2"	1-11/16"	14 lbs	441.99

Note: (P) indicates internal hinge A Series external hinge available at defender.com

#### TRIM RING AND SCREEN KITS FOR ABOVE

Trim Ring (Off-White).

Item	For Model	Ship	Net
900530	NT7000-OFF-W	1 lbs	\$46.99
900529	NT7011-OFF-W	2 lbs	46.99
901322	NT2029-OFF-W-I	1 lbs	66.99
900534	NT7039-OFF-W	2 lbs	54.99
900532	NT7070-OFF-W	1 lbs	46.99
900533	NT7080-OFF-W	1 lbs	54.99
900535	NT2049 Black	1 lbs	93.99

Screen Kit (Black)

Item	For Model	Ship	Net
900537	NS7000 BK	1 lbs	\$45.99
900536	NS7011 BK	1 lbs	45.99
900538	NS7029 BK	1 lbs	51.99
900541	NS7039 BK	1 lbs	58.99
900539	NS7070 BK	1 lbs	51.99
900540	NS7080 BK	1 lbs	58.99
900542	NS2049-EX	2 lbs	71.99

### Bomar Low Profile Traditional-Hatch Package

• Extra low-profile • Will not snag lines • Quick action dogs • Nylon bushing • Made of UV stabilized resin • Arms and dogs • Locking position • 1/2" air flow ventilation • Floated lens • Includes screen and trim • Available in Black or White.

Item	Color	Item	Color	Frame Size	Cutout	Cutout Radius	Ship	Net
900515	White	900516	Black	11-1/2" x 11-1/2"	9-1/2" x 9-1/2"	1-1/4"	5 lbs	\$219.99
900517	White	900518	Black	19-7/8" x 14-7/8"	17-7/8" x 12-7/8"	1-11/16"	8 lbs	279.99
900519	White	900520	Black	18-7/8" x 18-7/8"	16-7/8" x 16-7/8"	1-11/16"	10 lbs	311.99
900521	White	900522	Black	21-7/8" x 21-7/8"	19-3/4" x 19-3/4"	1-11/16"	12 lbs	391.99

### Vetus Altus SL Escape, Deck & Ventilation Hatch

Features a sturdy aluminum profile: only 13/16" high. Designed for ocean use and can be fitted on deck. This hatch is provided with carefully designed adjusters which are both stylish and easy to operate. The Altus hatches can be opened from inside or outside the boat and can be locked, either completely watertight or in a ventilation position. By means of a friction hinge, this hatch can remain open in any position without the need for adjustable supports.

• 10 mm acrylic • Color: "Dark Smoke" • Material: Anodized aluminum with satin finish

Item	Model	Type	Frame Size	Cutout	Ship	M.A.P.
901620	ALT2626SL	Ventilation	13-1/8" x 13-1/8"	10-1/4" x 10-1/4"	7 lbs	\$223.00
901621	ALT4242SL	Deck	19-1/2" x 19-1/2"	16-9/16" x 16-9/16"	13 lbs	344.63
901622	ALT4633SL	Deck	20-7/8" x 15-13/16"	18" x 12-7/8"	12 lbs	336.68
901623	ALT4747SL	Escape	21-7/16" x 21-7/16"	18-1/2" x 18-1/2"	14 lbs	377.23
901624	ALT5038SL	Deck	22-7/8" x 17-3/4"	19-15/16" x 14-13/16"	14 lbs	348.81
901625	ALT5151SL	Escape	23-1/16" x 23-1/16"	19-15/16" x 19-15/16"	17 lbs	401.48
901626	ALT6363SL	Escape	27-5/8" x 27-5/8"	24-11/16" x 24-11/16"	23 lbs	506.81
901627	ALTD420SL	Ventilation	19-5/16" x 12-13/16" (D-Shaped)	16-7/16" x 9-15/16" (D-shaped)	5 lbs	324.36
901628	ALTD520SL	Escape	23-5/16" x 20-5/8" (D-Shaped)	20-3/8" x 17-11/16" (D-shaped)	7 lbs	385.18
901629	ALTR420SL	Deck	19-3/8" Round	16-3/8" Round	13 lbs	324.36
901630	ALTR520SL	Escape	23-5/16" Round	20-3/8" Round	15 lbs	385.18

Please note: Imperial dimensions are approximate and the hatches are built to the metric spec which can be found on our website.

### Vetus Magnus SL Escape, Deck & Ventilation Hatch

An extra heavy duty hatch designed for ocean use which can be fitted in any part of the hull or deck. This hatch is provided with friction hinges which will keep it open in any position without the need for stays. The hatch can be opened through 180°, and there are virtually no obstructions in the hatch opening. Can be opened from inside or outside the boat and can also be left locked, either watertight or in a ventilation position.

• 10 mm acrylic • Color: "Dark Smoke" • Material: Anodized aluminum with satin finish

Item	Model	Type	Frame Size	Cutout	Ship	M.A.P.
901631	MAG2626SL	Ventilation	12-5/16" x 12-5/16"	10-1/4" x 10-1/4"	7 lbs	\$239.30
901632	MAG4242SL	Deck	18-11/16" x 18-11/16"	16-9/16" x 16-9/16"	13 lbs	385.18
901633	MAG4633SL	Deck	20-1/16" x 14-15/16"	18" x 12-7/8"	12 lbs	369.08
901634	MAG4747SL	Escape	20-9/16" x 20-9/16"	18-1/2" x 18-1/2"	17 lbs	450.17
901635	MAG5038SL	Deck	22" x 16-13/16"	19-15/16" x 14-13/16"	15 lbs	425.72
901636	MAG5151SL	Escape	22-3/16" x 22-3/16"	19-15/16" x 19-15/16"	19 lbs	466.27
901637	MAG6363SL	Escape	26-3/4" x 26-3/4"	24-11/16" x 24-11/16"	24 lbs	587.90

Please note: Imperial dimensions are approximate and the hatches are built to the metric spec which can be found on our website.

### Oceanair Surface SKYscreen for Bomar Hatch

The SKYscreen is a framed cassette with a UV treated roll-up screen on one side and a 100% blackout fabric on the other. Additional sizes are available as a special order. All dimensions are internal clearance. All ship 1 lbs. Available in Beige or White.

Item	Width	Length	Net	Item	Width	Length	Net
901369	10-3/4"	10-3/4"	\$202.00	901372	18-1/2"	18-1/2"	\$297.00
901371	16-1/2"	16-1/2"	269.00	901373	20-1/4"	20-1/4"	378.00
				901374	25-1/8"	25-1/8"	441.00

### Waterline Design Screens / Mosquito Nets

Waterline Mosquito Screens improved for 2019. Now 2 options to attach screens, original suction cups and new magnets. All screens fold up and fit in included storage bag.

#### HATCH INSECT SCREEN

Item	Model	Description	Ship	Net
901854	W1405	Small, Overall size 14" x 14", fits 12" x 12" openings	1 lbs	\$27.99
	W1410	Regular, Overall size 24" x 24", fits 20" x 20" openings	1 lbs	29.99
	W1415	Large, Overall size 31" x 31", fits 28" x 28" openings	1 lbs	31.99

#### PORTLIGHT INSECT SCREEN

Item	Model	Description	Ship	Net
901855	W1430	Small, Overall size 10" x 19", fits 7" x 17" openings, 2 to a Package!	1 lbs	31.99
	W1435	Large, Overall size 12" x 27", fits 7-3/4" x 25-1/2" openings each	1 lbs	29.99

#### COMPANIONWAY INSECT SCREEN

Item	Model	Description	Ship	Net
901853	W1460	Universal, Overall size 35" x 71", fits 33" x 69" openings.	4 lbs	86.99

❖ For more detailed product specifications and our complete selection visit [www.defender.com](http://www.defender.com) or call 800-628-8225. ❖



**Vetus**



**Oceanair**





**Lewmar Low Profile Hatches (Self Supporting Lid)**

The Low Profile hatches have a soft styling and a sleek look. They are ideal for use on power crafts. Smaller ventilation hatches are suitable for any deck location on sail boats; the larger hatches can be used as foredeck hatches on smaller to mid-size yachts. The acrylic color is Smoke Gray.

Item	Model	Size	Frame Size	Cutout Size	Cutout Radius	Ship	Net
901438	39910030	10	13" x 13"	10-1/4" x 10-1/4"	1-1/16"	6 lbs	\$226.99
901439	39920030	20	10-11/16" x 16-7/16"	7-15/16" x 13-11/16"	1-1/16"	7 lbs	233.99
901440	39930030	30	15-5/8" x 20-3/4"	12-7/8" x 18"	1-1/16"	11 lbs	336.99
901441	39940030	40	19-5/16" x 19-5/16"	16-9/16" x 16-9/16"	1-1/16"	12 lbs	356.99
901442	39944030	44	20-3/16" x 20-3/16"	17-3/8" x 17-3/8"	1-1/16"	13 lbs	372.99
901443	39950030	50	17-5/8" x 22-11/16"	14-13/16" x 19-15/16"	1-1/16"	13 lbs	384.99
901444	39960030	60	22-11/16" x 22-11/16"	19-15/16" x 19-15/16"	1-1/16"	19 lbs	429.99
901773	3608 Various	00-65	Lewmar Low Profile replacement hatch seal			Starting at \$38.99	



Low Profile Hatch

**Lewmar Medium Profile Hatches**

Completing Lewmar's extensive hatch range is the Medium Profile hatch. It has Lewmar's unique seal system, is CE approved and it has all the strength of the famous Ocean hatch. What's more, it fits the same cut-out sizes as the Ocean and Low Profile hatch. Like the Low Profile hatch, the Medium Profile has a user-replaceable acrylic lid. Should the lid be damaged, all it takes is a few hand tools and half an hour before the boat can set out to sea again. The acrylic color is Smoke Gray.

Item	Model	Size	Frame Size	Cutout Size	Cutout Radius	Ship	Net
901384	39930020	30	15-5/8" x 20-3/4"	12-7/8" x 18"	1-1/16"	14 lbs	\$389.99
901385	39940020	40	19-3/8" x 19-3/8"	16-9/16" x 16-9/16"	1-1/16"	15 lbs	395.99
901386	39944020	44	20-3/16" x 20-3/16"	17-3/8" x 17-3/8"	1-1/16"	17 lbs	417.99
901387	39950020	50	17-5/8" x 22-3/4"	14-13/16" x 19-15/16"	1-1/16"	16 lbs	441.99
901388	39954020	54	18-1/4" x 22-3/4"	15-7/16" x 19-15/16"	1-1/16"	17 lbs	457.99
901389	39960020	60	22-3/4" x 22-3/4"	19-15/16" x 19-15/16"	1-1/16"	20 lbs	474.99
901390	39970020	70	27-1/2" x 27-1/2"	24-11/16" x 24-11/16"	1-1/16"	26 lbs	661.99
901391	39977020	77	30-5/16" x 30-5/16"	27-1/2" x 27-1/2"	1-1/16"	33 lbs	1324.99
901806	Various	30-77	NEW! Lewmar Medium Profile replacement hatch seal			Starting at \$42.99	



Medium Profile Hatch

**Lewmar Ocean Hatches**

Lloyds' approved with patented lever/stay to hold latch open in any position up to 90° (sizes 10 to 20) or up to 180° (size 30 and up). Size 20 and under have 1 latch. Size 30 and up have 2 latches. Acrylic color is Smoke Gray. Hatches are available with flat base or with 1" flange. Interior hatch trim and insect screen kits are available options.

Item	Model	Size	Frame Size	Cutout Size	Cutout Radius	Ship	Net
900411	39610050	10 Flat	12-3/4" x 12-3/4"	10-1/16" x 10-1/16"	1-9/16"	7 lbs	\$336.99
900412	39610070	10 Flange	12-3/4" x 12-3/4"	10-1/4" x 10-1/4"	1-11/16"	7 lbs	338.99
900413	39620050	20 Flat	10-1/2" x 16-3/16"	7-3/4" x 13-7/16"	1-5/16"	8 lbs	340.99
900414	39620070	20 Flange	10-1/2" x 16-3/16"	7-15/16" x 13-11/16"	1-7/16"	8 lbs	342.99
900415	39630050	30 Flat	15-3/8" x 20-1/2"	12-11/16" x 17-13/16"	1-9/16"	12 lbs	465.99
900416	39630070	30 Flange	15-3/8" x 20-1/2"	12-7/8" x 18"	1-11/16"	13 lbs	466.99
900417	39640050	40 Flat	19-1/8" x 19-1/8"	16-3/8" x 16-3/8"	1-9/16"	13 lbs	504.99
900418	39640070	40 Flange	19-1/8" x 19-1/8"	16-9/16" x 16-9/16"	1-11/16"	13 lbs	508.99
901856	39644070	44 Flange	20-1/16" x 20-1/16"	17-3/8" x 17-3/8"	1-11/16"	14 lbs	585.99
901857	39644050	44 Flat	20-1/16" x 20-1/16"	17-3/16" x 17-3/16"	1-9/16"	14 lbs	605.99
900419	39650050	50 Flat	17-1/2" x 22-5/8"	14-5/8" x 19-3/4"	1-9/16"	17 lbs	565.99
900420	39650070	50 Flange	17-1/2" x 22-5/8"	14-13/16" x 19-15/16"	1-11/16"	17 lbs	578.99
900421	39660050	60 Flat	22-5/8" x 22-5/8"	19-3/4" x 19-3/4"	1-9/16"	21 lbs	631.99
900422	39660070	60 Flange	22-5/8" x 22-5/8"	19-15/16" x 19-15/16"	1-11/16"	22 lbs	633.99
900423	39665070	65 Flange	22-11/16" x 22-11/16" (26-9/16" max)	15-9/10" x 15-9/10" (20-6/10" max)	1-11/16"	24 lbs	666.99
900424	39670050	70 Flat	27-5/16" x 27-5/16"	24-1/2" x 24-1/2"	1-9/16"	25 lbs	841.99
900425	39670070	70 Flange	27-5/16" x 27-5/16"	24-11/16" x 24-11/16"	1-11/16"	29 lbs	845.99



Ocean Hatch

Ocean Series replacement hatch lids available at [www.defender.com](http://www.defender.com)

**Lewmar Hatch Trim and Insect Screen Kits**

Color: White. Includes screen and trim.

Item	Size	Description	Ship	Net	Item	Size	Description	Ship	Net	Item	Size	Description	Ship	Net
900426	00	Ocean	2 lbs	\$84.99	900436	40	All*	4 lbs	\$112.99	600961	44	All*	3 lbs	\$121.99
900762	00	Low Profile	1 lbs	85.99	900444	65	All*	4 lbs	148.99	900460	50	All*	3 lbs	126.99
900428	10	All*	3 lbs	87.99	900452	20	Ocean	2 lbs	92.99	900466	60	All*	4 lbs	133.99
900432	20	Low Profile	3 lbs	90.99	900454	30	All*	3 lbs	99.99	900472	70	All*	4 lbs	167.99

\*Fits all Lewmar hatches

**Lewmar Eclipse Roller Hatch Shade / Screen Combo**

Color: White. • 100% Blackout Material, UV Stable, Durable Flyscreen Mesh

• Excellent Resistance to Damp Conditions, Easy to Clean

Item 901840

Select Size 10-70

Starting At \$131.99



Eclipse

**Oceanair Cabinshade**

Cabinshade is a cassette roller blind housed in a simple, functional extrusion for hatches or windows. It can be used for vertical or horizontal surfaces with the added benefit of also being well suited for slightly curved headlinings.

- 100% blackout fabric
  - 100% marinated for the harshest environments
  - White shade
  - Simple installation
  - All mounting hardware included
- Please specify trim: Beige, White or Silver Trim

Item	Size	Dimensions	Ship	Starting at	Item	Size	Dimensions	Ship	Starting at
901503	1	14-1/8" W x 15-3/4" H	1 lbs	\$96.00	901507	3	21-5/8" W x 23-5/8" H	2 lbs	\$109.00
901505	2	18-1/2" W x 20-1/8" H	2 lbs	101.00	901509	4	26-3/4" W x 27-1/2" H	2 lbs	126.00



Cabinshade

**Oceanair Surface SKYscreen for Lewmar & Vetus Hatches**

The SKYscreen is framed cassette with a UV treated roll-up screen on one side and a 100% black-out fabric on the other. Additional sizes are available as a special order. All dimensions are internal clearance. Available in Beige or White. All ship at 1 lbs.

Item	Size	Width	Length	Net	Item	Size	Width	Length	Net
900390	10	10-1/4"	10-1/4"	\$195.00	900402	50	20"	14-7/8"	\$312.00
900393	20	13-5/8"	8"	195.00	901368	54	20"	15-3/8"	338.00
900396	30	18"	12-7/8"	221.00	900405	60	20"	20"	365.00
900399	40	16-5/8"	16-5/8"	260.00					
901367	44	17-3/8"	17-3/8"	286.00					

Liners available at [www.defender.com](http://www.defender.com)





**BOMAR ACCESS HATCHES**

Molded out of high impact UV stable polypropylene. Clean textured lid. Low profile for floor mounting. No screws visible from the exterior. 180° opening. Strong lid with support bars. Double gasket for optimum sealing. Easy opening, easy closing. Color: Stark White.

Item	Model	Latch	O.D. of Lid	Cutout	Cutout Radius	Ship	Net
901348	G7711-WT	Twist	14-1/16" L x 10-1/4" W	12-3/16" L x 8-3/16" W	1-15/16"	3 lbs	\$61.99
901349	G7812-WT	Twist	14-15/16" L x 12-15/16" W	13-1/16" L x 10-7/8" W	1-15/16"	4 lbs	65.99
901346	G71020-W	Twist	23" L x 14-3/16" W	12-1/8" L x 21-1/8" W	2-1/16"	7 lbs	89.99
901347	G71030-WT	Twist	30-1/4" L x 13-7/16" W	28-3/8" L x 11-3/8" W	2-1/16"	7 lbs	116.99



**IMTRA 4000 SERIES ACCESS HATCHES**

Made of durable UV-resistant ASA plastic. Cover opens 180° and lies flat to deck when open. Color: White.

Item	Model	Frame Size	Cutout	Opening Dimension	Ship	Net
900036	SPA-40105	11-1/8" x 14-3/4"	8" x 12"	7-1/2" x 11-1/2"	3 lbs	\$67.99
900037	SPA-40155	13-1/8" x 15-1/2"	10" x 12-3/4"	9-1/2" x 12-1/4"	3 lbs	74.99
900039	SPA-40205	13-7/8" x 23-1/4"	10-3/4" x 20-1/2"	10-1/4" x 20"	5 lbs	109.99



**BECKSON SCREW OUT DECK PLATES- All ship 1 lbs**

Item	Model	I.D.	O.D.	Cutout	Color	Net
900339	DP40-W	4"	6-1/8"	4-1/2"	White	\$15.99
900340	DP40-W-C	4"	6-1/8"	4-1/2"	White, Clear center	19.99
900341	DP40-B	4"	6-1/8"	4-1/2"	Black	15.99
900342	DP40-B-C	4"	6-1/8"	4-1/2"	Black, Clear center	19.99
900343	DP60-W	6"	8-1/8"	6-1/2"	White	21.99
900344	DP60-W-C	6"	8-1/8"	6-1/2"	White, Clear center	23.99

Item	Model	I.D.	O.D.	Cutout	Color	Net
900345	DP60-B	6"	8-1/8"	6-1/2"	Black	\$21.99
900346	DP60-B-C	6"	8-1/8"	6-1/2"	Black, Clear center	23.99
901035	DP80-W	7-5/8"	10"	8-1/2"	White	28.99
901036	DP80-W-C	7-5/8"	10"	8-1/2"	White, Clear center	34.99
901033	DP80-B	7-5/8"	10"	8-1/2"	Black	28.99
901034	DP80-B-C	7-5/8"	10"	8-1/2"	Black, Clear center	34.99



**BECKSON PRY OUT DECK PLATES- All ship 1 lbs**

Item	Model	I.D.	O.D.	Cutout	Color	Net
900347	DP61-W	6-3/16"	8-1/8"	6-1/2"	White	\$21.99
900348	DP61-B	6-3/16"	8-1/8"	6-1/2"	Black	21.99

Item	Model	I.D.	O.D.	Cutout	Color	Net
900349	DP83-W	8"	10"	8-1/2"	White	\$32.99
900350	DP83-B	8"	10"	8-1/2"	Black	34.99

**Hatch Accessories**

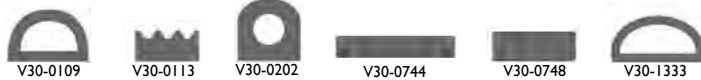

**TACO HATCH SEAL TAPE**

• Black, heavy duty self-adhesive backing • Seals, prevents leaks and reduces rattling

Item	Model	Size L x H x W	Ship	Net
900986	V30-0109	10' x 3/8" x 5/8"	1 lbs	\$18.99
900987	V30-0113	10' x 3/16" x 3/8"	1 lbs	18.99
900988	V30-0202	10' x 1/2" x 1/2"	1 lbs	23.99
900989	V30-0744	8' x 1/8" x 3/4"	1 lbs	13.99
900990	V30-0748	8' x 1/4" x 3/4"	1 lbs	13.99
900991	V30-1333	10' x 1/4" x 3/8"	1 lbs	21.99

**WEFCO SQUARE HOLLOW RUBBER GASKET Ship 1 lbs/ft**

• EPDM; sold per foot  
• Specify size: 1/4" x 1/4", 5/16 x 5/16", 3/8" x 3/8"  
Item 901171 For hatches, portlights, etc.  
The maximum continuous length we normally order is 100'. **Starting at \$1.69 ft**

**TAYLOR MADE ADJUSTABLE SIDE VENT HANDLE**

Designed to replace most original handles on side vent windows. Easy installation. Designed to fit side windows having exactly 1/4" mounting holes. (Sold in pairs - left and right)

Item	Model	Ship	Net
900351	11616	1 lbs	\$19.99

**WHITECAP SKYLIGHT HATCHHOOK**

Chrome-plated brass. Works on 3/8" threaded rod.

Item	Model	Size	Ship	Net
900647	S-041	3-3/4" x 1-5/8"	1 lbs	\$17.99

**MOONLITE HATCH LATCH**

The knob is designed to allow easy finger access and is rigidly mounted. The stop, mounted on the hatch frame, is small and rounded to minimize snagging.

Item	Model	Size	Ship	Net
900648	0100-1	3/8" - 7/8"	1 lbs	\$14.99
900649	0100-2	7/8" - 1-3/8"	1 lbs	15.99

**MOONLITE AUTOMATIC HATCH HOLDER**

Great for holding hatches, doors, table leaves, lids, etc. Automatically "pops" into place after unlatching. Stainless steel.

Item	Model	Size	Dim.	Mount	Hold Power	Ship	Net
900653	0045	Sm.	7/16"D x 8-1/2"L	L bracket	10 lbs	1 lbs	\$8.99
900654	0314	Med.	9/16"D x 10"L	Flat plate	45 lbs	1 lbs	12.99
900655	0115	Lg.	7/8"D x 11-3/4"L	Flat plate	100 lbs	1 lbs	45.99

**LEWMAR HATCH PARTS**

Item	Description	Ship	Net
900673	Hatch handle replacement kit for Ocean, low and medium profile series hatches	1 lbs	\$57.99
900741	Telescopic hatch stay for low profile and medium profile hatches	2 lbs	53.99
900561	Hatch catch block spare; Gray (includes rivets and washers)	1 lbs	22.99
900470	Retrofit hatch lock and key kit; fits any Lewmar hatch	1 lbs	109.99
900462	Retrofit flyscreen hinge kit; White; for Lewmar hatch flyscreen	1 lbs	23.99
601536	MK2 LP and MP alloy friction hinge	1 lbs	43.99

**WHITE WATER STANDARD DECK PLATE**

• Type: Screw out, Material: 316 stainless steel  
• Applications: Cowl vent

Item	Model	Diameter	O.D.	Ship	Net
901804	6361S	3"	4-5/8"	1 lbs	\$59.99
	6362S	4"	6-1/8"	1 lbs	64.99

**WHITE WATER WIRE DECK PLATE KEY**

• Applications: Most 3" and 4" deck plates  
• Material: Formed 304 stainless steel • Length: 7"

Item	Model	Description	Ship	Net
651069	1350KY	Wire deck plate key	1 lbs	\$4.99



**Hatch Accessories**

**PERKO SLIDING WINDOW PULL**

• 3" long and designed for 1/4" glass  
• This handle simplifies the operation of sliding windows  
• Stainless steel

Item	Model	Ship	Net
900469	0954DPOSTS	1 lbs	\$10.99

**WHITECAP WINDSHIELD KEEPER**

• Locks windshield in position and prevents rattling  
• Length: 1-5/8", width: 5/8" • Chrome-plated brass  
• Also used as a hatch fastener • Includes #8 fasteners

Item	Model	Ship	Net
900781	S-013	1 lbs	\$16.99

**VETUS REPLACEMENT SL HATCH HANDLE**

• Type: Locking • Sold as a pair  
• Applications: Vetus Altus SL and Magnus SL hatches

Item	Color	Ship	Net
901638	Black	2 lbs	\$29.99

**BOMAR HATCH DOGS All ship 1 lbs**

• Sold individually • Specify right or left hatch dog

Item	Description	Net
900514	For extruded hatches 2009 - Present	\$37.99
901141	For use with extruded hatches Pre - 2008	33.99

**BOMAR HATCH RISER ARM**

• Riser arm for Bomar cast 100 series cast hatch

Item	Model	Ship	Net
900775	P100-00	1 lbs	\$81.99

**BOMAR LATCH DOG ASSEMBLY**

• Tie down dog for Bomar 100 Series cast hatches

Item	Model	Ship	Net
901172	P100-09	1 lbs	\$34.99

**Knob only - Male, 5/16", Black**

Item	Ship	Net
901143	1 lbs	14.99

**ARMADA® PLASTIC WINDOW GUARDS**

• Simply snap on to a 1" rail • 6 to a pack  
• Stops burning, scratching and abrasion of plastic windows

Item	Description	Ship	Net
753341	White, plastic	1 lbs	\$7.49





**CAFRAMO MINIMAX FAN**

- Over 300 hours battery life
- Variable speed control
- Uses 4 "D" batteries (not included)
- 1 year warranty
- Folds flat
- **Specify color:** Black or White

Item	Dimensions	Ship	Net
900661	7" L x 5.4" W x 6" H	1 lbs	\$23.99

**CAFRAMO TAKU 7620 4-SPEED MARINE HATCH FAN**

- Power: 12 Volt DC
- Suction cup mount
- Draw: 0.2 A (Low) to 4.3 A (Turbo)
- Installs on most hatches 19" across and larger
- Color: White
- LED cabin light

Item	Dimensions	Ship	Net
900998	13.8" L x 11.5" W x 13.5" H	6 lbs	\$199.99

**CAFRAMO CHINOOK FAN**

- Silent, durable and safe
- Moves air 120 CFM (speed 1), 162 CFM (speed 2)
- 2 speed
- 2 year warranty

**Specify color:** Black or White

Item	Power	Dimensions	Ship	Net
900662	120 VAC	5.5" L x 7.5" W x 6" H	3 lbs	\$27.99

**CAFRAMO BORA FAN**

- Touch controls
- Locking position cam
- Commercial and recreational use
- 3 speed, 0.25 A @ 12 Volt DC
- High-output blade
- **Specify color:** Black or White

Item	Dimensions	VDC	Ship	Net
900015	6.5" W x 9.5" H x 3.5" D	12	2 lbs	\$69.99
	6.5" W x 9.5" H x 3.5" D	24	2 lbs	\$89.99

**ATTWOOD ULTIMATE 3-SPEED RECHARGEABLE FAN**

- 12-inch fan assembly, built-in high performance rechargeable battery pack, 12VDC power adapter plug assembly, 110 VAC/VDC adapter charger, removable support feet
- Soft-Start Battery Saver: 3 second delay in battery mode
- Airflow: Maximum 424 Cubic Feet per Minute (CFM)
- Battery charge time = 3.5 hours
- Low amp draw allows for extended battery life – over 7 hours run time on lowest setting
- 3-Speed
- Maximum amp draw = 1.1 amps
- 15" W x 16.94" H x 3.138" D

901175	Model 9040-4	White	Ship 4 lbs	Net \$64.99
--------	--------------	-------	------------	-------------

**MARINCO/GUEST 12 VOLT MINI SWIVEL PERSONAL FAN**

- Swivels to direct air flow
- Easily installed, vertically or horizontally; hardware included
- Low amperage

Item	Model	Description	Ship	Net
901037	903-5	White, 3" Base x 5"H	1 lbs	\$45.99



**CAFRAMO ULTIMATE CABIN FAN**

- 2 speed, 12 Volt DC, 0.40 A draw on high
- 6" cigarette lighter adapter cord
- Includes screw and suction cup base
- 150-200 CFM air flow
- Optional clamp for positioning
- 5" L x 2.3" W x 5.5" H

Item	Model	Color	Ship	Net
900258	747DCWCS	White	2 lbs	\$54.99

**Direct Wire Permanent Mount** (doesn't include suction cup mount)

900996	757DC	Black or White	2 lbs	\$44.99
--------	-------	----------------	-------	---------

**Mounting Clip-On Clamp** (with screws)

901671	747CL	For 747/757 fans	1 lbs	\$14.99
--------	-------	------------------	-------	---------

**CAFRAMO SIROCCO II FAN**

- 3 speed, 0.34 A @ 12 Volt DC
- Base dimensions: 7" L x 3" W
- Built-in shut-off timer (3, 6, 9, 12 hrs)
- Foldaway gimbal mechanism directs its output in any direction
- 185 CFM
- 2 year warranty

Item	Dimensions	Specify Color	Ship	Net
901785	3.5" L x 9.5" W x 12" H	Black or White	3 lbs	\$104.99

**CAFRAMO MAESTRO MARINE FAN**

- Power: 12 Volt DC
- Includes LED light Red/White
- Variable speed, fixed base with adjustable tilting head
- Includes wired remote pendant control (Can be surface or flush mounted)
- 130 CFM

Item	Dimensions	Specify Color	Ship	Net
901754	3.8" L x 6.5" W x 9.5" H	Black or White	2 lbs	\$99.99

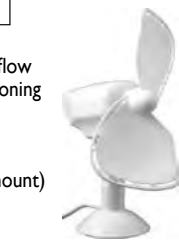

**HELLA 2-SPEED TURBO FAN**

- Turns/pivots in all directions
- Draw: 0.5 A @ 12 Volt DC, 0.25 A @ 24 Volt DC
- 5.5' cable to hardware
- 7.875" W x 7.125" H x 3.75" D
- 6.5 W max power usage

Item	Model	Color	Ship	Net
900682	003361002	12 VDC Black	2 lbs	\$74.99
	003361022	12 VDC White	2 lbs	74.99
	003361012	24 VDC Black	2 lbs	74.99



**MARINCO/GUEST CABIN FAN**

- Oscillates 120°
- 12 Volt DC motor draws 1.2 Amps
- White housing and 7-1/2" guard
- Mounts horizontally or vertically
- (3) Transparent blades
- 4.5" cable

Item	Model	Base dimensions	Ship	Net
900268	900	3.375" L x 1.5" W	3 lbs	\$93.99



**Hatch Accessories**

**SOGEMAN DELUXE HATCH UMBRELLA/TENT**

- Protects open hatch from rain and sun
- Installs in seconds and fits all hatches
- 100% Waterproof
- UV treated polyester
- Held in place by your halyard
- Size: 42" W x 42" L x 30" H

Item	Color	Ship	Net
900797	Off-White	2 lbs	\$91.99
900798	Royal Blue	2 lbs	91.99

**SOGEMAN BUGBUSTERS HATCH INSECT SCREENS**

- 100% polyester mesh
- Lead ballasted (will not affect compass)
- No attachments necessary
- Allows easy adjustment of hatch opening from inside
- Stows in a heavy duty plastic carry case
- Installs instantly

Item	Model	Size	Ship	Net
900959	Specify	15" x 15" or 12" x 18"	2 lbs	\$57.99

900162	ME1822	18" x 22"	3 lbs	62.99
900163	ME2525	25" x 25"	3 lbs	74.99
900164	ME3030	30" x 30"	4 lbs	83.99
901018	ME3636	36" x 36"	4 lbs	97.99

**SOGEMAN BUGBUSTERS COMPANIONWAY SCREEN**

- Ties to the handrail and drops to the cockpit floor
- No velcro or frame needed
- Allows full companionway opening, permitting very easy access to and from cockpit

Item	Model	Size	Ship	Net
900165	MD3672	36" W x 72" L	4 lbs	\$89.99
900166	MD4868	48" W x 68" L*	4 lbs	89.99

(\*extra wide size for use on Catalina, Caliber, Endeavor, etc.)

**Accessory Screen Snap Kit**

Item	Model	Contains	Ship	Net
900960	MDSNAP	(2) buckles with snaps and (2) screws	1 lbs	\$18.99

**BREEZE BOOSTER™ HATCH VENTILATOR**

- Collects the smallest breeze and directs it down the hatch
- Self-supporting
- Perfect for any powerboat or sailboat, monohull or catamaran
- Can be installed over your hatch in seconds
- Can be faced in any wind direction
- Easily closes to the size of a large umbrella
- Constructed of durable flag stock nylon and fiberglass bows

Item	Model	Size	Ship	Net
901718	Small	Hatch size up to 16"	2 lbs	\$60.99
	Medium	Hatch size 17-23"	3 lbs	72.99
	Large	Hatch size 22-28"	3 lbs	77.99

**BREEZE BOOSTER™ PORT VENTILATOR**

- An easy and efficient way to funnel air into side ports
- Perfect for boats which have inward opening ports
- Can be mounted on most vertical ports from inside the cabin
- Made of durable flag stock nylon and PVC Frame
- Fits inward opening ports with dimensions up to 10 x 17"

Item 901719	Please Specify: Blue, White or Navy	Ship 1 lbs	Net \$53.99
-------------	-------------------------------------	------------	-------------

**PLASTIMO HATCH SCOOP**

- Keeps the air flowing below deck or in the cabin no matter which way the wind is blowing
- Ultralight 100% polyester fabric
- Durable, reinforced seams
- Color: Yellow and White

Item	Model	Ship	Net
900776	37996	2 lbs	\$134.99

Note: 37996 is an omnidirectional hatch scoop

Item	Model	Ship	Net
900777	37995	3 lbs	\$84.99

Note: Includes Tensioning Fiberglass Batten

**THE ORIGINAL WINDSCOOP BY DAVIS**

- Lightweight scoop directs even the slightest breeze below deck
- Easily hung from halyard, boom or furling sheet on a sailboat or from any point higher up on a powerboat (nothing to install)
- Complete with nylon storage bag

Item	Model	Description	Ship	Net
900736	291	Colors vary	2 lbs	\$41.99



Strong Blue plastic case included with Hatch Tents



## Blowers



### JABSCO BLOWER

Heavy Duty units are rated for continuous duty and have a motor life of 5000 hours. Standard units are rated for intermittent duty and have a motor life of 1000 hours.

- Tough, reinforced plastic housing
- Slip-on inlet ducting connection
- Corrosion-resistant materials
- Mount to any surface
- Efficient, high volume airflow
- Low current draw



Flange



Flex

FLANGEMOUNT - Specify 3" (105 or 150 CFM) or 4" (250 CFM) diameter		
Item		Starting at
901817	Specify 12V or 24V	\$79.99
CONTINUOUS DUTY FLANGEMOUNT - 4" diameter, 250 CFM		
901821	Specify 12V or 24V	253.99
FLEXMOUNT - Specify 3" (105, 140 or 150 CFM) or 4" (250 CFM) diameter		
901819	Specify 12V or 24V	\$97.99
CONTINUOUS DUTY FLEXMOUNT - 4" diameter, 250 CFM		
901822	Specify 12V or 24V	259.99



### RULE IN-LINE BLOWERS

Provide ventilation for bilges, engine compartments, galleys and heads. Blowers are designed for efficient, high output operation. These blowers feature exclusive front and rear shaft seals and corrosion resistant motor housing which allows for longer life. They are compact and easily installed on any flat surface.



Item	Model	Size	Airflow	Voltage	Amps	Ship	Net
901816	140	3"	135 CFM	Specify 12 or 24	2.9	1 lbs	\$36.99
	240	4"	235 CFM	Specify 12 or 24	4.3	1 lbs	39.99



### SHURFLO YELLOWTAIL™ IN-LINE BLOWER

Designed to withstand the harsh marine environment, the YellowTAIL in-line blower comes standard with a fully protected heavy duty enclosed motor and tinned wire assembly. SHURflo has developed a unique nylon fan that includes 6 blades to ensure high performance and efficient ventilation. Installation of the YellowTAIL Blower is made easy with extended barbs and a slotted mounting bracket. 3 year warranty.



Item	Model	Size	Airflow	Voltage	Amps	Ship	Net
901823	277-3110	3"	120 CFM	12	3.7	2 lbs	\$29.99
	277-4110	4"	220 CFM	12	5.2	2 lbs	31.99

## Cowl, Hose & Clamshell Vents

### VETUS SILICONE COWL VENTS

Silicone rubber has many excellent mechanical qualities, but its greatest advantage is that it will not discolor in UV light. These new Vetus ventilators, made from silicone, will still look like new even after years in the Caribbean sun. The ring nut allows the ventilator to rotate or to be removed. It is easily loosened by hand and no tools are required. The new cowls can directly replace existing Vetus ventilators. 3 year manufacturer's warranty.



Item	Model	Height	Cutout Dia.	Ship	Net
901685	TRAMON	4-3/8"	2-15/16"	1 lbs	\$74.99
901686	LIBEC	8-1/16"	2-15/16"	1 lbs	76.99
901687	CHINOOK	9-13/16"	3-15/16"	2 lbs	82.99
901688	SAMOEN	11-13/16"	4-15/16"	3 lbs	119.99

Additional vent models, optional Dorade boxes, mosquito screens and mushroom vents are available at [www.defender.com](http://www.defender.com)

### VETUS STAINLESS STEEL COWL VENTS

Both the cowls and the rings are made of cast stainless steel. These cowls revolve and are removable. The clamping ring can be fastened by hand or with a special tool which is supplied as standard. If the tool is used for fastening, the risk of theft is almost eliminated. These cowls come complete with threaded ring nut and male deck ring. A mosquito screen and stainless steel cover plate can be supplied as an option.

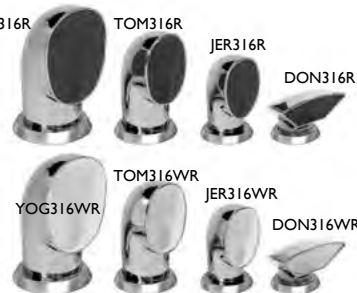

#### STAINLESS STEEL WITH RED INTERIOR

Item	Model	Height	Cutout Dia.	Ship	Net
900844	DON316R	4-3/4"	2-15/16"	4 lbs	\$324.99
900850	JER316R	8-1/16"	2-15/16"	5 lbs	324.99
900864	TOM316R	9-13/16"	3-15/16"	6 lbs	414.99
900875	YOG316R	11-13/16"	4-15/16"	8 lbs	554.99

#### STAINLESS STEEL WITH WHITE INTERIOR

900845	DON316WR	4-3/4"	2-15/16"	4 lbs	\$254.99
900851	JER316WR	8-1/16"	2-15/16"	5 lbs	324.99
900865	TOM316WR	9-13/16"	3-15/16"	6 lbs	414.99
900876	YOG316WR	11-13/16"	4-15/16"	8 lbs	554.99

## Cowl, Hose & Clamshell Vents

### MARINCO/NICRO PVC COWL VENTS

- White with Red interior
- Includes White snap-in deck plate and cover
- Sold individually

Item	Model	Vent Dia. x H	Description	Ship	Net
900197	N10963	3" x 8" H	Snap-in deluxe standard	2 lbs	\$61.99
900198	N10964	4" x 10" H	Snap-in deluxe standard	3 lbs	84.99
900194	N10863	3" x 4-1/2" H	Snap-in deluxe low profile	2 lbs	49.99
900195	N10864	4" x 5-1/2" H	Snap-in deluxe low profile	2 lbs	64.99

### MARINCO/NICRO ECONOMY CLAMSHELL

- Ideal for ventilation needs where a taller vent would foul lines or restrict crew movement
- Designed to cover a 4" to 5" diameter hose cutout
- Works well as a stern mounted engine vent or as a cabin ventilator

Item	Model	H x W x L	Ship	Net
900202	N10874	3" x 5-3/8" x 6-3/4"	1 lbs	\$21.99

### SEA-DOG VENTS WITH SNAP-IN DECK PLATE

Vents are durable and flexible dip molded White PVC with traditional Red interior. Cowl may be removed and replaced with flush deck plate closure in rough weather. Vents come complete with deck plate. Available in standard or low profile.

Item	Model	Description	Ship	Net
901468	727130-3	Low profile 3"D x 5"H	2 lbs	\$24.99
901469	727140-3	Low profile 4"D x 5-7/8"H	2 lbs	31.99
901470	727135-3	Standard 3"D x 7-3/4"H	2 lbs	31.99
901471	727145-3	Standard 4"D x 9-1/4"H	2 lbs	39.99

#### Deck Plates only

901315	727139	3" deck plate for cowl vent	1 lbs	5.49
901316	727149	4" deck plate for cowl vent	1 lbs	6.49

### SEA-DOG COWL VENT

Exterior color: White, Interior color: White

Item	Model	Vent Dia. x H	Ship	Net
900938	727132-3	Low profile 3" x 5"	2 lbs	\$26.99
900939	727142-3	Low profile 4" x 5-7/8"	2 lbs	32.99
900940	727137-3	Standard 3" x 7-3/4"	2 lbs	29.99
900941	727147-3	Standard 4" x 9-1/4"	2 lbs	39.99

### SEA-DOG STAINLESS STEEL CLAMSHELL MIDGET VENTILATOR

Item	Model	Length	Width	Height	Ship	Net
900243	331360-1	1-5/8"	1-3/4"	1/2"	1 lbs	\$2.29
900244	331370-1	2-1/4"	2-1/8"	5/8"	1 lbs	2.69

### SEA-DOG STAINLESS STEEL CLAMSHELL VENT

For use where a regular vent would be too bulky. Heavy duty.

Item	Model	Length	Width	Height	Ship	Net
900935	331340-1	7"	5-3/4"	2-1/4"	1 lbs	\$25.99
900936	331350-1	7-1/2"	6-3/4"	2-7/8"	1 lbs	28.99

### SEA-DOG ABS HOSE VENT

- Made of a high strength ABS plastic
- 3" vent measures 3-1/16" square
- 4" vent measures 4-15/16" square

Item	Color	Description	Ship	Net
900430	Black or White	3" Hose vent	1 lbs	\$3.89
900431	Black or White	4" Hose vent	1 lbs	4.49
900942	White	3" Flush vent	1 lbs	3.49
900242	Black	3" Flush vent	1 lbs	3.29
901353	Black	4" Flush vent	1 lbs	3.89

### SEATEAK DORADE BOX

- Waterproof venting system
- Size: 16" L x 7" W x 5-3/8" H

Item	900773	60310	Ship	5 lbs	Net	\$67.99
------	--------	-------	------	-------	-----	---------

### ATTWOOD HOSE FLANGE

- Black polyethylene hose flange
- Twist into 3" I.D. hose
- Moisture and gas resistant
- Mounts in 3-1/4" - 3-1/2"

Item	Model	Ship	Net
900171	1405-3	1 lbs	\$6.49

## Air Vent/Blower Hose

### BLUE TRIDENT POLYDUCT

Flexible, crush proof, rugged blower duct hose for heat, ventilation and A/C. Operating temperature -40 - 225°F. 3 year warranty.

Item	Model	Size	Net/Ft	Item	Model	Size	Net/Ft
901849	481-3000	3"	\$5.99	901849	481-4000	4"	\$7.99

### WHITE TRIDENT PVC VENT DUCT

Strong, flexible, wire-supported 3 mil vinyl. Resists weather, sunlight and ozone. Will not support a flame. Operating temperature 0 - 160°F. 1 year warranty.

Item	Model	Size	Net/Ft	Item	Model	Size	Net/Ft
901848	400-300	3"	\$1.29	901848	400-400	4"	\$1.69





## Sealing Strip & Tape/Window Channel



**SEAL STRIP GLASS SETTING RUBBER TAPE**  
Used to install edge channel 75-081; measures .025" x 1.5" x 100'.  
Item **900666** Model **75000662** Ship 3 lbs **Net \$30.99**



**STANPRO MARINE TRIM PLASTIC**  
Patented QuickEdge® basketweave pattern with steel core. Push on any exposed edge – metal, fiberglass, plastic, plywood, glass – and positive gripping power locks the trim in place. Sold per ft.

Item	Model	Thickness	Ship	Net/Ft.
000929	75000328	1/8" - 3/16"	1 lbs/10'	\$1.49
<b>STANPRO "Q" TRIM</b> Available in Black or White				
003421	75000343/4	3/16 - 1/4"	1 lbs/10'	\$2.29



**BOMAR LOW PROFILE HATCH GASKET**  
For Bomar low profile extruded hatches. 5/8"W X 5/8"H Sold per ft.  
Item **901500** Model **P2000-25** Ship 1 lbs/ft **Net \$7.99**



**BOMAR HATCH GASKET**  
9/16" wide. Sold per foot.  
Item **900063** Model **P100-52** Ship 1 lbs/ft **Net \$7.99**



**WFCO SQUARE HOLLOW RUBBER GASKET**  
• Ethylene propylene rubber; sold per foot  
• Applications: Portlights, hatches, door seal and more  
• Specify size: 1/4" x 1/4", 3/8" x 3/8", 5/16" x 5/16"  
Item **901171** Ship 1 lbs/ft  
The maximum continuous length we normally order is 100'. We may be able to special order longer lengths.

Starting at \$1.69 ft.



**LIFESAFE BUTYL CAULKING TAPE**  
Seals out dirt, dust, moisture and water. 3/4" x 1/8" x 20 ft.  
Item **755908** Specify Gray or White Ship 2 lbs **Net \$22.99**



**VINYL FOAM HATCH TAPE**  
• Seals out moisture, weather, sound and fumes  
• Pressure sensitive adhesive gives an excellent bond  
• Resists salt water and oxidation  
• Dimensions: 1/8" x 3/4" x 7' roll  
Item **755727** Model **RE3870** Ship 1 lbs **Net \$6.99**

**STANPRO STAINLESS STEEL SLIDING WINDOW CHANNELS**  
Made of Type 316 non-magnetic stainless steel. Glass slides on a heavy gauge plastic strip in the bottom of each channel over a felt cushion which permits installation screws to be countersunk without disturbing clearance. Polypropylene felt cushion will not rot or mildew. The channel is ultraviolet, moth and rust resistant.



**Single Rigid Channel**

Item	Type	Glass Thickness	Length	Ship	Net
<b>901846</b>	Single	7/32-1/4"	96"	2 lbs	\$41.29
<b>Double Rigid Channel</b>					
<b>901846</b>	Double	7/32-1/4"	96"	2 lbs	\$51.49



**EDGE CHANNELS**  
Seals the opening between two windows of 3/16" or 1/4" thickness. For installation, use seal strip glass setting tape on edge of panel.

Item	Model	Length	Ship	Net
<b>901847</b>	75000081	96"	2 lbs	\$46.99



**BECKSON CHANNEL MATE - 92" LENGTH**  
Available for single or double windows and doors. Made of "B" flex marine plastic that will not crack or discolor. Resistant to all weather, salt, spray and is non-corrosive. Features positive constant pressure that will resist leaks and prevent rattling. All ship 1 lbs.

**Color: White Please Specify: Single or double and glass thickness**

Item	Model	Type	Glass Thickness	Net
<b>901825</b>	<b>CH-1</b>	Single	1/4"	\$29.99
	<b>CH-2</b>	Double	1/4"	34.99
	<b>CH-4</b>	Single	3/16"	26.99
	<b>CH-3</b>	Double	3/16"	32.99

## Passive Vents



**MARINCO/NICRO AIRVENT 500/HIGH VOLUME PASSIVE EXHAUST VENT**  
• 7" across and 1-3/4" high • UV inhibited polycarbonate case  
• 3-3/4" cutout • 100% shutoff from below  
• 600-1000 CFH in a 15 knot breeze  
• Translucent center panel allows light below

Item	Model	Description	Ship	Net
901111	N28810	White ABS plastic	1 lbs	\$43.99



**BECKSON VENT-O-MATE**  
This draft-free, water-tight vent is powered by a slight breeze. Low 2-1/4" profile offers minimal wind resistance and reduces deck clutter. Even when vent is open, no rain can enter. Ideal for ventilating heads and galleys. Exhaust only. 350CFH in 6 knot breeze.

Item	Model	Cover	Cutout	Ship	Net
900188	C-6	7-3/4" dia., White plastic	4"	1 lbs	\$41.99
900189	C-6SS	7-3/4" dia., stainless steel	4"	2 lbs	72.99
900190	C-6R	Plastic replacement cover		1 lbs	18.99
900191	C-6RS	Stainless replacement cover		1 lbs	41.99

## Solar Vents



**MARINCO/NICRO DAY/NIGHT PLUS SOLAR VENT**  
• Moves up to 800 (3") or 1000 (4") cubic feet of air per hour  
• Easily retrofits to existing 3" or 4" Nicro openings  
• Removable from outside without tools  
• Built-in on/off fan switch, LED lights and intake/exhaust switch accessible from inside the cabin for ease of use

- Circulates fresh air in boat cabin eliminating mold, mildew and musty air
- Whisper quiet fan operation
- No wiring required
- Rechargeable battery allows for 24-hour continuous operation
- Complete air and green water shut-off from below
- Includes: White plastic interior trim ring, insect screen, mounting hardware, easy-to-understand installation manual

Item	Model	Cover Description	Vent Diameter	Ship	Net
901795	N20803W	White plastic	3"	5 lbs	\$159.99
	N20803S	Stainless steel	3"	5 lbs	168.99
	N20804W	White plastic	4"	5 lbs	164.99
	N20804S	Stainless steel	4"	5 lbs	172.99



### MARINCO/NICRO SOLAR EXHAUST MINI-VENT 1000

- 7" across and 1-3/4" high
- UV inhibitive polycarbonate case
- Moves up to 700 CFH on solar power
- 100% shutoff from below
- 3-3/4" cutout
- Solar powered exhaust ventilation during daylight and passive exhaust at night

Item	Model	Description	Ship	Net
900175	N20020	White ABS plastic	2 lbs	\$112.99

## Ventilators

### SEA-DOG LOUVERED STAINLESS STEEL VENTILATORS

Designed to promote air circulation in interior areas and prevent mold, mildew and unpleasant odors. Use on cabin doors, lockers, dock boxes, etc. Easy to install. Corrosion resistant. Vents A-F are stamped 304 stainless steel. Vent G is stamped 316 stainless steel.

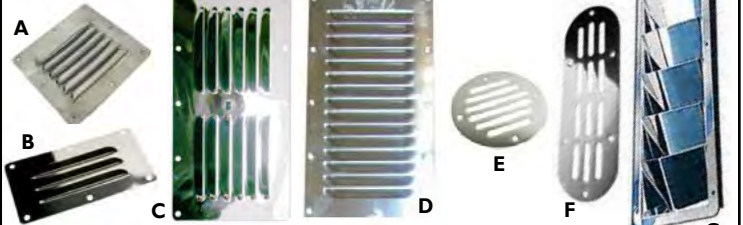

A	B	C	D	E	F	G
<b>A. For smaller areas that need ventilation</b>						
Item	Model	Size	Ship	Net		
900225	331390-1	5" x 4-5/8"	1 lbs	\$5.99		
<b>B. For locker doors and other small applications</b>						
Item	Model	Size	Ship	Net		
900226	331380-1	5" x 2-5/8"	1 lbs	4.69		
<b>C. For larger areas and those where mildew is a problem</b>						
Item	Model	Size	Ship	Net		
900227	331400-1	9-1/8" x 4-5/8"	1 lbs	10.99		
<b>D. For larger applications</b>						
Item	Model	Size	Ship	Net		
900228	331410-1	5" x 9"	1 lbs	10.99		
<b>E. Drain covers for dock boxes, lockers, etc. (flat)</b>						
Item	Model	Size	Ship	Net		
900229	331601-1	2-1/2" round	1 lbs	2.49		
900230	331600-1	3-1/4" round	1 lbs	3.49		
<b>F. Oblong locker ventilators; the oblong shape provides added ventilation (flat)</b>						
Item	Model	Size	Ship	Net		
900231	331620-1	6-3/4" x 2-3/8" oblong	1 lbs	5.49		
<b>G. Louvered ventilator</b>						
Item	Model	Size	Ship	Net		
900427	331290-3	4-1/2" x 12-7/8" rectangular	1 lbs	20.99		

**WHITECAP VENTS**  
• Will not rust, discolor or streak  
• Pre-drilled to accommodate screws  
All Ship 1 lbs.

**ZEBRA VENTS** Please specify Black or White nylon

Item	Dimensions	Cutout	Net
A. 900790	17-1/4" x 2-1/2"	15-7/8" x 2"	\$15.99

**LOUVERED VENTS** Please specify Black or White Nylon

Item	Dimensions	Cutout	Net
B. 900792	17-1/4" x 2-1/2"	16-13/16" x 2-5/16"	\$12.99
B. 900795	17-3/4" x 3-1/2"	15-7/8" x 2"	16.99
C. 900794	Black collector box for above		14.99

**SEA-DOG BUTTERFLY VENTILATOR 304 STAINLESS STEEL**

Item	Model	Diameter	Ship	Net
900233	331440-1	4"	1 lbs	\$7.49
900234	331450-1	5"	1 lbs	10.99

**SEA-DOG ABS LOUVERED VENTILATOR**  
Black plastic, 10-1/8" L x 4-7/8" H. 6 louvers.

Item	Model	Ship	Net
900232	337400-1	1 lbs	\$6.99

**SEA-DOG 316 STAINLESS STEEL NARROW SLOTTED VENTILATOR**  
8 louvers, 16-3/8" LOA x 2-7/8" WOA

Item	Model	Ship	Net
900249	331200	1 lbs	\$18.99



**Towable Rafts**



TOWABLES						
	Item	Description	Size	Riders/Style	Ship	Net
A.	950097	Airhead® Blast	54"	1/Donut	8 lbs	\$67.99
B.	450715	Airhead Big Shot®	76"	1-4/Donut	17 lbs	139.99
C.	950098	Airhead G-Force	64" x 60"	1-2/Deck	16 lbs	159.99
D.	950090	Airhead Hot Shot 2	57"	1/Deck	11 lbs	84.99
E.	950046	Airhead Slice	58"	1-2/Deck	13 lbs	114.99
F.	950047	Airhead Super Slice	70"	1-3/Deck	19 lbs	159.99
G.	950099	Airhead G-Force 3	78" x 75"	1-3/Deck	22 lbs	189.99
H.	950048	Airhead Viper 2	74" x 73"	2/Cockpit	28 lbs	239.99
I.	950058	Sportsstuff Big Mable	69" x 66"	1-2 Chariot	31 lbs	259.99



TOW ROPES, KWIK-CONNECTS & HARNESSES			
Item	Description	Ship	Net
450719	60' tow rope, 16 strand, 3/8", for 1-2 rider tubes	2 lbs	\$14.99
450718	60' tow rope, 16 strand, 9/16", for 3-4 rider tubes	3 lbs	19.99
950056	50' tow rope, 9/16", Airhead bungee style, 1-4 rider	4 lbs	35.99
450720	Kwik-Connect for towables, 1-4 rider, has a 1" hole to accept up to 6000 lb break strength tube ropes	1 lbs	8.99
450716	12' tow harness, for 1 rider tubes, Yellow/Red	1 lbs	10.99
450717	12' tow harness, heavy-duty, for 4 rider tubes, Yellow/Red	2 lbs	19.99



**Folding Bicycles and Accessories**

**DAHON**  
freedom unfolds



**MARINER D8 FOLDING BIKE**  
Its portability makes the Mariner D8 ideal for cruisers but also handy for those using multi-modal urban transportation.

- (8) speeds
- Lightweight Dalloy Sonus tubeset, lattice forged hinge with ViseGrip technology
- Forged alloy radius telescope w/ Fusion technology, adjustable
- Color: Silver
- Suggested rider height: 4'9" - 6'3"
- Maximum rider weight: 230 lbs

Item	Model	Ship	M.A.P
950182	92-4-04	48 lbs	\$625.00

**SPEED UNO FOLDING BIKE**  
One-speed design fits the lifestyle of urban commuters. At 26.25 pounds, the Speed Uno is one of Dahon's lightest bikes.

- DoubleLok design for maximum safety
- Magnetic latching system holds the folded bike neatly together
- Rear coaster brake requires pedaling backward to stop
- Color: Shadow
- Suggested rider height: 4'8" - 6'4"
- Maximum rider weight: 230 lbs.

Item	Model	Ship	Net
951646	92-1-41	60 lbs	\$399.99

**SPEED D7 FOLDING BIKE**  
Hand-welded and perfect for city riding.

- Fold in half or fold flat with FlatPak Technology
- Folds in under 15 seconds
- Flex-Adjust allows you to switch riding positions effortlessly
- Wheel diameter: 20"
- (7) speed rear derailleur
- Color: Black / Red
- Suggested rider height: 4'8" - 6'4"
- Maximum rider weight: 230 lbs.

Item	Model	Ship	Net
950117	92-1-07	57 lbs	\$529.99

**DAHON EL BOLSO FOLDING BIKE CARRY BAG**

- Suitable for all Dahon bikes
- Incredibly easy to use
- Black, IronGrid nylon
- Rolls up compactly into itself when not in use
- Made in the USA



Item	Model	Ship	Net
951575	13-1-00	3 lbs	\$109.99

**DAHON FOLDING BICYCLE STOW AND CARRY BAG**

- Rugged 1800D polyester, heavy duty zippers, robust seatbelt webbing, and 5 mm (0.2 ") of dense padding for protection
- Rolls up compactly when not in use
- Made in the US
- Please specify size



Item	Model	Size	Ship	Net
950064	13-3-02	16" - 20"	5 lbs	\$147.99
	13-3-03	24" - 26"	5 lbs	147.99

Visit [defender.com](http://defender.com) for a complete listing of Dahon bicycles



# Extend Your Boating Season with Webasto Marine Comfort Solutions

## Powerful, Compact & Quiet

Known as the quiet heater, Webasto air heaters offer high heat output in a compact design. Heating Power range from 3,000 BTU/h – 17,000 BTU/h.

Page 143



Air Heaters with SmarTemp Control 2.0



## Feel Cool Fast

Easy drop-in installation replacement for any brand self contained unit, high performing & quiet. Our wide power range provides cooling capacities from 6,000 BTU/h – 25,000 BTU/h.

Page 140



## KoolAir Pumps Boast Run Dry Protection to Keep You Cool

UL Listed, 1 year warranty, Graphite bushing on ceramic shaft, Certified Ignition Protected, Thermal Overload.

Page 140 & 141

[www.WebastoAC.com](http://www.WebastoAC.com)  
(844) WEBASTO



**A. RACE OCEAN JACKET**

• Durable waterproof and breathable 4-layer fabric • Low bulk hood features a 2-way adjustment system • Ocean height collar with wrap-around face guard • Gridded thermal inner collar and chin guard • Hand warmer pockets with YKK Aquaguard® water resistant zips and internal security pocket • Photoluminescent prismatic reflectives • Reflective Gill logos and 3M accents • 2-way zipper protected by a double front storm guard • Adjustable cuffs with PU inner seals • Cargo pockets • Hi-vis shock cord hem and waist adjustment • Alu D-ring attachment point

**Colors:** Blue/Graphite **Sizes:** M-XXL  

Item	Model	Ship	Net
154671	RS21	4 lbs	\$850.00

**B. RACE OCEAN TROUSERS**

• High fit design with SuperStretch back panel • Angled thigh cargo pocket • Inner thigh grip panel • Alu D-ring attachment point • Adjustable ankle closures • Adjustable shoulders • Heavy duty front zip with high internal gusset

**Colors:** Blue/Graphite **Sizes:** M-XXL  

Item	Model	Ship	Net
154672	RS22	3 lbs	\$599.00



**G. RACE FUSION JACKET**

• 3-layer waterproof and breathable fabric • Fully taped seams for a waterproof seal • Packable, 3-layer hi-vis hood with a 3-way volume adjustment • Quick dry brushed mesh collar lining • YKK Aquaguard® front zip • Pockets with anti corrosion YKK zippers • 3M accents provide 360° visibility • Adjustable outer cuff with PU inner seals • Hand warmer pockets • Adjustable hem • Longer back hem

**Colors:** Graphite or Tango **Sizes:** S-XXL  

Item	Model	Ship	Net
154668	RS23	2 lbs	\$349.00

**H. RACE FUSION TROUSERS**

• 3-layer waterproof and breathable fabric • Fully taped seams for a waterproof seal • High-fit design with SuperStretch comfort back panel • Reinforced seat and knees • Double ended YKK Aquaguard® front zip • Anti corrosion YKK zippers • Internal fly • Cargo thigh pocket with easy-access multi-tool pouch • Adjustable ankle closures and shoulders

**Colors:** Graphite **Sizes:** XS-XXL  

Item	Model	Ship	Net
154670	RS25	3 lbs	\$349.00



**NEW! MEN'S UV TEC CLOTHING**

A collection of lightweight, 50+ SPF sun protective sailing sportswear designed for warmer conditions. Cool and comfortable to wear with a performance pedigree. 50+ SPF

**M. LONG SLEEVE UV TEC TOP**

**Colors/Sizes:** Charcoal (S-XXL), Navy (S-XXXL) or White (XS-XXXL)

Item	Model	Ship	Net
154682	UV009 Zip neck	1 lbs	\$49.95
154685	UV011 No zip	1 lbs	39.95

**N. SHORT SLEEVE UV TEC TEE**

**Colors:** Charcoal (S-XXL), Med. Gray (XS-XXXL), Navy (S-XXXL) or White (S-XXXL)

154684	UV010	1 lbs	\$35.95
--------	-------	-------	---------

**O. UV TEC SHORTS & TROUSERS**

**Colors:** Graphite, Khaki, Navy or Silver **Sizes:** XS-XXXL

154687	UV012 Shorts	1 lbs	\$89.95
--------	--------------	-------	---------

154690	UV014 Trousers	1 lbs	120.00
--------	----------------	-------	--------

**C. OS1 JACKET**

• Offshore • Ocean Active  
 Fit hood design • Gridded thermal inner collar and chin guard • Ocean height collar with wrap-around face guard • Hand warmer pockets • Anti-corrosion YKK zippers • Heat-formed prismatic reflectives • Reflective Gill logos and accents for 360° visibility • 2-way zipper with double front storm guard • Adjustable cuffs with PU inner seals • Cargo pockets • Shock cord hem and waist adjustment • D-ring attachment point

**Colors:** Red or Graphite **Sizes:** S-XXL  

Item	Model	Ship	Net
154513	OS1J	4 lbs	\$599.00

**D. OS1 TROUSERS**

• High-fit with SuperStretch back panel and shoulder adjustment • Hand warmer pockets • Deep thigh pocket with D-ring attachment point • Anti-corrosion YKK zipper • 2-way zip with internal waterproof gusset • Reinforced seat and knees • Adjustable ankle closure • Secure multi-tool attachment point

**Colors:** Graphite **Sizes:** S-XXL  

Item	Model	Ship	Net
154514	OS1T	3 lbs	\$449.00



**I. COAST JACKET**

• 2 Dot fabric with fully taped seams for a waterproof seal • Roll away Hi-Vis hood and high collar with face guard • Adjustable cuffs with PU inner seals • Front zipper double storm guard • Fleece lined hand warmer and large capacity cargo pockets • High-visibility Reflexite® reflectives

**Colors:** Graphite, Bright Red or Dark Blue **Sizes:** XS-XXXL  

Item	Model	Ship	Net
154609	OS31J	3 lbs	\$229.00

**J. COAST TROUSERS**

• 2 Dot fabric with fully taped seams for a waterproof seal • Fully mesh lined with drainage facility • Front zip with internal gusset for wet weather protection • Adjustable suspenders for a comfort fit • Performance cut with articulated knees • Reinforced seat and knees and adjustable ankle closure

**Colors:** Graphite **Sizes:** XS-XXXL  

Item	Model	Ship	Net
154610	OS31T	3 lbs	\$159.00



**E. OS24J JACKET**

• 2-layer laminated waterproof, windproof and breathable fabric • High cut thermal collar • Thermal fleece inner collar and chin guard • Fully lined hi-vis hood with a 3-way adjustment • Adjustable outer cuff with PU inner seals • Hand warmer pockets protected by YKK water resistant zips • Internal security pocket • Deep cargo pockets with hand warmer pockets behind • 2-way zipper with double storm guard • Prismatic reflectives • Fully lined with mesh drainage panels • Adjustable shock cord hem

**Colors/Sizes:** Graphite (S-XXXL), Red (XS-XXXL), Tango (S-XXL) or Blue (S-XXL)  

Item	Model	Ship	Net
154674	OS24J	4 lbs	\$349.00

**F. OS24T TROUSERS**

• 2-layer laminated waterproof, windproof and breathable fabric • 2-way zip with internal waterproof gusset • Anti-corrosion YKK zip • Adjustable braces • Elasticated waist • Hand warmer pockets • Deep thigh pocket with D-ring attachment point • Performance cut with articulated knees • Abrasion resistant panels • Adjustable ankle closures

**Colors:** Graphite (S-XXXL), Blue (S-XXL) or Red (S-XXL)  

Item	Model	Ship	Net
154676	OS24T	3 lbs	\$235.00



**K. PILOT JACKET**

• Rollaway hood with 2-way volume adjustment • Adjustable cuffs lined with PU material • Front zipper with storm guard • Internal security pocket • Reflective detail • 2-layer laminated fabric with water repellent finish • Fully taped seams

**Jacket Color/Sizes:** Dark Blue (XS-XXL), Red (XS-XXL), Graphite (XS-XXXL)  
**Trousers Color/Sizes:** Graphite (XS-XXL)  

Item	Model	Description	Ship	Net
154613	IN81J	Jacket	2 lbs	\$179.00
154614	IN81T	Trouser	2 lbs	110.00

**L. PRO TOP**

• Close fitting PU neck seal • Adjustable neoprene waistband • Adjustable PU cuffs • PU Outer with 100% Polyester Fleece • 2-layer coated fabric with a durable repellent finish • Fully taped seams for a waterproof seal

**Colors/Sizes:** Red (XS-XXL), Bright Blue (XS-XXL), Black (XS-XXL)  

Item	Model	Ship	Net
154616	4310	2 lbs	\$130.00

**P. PRO RASH GUARD - LONG SLEEVE**

• 6 oz., 4-way stretch fabric for comfort and fit • 50+ UV protection • Flatlocked seams • 85% Polyester, 15% Elastane

**Colors/Sizes:** Bright Blue (XS-XXL), Red (XS-XXL), White (XS-XXL)  

Item	Model	Ship	Net
154620	4430	1 lbs	\$45.95

**Q. PRO DRYUIT**

• Internal adjustable elastic braces and elasticized waist • Durable Dynatex® waterproof zipper and taped seams • Ankle covers over the top of the latex seals • Pre marked collar and cuff seals • Reinforced knees and seat

**Colors:** Red  

Item	Model	Style/Size	Ship	Net
154228	4802	Men's, XXS-XXL	4 lbs	\$599.00

**Color:** Red  

154484	4803J	Junior's, JS - JL	4 lbs	525.00
--------	-------	-------------------	-------	--------



Gill Women's Clothing



**A. WOMEN'S OS12JW OCEAN JACKET**

• Durable, waterproof, breathable and fully-taped • Low bulk hood features a 3-way adjustment system • Ocean height collar with high, wrap-around face guard • Thermal inner collar and chin guard • Hand warmer pockets protected by YKK Aquaguard® water resistant zips • SOLAS grade reflectives • 2-way zipper with a double front storm guard • Abrasion resistant panels • Adjustable cuffs with PU inner seals • Cargo pockets • Shock cord hem and waist adjustment • D-ring attachment point

Color: Red

Item	Model	Sizes	Ship	Net
154515	OS12JW	8-14	4 lbs	\$599.00

**B. WOMEN'S OS12 OFFSHORE TROUSERS**

• Convenient drop-seat function • Hand warmer pockets • Deep thigh pocket with D-ring attachment point for marine tools or kill-cord leash • Anti-corrosion YKK zip with lightweight molded sliders • Double stormflap zipper protection with waterproof internal gusset • Abrasion resistant panels • External waist adjustment • Reinforced seat and knees • Adjustable ankle closure • Secure multitool attachment point

Color: Graphite

Item	Model	Sizes	Ship	Net
154516	OS12TW	8-14	3 lbs	\$449.00

**G. WOMEN'S PRO TOP & SALOPETTES**

• 2 dot, highly breathable and waterproof laminated fabric • Close fitting PU neck seal, zip closure and Velcro adjustment • Adjustable neoprene waistband and PU cuffs • Reflective accents for low light conditions • Zippered pocket positioned on the back for essentials • Female specific design and fit

Top colors: Aqua Salopettes color: Black

Item	Model	Sizes	Ship	Net
154617	4310W Pro Top	4-14	2 lbs	\$130.00
154619	4311W Salopettes	4-14	2 lbs	130.00



**C. WOMEN'S OS24JW OFFSHORE JACKET**

• Durable, waterproof, breathable and fully-taped • Laminated moisture-management fabric • Advanced composite waterproof fabric efficiently transports moisture away from the skin • High cut thermal collar with full face protection • Thermal fleece inner collar and chin guard • Fully lined hi-vis hood with a 3-way adjustment system • Adjustable outer cuff with PU inner seals • Deep cargo pockets with secure closure with hand warmer pockets behind • 2-way zipper protected by a double storm guard • Adjustable shock cord hem

Colors: Black/Graphite, Red/Bright Red or White/Blue

Item	Model	Sizes	Ship	Net
154675	OS24JW	6-16	3 lbs	\$349.00

**D. WOMEN'S OS24JT OFFSHORE TROUSERS**

• Laminated moisture-management fabric • Advanced composite waterproof fabric efficiently transports moisture away from the skin • Convenient drop-seat function • Double stormflap zipper with waterproof internal gusset • Anti-corrosion YKK zip • Adjustable braces • Deep thigh pocket with D-ring attachment point • Hand warmer pockets • Elasticated waist • Performance cut with articulated knees • Abrasion resistant panels • Adjustable ankle closure • Secure multitool attachment point

Color: Black/Graphite

Item	Model	Sizes	Ship	Net
154677	OS24TW	6-16	3 lbs	\$239.00



**H. WOMEN'S UV TEC LONG SLEEVE TEE**

• Ultra lightweight pique fabric • Actively wicks moisture away from the skin • 50+ UV protection • Flatlocked seams for comfort • 100% Polyester

Colors: Charcoal or White

Item	Model	Sizes	Ship	Net
154686	UV011W	4-14	1 lbs	\$39.95

**I. WOMEN'S UV TEC POLO**

• 50+ UV protection • Lightweight polyester technical fabric • Wicks moisture away from skin and dries quickly • 100% Polyester

Colors: Charcoal, Gray or White

Item	Model	Sizes	Ship	Net
154681	UV008W	4-14	1 lbs	\$45.95

**E. WOMEN'S COASTAL JACKET AND TROUSERS**

• Fully lined hi-vis hood with 2-way adjustment system • High cut thermal collar • Adjustable cuffs with PU inner seals • 2-way zipper protected by double storm guard • Deep cargo pockets with secure closure • 2-layer coated fabric with a water repellent finish • Fully taped seams for a waterproof seal

Jacket Color: Light Blue or Bright Red

Trouser Color: Graphite

Item	Model	Sizes	Ship	Net
154611	OS31JW Jacket	6-16	3 lbs	\$229.00
154612	OS31TW Trousers	6-16	3 lbs	159.00

**F. WOMEN'S PILOT JACKET**

• Rollaway hood with 2-way volume adjustment • Adjustable cuffs lined with a soft PU material • Front zipper protected by a double storm guard • Internal security pocket • Reflective detail • 2-layer laminated fabric with a water repellent finish • Fully taped seams for a waterproof seal

Colors: Berry, Graphite or Silver

Item	Model	Sizes	Ship	Net
154615	IN81JW	4-14	2 lbs	\$179.00



**J. WOMEN'S PRO RASH GUARD LONG SLEEVE**

• Material: 85% Polyester, 15% Elastane • 4-Way stretch fabric (6 oz) • UV 50+ protection • Flatlocked seams help to ensure comfort with effectively no irritation to the skin

Colors: Aqua or White

Item	Model	Sizes	Ship	Net
154621	4430W	4-14*	1 lbs	\$45.95

\*Sizes in Aqua are 6-14

Gill Footware

**GILL AQUATECH BOOT**

• 3 mm double lined neoprene • Wrap-around, non-marking rubber sole for improved grip • Blindstitched seams for waterproof seal • Adjustable strap for maximum support • Reinforced heel, toe and bridge area for increased support • 90% Neoprene, 10% Nylon

Sizes: 3/4, 5/6, 7, 7.5/8, 9, 10/10.5, 11/12, 13

Item	Color	Ship	Net
154626	Black/Red	2 lbs	\$49.95



**GILL AERO BOOT**

• Non-ferrous YKK zip • Wide supportive ankle strap for support • Blind-stitched seams for a waterproof seal • High grip sole • Reinforced heel, toe and bridge area for increased support • 90% Neoprene, 10% Nylon

Sizes: 3, 4, 5/6, 7, 7.5/8, 9, 10/10.5, 11/12, 13, 14

Item	Color	Ship	Net
154625	Black/Red	4 lbs	\$69.95



**GILL EDGE BOOT**

• 4 mm neoprene for warmth • Wrap-around, non-marking rubber sole for improved grip • Lace closure system • Wide supportive ankle strap • High grip sole • Blindstitched seams for a waterproof seal • Reinforced heel, toe and bridge area for increased support

Sizes: 3/4, 5/6, 7, 7.5/8, 9, 10/10.5, 11/12, 13, 14

Item	Color	Ship	Net
154624	Black	3 lbs	\$89.95



**GILL COMPETITION BOOT**

• 100% Natural rubber compound • Non-marking sole • Non-slip razor cut outsoles for grip • Quick drying polycotton lining • Waterproof construction • Close fitting, lace-up design for support and agility • Reinforced instep, toe and heel for support and durability • Supplied with stretch and static laces

Sizes: 5, 6, 7, 7.5, 8, 9, 10, 10.5, 11, 12, 13

Item	Color	Ship	Net
154480	Gray	4 lbs	\$99.95



**GILL SHORT CRUISING BOOT**

• 100% natural rubber compound • Mid-calf high with padded top • Non-slip, razor-cut soles with wave-cut grip • Removable cushioned inner soles • Quick drying polyester lining

Color: Carbon

Sizes: 5, 6, 7, 7.5, 8, 9, 10, 10.5, 11, 12, 13, 14

Item	Color	Ship	Net
154191	Carbon	5 lbs	\$69.95



**GILL TALL YACHTING BOOT**

• 100% natural rubber compound • Padded tie tops with soft rubber seals • Non-slip, razor-cut soles • Quick-drying polyester lining • Reinforced heel, instep and toe • Removable inner soles with arch support

Sizes: 4, 5, 6, 7, 7.5, 8, 9, 10, 10.5, 11, 12, 13, 14

Item	Color	Ship	Net
154192	Carbon	6 lbs	\$85.95



# Sperry Men's



## AUTHENTIC ORIGINAL All ship 3 lbs

- Hand-sewn Tru-Moc construction with shock absorbing EVA heel cup
- Non-marking, rubber sole with Wave-Siping™
- 360° Lacing System™ with rust proof eyelets

Item	Model	Color	Men's Sizes	M.A.P.
152893	0195115	Med. Brown	6-12, 13, 14, 15	\$95.00
152894	0195115	Wide Brown	7-12, 13	95.00
153319	0197640	Med. Sahara	6-12, 13, 14, 15	95.00
153320	0197640	Wide Sahara	7-12, 13	95.00
153218	0195214	Med. Amaretto and wide (wide width: 7-12, 13)	6-12, 13, 14	95.00
152969	0197632	Med. Oatmeal	6-12, 13, 14	95.00



Note: Brown and Oatmeal have White soles.



NEW COLOR!

## BILLFISH 3 EYE BOAT SHOE All ship 3 lbs

- Molded EVA cushion midsole
- Air-Mesh upper panels
- Shock absorbing EVA heel cup

Item	Model	Width	Color	Men's Size	M.A.P.
152900	0799023	Medium	Tan/Beige	7-12, 13, 14, 15	\$100.00
152901	0799023	Wide	Tan/Beige	8-12, 13	100.00
152898	0799320	Medium	Dark Tan	7-12, 13, 14, 15	100.00
152899	0799320	Wide	Dark Tan	8-12, 13	100.00
153784	1048826	Medium	Navy	7-12, 13	100.00
153785	1048826	Wide	Navy	8-12, 13	100.00



## SEAKITE SPORT MOC SNEAKER All ship 3 lbs

- Removable full-length EVA footbed
- Water-resistant leather and mesh uppers and linings
- Adaptive Wave-Siping disperses water underfoot

Item	Model	Color	Sizes	M.A.P.
153666	10528695	Med. Sudan Tan	7-12, 13	\$110.00
153654	10528703	Med. Gray	7-12, 13	110.00

# Sperry Women's



## AUTHENTIC ORIGINAL 2-EYE BOAT SHOES All ship 3 lbs

Whether you call them A/Os, boat shoes or Top-Siders, they will always be the Originals. Sperry's Authentic Original combines classic comfort and enduring style for a timeless look that works season after season, year after year.

- Traditional moccasin style boatshoe.
- Genuine Hand-Sewn Tru-Moc Construction
- Shock Absorbing EVA Heel Cup
- 360° Lacing System™ with Rust Proof Eyelets
- Non-Marking, Rubber Outsole with Razor Cut Wave-Siping™

Item	Model	Width	Color	Women's Size	M.A.P.
151795	9195017	Medium	Brown	5-11, 12	\$95.00
	9195017	Wide	Brown	5-11, 12	95.00
152921	9155240	Medium	Sahara	5-10, 11, 12	95.00
152922	9155240	Wide	Sahara	5-9, 10	95.00

## KOIFISH All ship 2 lbs

- Non-marking rubber outsole
- EVA molded midsole provides support and comfort
- Leather and textile upper
- Adjustable 360° lacing system ensures a secure fit

Item	Model	Width	Color	Sizes	M.A.P.
150842	STS95589	Medium	Linen/Oat	5-10, 11, 12	\$90.00



# Rugged Shark



## MERIDIAN BOAT SHOE

A premium, handsewn boat style with mesh upper accents and a built-in Aquire™ drainage system lets water out and air ventilation in. A cushioned footbed along with a compression molded EVA midsole provides all day comfort. Rugged Shark Bite™ Non-Marking rubber outsole gives great traction on wet decks.

- Heritage upper on new tech bottom
- Removable cushioned water friendly interior footbed
- Built for comfort - padded collar and a high-cushion compression molded EVA midsole
- Rugged Shark Bite™ slip-resistant non-marking rubber sole
- Aquire™ drainage construction

Color: Tan Item 154719 Sizes: 8-12, 13 Ship 3 lbs Net \$61.99



NEW!

## SPORTFISHER NEO

With a thin-cord bungee toggle closure and water friendly upper materials, the SPORTFISHER NEO provides the ultimate in water sport activities. Cushioned footbed and the Aquire™ drainage system lets water out and air in. Compression molded EVA midsole provides all day comfort and the Rugged Shark Bite™ Non-Marking rubber outsole gives great traction on wet surfaces.

- Quick drying upper materials
- Stretch Neoprene upper for excellent, bare-foot comfort
- Bungee closure provides snug-fit, but easy-on/easy-off
- Cushioned Insole for all-day comfort
- Rugged Shark Bite™ slip-resistant non-marking rubber sole

Color: Black Item 154720 Sizes: 8-12, 13 Ship 2 lbs Net \$71.99



NEW!

## GREAT WHITE BOOT

Vulcanized rubber waterproof construction guarantees long-lasting waterproof wear. The super-comfort PU cushioned footbed delivers all day comfort. The Rugged Shark Bite™ Non-Marking rubber outsole provides superior traction on wet surfaces.

- Removable Cushioned Water Friendly Interior Footbed
- Easy to put on and easy to take off
- Rugged Shark Bite™ Slip-Resistant Non-marking Rubber Sole
- Easy pull-on boot, with kick-off for safety

Color: Navy or White Item 154716 Ship 3 lbs Net \$61.99 Whole Sizes: 8-13

Color: Navy or Charcoal Item 154718 Ship 4 lbs Net \$71.99 Whole Sizes: 8-13

Color: Navy or White Item 154717 Ship 3 lbs Net \$71.99 Whole Sizes: 8-13



NEW!

# Gill



## MEN'S RACE TRAINER SNEAKER

- Non-marking and non-slip outsoles
- Quick-drain design
- Dual-density outsole with an EVA insert at the heel for extra impact protection
- 3D Spacer mesh uppers for extreme breathability and effective transfer of heat and moisture
- Air-cell impact absorbing and removable insole
- EVA insole with an anti-microbial treatment to reduce odor
- Molded multi-directional water dispersal channels and an 80% contact surface ensures that the grippy compound always stays in contact with the deck

Item	Model	Color	Sizes	Ship	Net
154532	RS11	Graphite Dark Blue	8, 9, 10-11, 12, 13	3 lbs	\$130.00
			8, 9, 10-11, 12, 13	3 lbs	130.00



New Dark Blue Color!

## MEN'S MAWGAN TRAINER

- Synthetic/Mesh upper
- Bungee laces
- Non-marking and slip resistant outsole
- Highly breathable
- Air-cell impact absorbing insole that is removable
- Dual-density outsole
- Low profile tread pattern with water expulsion channels for use in wet weather
- Heat molded toe and heel protection

Item	Model	Color	Sizes	Ship	Net
154700	936	Navy Blue	7-8, 9, 10-11, 12, 13	3 lbs	\$99.95



NEW!



## Gill Gloves

All gloves ship 1 lbs.

### KNIT FLEECE GLOVES

- Densely knit fleece gloves help protect hands
- Protective palm overlay allows you to get involved in normal activities
- Conductive fingertip and thumb mean you can use your devices without taking them off
- Comfortable fit and stylish design make the gloves perfect for use everywhere, and on any adventure



**NEW!**

Color: Graphite

Sizes: Adult, XS-XL

Item	Model	Net
154703	1495	\$30.00

### DECKHAND GLOVES

- 4-way stretch fabric across the back of the hand
- Double layer Amara® reinforcement
- Pre-shaped construction
- Wraparound palm protection

Color: Gray

Sizes: Junior, XS-XXL

Item	Model	Type	Net
154535	7042	Short	\$26.95
154536	7052	Long	28.95



### CHAMPIONSHIP GLOVES

- 4-way stretch fabric across the back of the hand
- Pre-shaped construction
- Dura-Grip™ palm fabric

Color: Black

Sizes: XS-XXL

Women's Sizes: S, M or L

Item	Model	Type	Net
154537	7242	Short	\$34.95
154538	7252	Long	36.95
154539	7262	Women's Long	36.95



### THREE SEASON GLOVES

- Dura-Grip fabric on palm and each finger
- Pre-shaped construction
- Lightweight, neoprene construction
- Wraparound palm protection
- Race proven flexibility
- Extended cuff length

Sizes: Junior, XS-XXL

Item	Model	Color	Type	Net
154543	7775	Black	Short	\$35.95



### PRO GLOVES

- Next-generation Proton-Ultra XD palm and fingers
- Dura-Grip fabric on palm
- 2-way stretch fabric across the back of the hand
- Notched finger construction
- Wraparound palm protection
- Pre-shaped construction fits your natural hand shape
- Wide neoprene wristband with stretch

Sizes: XS-XXL

Item	Model	Color	Type	Net
154540	7442	Black	Short	\$44.95
154541	7452	Black	Long	46.95



### GRIP GLOVES

- Rubber coated palm – breathable back
- Outstanding grip in both wet and dry conditions

Sizes: S-XL

Item	Model	Color	Net
154037	7600	Carbon	\$8.99



### NEOPRENE WINTER GLOVES

- 3 mm double-lined neoprene
- Liquid taped seams protect
- Smoothskin wrist seal
- Durable sharkskin palm
- Water resistant

Sizes: Junior, XS-XXL

Item	Model	Color	Net
154485	7672	Black/Gray	\$55.95



### GILL HELMSMAN GLOVES

- Waterproof and breathable
- Exceptional warmth and durability
- Pre-curved fingers
- Elasticized cuff and drawcord closure
- Extended gauntlet length

Sizes: XS-XXL

Item	Model	Color	Net
154544	7804	Black/Gray	\$55.00



## NEW! Gill Socks

All socks ship 1 lbs.

### KNIT FLEECE SOCKS

- Waterproof, windproof, breathable
- Durable nylon outer shell
- Thermal inner sock with moisture wicking capability
- Thin enough to be worn inside boots and performance footwear
- High performance breathable membrane reduces build-up of perspiration

Color: Dark / Light Gray / Red

Item	Model	Net
154702	762	\$40.00



### TRAINER SOCKS

- Lightweight mesh upper panel for maximum breathability
- Elasticized arch support
- Cushioned heel, ball and toe
- Smooth toe seam for comfort
- Technology: Coolmax fibers wick away moisture keeping your feet dry and comfortable
- Merino wool provides comfort, moisture management and odor control
- Fabric Composition: 24% Polyester Coolmax®, 18% Wool Merino, 18% Acrylic, 2% Elastane

Color: Black or White, Pack of (2) Pairs

Item	Model	Net
154373	758	\$29.95



### TRAINER SOCKS

- Lightweight mesh upper panel for maximum breathability
- Elasticized arch support
- Cushioned heel, ball and toe
- Smooth toe seam for comfort
- Coolmax fibers wick away moisture keeping your feet dry and comfortable
- Merino Wool provides comfort, moisture management and odor control
- Fabric Composition: 24% Polyester Coolmax, 18% Wool Merino, 18% Acrylic, 2% Elastane

Color: Gray

Item	Model	Net
154374	759	\$19.95



### BOOT SOCKS

- Boot height, wool rich thermal sock
- Elasticized arch and ankle support
- Cushioned construction throughout
- Smooth toe seam for comfort
- Technology: Merino Wool provides comfort, moisture management and odor control

Color: Gray

Item	Model	Net
154375	761	\$25.95



## NEW! Gill Hats

All hats ship 1 lbs.

### TECHNICAL UV SUN HAT

- Wicking inner headband
- Stiffened and non-absorbent brim
- Volume adjustment
- Removable chin strap and adjustment
- 50+ UV protection
- Lightweight water resistant fabric
- 100% Nylon

Color: Silver, Navy or Khaki

Item	Model	Ship	Net
154704	140	1 lbs	\$29.95



### RACE CAP

- 100% Nylon
- Wicking inner headband
- 50+ UV protection
- Lightweight and water resistant
- Includes retainer cord with clip

Color: Silver, Blue or Graphite

Item	Model	Ship	Net
154529	RS13	1 lbs	\$25.95



### REGATTA VISOR

- Helps prevent you from overheating and keeps the sun out of your eyes
- Built-in UV 50
- Retainer cord has an anti-corrosion clip
- Includes reflective detailing
- Wicking headband for hot weather comfort
- Lightweight breathable fabric
- 100% Nylon

Item	Model	Ship	Net
154623	145	1 lbs	\$20.00



## NEW! Gill Sunglasses

All glasses ship 1 lbs.



RACE FUSION Colors: Blue/Blue or Tango/Orange  
Item 154705 Model RS26 Net \$125.00



RACE OCEAN SUNGLASSES Colors: Black/Orange  
Item 154706 Model RS27 Net \$125.00



RACE VISION BI-FOCAL Colors: Black/Smoke 1.50, Black/Smoke 2.50, Woodgrain/Amber 1.50, Woodgrain/Amber 2.50  
Item 154715 Model RS28 Net \$99.95



MARKER Colors: Black/Smoke, Blue/Smoke  
Item 154709 Model 9674 Net \$70.00



CLASSIC POLARIZED Colors: Black, Black/Blue, Matte Black, Matte Gray, Navy, Red, Silver or Tortoise Shell  
Item 153044 Model 9473 Net \$89.95



GLARE Colors: Black or Tortoise Shell  
Item 154710 Model 9658 Net \$89.95



COASTAL Colors: Ash/Smoke, Black/Smoke or Tortoise/Amber  
Item 154711 Model 9670 Net \$75.00



NEWLYN Colors: Black  
Item 154712 Model 9672 Net \$65.00

### REGATTA CAP

- Built-in UV 50
- Headband wicks moisture away from the skin
- Hidden adjustment system
- Retainer cord with corrosion-proof clip
- Reflective detail for visibility
- Lightweight breathable fabric
- 100% nylon

Item	Model	Ship	Net
154622	146	1 lbs	\$25.00



### i3 MICRO FLEECE BEANIE HAT

- Protects from the elements with snug shape and soft micro fleece
- Anti-pill finish
- 4-way stretch ensures it perfectly covers the head
- Use under a hood when you need extra protection

Item	Model	Ship	Net
150226	HT11	1 lbs	\$25.95



### SAILING CAP

- Comfortable sailing cap made from premium weight, brushed cotton
- Practical design with no top button
- Non-corrosive rear metal adjuster
- 6 Panel construction

Item	Model	Ship	Net
154239	139	1 lbs	\$19.95



**Bags**



**NEW!**

**GILL DRY CYLINDER BAG**

- Puncture resistant waterproof fabric with stitch-free welded construction
- Roll-down closure for a watertight seal with side-release fastening
- Flat base improves stability meaning the bag can be stacked in tight upright spaces
- Semi-transparent, mesh-reinforced window so you can see what's inside

Item	Model	Capacity	Ship	Net
154497	L055	5 liter	1 lbs	\$25.95
	L054	10 liter	1 lbs	35.95
	L053	25 liter	3 lbs	45.95
	L056	50 liter	5 lbs	69.95



**NEW!**

**GILL RS14 TEAM RACE BAG**

- 60 liter capacity
- Velcro fastening and a roll-down closure for a watertight seal
- Reinforced haul-handles at both ends
- (4) External D-ring attachment points
- Waterproof ID pocket
- Non-slip, padded shoulder strap
- Puncture resistant waterproof 100% PVC tarpaulin fabric
- Stitch-free, high frequency welded seams
- Dimensions: 31" L x 13" H x 15" W

Item	Model	Color	Ship	Net
154533	RS14	Blue	3 lbs	\$79.95
	RS14	Graphite	3 lbs	79.95
	RS14	Tango	3 lbs	79.95

**Watches**



**RONSTAN CLEAR START SAILING WATCH**

- Multiple Start Sequence options
- SYNChronisation function • Stainless Steel housing and band
- Multi-line display - Start Sequences + Time
- Loud intuitive count down and start sound signals
- Water resistant to 5 ATM (50m/150ft) - double gasket seals
- Ultra-clear, durable sapphire coated mineral crystal lens
- Face diameter: 2" • Digit display: oversized 1/2"

Item	Model	Ship	Net
153334	RF4053	1 lbs	\$99.95



**RONSTAN CLEAR START SAILING WATCH**

- Multiple Start Sequence options
- SYNChronisation function
- Multi-line display - Start Sequences + Time
- Loud intuitive count down and start sound signals
- Face diameter: 2" • Digit display: oversized 1/2"
- Ultra-clear, durable sapphire coated mineral crystal lens
- All Stainless Steel body • Double stitched canvas wrist band

Item	Model	Ship	Net
153335	RF4053A	1 lbs	\$119.95



**RONSTAN CLEAR START RACE TIMER**

- Multiple Start Sequence options • Rotating Face
- SYNChronisation function
- Multi-line display - Start Sequences + Time
- Loud intuitive count down and start sound signals
- Water resistant to 5 ATM (50m/150ft) - double gasket seals
- Mounting Options: Wrist, Hull, Mast and Boom
- Face Diameter: 2-9/16" • Digital Display: Oversized 5/8"

Item	Model	Ship	Net
153228	RF4050	1 lbs	\$99.95

**Sunbrella Colors (see page 176)**



Other colors available on request and at [www.defender.com](http://www.defender.com)



Some manufacturers set M.A.P. (Minimum Advertised Pricing) for their products, so we cannot advertise a lower price. However, this does not always apply to selling price. The actual price you will be charged is probably lower. Please call us at 800-628-8225 for further details.



**NEW!**

**RACE TEAM BAG 30L**

- 30 liter capacity
- Designed with welded seams and a roll-down closure, the bag becomes watertight
- External attachments are available to secure bag
- (4) External D-ring attachment points
- Secure fastening and a roll-down closure for a watertight seal
- Non-slip, padded shoulder strap
- Puncture resistant waterproof PVC tarpaulin fabric
- Stitch-free, high frequency welded seams

Item	Model	Color	Ship	Net
154627	RS19	Blue	3 lbs	\$59.95
	RS19	Graphite	3 lbs	59.95
	RS19	Tango	3 lbs	59.95



**NEW!**

**RACE TEAM BACKPACK**

- 35 Liter capacity
- Padded and breathable, this backpack offers a comfortable fit
- Large volume front pocket with water resistant zipper
- Roll down closure for waterproof seal
- Padded and breathable airmesh harness system
- Puncture resistant waterproof PVC Tarpaulin fabric
- Stitch-free, high frequency welded seams
- Dimensions: 22" L x 25" H x 7" D

Item	Model	Color	Ship	Net
154714	RS20	Graphite	3 lbs	\$99.95
	RS20	Tango	3 lbs	99.95



**NEW!**

**RONSTAN CLEAR START SAILING WATCH**

- Lens is ultra-clear, scratch resistant, mineral crystal
- Recessed case is glass-reinforced polycarbonate with stainless steel structural tension ring around the hardened crystal lens
- Band is injection molded in a soft-feel silicon and can be removed and replaced if necessary • Buttons act on precision stainless push rods sealed with triple gaskets in stainless tubes to prevent moisture entry • Face diameter: 2" • Digit display: oversized 1/2"

Item	Model	Ship	Net
153337	RF4055	1 lbs	\$94.95



**NEW!**

**GILL W013 RACE WATCH**

- Carbon reinforced ABS plastic construction with a stainless steel case back • Flexible, hard wearing TPU strap
- Water resistant to 30 m • Countdown timer with synchro • Key lock function • Shock and impact resistant construction • Electro luminescent backlight with increased luminosity and a hi-vis start button • Time, date and day • Alarm function • Clear Audible alarm and alert sounds

Item	Model	Ship	Net
154349	W013	1 lbs	\$110.00



**GILL REGATTA RACE TIMER WATCH**

- Full dot matrix display • 1" digit height
- Time display • Alarm clock function
- Chronograph – 50 lap memory, Recall Lap Time and Total Time
- Countdown timer – 10, 5, 3, 2, 1 minute presets or user defined
- Time synchronization • Repeat countdown function
- Sleep mode • Water resistant to 50 m
- Easy battery change – simple twist opening

Item	Model	Ship	Net
154391	W014	1 lbs	\$110.00

**Nautolex Colors (see page 175)**

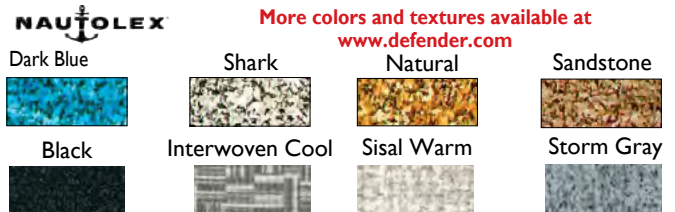

**Treadmaster Colors (see page 175)**





Onyx Inflatable Life Jackets

**M-24 IN-SIGHT MANUAL INFLATABLE LIFE JACKET**

- **USCG TYPE III**
- Clear viewing window that shows GREEN if the product is properly armed
- Minimum buoyancy: 22.5 lbs when inflated

Size: Universal fits adults over 80 lbs

Item	Color	Ship	Net
Ⓞ 550488	Blue/Gray	2 lbs	\$109.99

**A-24 IN-SIGHT AUTOMATIC INFLATABLE LIFE JACKET**

- **USCG TYPE III**
- Dual adjustments with "webbing locks" to manage excess webbing
- Secure pull – clips to life jacket; allows for quick release when pulled for inflation
- Extended sizing fits up to a 65" chest
- Protective cover uses 400 denier nylon ripstop and nylon oxford
- 1.5" buckle and body belt

Size: Universal fits adults over 80 lbs

Color: Gray or Aqua

Item	Ship	Starting at
Ⓞ 551364	2 lbs	\$119.99

**M-16 MANUAL INFLATABLE BELT PACK**

- **USCG TYPE III**
- Extremely low profile
- 1" buckle and body belt
- 200 denier nylon oxford protective cover
- 16 gram CO2 charge provides 17 lbs. of buoyancy
- Oral inflation tube provides additional buoyancy up to 26.5 lbs.

Size: Universal fits adults over 80 lbs

Item	Color	Ship	Net
Ⓞ 551401	Gray or Aqua	2 lbs	\$59.99

**M-24 MANUAL INFLATABLE LIFE JACKET**

- **USCG TYPE V WITH TYPE III PERFORMANCE**
- Inflates by manual or oral inflation
- 200 Denier nylon ripstop fabric
- Minimum buoyancy: 22.5 lbs

Size: Universal fits adults over 80 lbs

Item	Color	Ship	Net
Ⓞ 550490	Red	2 lbs	\$99.99

**A/M-24 AUTOMATIC/MANUAL INFLATABLE LIFE JACKET**

- **USCG TYPE V**
- With Type III performance • Soft neoprene neckline
- Convertible from automatic/manual to manual only
- Durable 200 denier ripstop/fabric resists tears and punctures

Size: Universal fits adults over 80 lbs

Color: Blue/Black, Pink or Green

Item	Ship	Starting at
Ⓞ 551016	2 lbs	\$98.99

PLEASE VISIT [WWW.DEFENDER.COM](http://WWW.DEFENDER.COM) FOR REARM KITS

**Full Throttle® Vests**

- Dries quicker and is lighter weight than neoprene
- No VOCs (Volatile Organic Compounds)
- Stretchable rapid-dry fabric

**INFANT, CHILD AND YOUTH RAPID-DRY VESTS II & III**

- **Infant** – Pop-up pillow, leg and grab strap (less than 30 lbs) - Type II
- **Child** – Leg and grab strap (30-50 lbs children) - Type III
- **Youth** – 50-90 lbs youth - Type III
- **Teen** – Offers greater mobility for active teens - Type III

Item	Model	Color	Ship	Net
552545	Infant	Blue	1 lbs	\$28.99
552546	Infant	Pink	1 lbs	28.99
552544	Child	Blue	1 lbs	28.99
552540	Teen	Blue	1 lbs	28.99

**INFANT/CHILD CHARACTER VEST • TYPE II**

- Bright, colorful graphics for added visibility
- Zippered front with waist belt and leg strap
- Pop-up pillow provides added head support
- Convenient grab strap for quick recovery

Size: Infant/Child less than 50 lbs

Item	Color	Ship	Net
550578	Fish	1 lbs	\$17.99
550399	Orange	1 lbs	17.99
550528	Mermaid	1 lbs	17.99

**CHILD CHARACTER VEST • TYPE III**

- Colorful graphics for added visibility • Adjustable belts, chest strap, and leg strap

552547	Pixie	Size: Child 30-50 lbs	Ship 1 lbs	Net \$18.99
--------	-------	-----------------------	------------	-------------



**Onyx IMPULSE A-33 IN-SIGHT AUTOMATIC INFLATABLE LIFE JACKET WITH HARNESS • USCG TYPE II**

- Front zipper closure for a low profile, secure fit
- Sailing harness with soft harness loops and lay-flat design
- Dual adjustments with "webbing locks" to manage excess webbing
- Secure pull – clips to life jacket; for quick release when pulled
- Quickburst® zipper opens upon inflation; easy to repack
- Inflation chamber has SOLAS reflective material and light attachment
- 1.5" buckle and body belt • Marine whistle included
- Protective cover uses 400 denier nylon oxford and 500 denier Cordura®
- Type V performance

Size: Universal fits adults over 80 lbs, Fits up to 65" chest

Item	Color	Ship	Net
Ⓞ 551363	Gray	6 lbs	\$227.99

**IMPULSE A-24 IN-SIGHT INFLATABLE PFD / LIFE JACKET • USCG TYPE III**

- Protective cover uses durable 400 denier nylon oxford and 500 denier Cordura®
- V-back for comfort and faster donning
- 1.5" buckle and with a "webbing lock" to manage excess webbing
- Quickburst® zipper opens upon inflation
- Dual adjustments for a snug fit • Fits up to a 65" chest
- Air mesh in contact areas • Hanging loop for drying

Size: Universal fits adults up to 65" chest

Item	Color	Ship	Net
Ⓞ 552583	Blue	3 lbs	\$176.99

**Onyx All Adventure Vests**

**MOVEMENT CURVE PFD • TYPE III**

- Soft, lightweight flotation foam • 200 denier nylon outer shell
- Provides excellent mobility for recreational paddle sports
- Ventilation in front and back to keep you cool
- Sculpted and flexible design conforms to your body
- Shoulder adjustments with neoprene comfort pads
- Adjustable side belts • Strong, durable zipper closure

Sizes: XS/S, M/L, XL/XXL

Please Specify Color: Blue or Yellow

Item	Ship	Net
552572	2 lbs	\$38.99

**ALL ADVENTURE PFD • TYPE III**

- Lightweight, durable flotation foam
- Bright colored shoulders for increased visibility
- Seven segmented hinge points
- Durable nylon outer shell
- Zippered front with waist belts and covered leg strap

Size: Child, 30-50 lbs

Please Specify Color: Orange or Pink

Item	Ship	Net
550576	1 lbs	\$24.99

Size: Youth, 50-90 lbs

Please Specify Color: Green or Aqua

Item	Ship	Net
550577	1 lbs	\$24.99



**CHILD WATER BUDDIES VEST • TYPE III**

- Unique shaped foam back that brings the Water Buddies to life
- Friendly, imaginative characters that will be with your child on the water
- Zippered front with waist belts and leg strap to keep vest from riding up
- Lightweight, durable flotation foam

Size: Fits 30-50 lbs children

Item	Model	Ship	Net
552584	104300-105-001-17 Princess	1 lbs	\$19.99
552585	104300-500-001-17 Turtle	1 lbs	19.99
550579	104300-200-001-15 Dinosaur	1 lbs	19.99

**ADULT DUAL SIZED RAPID-DRY WATER SPORTS VEST • TYPE III**

- Poly-span liner material provide increased stretchability and better fit
- (3) adjustable belts to keep vest from riding up
- Dual-sized for a more universal fit

Please Specify Size: S/M, L/XL, 2XL/4X

Item	Color	Ship	Net
552538	Blue	2 lbs	\$37.99
552539	Aqua	2 lbs	37.99





**KHIMERA™ 22 HYBRID PFD**

This vest changes the rules of the game by elevating performance both in and out of the water. It has enough foam flotation to provide neutral buoyancy and a back-up manually activated inflation cell.

- **USCG APPROVED LEVEL 70 BUOYANCY AID**
- Dual flotation system blends the security of foam flotation with the slim profile of inflatable technology
- 7.5 lbs foam buoyancy keeps you afloat without creating bulk
- Pulling the manual inflator boosts you to 20.5 lbs of buoyancy
- Lightweight and low profile design offers greater comfort and range of motion and eases re-entry into your boat from the water
- Adjustable shoulder straps for an improved fit

**Size:** Universal adult, 30-52" chest **Specify color:** Azure Blue, Red, or Admiral Gray

Item	Model	Description	Ship	Net
Ⓞ 552704	MD7183	Automatic vest	2 lbs	\$199.99
Ⓞ 552705	MA7116	Re-arm kit	1 lbs	19.99

**ELITE™ 28 INFLATABLE PFD**

**Hydrostatic Inflator Technology**

- **USCG TYPE III RECREATIONAL**
- **USCG TYPE V COMMERCIAL**
- Aerodynamic 3D chassis reduces drag at high speed
- Wicking mesh liner improves breathability
- Shaped for optimum mobility and all day comfort
- Automatically inflates when immersed in 4"+ of water
- Sleek inflation handle prevents unnecessary interference or snags
- Bright fluorescent Yellow-Green inflation cell for improved in-water visibility
- 28 lbs (125 N) buoyancy when inflated (1.5 times that of standard foam PFDs)

**Size:** Universal adult, 30-52" chest **Specify color:** Gray or Black

Item	Model	Description	Ship	Net
Ⓞ 550594	MD5183	Automatic vest	3 lbs	\$239.99
Ⓞ 550595	MA5183	Re-arm kit	1 lbs	59.99



**HIT™ INFLATABLE PFD HYDROSTATIC INFLATOR TECHNOLOGY**

- **USCG TYPE II (MD3183 02) & USCG TYPE V COMMERCIAL**
  - Bright fluorescent Yellow-green inflation cell with SOLAS reflective tape, safety whistle and strobe light attachment
  - Provides 38 lbs (150 N) buoyancy when inflated
  - Lightweight outer shell fabric – used in the body armor industry – with reflective accents
  - Zippered pocket for your phone, keys or license
  - Neoprene Comfort Collar™ improves comfort and durability
- Size:** Universal adult, 30-52" chest

**HIT™ INFLATABLE PFD WITHOUT HARNESS**

**Color:** Gray/Black, Red/Black or Black

Item	Model	Description	Ship	Net
Ⓞ 550592	MD3183 02	Vest without harness	3 lbs	\$249.99

**HIT™ INFLATABLE PFD WITHOUT HARNESS**

**Color:** Black or Red/Black

Item	Model	Description	Ship	Net
Ⓞ 550593	MD3184 02	Vest with harness	3 lbs	259.99

**RE-ARM KIT FOR MD3183, 3184 AND 3188**

Item	Model	Description	Ship	Net
Ⓞ 552292	MA7214	Re-arm kit	1 lbs	61.99

**DLX INFLATABLE PFD**

- New compact no-bayonet inflator
- Discreet anodized side-pull inflation handle
- AIS compatible to aid searchers in a rescue situation
- Zippered side pocket
- More comfortable fit around neck and back
- MOLLE inspired attachment system for custom configuration of gear (Pocket sold separately)
- Dual side adjusters provide an easy size adjustment
- 38 lbs buoyancy when inflated

**Size:** Universal adult, 30-52" chest  
**Color:** Black/Fluorescent Yellow Green, Gray/Fluorescent Yellow Green, Red/Black

Item	Model	Description	Ship	Net
Ⓞ 552579	MD2983	Automatic vest, USCG Type II	3 lbs	\$151.99
Ⓞ 552580	MD2981	Manual vest, USCG Type III	3 lbs	136.99



**MANUAL INFLATABLE POUCH • USCG TYPE III**

- Inflates by pulling cord or oral inflation as secondary option
- Provides 35 lbs buoyancy when inflated and fully donned

**Color:** Black/Carbon **Size:** Universal Adult, 80 lbs +

Item	Model	Description	Ship	Net
Ⓞ 552398	MD3075	Inflatable pouch	2 lbs	\$87.99
Ⓞ 552600	MA7114	Re-arm kit	1 lbs	25.99



**M.I.T. 100 INFLATABLE PFD**

- **USCG TYPE III RECREATIONAL • USCG TYPE V COMMERCIAL**

- 500 Denier CORDURA® outer shell
- Membrane Inflatable Technology lightweight inflation cell
- Inflator inspection window and easy access flap
- 1-fold, easy to repack design
- Provides 28 lbs (100 N) buoyancy when inflated
- More than 1.5 times the buoyancy of most foam PFDs

**Size:** Universal adult, 30-52" chest  
**Specify color:** Black/Fluorescent Yellow-Green, Gray/Fluorescent Yellow-Green or Black/Red

Item	Model	Description	Ship	Net
Ⓞ 550590	MD2014 02	Manual vest	2 lbs	\$109.99
Ⓞ 550591	MD2016 02	Automatic vest	2 lbs	129.99
Ⓞ 552432	MA2014	Re-arm kit	1 lbs	29.99



**M.I.T. 100 INFLATABLE PFD**

- **USCG TYPE III RECREATIONAL**
- 500 Denier CORDURA outer shell
- Membrane Inflatable Technology™ lightweight inflation cell with reflective tape and safety whistle
- Inflator inspection window and easy access flap
- 1-fold, easy to repack design
- Provides 28 lbs (100 N) buoyancy when inflated
- More than 1.5 times the buoyancy of most foam PFDs

**Size:** Universal adult, 30-52" chest **Color:** Orange/Black

Item	Model	Description	Ship	Net
Ⓞ 550596	MD2016 T1	Automatic vest	3 lbs	\$129.99
Ⓞ 552432	MA2014	Re-arm kit	1 lbs	29.99



**DELUXE ANTI-EXPOSURE COVERALL & WORKSUIT**

- Type V (Approved only when worn)
  - Flotation and hypothermia protection
  - Inflatable head support pillow for added buoyancy
  - Neoprene wrist closures and Tug-Tites® at thighs and ankles
  - Ergonomic insulated hood easily folds into collar
  - SOLAS reflective tape for improved visibility
  - Chest, front cargo pockets and thigh pockets
- Sizes: XS – XXXL

Item	Model	Color	Ship	Net
551832	MS2175	Orange/Black or Solid Orange	6 lbs	\$427.99

**COLD WATER IMMERSION SUIT**

- USCG approved
- Inflatable head pillow
- Five-fingered insulated gloves
- Lifting harness
- Wrist and ankle adjustments
- Water-tight face seal
- 5 mm fire retardant neoprene
- Face shield protects against spray
- Non-slip, durable soles on foot bottom
- Triple-sealed seam construction
- SOLAS tape and hailing whistle

**Size:** Adult universal **Body weight:** 110 - 330 lbs  
**Height:** Max. 75"

Item	Model	Color	Ship	Net
552529	MIS230 HR	Red	12 lbs	\$329.99





**YOUNG ADULT VEST • USCG TYPE III**

- Specially designed interior foam panels form-fit the body for a better fit compared to a small adult vest
- MOLLE inspired accessory panel for custom attachment of gear
- Cooling-channeled interior back
- Segmented foam panels for an active, flexible fit

Colors: Gray/Light Gray/Fluorescent Yellow-Green or Gray/White/Pink

Item	Model	Description	Ship	Net
552578	MV3300	70-125 lbs	2 lbs	\$69.99



**LIL' LEGENDS**

This feature-laden children's PFD offers all the bells and whistles to keep your wee one safe, including head pillows, crotch strap (no crotch strap on Youth model), and grab handle.

**Features:**

- Ultra soft
- Stain resistant
- Ventilated mesh back
- Wicking liner
- Note that infant model is USCG Approves and not Harmonized

Model MV325002 USCG Approved (not Harmonized)

Models MV3555 & MV3560 Harmonized Level 70 Buoyancy (equivalent to TYPE III)



Item	Model	Description	Size	Colors	Ship	M.A.P.
552746	MV325002	Infant PFD	20-30 lbs	Red or Blue	1 lbs	\$59.99
552747	MV3555	Child PFD	33-55 lbs	Red or Blue	2 lbs	\$9.99
552748	MV3560	Youth PFD	55-88 lbs	Red or Blue	2 lbs	\$9.99

**REV CHILD/YOUTH VEST**

An excellent all-around PFD for older children who no longer need head pillow support (or stubbornly refuse it). Ultra soft fabric resists stains and segmented foam flexes to keep kids moving.

**Features:**

- Ultra soft
- Stain resistant
- Segmented foam for enhanced mobility
- Ventilated mesh back
- Wicking liner
- Harmonized Level 70 Buoyancy (equivalent to TYPE III)



Item	Model	Description	Size	Colors	Ship	M.A.P.
552744	MV3565	Child PFD	33-55 lbs	Red or Blue	1 lbs	\$49.99
552745	MV3570	Youth PFD	55-88 lbs	Red or Blue	1 lbs	\$9.99

**LIKE US ON FACEBOOK**  
[WWW.FACEBOOK.COM/DEFENDERINDUSTRIES](http://WWW.FACEBOOK.COM/DEFENDERINDUSTRIES)

**Gloves**

**TRACTION UV GLOVE**

- UPF 50 Protection • Finger pull tabs with silicon grip
- Lightweight polyester Spandex knit with UV treated yarns
- AX Suede™ G-series palm overlays
- Cuff pull tab with silicon grip • Pairing snaps

Color: Light Gray/Blue

Item	Model	Sizes	Ship	Net
154504	MA6007	S-XL	1 lbs	\$24.99



**TRACTION OPEN FINGER GLOVE**

- Finger pull tabs with silicon grip ease doffing
- Lightweight polyester Spandex knit with UV treated yarns
- Knuckle overlays offer added protection
- AX Suede™ G-series palm overlays
- UPF 50 protection
- Pairing snaps

Item	Model	Sizes	Ship	Net
154502	MA6002 02	S-XL	1 lbs	\$28.99



**TRACTION FULL FINGER GLOVE**

- Fold back thumb, index and middle finger
- Back of hands are 2.5 mm neoprene
- AX Suede™ G-series palm overlays
- Knuckle overlays offer added protection
- Pairing snaps

Item	Model	Sizes	Ship	Net
154503	MA6003 02	S-XL	1 lbs	\$32.99



**MUSTANG 4-ONE • USCG TYPE I**

- Approved USCG SOLAS, TC SOLAS, MED SOLAS and USCG Type I
- Offshore life vest with buddy line • SOLAS whistle included
- Color: International Orange • Solas grade reflective tape
- Keeps most unconscious wearers face-up in the water

Item	Model	Size	Ship	Net
552435	MV8040	Adults over 90 lbs	2 lbs	\$63.99
552436	MV8035	Children 33 to 95 lbs	2 lbs	\$6.99



**T1 UNIVERSAL FIT FLOTATION VEST • USCG TYPE III**

- Functional industrial flotation with large arm holes
- SOLAS reflective tape on the shoulders

Sizes: Adult universal for chest sizes from 30" - 52"; 80 lbs or over

Item	Model	Description	Ship	Net
550204	MV3104 T1	Orange	2 lbs	\$36.99



**INDUSTRIAL MESH VEST • USCG TYPE III PFD**

- SOLAS reflective tape on front and back
- Mesh shoulders for mobility and comfort
- (2) Large front pockets with Velcro™ closure

Sizes: S/M, L/XL, 2XL/3XL, 4XL/5XL\*

Item	Model	Description	Ship	Net
552328	MV1254 T1	Orange	2 lbs	\$56.99
550588	MV1254 T3	ANSI Yellow Green	2 lbs	\$9.99



\* 4XL/5XL available for model # MV1254T1

**4 POCKET FLOTATION VEST • USCG TYPE III PFD**

- SOLAS approved tape and grommets
- Side adjustment straps
- (4) Velcro secured pockets
- (4) D-rings provided for lanyard attachment

Specify size: S (32" - 36" chest), M (36" - 40" chest), L (40" - 44" chest), XL (44" - 48" chest), XXL (48" - 52" chest)

Item	Model	Description	Ship	Net
551869	MV3128 T2	Orange	2 lbs	\$49.99



**SEARCH & RESCUE PFD VEST • USCG TYPE III PFD**

- (2) Large front cargo pockets with easy to use pull tabs
- 62 sq. in. reflective tape
- Large cutaway armholes and neoprene-lined, fitted collar

Specify size: Small (34" - 38"), Medium (38" - 42"), Large (42" - 46"), X-Large (46" - 50"), XXL (50" - 54"), XXXL (54" - 58")

Item	Model	Description	Ship	Net
552320	MV5600	Orange	2 lbs	\$197.99



**CATALYST FLOTATION COAT, JACKET & BIB PANTS**

- USCG TYPE III
- M-Tech Comfort System™ provides better range of motion
- Waterproof, breathable, tri-laminate outer shell
- Field tested by Coast Guard training crews
- Interior, chest, front slash and hand-warmer pockets
- Underarm ventilation zippers • Reflective accents
- Integrated hood • D-ring

Sizes: S-XXXL

**Catalyst Flotation Coat**

Item	Model	Color	Ship	Net
550337	MC5444	Orange/Black or Red/Black,	5 lbs	\$299.99

**Catalyst Flotation Jacket**

Item	Model	Color	Ship	Net
550336	MJ5244	Black, Red/Black	6 lbs	\$299.99

**Catalyst Bib Pants**

Durable Cordura knee and seat reinforcements, fleece-lined hand-warmer pockets, adjustable suspenders and zippered legs.

Item	Model	Color	Ship	Net
552433	MP4240	Black	4 lbs	\$299.99



**Accessories**

**LEG STRAP**

Snaps to PFD waist belt to provide a more secure fit  
 Item 550462 Model MA3032 Ship 1 lbs Net \$49.99



**BELT EXTENDER** Color: Black

Item	Model	Size	Ship	Net
550235	MA7637	12" L x 1-1/2"W	1 lbs	\$18.99
552577	MA7632	12" L x 2"W	1 lbs	\$21.99



FOR ADDITIONAL VESTS AND RE-ARM KITS PLEASE VISIT [WWW.DEFENDER.COM](http://WWW.DEFENDER.COM)

**Onyx General Purpose Life Jackets**

**INFANT, CHILD, YOUTH GENERAL PURPOSE VESTS • USCG TYPE II & III**

- 200 denier nylon and 150 denier poly-twill
  - Adjustable belts • Lightweight, durable foam
- Please choose color: Red/Black or Blue/Black**
- Infant/Child Type II** – Pop-up pillow, leg strap, grab strap
- | Item   | Fits                     | Ship  | Net     |
|--------|--------------------------|-------|---------|
| 550421 | Infants less than 50 lbs | 1 lbs | \$17.99 |
- Child Type III** – Leg strap
- |        |                    |       |       |
|--------|--------------------|-------|-------|
| 550422 | Children 30-50 lbs | 1 lbs | 17.99 |
|--------|--------------------|-------|-------|
- Youth – Type III**
- |        |                 |       |       |
|--------|-----------------|-------|-------|
| 550423 | Youth 50-90 lbs | 1 lbs | 17.99 |
|--------|-----------------|-------|-------|



**ADULT GENERAL PURPOSE • USCG TYPE III**

- 200 denier nylon and 150 denier poly-twill
  - Adjustable belts for a secure fit
  - Lightweight, durable foam • Contours to your body
  - Open-sided styling • Large armholes
- Size: Please choose Universal or Oversize (3XL)**
- | Item   | Choose Color            | Ship  | Net     |
|--------|-------------------------|-------|---------|
| 550420 | Red/Black or Blue/Black | 1 lbs | \$17.99 |



**ADULT GENERAL PURPOSE • 4-PACK**

Clear, reusable storage bag with breathable mesh and carry strap.

- Contains four adult universal general purpose vests.**
- | Item   | Description                | Ship  | Net     |
|--------|----------------------------|-------|---------|
| 550427 | (2) Red and (2) Blue vests | 4 lbs | \$59.99 |



**THROWABLE FOAM CUSHION • USCG TYPE IV**

- Convenient webbing; grab straps/carry handles
  - Functional and comfortable PE foam
  - Strong, durable outer shell withstands abrasions
- | Item   | Choose Color       | Ship  | Net     |
|--------|--------------------|-------|---------|
| 550424 | White, Red or Blue | 2 lbs | \$13.99 |



**Kent Life Jackets**

**CHILD AND ADULT TYPE II LIFE JACKET** All ship 1 lbs

- Basic flotation provides minimum buoyancy
  - Turns an unconscious person face up in calm water
- Color: Safety Orange.
- | Item   | Size        | Net    | Item   | Size        | Net    |
|--------|-------------|--------|--------|-------------|--------|
| 550388 | Child small | \$8.99 | 550390 | Adult       | \$8.99 |
| 550389 | Youth       | 8.99   | 550391 | Adult L/3XL | 8.99   |



**STOWAGE BAG WITH (4) USCG TYPE II LIFE JACKETS**

- Convenient storage bag keeps your vests in one place
  - Contains (4) adult universal sized life jackets
- | Item   | Ship  | Net     |
|--------|-------|---------|
| 550392 | 4 lbs | \$43.99 |

**Pet Life Jackets**

**ONYX NYLON PET VEST**

- Designed to provide swimming endurance for your pet
  - Three adjustable body belts and quick release buckles for a secure fit
  - Durable nylon fabric to resist punctures and tears
  - Handler's strap for easy recovery
- Please specify size: XS (8-15 lbs), S (15-30 lbs), M (30-60 lbs), L (60-80 lbs) or XL (Over 80 lbs)**



Item	Color	Ship	Net
552736	Blue	1 lbs	\$15.99
552737	Stars & Stripes	1 lbs	15.99

**ONYX NEOPRENE PET VESTS**

- Designed to provide swimming endurance for your pet
  - Neoprene construction for added comfort, warmth and durability
  - Three adjustable body belts and quick release buckles for a secure fit
  - Reflective material on handler's strap
  - Zipper closure with hook and loop cover flap
- Please specify size: XS (8-15 lbs), S (15-30 lbs), M (30-60 lbs), L (60-80 lbs) or XL (Over 80 lbs)**



Item	Color	Ship	Net
552733	Red Plaid	2 lbs	\$27.99
552734	Green	2 lbs	27.99
552735	Purple	2 lbs	27.99

**PFDs & Life Jackets**

**ONYX UNIVERSAL PADDLE**

Offering comfort and performance for all paddlers with a "flex-cut" paddle-specific design where the foam is perforated and progressively tapered to reduce the front foam thickness and provide ease of paddling and a more contoured fit.

Item	Choose Size	Ship	Net
551367	Adult Universal or Adult Oversize	2 lbs	\$27.99



**ONYX YOUTH PADDLE**

This paddle-specific vest offers a better option for the youth paddler by providing a compact foam design, larger armholes, and side adjustments for better mobility and enhanced freedom of movement.

- Fits youth 50-90 lbs.

Item	Choose Color	Ship	Net
551368	Red or Yellow	1 lbs	\$24.99



**MERCHANT MATE™/OCEANMATE™ I • USCG TYPE I PFD**

- Keeps most wearers face-up • SOLAS approved
  - Reversible with reflective material and stainless steel hardware
- | Item   | Model | Size           | Color  | Ship  | Net     |
|--------|-------|----------------|--------|-------|---------|
| 552240 | 1100  | Adult > 90 lbs | Orange | 2 lbs | \$45.99 |
| 552241 | 1102  | Child < 90 lbs | Orange | 2 lbs | 45.99   |

**Ocean Mate I** – With attached SOLAS whistle

552429	1160	Adult > 90 lbs	Orange	3 lbs	69.99
--------	------	----------------	--------	-------	-------



**KENT USCG IMMERSION SUIT**

- Hi-vis yellow inflatable head pillow, face mask, mitts, and ankle adjustments for increased visibility in the water
- Removable head pillow for easy servicing
- Neoprene pocket for PLB and attachment point that fits all personal locator lights
- Gloves are positioned so sleeves turn at the elbows for easy donning
- Three fingered glove for added warmth
- 5 mm flame retardant neoprene
- SOLAS grade reflective material for increased visibility
- USCG approved/SOLAS compliant whistle attached.

Item	Model	Size	Ship	Net
552699	154000-200-020-13	Intermediate	13 lbs	\$304.99
	154000-200-004-13	Universal	13 lbs	304.99
	154000-200-005-13	Oversize	14 lbs	349.99
552700	Replacement bag select color/size		2 lbs	22.99



**STEARNS Safety and Survival**

**CREW MATE™ VEST • USCG TYPE I PFD**

- Body belt and chest strap • Light loop on shoulder
- Reflective material on panels • Contoured neck for comfort

Item	Model	Size	Color	Ship	Net
550038	1120	Adult Universal	Orange	2 lbs	\$49.99



**VERSATILE™ • USCG TYPE III PFD**

- Tough nylon shell • Seven piece foam design
- (4) roomy pockets • Eyelets for attaching lights, etc.
- Reflective stripes and rustproof Vislon® zipper

Item	Model	Size	Color	Ship	Net
552301	1465	S-3XL	International Orange	3 lbs	\$84.99



**MERCHANT MATE II™ • USCG TYPE I PFD**

- Body belt and foam-filled collar • Hinged back panel
- 210 denier nylon shell and lining • (2) Chest adjusters
- Reflective material on panels

Item	Model	Size	Color	Ship	Net
552242	1600	Adult > 90 lbs	Orange	3 lbs	\$62.99



**KENT USCG/SOLAS/MED IMMERSION SUIT**

- Complies with IMO RES 207(81) • Hi-vis yellow inflatable head pillow, face mask, mitts, and ankle adjustments for increased visibility in the water
- Removable head pillow for easy servicing • Sleeves turn at the elbows for easy donning • Stainless steel lifting harness • Easily accessible buoyant buddy line with snap hook
- Three fingered glove for added warmth • 5 mm flame retardant neoprene • SOLAS grade reflective material for increased visibility
- USCG approved/SOLAS compliant whistle attached • Neoprene pocket for PLB and attachment point that fits all personal locator lights

Item	Model	Description	Ship	Net
552701	154100-200-020-13	Intermediate	14 lbs	\$369.99
	154100-200-004-13	Universal	14 lbs	369.99
	154100-200-005-13	Oversize	16 lbs	389.99
552700	Replacement bag select color/size		2 lbs	22.99





PFDs & Life Jackets

SPINLOCK DECK VEST VITO INFLATABLE PFD



NEW!

- Durable rip stop fabric
- 170N buoyancy with Hammar® hydrostatic automatic inflator
- Structured fit allows easy donning with simple to adjust buckles
- Course and fine tune adjustment
- Structured sprayhood to reduce the risk of secondary drowning
- Lume-On™ - Lifejacket bladder illumination lights included
- Pylon Lifejacket Light™ - high intensity, water activated flashing LED Light. 23 cm flexible antenna wand gives improved visibility above head, water
- Wider 40 mm leg strap with stowage
- Buoyancy rating: 38 lbs

Size: Universal adult Color: Black

Item	Model	Description	Ship	M.A.P.
Ⓞ 551265	DW-VT/H170	VITO PFD	3 lbs	\$399.00
Ⓞ 551266	DW-RAH/V170	VITO re-arm kit	1 lbs	85.00



Note: This vest is not an approved USCG flotation device

SPINLOCK DECKVEST 5D PRO SENSOR ELITE PFD

- Deckvest 5D inflatable PFD with harness and Pro Sensor Elite cartridge has two indicators that show the status of the CO2 cylinder and firing head
- Pylon Light™: High intensity, water activated flashing LED light
- Lume-On™: Lifejacket bladder illumination lights included
- Deck safety harness with soft loop safety line attachment point
- Double crotch straps
- Includes a sprayhood to reduce the risk of secondary drowning
- Quick access emergency safety line cutter
- Through Life Support (TLS) registration extends product warranty to 5 years

Please specify size: 1, 2 or 3

Please specify color: Gun Metal/Black, Pacific Blue or Tropic White

Item	Model	Description	Ship	Net
Ⓞ 551050	DW-LJH5D	Pro Sensor Elite PFD	4 lbs	\$368.99
Ⓞ 551267	DW-RAK/E170	Pro Sensor Elite re-arm kit	1 lbs	41.99

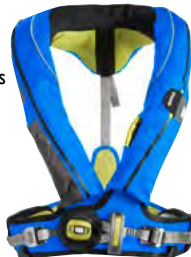

Note: This vest is not an approved USCG flotation device

SPINLOCK DECKVEST LITE INFLATABLE PFD

- US Coast Guard Approved
- Automatic inflation with manual backup
- Converts to "manual only" with a conversion kit (sold separately)
- Designed to be worn when participating in a variety of sports
- Ultra-lightweight low-profile life jacket
- Straps with soft rear moulding
- Single crotch strap with recessed clip reduces risk of snagging
- Provides 38 lbs buoyancy when inflated
- Accessory attachment points
- Extended 5-year limited warranty upon registration

Size: Universal Adult

Please specify color: Gun Metal/Black, Pacific Blue or Tropic White

Item	Model	Description	Ship	Net
Ⓞ 550557	DW-LCG	Deckvest Lite PFD	3 lbs	\$198.99
Ⓞ 550558	DW-RAR/33G	Deckvest Lite re-arm kit	1 lbs	41.99
550559	DW-RMAK	Manual Conversion kit	1 lbs	18.99



Revere Inflatable PFDs



REVERE COMFORTMAX™ INFLATABLE VESTS

- USCG approved for persons at least 16 years of age weighing 80 lbs + with a chest size 30" - 52"
- 35 lbs of buoyancy
- Dual waist belt with stainless steel adjusters
- Exterior inflation system access flap - direct access to the cylinder
- Heavy duty 420 denier nylon packcloth outer cover
- Includes whistle and SOLAS grade retro-reflective tape

Please specify color: Red or Navy

Item	Description	Ship	Net
Ⓞ 550138	Manual inflation; Type III	3 lbs	\$104.99
Ⓞ 550139	Automatic inflation; Type II	3 lbs	124.99
Ⓞ 550140	Manual inflation with harness; Type V	4 lbs	146.99
Ⓞ 550141	Automatic inflation with harness; Type V	4 lbs	165.99
Ⓞ 550097	45-RAKM Re-arm kit for items 550138 and 550140	1 lbs	20.99
Ⓞ 550098	45-RAKA Re-arm kit for items 550139 and 550141	1 lbs	24.99



REVERE ADULT COMFORTMAX MANUAL BELT PACK • USCG TYPE III

- USCG approved for persons at least 16 years old and weighing 80 lbs.+ with a chest size 30" - 52"
- Includes whistle and D-ring in pouch
- Buoyancy: 35 lbs
- 210 Denier - urethane coated
- Reflective tape
- Clear status window
- Mechanism: 3F
- CO2: 33 Gram

Please specify color: Navy or Red

Item	Description	Ship	Net
Ⓞ 550430	Universal; Manual	2 lbs	\$89.99
Ⓞ 550097	45-RAKM Re-arm kit	1 lbs	20.99



CREWFIT 40 PRO USCG

- USCG TYPE II APPROVED LIFEJACKET (AUTO)
- USCG TYPE V / II APPROVED LIFEJACKET (AUTO + HARNESS)
- USCG TYPE III APPROVED LIFEJACKET (MANUAL)
- USCG TYPE V / III APPROVED LIFEJACKET (MANUAL + HARNESS)

- Provides 40 lbs of buoyancy when inflated
- Soft loop D-rings for attaching the safety harness on harness versions
- Form-fitting design allows for greater range of head movement
- Fusion 3D shaping and flexible fabric for a comfortable fit
- Indicator window shows status of firing mechanism
- Twin, forward pull side waist adjusters
- Robust outer cover
- YKK quick burst zip (QBZ) closure
- Webbing tidys
- Can be fitted with a personal AIS device
- Manual inflation tube
- Retro-reflective tape improves visibility
- Unique chin support tilts your head back to help keep your airways clear
- Halkey Roberts PRO 1F (Automatic) or PRO 3F (Manual) operating heads
- Bladder turns you onto your back supporting your head
- Color: Black

Item	Description	Ship	Net
Ⓞ 552552	Manual	2 lbs	\$146.99
Ⓞ 552553	Automatic	3 lbs	157.99
Ⓞ 552554	Manual with harness	3 lbs	147.99
Ⓞ 552555	Automatic with harness	3 lbs	169.99



Provides 40 lbs of buoyancy when inflated

CREWSAVER ERGOFIT 40 PRO

- USCG TYPE V / II APPROVED LIFEJACKET (AUTO + HARNESS)

- Provides 40 lbs of buoyancy when inflated
- Three-layer cover construction for extreme durability
- Dual buckle system to enable easy donning
- Soft loop D-rings for attaching the safety harness
- Easy to adjust side waist adjusters and quick burst zip
- USCG approved
- Color: Black

Item	Description	Ship	Net
Ⓞ 552556	Auto with harness	4 lbs	\$217.99



FIND MORE



CREWSAVER

PFDs AT WWW.DEFENDER.COM

IMPERIAL IMMERSION SUITS

USCG APPROVED

- 1-piece, sealed construction
- Buoyant 5 mm neoprene
- Three-fingered mitt increases dexterity
- Palm grip studs for improved grasping
- Equipped with whistle
- Dual-zipper pull tabs
- Snug-fitting face seal helps keep water out
- SOLAS-grade reflective tape provides extra visibility
- Includes sturdy storage bag with two handles for quick retrieval and donning of suit
- Inflatable high-rider ring for additional freeboard and buoyancy

Item	Model	Size	Ship	Net
550710	80-1409-C	Child	8 lbs	\$279.99
	80-1409-O	Adult intermediate	13 lbs	279.99
	80-1409-A	Universal adult	13 lbs	279.99
	80-1409-J	Jumbo	14 lbs	307.99



USCG APPROVED/SOLAS COMPLIANT

- Three-fingered mitt
- Wide legs
- Dual-zipper pull tabs
- Back straps
- 1 piece, sealed construction
- Inherently buoyant
- Snug-fitting face seal is flexible and comfortable
- Retro-reflective tape for extra visibility
- Sturdy storage bag with (2) handles
- Suits made of 3/16" neoprene
- Inflatable high-rider ring for additional freeboard and buoyancy
- Comes with whistle, buddy line and lifting harness

Please specify size: Adult intermediate 59 - 70" (up to 180 lbs) or Universal adult 59-75" (110 - 330 lbs.) or Jumbo 6'3"+ (220+ lbs)

Item	Model	Adult Size	Ship	Net
552437	80-1409-O-3	Adult intermediate	12 lbs	\$317.99
	80-1409-A-3	Universal adult	14 lbs	317.99
	80-1409-J-3	Jumbo	14 lbs	339.99



## Tethers, Jacklines & Harnesses

### WICHARD PROLINE SAFETY TETHER

- Wichard's Proline tethers offer maximum safety ErgoLockSystem (patented): Automatically closes and locks the snap hook
- Removable snap hook lets you increase the lifespan of the product by replacing the webbing only
- Locking indicator
- Retro-reflective webbing; visible at night
- Overload indicator
- Easy to use
- V-nose (patented): special tip makes hooking and unhooking easy with one hand
- Wide opening snap hook (26 mm)
- Approvals: ISO 12401:2009 and ISAF regulations (OSR)



Item	Model	Configuration	Ship	Net
552560	7031	2.0 m, Single, elastic with (2) safety snap hooks	1 lbs	\$204.99
552561	7032	.8 m, Single non-elastic with (1) safety snap hook and (1) loop	1 lbs	128.99
552562	7033	1.4 m, Single elastic with (1) safety snap hook and (1) loop	1 lbs	153.99
552563	7034	2 m and 1 m, Double elastic with (3) safety snap hooks	2 lbs	256.99

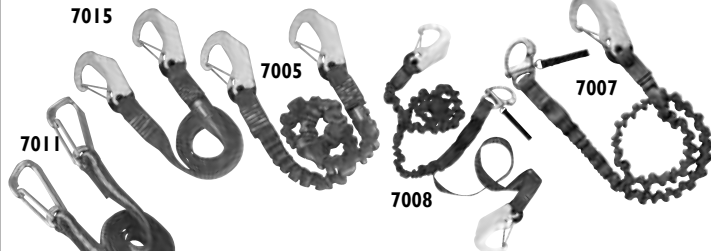

### WICHARD QUICK RELEASE SAFETY TETHERS

- Heavy duty tubular nylon webbing
- Snap shackles are drop forged and provide quick release
- Glow in the dark safety hooks require rear of hook to be pressed to prevent accidental opening
- Spring locked carbine hooks are asymmetric stainless steel
- All are 2 meters long legs are 1 meter fixed on double models
- All have 4,580 lbs breaking strength

Item	Model	Configuration	Ship	Net
552025	7007	Single elastic with snap shackle/safety hook (ORC/OSR-ISAF)	1 lbs	\$134.99
552106	7008	Double elastic with snap shackle/safety hooks (ORC/OSR-ISAF)	2 lbs	201.99
551071	7005	Single elastic with safety hooks	1 lbs	157.99
551072	7006	Double elastic with safety hooks	2 lbs	189.99
551073	7015	Single non-elastic with safety hooks	1 lbs	123.99
551069	7011	Single non-elastic with carbine hooks	1 lbs	94.99
551068	7002	Double elastic with carbine hooks	2 lbs	170.99
551067	7001	Single elastic with carbine hooks	1 lbs	111.99

### SOSPENDERS SAFETY TETHER

(1) 6' (under load) tether with (1) Wichard hook and (1) quick release hook. Elastic design contracts to take up slack when not under load. High-strength nylon webbing with lock-stitched, three-cord thread. Stainless steel hardware.

Item	Model	Ship	Net
552250	G325ACC-00-000	1 lbs	\$149.99

## Safety Knives & Tools

### SPINLOCK EMERGENCY S-CUTTER

- An emergency escape accessory with guarded razor edge
- Designed for severing safety lines when under load
- Satisfies ISAF and ORC recommendations

Item	550240	Model	DW-CTR	Ship	1 lbs	Net	\$23.99
------	--------	-------	--------	------	-------	-----	---------

### MYERCHIN OFFSHORE SAFETY / DIVE PRO KNIFE

- Blade type: serrated, on-folding, sheepfoot blade design
- Blade length: 3.8" Total length: 8.5"
- Material: pro-grade German marine stainless steel

Item	605822	Model	A510P	Ship	1 lbs	Net	\$49.99
------	--------	-------	-------	------	-------	-----	---------

### GILL MARINE TOOLS

- Titanium coated 420 stainless steel

Item	Model	Ship	Net
550610	MT006 Rescue Knife	1 lbs	\$35.99
550611	MT007 Marine Tool	1 lbs	39.95
550612	MT008 Harness Rescue Tool	1 lbs	22.95

- Serrated blade edge, liner lock, one-handed opening
- Serrated blade, integrated shackle key, web cutter, 8mm spanner, marlin spike
- Shackle key fits most small to medium shackles, web cutter

### SUNCOR DOUBLE JACKLINE WITH CLIP

- Combines the strength of high quality webbing with a durable, corrosion-resistant grade 316 stainless steel heavy-duty harness clip.
- Includes (2) lengths of webbing connected to the heavy duty clip and heat sealed on the ends.



Item	Model	Length each side	Ship	Net
608485	C0240-0035-B	35'	3 lbs	\$99.99
	C0240-0045-B	45'	3 lbs	109.99

### WICHARD LYF'SAFE JACKLINE LOOP KITS

Adaptable and universal, LyfSafe can be tailored to the length of the boat (using the adjuster) and can be fitted on to most deck fastenings.

**Ready-to-use:** Easy to install, LyfSafe does not require additional fastening components such as shackles.

**Reflective:** Thanks to its reflective stripe and photoluminescent casings, LyfSafe can be easily identified when sailing at night.

**Locking system of the webbing:** The adjuster casing prevents any accidental adjustment or release of the webbing.

**Resistant:** The anti-abrasion edges to the webbing prevent early wear and fraying.

**Anti-chafing:** The soft elastomer casing isolates the deck, eliminating noise and vibrations.

**LyfSafe includes:** (2) webbings (material: polyester) with (1) end with a loop and (1) free end, (2) forged adjusters and (2) casings

Item	Model	Length	Ship	Net	Item	Model	Length	Ship	Net
550974	7051	8.5 m	4 lbs	\$163.99	550974	7053	14 m	6 lbs	\$233.99
	7052	11 m	5 lbs	192.99		7054	16 m	6 lbs	272.99

### SPINLOCK DECKWEAR SERIES TETHERS

These safety lines are lighter and more compact for performance sailing. Color: Black and Yellow.

- Dry-coated to prevent water absorption and reduce weight gain
- Overload indicator displays when load exceeds 500 kgs
- Approvals: CE, EN1095, ISO12401

- Tethers are 2M long (3 leg versions have a 1M leg)

Item	Configuration	Retractable	Attachment Type	Ship	Net
550457	Single	Yes	(2) hooks	1 lbs	\$96.99
550458	Double	(1) yes, (1) fixed	(3) hooks	2 lbs	139.99
550459	Single	No	(1) hook, (1) loop	1 lbs	74.99
550460	Single	Yes	(1) hook, (1) loop	1 lbs	91.99
550461	Double	(1) yes, (1) fixed	(2) hooks, (1) loop	1 lbs	124.99

## Crotch Straps

### SOSPENDERS CROTCH STRAP

Adds extra security to any SOSPENDERS PFD. Includes heavy-duty webbing buckle and D-ring. Meets ORC safety requirements. Attaches quickly. Universal adult size.

Item	Model	Ship	Net
552249	G339ACC-00-000	1 lbs	\$14.99

### CREWSAVER CROTCH STRAPS

Fit to your inflatable lifejacket's or buoyancy aid's attachment points for a more secure fit and to hold you in a safer position in the water. Can be retro-fitted to all inflatable lifejackets.

Item	Model	Ship	Net
552559	10032	1 lbs	\$11.99

## Harnesses

### PLASTIMO ADJUSTABLE SAFETY HARNESS

- Adjustable at waist and shoulder
- Back patch holds shoulder straps in position
- Attachment points are stainless steel triangles
- Reflective tape and toggles for fastening on jacket

Item	Model	Size	Ship	Net
552143	31550	Adult	2 lbs	\$119.99
552144	31551	Child	2 lbs	109.99

### SOSPENDERS SAFETY HARNESS

- Multi-color webbing w/reflective tape
- Nylon webbing sewn with lock-stitched three-cord thread
- Chest Size: M (32-44") or L (44-58")

Item	Color	Ship	Net
550107	Red/Yellow	2 lbs	\$77.99

## Spray Hood

### CREWSAVER CREWFIT UNIVERSAL SPRAY HOOD

Package Includes:

- Fluorescent Yellow spray hood
- Storage pouch

Features:

- Stored in a pouch on the waist band
- For use in the water
- Fits over the wearer's head and the inflated lifejacket
- Reduces spray being inhaled

Item	551005	Model	55-10057	Ship	1 lbs	Net	\$29.99
------	--------	-------	----------	------	-------	-----	---------





## Rescue Lights/Distress Lights

### WEEMS & PLATH SOS DISTRESS LIGHT WITH DISTRESS FLAG

- USCG approved alternative to pyrotechnic marine flares and flare guns
- Visible up to 10 nautical miles • Made in the USA • Floats
- Power: (3) C Batteries (not included) • Lifetime warranty
- One time purchase: no expiration date; no disposal is required
- Provides an omni-directional light display for surface rescue craft and a vertical beam visible to aircraft flying overhead
- Fulfills all Coast Guard requirements for marine distress signals when combined with the included distress flag
- 36" x 36" Coast Guard-compliant Orange distress flag fulfills the legal requirement for "Day Visual Distress Signal for Boats"



Item	Model	Ship	Net
550696	C-1001	2 lbs	\$89.99

### WEEMS AND PLATH PERSONAL RESCUE STROBE

- Waterproof • Heavy-duty, military grade construction is comparable to lights used in deep-sea diving • Manually activated strobe operates with (1) AA battery • A powerful 200 Lumens LED bulb is housed in an unbreakable Lexan lens and flashes 60 times per minute • The unique light cone extends visibility, making it 4x brighter than average compact strobes

Item	Model	Visibility	Ship	M.A.P.
550985	S-1001	2+ miles, 360 degree omni-view	1 lbs	\$59.99

### ACR C-STROBE™ H2O

#### • WATER ACTIVATED PERSONAL DISTRESS STROBE LIGHT

- Manual on/off button or water activation personal distress strobe light. **Lamp:** 45 lumen White LED **Visibility:** 360° **Battery Type:** 2 "AA" alkaline (not included) **Life:** 120 hours continuous **Size:** 5.56" x 1.38" x 1.2" **Approval:** USCG/SOLAS, CE, Transport CAN **Warranty:** Limited 1 year

Item	Model	Ship	Net
552569	3964.1	1 lbs	\$20.99

### ACR AUTO HEMILIGHT3 AUTOMATIC SURVIVOR LOCATOR LIGHT WITH STROBE

- Water activated. USCG approved for use in life vests and rafts.

- Lamp:** LED strobe **Battery Type, Life:** 5-year, lithium; 20 hrs

Item	Model	Visibility	Weight	Ship	Net
552576	3764.1	Over 1 mile	1.8 oz	1 lbs	\$19.99

### ACR C-STROBE™

#### • MANUAL ACTIVATION

- Manually twist on/off activation personal distress strobe light. **Lamp:** 45 lumen White LED **Visibility:** 360° **Battery Type:** 2 "AA" alkaline (not included) **Life:** 120 hours continuous **Size:** 5.06" x 1.38" x 1.2" **Approval:** USCG/SOLAS, CE, Transport CAN **Warranty:** Limited 1 year

Item	Model	Ship	Net
552570	3965.1	1 lbs	\$16.99

### ACR FIREFLY PRO WATERBUG SOLAS STEADY/STROBE/SOS LIGHT

- (4) activation functions (Armed mode for automatic water activation, ultra-bright strobe light, SOS strobe or Steady-On)
- Operation:** Manual on/off switch and water activation, 56 hours strobe, 28 steady-on **Waterproof:** Factory tested to 33' **Lamp:** LED - Cool White **Intensity:** 41 Candela (strobe) **Flash Rate:** 60 P/M +/-
- Operation:** 56 hours minimum **Dimensions:** 4.4" x 2.2" x 1.2"

Item	Model	Visibility	Weight	Approval	Ship	Net
550521	3971.3	3.2 miles+	2.39 oz.	SOLAS/USCG	1 lbs	\$74.99

### AQUASPEC AQ40S HIGH PERFORMANCE LED LIFEJACKET LIGHT

- The AquaSpec AQ40S is a compact, flashing lifejacket light • Activation: Automatic by its integral water sensors or manually • Powerful flashing White LED light • Battery Type: Lithium • Maintenance free five year battery life • Duration minimum: 40 hrs • Output minimum: 2.5 cd Light
- Light Storage Life: 5 Years from date of manufacture • Approvals: SOLAS (LSA Code), ISO24408, USCG, USCG SOLAS

Item	Model	Dimensions	Ship	Net
550822	45-LIF2077	1.2" D x 0.8" W x 2" L	1 lbs	\$19.99

### FORESPAR WL-1 FLOATING STROBE

- Flashes automatically when thrown overboard. Stainless steel mounting bracket included. Visible for miles at sea. **Lamp:** LED strobe **Visibility:** 360° omni-directional **Battery Type:** 6 VDC alkaline lantern (not included) **Life:** 52 hrs

Item	Model	Weight	Approval	Ship	Net
550957	205102	1.2 lbs	USCG	2 lbs	\$154.99

### PLASTIMO FLOATING LIFEBOUY LED LIGHT

- Very compact with low consumption. **Lamp:** LED **Visibility:** 360° arc.

- Battery Type:** D (not included) **Life:** 8 hrs at 60 flashes/min

Item	Model	Light intensity	Approval	Ship	Net
550177	196482	2 candela	SOLAS	1 lbs	\$39.99
550178	37034	Rail mount clip		1 lbs	20.99

### ORION ELECTRONIC SOS BEACON / LOCATOR KIT

- USCG-Approved alternative to pyrotechnic marine flares
- Power: 2 D-batteries (Not included) • One time purchase: No expiration date, no disposal needed • Beacon complies with U.S. Coast Guard requirements for "Night Visual Distress Signals"
- Flag complies with U.S. Coast Guard requirements in 33 CFR 175.130 daytime signaling • Flashes bright "SOS" distress signal in Morse code 2x longer and maintains constant light intensity 2.5x times longer than USCG continuous run-time requirement
- Multiple deployment options: Floatable, handheld, hanging



Item	Model	Ship	Net
552721	547	2 lbs	\$89.99

### ACR FIREFLY PRO SOLAS STROBE/STEADY/SOS LIGHT

- Operation:** Manual on/off switch **Waterproof:** Factory tested to 33' **Lamp:** LED - Cool White **Strobe Intensity:** 41 Candela minimum **Strobe Flash Rate:** 60 P/M +/- **Strobe Operation:** 56 hours minimum **Size:** 4.4" x 2.2" x 1.2"

Item	Model	Visibility	Weight	Approval	Ship	Net
550520	3970.3	3.2+ Miles	2.39 oz.	SOLAS/USCG	1 lbs	\$69.99

### ACR SM-2 AUTOMATIC CREW-OVERBOARD MARKER LIGHT

- Features a bulkhead bracket. Throw overboard or turn upright to activate. **Lamp and angle:** Xenon flash tube and Omni-directional 360° **Battery Type:** 6 VDC Lantern-style **Life:** min. 36 hrs continuous **Size:** 13.8" x 4.8"

Item	Model	Visibility	Weight	Approval	Ship	Net
551285	3940.1	3 Nm	3.4 lbs w/battery*	USCG	4 lbs	\$129.99

\*Ships without battery

### ACR C-LIGHT™

#### • MANUAL ACTIVATION

- Manually twist on/off activation steady-on personal distress light. **Lamp:** 20 Lumen White LED **Visibility:** 360° **Battery Type:** 2 "AA" alkaline (not included) **Life:** 30 hours continuous **Size:** 5.06" x 1.38" x 1.2" **Approval:** USCG/SOLAS, CE, Transport CAN **Warranty:** Limited 1 year

Item	Model	Ship	Net
552568	3963.1	1 lbs	\$12.99

### ACR C-LIGHT™ H2O

#### • MANUAL OR WATER ACTIVATION

- Manual on/off button or water activation steady-on personal distress light. **Lamp:** 20 Lumen White LED **Visibility:** 360° **Battery Type:** 2 "AA" alkaline (not included) **Life:** 30 hours continuous **Size:** 5.56" x 1.38" x 1.2" **Approval:** USCG/SOLAS, CE, Transport CAN **Warranty:** Limited 1 year

Item	Model	Ship	Net
552567	3962.1	2 lbs	\$18.99

### ACR L8-3 PERSONAL RESCUE LIGHT- USCG APPROVED

- Water activated. USCG approved for use in life vests and rafts. **Lamp:** Incandescent strobe **Battery Type, Life:** Cuprous iodide; 8 hours

Item	Model	Visibility	Weight	Ship	Net
550945	3720.018	Over 1 mile	1.8 oz	1 lbs	\$18.99

### UST SEE-ME 1.0 STEADY-ON LED PERSONAL LOCATOR LIGHT

- Manual twist on/off • USCG approved • Provides 20 lumens of light
- Runs for 17 hrs continuously • Can be seen up to 3.4 miles away in complete darkness • Lifetime LED bulb never needs to be replaced
- Uses (2) AAA alkaline batteries (not included)
- Dimensions: 5" H x 1" W • Lifetime limited warranty

Item	Model	Ship	Net
552573	20-51150-08	1 lbs	\$8.99

### UST SEE-ME 1.0 LED STROBE PERSONAL LOCATOR LIGHT

- Manual twist on/off • USCG approved • Provides 28 lumens of light
- Runs for 44 hrs continuously • Can be seen up to 2.7 miles away in complete darkness • Lifetime LED bulb never needs to be replaced
- Uses (2) AAA alkaline batteries (not included)
- Dimensions: 5" H x 1" W • Lifetime limited warranty

Item	Model	Ship	Net
552574	20-51152-08	1 lbs	\$12.99

### UST SEE-ME 2.0 WATER ACTIVATED LED STROBE PERSONAL LOCATOR LIGHT

- Manual twist on/off • USCG approved • Water-activated
- Provides 45 lumens of light • Runs for 120 hrs continuously
- Lifetime LED bulb • Rated waterproof IPX7 • Can be seen up to 3 miles away in complete darkness • Uses (2) AA alkaline batteries (not included)
- Dimensions: 5.5" H x 1.5" W • Lifetime limited warranty

Item	Model	Ship	Net
552575	20-4075A-08	1 lbs	\$25.99

## Signal Mirror, Whistles & Key Float

### ACR HOT SHOT SIGNAL MIRROR AND WHISTLE

- Telescope quality, second surface reflective mirror
- Floats and meets USCG regulations for audible alerting in low visibility conditions (includes lanyard float)
- Item 552083 Model 1700 Ship 1 lbs Net \$18.99

### ACR WW3 RES-Q WHISTLE

- USCG compliant • Plastic 2-tone whistle, up to 102dB
- Flat design prevents it from holding water • 31.5" lanyard
- Item 550919 Model 2228 Ship 1 lbs Net \$4.69



### PLASTIMO 2-TONE EMERGENCY WHISTLE

- Material: Orange polystyrene • Lanyard not included
- Works when wet • "Pea-less" design
- Item 550543 Model 16303 Ship 1 lbs Net \$1.99

### DAVIS SELF-INFLATING KEY BUOY

- Never lose keys in the water again! Bright Orange air tube maintains buoyancy on the surface of the water for about 40 minutes. Air tube is 14" long when inflated. For single use only.
- Item 550004 Model 530 Ship 1 lbs Net \$6.99



**AIS & MOB**

**WEEMS & PLATH CREWWATCHER BLUETOOTH MOB ALARM SYSTEM**

- Free app operates on most smartphones and tablets
- Tracks beacon when activated (Activation by submersion or separation)
- Alerts with beacon location and direction on screen
- Up to a 200 meter line of sight range
- 30x faster response than personal AIS beacon
- Perfect for monitoring: crew members, children, pets, dinghy, bilge level, etc

Item	Model	Number of Beacons	Ship	Net
Ⓞ 550983	CREW1	1	1 lbs	\$89.99
Ⓞ	CREW2	2	2 lbs	169.99



**NEW!**

**OCEAN SIGNAL RESCUER MOB1 PERSONAL LOCATING AIS**

- Ocean Signal MOB1 personal locating AIS man overboard device with DSC is the world's smallest AIS MOB device with integrated DSC
- Automatic activation, 24+ hours operational life, 7 year battery life
- Transmission range: Up to 5 miles

Item	Model	Description	Ship	Net
Ⓞ 552716	740S-01551	Personal locating AIS	1 lbs	\$279.95



**MCMURDO SMARTFIND S20 SURVIVOR RECOVERY SYSTEM PERSONAL AIS**

- Provides accurate position information for fast recovery
- Transmits GPS target tracking information to plotters and onboard navigation systems
- Auto/Manual activation
- Small and lightweight for mounting on lifejacket
- AIS channel 1 -161.975MHz, AIS channel 2 - 162.025MHz
- Unique serialized ID
- Message 1 (UID, GPS position, SOG, COG, UTC)
- Message 14 (MOB ACTIVE or MOB TEST)
- 50-channel GPS
- Minimum 24 hour continuous operation
- Typical 4 NM transmit range
- LED flashing indicator
- 7 year battery life

Item	Model	Description	Ship	Net
Ⓞ 552434	98-001-002A	Personal locating AIS	1 lbs	\$249.99



**PLBs**

**ACR RESQLINK+™ PLB**

Small and buoyant at 5.4 oz and just 4.5", the ResQLink+ personal locator can be stored inside an inflatable life jacket. GPS positioning, 406 MHz signal, and 121.5 MHz homing capability enable a worldwide network of satellites to locate you quickly and accurately. A built-in strobe aids in night rescues. The ResQLink+ activates easily in any conditions, simply deploy the antenna and press the ON button. Its 66-channel GPS is accurate to within 100 m or less. In the continental US this means rescue personnel are typically alerted of your position in as little as five minutes.

- Performance: over 24 hours @ -4°F (-20°C)

- Battery: non-hazmat; replaced 6 years from date of manufacture
- Warranty: 5 years
- Manual activation
- Dimensions: 1.6" x 1.9" x 4.5"
- Waterproof to 33 Ft/10 M
- 66 Channel GPS receiver
- Weight: 5.4 oz.

Item	Model	Ship	Net
Ⓞ 550429	2881	1 lbs	\$289.95

**ACR PLB-350C AQUALINK VIEW 406 PLB GPS**

- High visibility digital screen displays GPS LAT/LON, operating instructions, usage tips, transmission bursts as well as battery power
- 406 MHz signal - 121.5 MHz homing capability
- Typical performance 30 hrs @ -4°F
- Includes: belt clip and lanyard
- Super bright LED strobe
- On-board 66 channel GPS
- Enhanced GPS acquisition test feature
- Waterproof to 5 m / 16.4 ft. (10 m / 33 ft. for 10 minutes)
- Non-hazmat battery - must be replaced 6 yrs from manufacture date
- Dimensions: 2.3" x 5.8" x 1.45"
- Manual activation
- Buoyant
- Warranty: 5 years
- Electronic witness seal
- Weight: 9.2 oz.

Item	Model	Ship	Net
Ⓞ 550233	2884	1 lbs	\$379.99

**ACR AQUALINK™ 406 MHZ GPS PLB-350B**

All the features of the AquaLink View without the digital display and with 35 hours of typical performance @ -4°F.

Item	Model	Ship	Net
Ⓞ 552363	2882	2 lbs	\$339.99



**NEW!**

**RESCUEME PLB1 PERSONAL LOCATOR BEACON**

- Easily fits in lifejacket
- 7 year battery life
- 24+ hour operational life
- High intensity (1 candela) strobe
- Operates on the global Cospas Sarsat rescue system
- Free to use, no subscription charges
- Supplied with free flotation pouch
- No subscription required - Link via satellite to emergency services
- Retractable antenna
- 7 year warranty
- 66 channel GPS receiver
- Unique mounting clip
- Waterproof to 15 m
- Fast accurate positioning

- Homing beacon to aid final location by search and rescue craft
- Frequency: 406.040 MHz (satellite transmitter), 121.5 MHz (homing beacon)
- Operating temperature range: -20° C to +55° C
- Dimensions: 3" H x 2.1" W x 1.3" D

Item	Model	Ship	Net
Ⓞ 551277	730S-01261	1 lbs	\$279.95

**EPIRBs**



**ACR GLOBALFIX™ V4 EPIRB**

A marine distress beacon with multiple built-in redundancies to increase your chances of survival in an emergency situation. The internal GPS will pinpoint your location which is transmitted on the 406 MHz distress signal, which, in the absence of GPS coordinates, can be used to triangulate your position. The beacon's 121.5 MHz homing signal will bring local search and rescue forces directly to your position, and the EPIRB's LED strobe light will allow them to visually locate your position in low light environments.

- New lanyard configuration; easier deployment
- Highly visible LED strobe - Energy efficient
- Internal 66 channel GPS - Faster acquisition from a cold start
- User replaceable battery - 10 year battery life
- Simple manual activation - Keypad with protective cover to prevent false alarms
- Uses search and rescue satellites - No subscription fees
- Material: high impact UV resistant polymer



Item	Model	Description	Ship	Net
Ⓞ 552530	2830	GlobalFix V4 - Category 1: Automatic	6 lbs	\$549.95
Ⓞ 552531	2831	GlobalFix V4 - Category 2: Manual	4 lbs	449.95
Ⓞ 552532	1104	GlobalFix V4 - User replaceable battery	1 lbs	115.99

**ACR GLOBALFIX PRO 406 MHZ GPS EPIRB - NO DIGITAL DISPLAY**

Frequency: 406 MHz with 121.5 MHz homing signal

Battery type: Class 2 (non-hazmat) lithium batteries

Battery life: 5 year storage/48 hrs minimum or 65+ hours typical

Strobe: White LED; 20-30 flashes per minute

GPS: internal GPS receiver

Waterproof: Yes

Weight: 20.5 oz.

Item	Model	Description	Ship	Net
Ⓞ 550189	2842	Category I: Auto hydrostatic release	5 lbs	\$599.95
Ⓞ 550190	2844	Category II: Manual detachment release	4 lbs	499.95



**ACR GLOBALFIX IPRO 406 MHZ GPS EPIRB - WITH DIGITAL DISPLAY**

Frequency: 406 MHz with 121.5 MHz homing signal Battery type: Class 2 (non-hazmat) lithium batteries Battery life: 5 year storage/48 hour operation Strobe: White LED; 20-30 flashes per minute GPS: Internal GPS receiver Waterproof: Yes Weight: 20.5 oz.

Item	Model	Description	Ship	Net
Ⓞ 552352	2846	Category I: Auto hydrostatic release	6 lbs	\$759.95
Ⓞ 552353	2848	Category II: Manual detachment release	4 lbs	659.95

**OCEAN SIGNAL RESCUER EPIRB1**

- 30% smaller
- 10 year battery life
- 5 year warranty
- Fast accurate positioning
- Retractable antenna
- Manual release bracket
- Secure lanyard
- Auto activates on immersion
- Link via satellite to emergency services
- Homing beacon to aid final location by search and rescue craft
- Satellite transmission: 406.040 MHz, 12 Watts (Max EIRP)
- Homing transmission: 121.5 MHz, 50 mW nominal
- Operation life: Up to 48 hrs at -20° C (-4° F)
- Operating temperature range: -20° C to +55° C (-4° F to +131° F)
- Dimensions: 7" H x 3.9" W x 3.5" D

Item	Model	Ship	Net
Ⓞ 551276	702S-01540	2 lbs	\$399.95

**NEW!**



Like Defender on Facebook for the latest boating news & information and upcoming SALE promotions!  
[Facebook.com/DefenderIndustries](https://www.facebook.com/DefenderIndustries)



## Ring/Horseshoe Buoys, Holders & Accessories

### JIM BUOY LIFE RINGS

USCG approved. Solid, closed cell foam. Double UV inhibitor web straps to prevent deterioration. Will not rot or mildew.

Please Specify Color: Orange or White

Item	Model	Dia.	Ship	Net
550981	G-19	19" (White only)	3 lbs	\$65.99
550982	GO-20/GW-20	20"	3 lbs	72.99
550984	GO-24/GW-24	24"	3 lbs	79.99
550986	GO-30/GW-30	30"	5 lbs	89.99



### JIM BUOY SOLAS INTERNATIONAL RING BUOY

USCG and SOLAS approved. Vinyl coated nylon covered rigid urethane foam construction. Rope nut makes rope changes easy. Color: Orange. 5 Year warranty.

Item	Model	Dia.	Ship	Net
550989	JBSO-30	30"	7 lbs	\$94.99

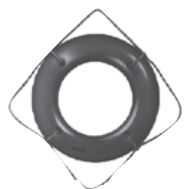

### JIM BUOY LIFE RING SAFETY STATION

• Protects buoy from the elements • Polycarbonate, non-breakable window

• Package includes:

Item	Model	Ring Dia.	Ship	Net
550286	5030A-60-WW	20"	18 lbs	\$227.99
550287	5050A-60-WW	24"	20 lbs	297.99



### JIM BUOY HORSESHOE BUOYS

• USCG approved • Yellow • Durable vinyl • Piped edges • Heavy duty zipper • Closed cell plastic core • Will not rot or mildew

• All hardware throughout is stainless steel • Floats indefinitely

Item	Model	Size / Dimensions	Ship	Net
550978	940	Pony / 23" W, 20-1/2" H and 3-1/4" thick	2 lbs	\$97.99
550977	920	Full / 24" W, 24" H and 3-1/4" thick	3 lbs	114.99



### JIM BUOY AMERICA'S CUP

Horseshoe buoy plus sea anchor that slows buoy drift when blown in water. USCG approved. White.

Item	Model	Size	Ship	Net
550980	1040	Pony / 23" W x 20-1/2" H and 3-1/4" thick	3 lbs	\$114.99
550979	1020	Full / 24" W x 24" H x 3-1/4" thick	3 lbs	154.99

### JIM BUOY ROUGHNECK LIFE RING RACK

Vertical and horizontal mounting bracket for 30" life ring. Heavy-duty, welded stainless steel construction. Optional "U"-bolts for stanchion line mounting.

Item	Model	Ship	Net
550990	1123-30 Ring rack	6 lbs	\$132.99
550991	1123-X "U" bolts, 4-pack	1 lbs	9.99



### JIM BUOY RECTANGULAR HORSESHOE BUOY RACK

Made of 1/4" stainless steel. Holds buoy securely in place. Model 941 holds 940 horseshoe buoy. Model 921 holds 920 and 1020 horseshoe buoys.

Item	Model	Style	Ship	Net
550997	941	Pony	2 lbs	\$25.99
550998	921	Horseshoe	2 lbs	26.99

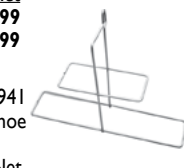

### FORESPAR 300-H HORSESHOE BUOY HOLDER

The electro-polished stainless steel bracket is bent precisely so it will hold a standard horseshoe ring securely without the need of a retaining strap, speeding deployment in case of emergency.

Item	Model	Rail Size	Ship	Net
551524	156001	7/8" - 1"	1 lbs	\$81.99
600906	156021	1-1/4"	1 lbs	86.99



### SEA-DOG RAIL MOUNT HORSESHOE BUOY BRACKET

• Mount: 7/8" or 1" tubing or directly to a flat surface

• Stamped aluminum powder-coated

• Dimensions: 4-1/4" x 4-3/8" x 4"

Item 552565	Model 327135-1	Ship 1 lbs	Net \$29.99
-------------	----------------	------------	-------------



### SEA-DOG RAIL MOUNT RING BUOY BRACKET

• Mount: 7/8" or 1" tubing or directly to a flat surface

• Stamped aluminum, powder-coated

• Dimensions: 3-7/8" x 2"

Item 552566	Model 327130-1	Ship 1 lbs	Net \$17.99
-------------	----------------	------------	-------------



### KENT RING BUOY LINE BAG

• 100 ft. length - 3/8" hollow braid polypropylene rope

• Durable 900D coated polyester bag

• Webbed grab handle

• Adjustable drawcord closure

• Throw line for retrieving buoy only

• NOT FOR LIFTING!

Item	Model	Rope Length	Ship	Net
552732	152500-200-999-17	100'	2 lbs	\$43.99



## Miscellaneous Emergency Items

### ATTWOOD BOATER'S STORAGE BOX

- Keeps your maps, electronics and equipment safe on the water
- The O-ring lid is water-resistant and helps to seal out moisture
- The lift-out tray is great for organizing small items; flip-up lid provides easy access to your stored items
- Flip latch allows you to keep your belongings secure

Item	Model	Color	Size	Ship	Net
550175	11834-1	Safety Orange	15" L x 8" W x 10"	2 lbs	\$17.99



### ATTWOOD TELESCOPING EMERGENCY PADDLE

Easy to store. Its bright Orange color makes it useful for signaling for help. Plastic blade with corrosion-resistant aluminum pole. Telescopes to 42"

Item	Model	Color	Size	Ship	Net
550176	11828-1	Safety Orange	42"L	2 lbs	\$18.99



### BOATMATES SAFETY BAG

Keep your safety and emergency gear organized in this ventilated bag. Holds (4) adult and child PFD's in the main body, plus it has a separate storage area in the lid.

Dimensions: 12" H x 21" W x 15" D.

Item	Model	Description	Ship	Net
552235	3118-6	Yellow	2 lbs	\$35.99



### EDSON 30 GPM PORTABLE EMERGENCY PUMP KIT

- One gallon per stroke
  - 2" Inlet and discharge ports
  - 12' Self-priming suction lift
  - 15' Discharge height
- Mounted on a carry board, the kit comes with 32" stainless steel handle and 20" of 2" flex hose with quick clamp couplings and adapters. Allows you to bring the pump to the problem.

Item 500830	165AL-30-200	Ship 38 lbs	Net \$1028.99
-------------	--------------	-------------	---------------



### WICHARD EMERGENCY BOARDING LADDER

Double layered nylon webbing stitched to withstand 6000 lbs load. Attaches to a life line stanchion, pad eye or cleat. Its glow-in-the-dark loop hangs over the side ready to be grabbed or deployed in seconds. Will not collapse as steps hang from a center strap. Packed in a 1000 denier cordura bag. Manufacturer recommends two ladders, one for each side of boat.

Item	Model	Ship	Net
552023	SP992	1 lbs	\$145.99



### SEA-DOG EMERGENCY BOARDING LADDER

These 5-step, portable emergency boarding ladders are made of molded-in, high-visibility Orange polycarbonate with nylon rope supporting the frame. They secure quickly to cleats, railings, stanchions and halyards and will support up to 300 lbs. Total length open is 5' 6" with 3' 2" of ladder steps and 2' 4" of the hanging loop.

Item 012267	582501-1	Ship 4 lbs	Net \$39.99
-------------	----------	------------	-------------



### SOS MARINE RECOVERY / EMERGENCY RESCUE LADDER

- The Recovery Ladder™ from S.O.S. Marine™ helps a man overboard get out of the water two ways
  - Able crew can climb the integral ladder rungs
  - Lift aboard your injured, disabled or hypothermic crew using your halyard, davit or block and tackle
- Material: Dayglow (Neon Yellow) polyester mesh
- Dimensions fully deployed: 9' W x 7-1/2' H

Item 550893	Ship 8 lbs	Net \$167.99
-------------	------------	--------------

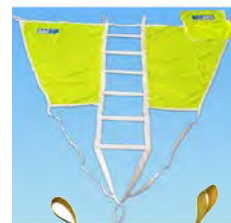

### PLASTIMO 5-STEP EMERGENCY SAFETY LADDER

- Quick launch side mount
- 11.7" between steps
- Includes bag with (2) handles; one handle attaches to the boat, second handle pulls storage bag open and the ladder unfolds instantly

Item 552494	29009	Ship 3 lbs	Net \$124.99
-------------	-------	------------	--------------



### KENT RESCUE THROW BAG

- 3/8" polypropylene floating rope
- 1800 lbs tensile strength
- Durable 600 denier coated polyester with vented mesh construction
- Reflective material for increased visibility
- Elastic glowstick attachment
- Grab strap with buckle
- Adjustable drawcord closure

Item	Model	Rope Length	Ship	Net
550566	152800-300-050-13	50'	2 lbs	\$30.99
550567	152800-300-075-13	75'	3 lbs	42.99
550568	152800-300-100-13	100'	3 lbs	46.99



### STAY AFLOAT EMERGENCY FORM-A-PLUG LEAK SEALANT

- Stops leaks in boats and marine fittings above and below the waterline
- Material: 1-part moldable polymer; hand applied putty

Item	Model	Size	Ship	Net
550523	SA0214	14 oz	1 lbs	\$16.99
550524	SA0328	28 oz	2 lbs	27.99



# MOB Poles & Throwable Rescue Aids

## THROWRAFT THROWABLE TYPE IV INFLATABLE PFD

- Five times smaller than a square cushion when packed
- 9x smaller than the ring buoy (packed)
- Auto-inflates when submerged underwater
- Replaces all square cushions, ring buoys and horseshoe buoys on recreational boats
- High visibility yellow for search and rescue situations
- Easily rearmed and repacked for multiple uses
- Minimum buoyancy: 20 lbs • Dimensions: Packed: 11" x 4", Inflated: 22" x 21"



Item	Model	Description	Ship	Net
ⓐ 550812	TD2401	Throwable inflatable PFD	3 lbs	\$129.95
ⓐ 550875	V86000-84204Z	Re-arm kit	1 lbs	23.99
550928	3303	Throwraft mounting case	4 lbs	84.99

## CREWSAVER RESCUE C.A.S.E. BUOYANCY AID

- Bridges the gap between life jacket and liferaft
- Platform style 6-person buoyancy aid
- Includes (5) 100 lbs ballast pockets, boarding ladder and multiple lifelines
- Raft uses CO2 inflation system
- Packed in high-visibility, lightweight, waterproof valise
- Stowed dimensions: 13" W x 16.5" L x 6.5" D
- 1-Year limited warranty valid with annual service performed by Survitec-approved service station



ⓐ Item 552571	Model 55-00010	Ship 25 lbs	Net \$999.99
---------------	----------------	-------------	--------------

## SWITLIK TECHFLOAT LIFT AND RESCUE DEVICE

- TechFloat Lift and Rescue Device is a throwable, inflatable rescue device for all-season water and ice rescue that has incorporated lifting capability
- Bag dimensions: 13" L x 8" H x 5" W
- Float color: High-Vis Yellow, Case color: Orange/Black
- Includes bag, inflatable horseshoe buoy and 100' of line



Item	Model	Description	Ship	Net
ⓐ 551090	TF-3500-1	TechFloat life and rescue device	5 lbs	\$359.00
ⓐ 551091	S-4121-1	Re-arm kit	1 lbs	30.00

Ships directly from manufacturer.

## SWITLIK MOM 8-S MAN OVERBOARD MODULE

- Consists of underarm flotation device (UFD), inflatable pylon and sea anchor
- UFD provides 35 lbs of inflated buoyancy
- Manual inflation by pulling an easy-to-grab red handle on the valise
- Meets world sailing offshore racing regulation 4.22.1 for Man Overboard lifebuoys
- Self-serviceable with a 1-year service interval
- Soft pack valise dimensions: 11.5" H x 6.5" L x 5.25" W

Item	Model	Description	Ship	Net
ⓐ 551292	S43134-1	MOM 8-S	16 lbs	\$459.00
ⓐ 551293	S4167-1	Re-arm kit	2 lbs	30.00

Ships directly from manufacturer.

## SWITLIK CORD CREW OVERBOARD RESCUE DEVICE

- Designed for man overboard emergencies
- Consists of underarm flotation device (UFD) and 150' of 1/4" High visibility multi-filament polypropylene floating yellow line
- UFD provides 35 lbs of inflated buoyancy
- Manual inflation by pulling the red handle on top • Self-serviceable with a 1-year service interval • Soft pack valise dimensions: 11.5" H x 6.5" L x 5.25" W

Item	Model	Description	Ship	Net
ⓐ 551294	S4161-1	CORD rescue device	8 lbs	\$425.00
ⓐ 551295	S4167-2	Re-arm kit	1 lbs	30.00

Ships directly from manufacturer.

## Jonbuoy Recovery Module - Pushpit Mount

- The Jonbuoy recovery module is designed to make MOB recovery a simple operation while increasing vital visibility and buoyancy
- Accepted as a direct replacement for a traditional Danbuoy, horseshoe, drogue, light and whistle specified within the ISAF offshore special regulations
- Automatic inflation
- Lifting ring
- Retroreflective binding
- Large ballast pocket
- 5 m weighted throwing line
- R10 attachment point
- Dimensions: 9.75" D x 15.25" W x 15.75" L
- Automatic light
- SWL of 200 kg
- Repackable
- Slimline container
- Compact and lightweight
- Weight: 15.5 lbs



Please Specify: White or Black case  
 ⓐ Item 551908 Ship 18 lbs Net \$999.99  
 Ships directly from manufacturer.

## Jonbuoy Danbuoy & Horseshoe Combination

- This combination of Danbuoy and Horseshoe conforms to the ISAF offshore special regulations and is a natural extension of the original inflatable Jonbuoy Danbuoy
- In the event of a man overboard, simply unclip the unit from its mounting bracket and throw into the water; it then automatically inflates
- Meets requirements of ISAF offshore regulations
- High impact casing
- Inflatable Danbuoy
- Drogue
- Danbuoy light
- Highly visible
- Rail mounting cradle
- Inflatable horseshoe
- Whistle
- Quick and easy to use
- Lightweight



Please Specify: White or Black case  
 ⓐ Item 551909 Ship 10 lbs Net \$399.99  
 Ships directly from manufacturer.

## Jonbuoy Inflatable Danbuoy with Light

- The inflatable Jonbuoy Danbuoy is stylish, compact and weighs only 3.3 kgs
- It can be mounted on the pushpit and is easily deployed in an emergency
- In the event of a man overboard, simply unclip the unit from its mounting bracket and throw into the water where it will automatically inflate
- It replaces the traditional Danbuoy, light, drogue and whistle
- Meets requirements of ISAF offshore regulations
- Compact
- Highly visible
- Lightweight
- Automatic inflation 33 g cylinder
- Quick and easy to use
- Easily repacked
- Automatic light



Please Specify: White or Black case  
 ⓐ Item 551910 Ship 9 lbs Net \$299.99  
 Ships directly from manufacturer.

## FORESPAR MAN OVERBOARD POLE

- Bright Yellow, fiberglass, high impact, foam-filled float (2 piece units)
- Dacron Red/Yellow flag- float is Orange and slotted to fit backstay

## ACCESSORIES FOR MOB

Item	Model	Description	LOA	Net
551019	202018	OP-120/150 Standard	138" - 180"	\$219.99
Item	Model	Description	Ship	Net
551980	202026	Replacement flag for OP-120/150	1 lbs	\$42.99
551021	202013	OP-FT Polyvinyl flag tube with fasteners and instructions	2 lbs	40.99
551022	156003	300M Pole holder for 1" rail*	1 lbs	82.99

\* Holds the base of the pole and easily mounts to the stern rail.

## PLASTIMO INFLATABLE IOR DAN BUOY

- Applications: man overboard (MOB) flotation and visibility
- Includes ABS plastic canister (Height 49 cm x 13 cm)
- Rigid ballast with V-shaped batten structure
- Includes: Sling seat, grab handle, Red and Yellow flag, drogue anchor
- Provides 150 N buoyancy • Comes with SOLAS light
- SAF-OR compliant • Buoy Color: Hi-Vis Yellow

Item	Model	Description	Ship	Net
ⓐ 552727	61073/63455	Inflatable IOR Dan Buoy Please Specify White or Yellow Canister	9 lbs	\$299.99
ⓐ 550585	50374	IOR re-arm kit; (1) 60 gram Co2 cylinder; (1) locking clips	1 lbs	35.99
550807	415010	IOR or MOB rail mounting kit (requires 2)	1 lbs	4.99

## PLASTIMO INFLATABLE PERSONAL DAN BUOY

- The Plastimo Danbuoy is Neon Yellow nylon, polyurethane coated
- Manual activation: In the event of a man overboard, the victim activates the inflation by pulling the toggle
- Height above water when inflated: 1.80 m
- Includes: Red and yellow flag (21 cm x 14 cm), retro-reflective tapes, lanyard, oral inflation tube and PVC pouch with belt attachment (for attaching to foul weather gear or lifejacket)
- Dimensions (in pouch): 11 cm x 14 cm x 7 cm



ⓐ Item 552725 Model 53482 Ship 1 lbs Net \$99.99

## PLASTIMO RESCUE SLING

- Delivers flotation to a victim and provides a means to hoist the person aboard (with use of a lifting tackle or halyard winch if necessary).
- 131' floating retrieval line is coiled on a reel.

Item	Description	Ship	Net
552199	Specify Yellow or White bag	4 lbs	Starting At \$149.99
552424	65.5' Yellow rescue line	2 lbs	62.99
552425	Rescue line rail mount basket	1 lbs	19.99

## REELSLING™ MAN OVERBOARD (MOB) RECOVERY DEVICE

- Buoyancy: 21 lbs • Stainless steel D rings
- Includes light, reflective tape, grab handle and whistle

Item	Model	Dimensions	Ship	Net
550695	RS100	19" x 14" x 7"	6 lbs	\$174.99





Revere Survival Inc. offers a line of extremely durable and rugged liferafts at affordable prices. These liferafts are the answer for the safety conscious boater on a budget.

**Coastal Compact**

Bridges the gap between the life jacket and a full feature liferaft, offering those traveling alone the smallest, lightest and most inexpensive raft available.

- With (2) 200 lbs SuperRev™ ballast pockets and a sea anchor, the Coastal Compact enhances stability in rough sea conditions
- Its light weight allows for easy deployment
- Compact size makes stowage easy in the smallest spaces
- Just open the red flap on the valise, extend the painter line, give a hard pull and the raft inflates automatically (in less than 30 seconds)
- Not recommended for offshore use

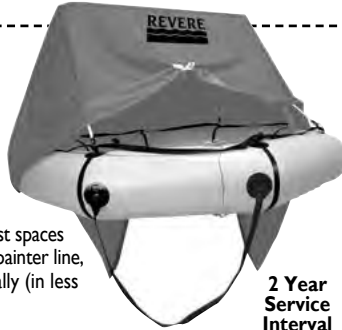

**2 Year Service Interval**

Packed Dimensions (L x W x H)

Item	Model	Description	Packed Dimensions (L x W x H)	Ship	Net
▲ 551900	45-CC2V	2 Person valise	19.5" x 10" x 5"	18 lbs	\$971.99
▲ 551901	45-CC4V	4 Person valise	16.5" x 13" x 5"	19 lbs	1186.99
▲ 454652	45-CC4VP	4 Person valise w/canopy	16.5" x 13" x 6"	22 lbs	1219.99
▲ 454653	45-CC6V	6 Person valise	20" x 13" x 7"	24 lbs	1399.99
▲ 454654	45-CC6VP	6 Person valise w/canopy	20" x 14" x 7.5"	27 lbs	1509.99

**Coastal Commander™ 2.0**

The Coastal Commander is Revere Survival Inc.'s answer to economy, durability and safety – requiring service just once every three years! It is fitted at each corner with lead weighted, deep water ballast pockets to improve stability in rough sea conditions.

- Rugged, oversize double tubes
- Boarding ladder, righting strap, ballast bags with fast deploying weights, safety lifelines
- Vacuum-packed for protection against the environment and to minimize service costs
- Rescue quoit, unwinding unit and floating knife attached to raft
- Self-erecting canopy with a weatherproof, double-zippered door and rainwater collector
- Sea anchor with 100 ft. (30 m) tow line
- Pressure relief valves
- Visit us at [www.defender.com](http://www.defender.com) for complete equipment pack contents



**3 Year Service Interval**

Item	Model	Description	Packed Dimensions (L x W x H)	Ship	Net
▲ 550613	45-COASTCO2-6V	6 Person valise	27" x 10.5" x 17.5"	65 lbs	\$1599.99
▲ 550614	45-COASTCO2-6C	6 Person canister	30.5" x 21.5" x 13.5"	78 lbs	1669.99
▲ 550826	45-OO4CRAD	Aluminum cradle with hydro kit for CC 6 person container liferafts		12 lbs	463.99

Liferafts ship ground only, directly from the manufacturer. A flat rate shipping charge will be added to your order at the time of invoicing. All liferafts are subject to manufacturer's return policies, and, in most cases, a restock fee of at least 20% will apply. Freight is not refundable. Please contact us at 800-628-8225 or email us at [orders@defender.com](mailto:orders@defender.com) for current rates and/or more information.

**Offshore Commander™ 2.0**

The Offshore Commander provides the same durable quality as the Coastal Commander, yet is suitable for offshore boating. It's the latest in affordable, offshore liferafts by Revere. You WILL be safe at sea!

- Foam insulated floor for cold water
- Self-erecting canopy with a weatherproof, double zippered door and rear rain collector
- Canopy light and reflective tape
- Rugged, oversized double tubes
- Boarding ladder, righting strap, ballast bags with fast deploying weights and safety lifelines
- Vacuum-packed for protection against the environment and to minimize service costs
- Service required only once every 3 years
- Floating knife attached to raft
- Sea anchor with 100' (30 m) tow line
- Pressure relief valves



**3 Year Service Interval**

**12 YEAR WARRANTY!**

Item	Model	Description	Packed Dimensions (L x W x H)	Ship	Net
▲ 550615	45-OC2-4V	4 Person - valise	26" x 9" x 18"	67 lbs	\$1719.99
▲ 550616	45-OC2-4C	4 Person - canister	30.5" x 21.5" x 13.5"	80 lbs	1929.99
▲ 550617	45-OC2-6V	6 Person - valise	30" x 11" x 18"	74 lbs	2029.99
▲ 550618	45-OC2-6C	6 Person - canister	30.5" x 21.5" x 13.5"	86 lbs	2129.99
▲ 550619	45-OC2-8V	8 Person - valise	32" x 12" x 21"	92 lbs	2159.99
▲ 550620	45-OC2-8C	8 Person - canister	32.5" x 23" x 14"	103 lbs	2469.99
▲ 550826	45-OO4CRAD	Aluminum cradle with Hydro kit for OC 4 or 6 person canister liferafts		12 lbs	463.99
▲ 550827	45-OO8CRAD	Aluminum cradle with Hydro kit for OC 8 person canister liferafts		12 lbs	463.99

**Offshore Elite**

- The lightest raft in its class starting at just 54 lbs!
- (2) large independent buoyancy chambers each over 11" round
- Automatically inflated canopy, boarding ramp (not a ladder) which makes it easier to enter the raft in rough sea conditions
- Inflatable floor, stowage pockets, zippered windows, flashing strobe, extra large ballast pockets, extensive equipment pack including USCG/SOLAS flares plus more
- Vacuum packed to add greater protection and minimize servicing costs (if serviced according to manufacturer's specs, it offers a 12 year warranty)
- Visit us at [www.defender.com](http://www.defender.com) for complete equipment pack contents



**3 Year Service Interval**

**12 YEAR WARRANTY!**

Item	Model	Description	Packed Dimensions (L x W x H)	Ship	Net
▲ 453619	45-OE4V	4 Person - valise	28" x 19" x 12"	59 lbs	\$3729.99
▲ 453620	45-OE4C	4 Person - canister	31.5" x 22" x 12.5"	76 lbs	3949.99
▲ 453621	45-OE6V	6 Person - valise	30" x 17" x 13"	68 lbs	3949.99
▲ 453622	45-OE6C	6 Person - canister	34" x 25" x 13"	87 lbs	4149.99
▲ 453623	45-OE8V	8 Person - valise	36.5" x 19" x 11"	77 lbs	4149.99
▲ 453624	45-OE8C	8 Person - canister	34" x 25" x 13"	94 lbs	4349.99
▲ 550824	45-OE4CRAD	Powder coated aluminum cradle and Hydro kit for OE 4, 6 or 8 Person canister liferafts		10 lbs	463.99
▲ 550825	45-OE6CRAD	Powder coated aluminum cradle and Hydro kit for OE 6 or 8 Person canister liferafts		10 lbs	463.99

**Emergency Supplies**

**ACR RAPIDDITCH BAG**

Shoulder strap unhooks and separates into two safety straps that clip to life jackets to keep everyone together in the water.

- Buoyant closed cell foam with coated polyester exterior
- Clear document holder, exterior pockets, side pouch and secure EPIRB holder
- (12) built-in flare holders and (3) interior organizing pockets
- Tethers - (4) (Model 2778); (2) (Model 2779)
- Color: ACRtreuse™ • One year factory warranty



Item	Model	Size W x H x D	Gallons	Ship	Net
550535	2278	29" x 10" x 14.5"	18.2	4 lbs	\$93.99
550536	2279	21" x 6" x 14.5"	7.9	2 lbs	56.99

**PLASTIMO SURVIVAL SLEEPING BAG**

- Material: Polyethylene, Color: Hi-Vis Orange
- Size: 6.6' x 3.2' plus hood
- Accommodates Adults to 6-1/2' tall



Item	Model	Ship	Net
552426	22785	1 lbs	\$31.99

**SOL SURVIVAL/EMERGENCY BLANKET** All ship 1 lbs

- Reflects 90% of your body heat • Tear resistant polyethylene



Item	Model	Description	Size	Net
552422	0140-1222	One person	56" x 84"	\$3.99
552421	0140-1701	Two person	58" x 98"	4.99

**SURVITEC EMERGENCY PURIFIED DRINKING WATER**

- Air and light-tight for maximum freshness and storage
- Pouches are sold individually
- Storage life: up to 5 years

Item	Model	Description	Ship	Net
551286	10-REV022W	4.2 oz. Individual use pouch	1 lbs	\$0.69



**DATREX EMERGENCY FOOD BAR RATIONS**

- 200 calories per bar– high energy value and ready to eat
- Individually wrapped bars • 5 year shelf life
- All natural ingredients • Tableted and subpackaged

Item	Model	Description	Ship	Net
550702	DX2400F	2,400 Total calories/12 bars	1 lbs	\$5.99
550703	DX3600F	3,600 Total calories/18 bars	2 lbs	8.99



**DATREX AQUAMATE SOLAR STILL DESALINATOR**

- Produces approximately 2 to 8 cups of drinking water per day\*
- Pack dims: 10" x 9" x 3"; Inflated: 29" D x 24" H
- A fraction of the cost of a mechanical or electrical unit

Item	Model	Ship	Net
550469	EMAMSSM	3 lbs	\$249.99



\*Depending on weather and water type

**PLASTIMO FLOATING SAFETY KNIFE**

- Stainless steel blade with buoyant plastic handle
- Blade length: 2.7", Closed length: 4.5"



Item	Model	Description	Ship	Net
550545	11053	Folding serrated blade with blunt tip	1 lbs	\$23.99

**Fixed Horns**



S-0A



D-0A

**KAHLENBERG MARINE AIR HORNS USCG COLREGS COMPLIANT**

The monotone model D-0A, and chime tone S-0A air horns are certified to international requirements (IMO COLREGS) for boats up to 65 feet in length. Made entirely of brass and bronze Single: 15.92"L. Dual: 21.58"L.

Item	Model/Description	Ship	Net
551122	S-0A Brass Single, polished brass	6 lbs	\$259.99
	S-0A White Single, White powder	6 lbs	287.99
	S-0A Chrome Single, chrome plate	6 lbs	307.90
551123	D-0A Brass Dual, polished brass	12 lbs	444.99
	D-0A White Dual, White powder	12 lbs	599.99
	D-0A Chrome Dual, chrome plate	12 lbs	627.99
550904	P449-17 12 Volt DC compressor kit (Includes air tank, pressure switch, hose and fittings)	16 lbs	433.99
551018	V-69K 12V electrical solenoid	1 lbs	59.99
	V-69K 24V electrical solenoid	1 lbs	59.99

**ONGARO STANDARD HORNS**

304 Stainless steel housing, diaphragm and mounting brackets. 12 Volt DC. Meets ABYC specifications for boats up to 39". Pre-wired and marked positive or negative.

Item	Model	Description	Ship	Net
550892	10035	Mini single	1 lbs	\$29.99
551888	10001	Mini twin	2 lbs	56.99

**ONGARO 100% STAINLESS STEEL HORNS**

All are stainless steel inside and out including sealed sound unit. All horns are 304 stainless steel assembled and pre-wired. Dual trumpet (#10028) meets ABYC A-23 specs for boats up to 65". All other horns are approved by ABYC for boats up to 39".

Item	Model	Description	Ship	Net
551997	10036	Mini single	1 lbs	\$37.99
551998	10002	Mini twin	2 lbs	69.99
551999	11032	Mini hidden compact single	1 lbs	34.99
551927	10027*	Deluxe single trumpet	2 lbs	84.99
551928	10028*	Deluxe dual trumpet	4 lbs	139.99
552131	10050	Mini drop-in single	1 lbs	36.99
552132	10055	Mini drop-in dual	2 lbs	69.99

\*Deluxe horns are waterproof and feature a drain hole

**FIAMM FULTONE PNEUMATIC DUAL MARINE HORN KIT WITH AIR COMPRESSOR**

- Includes (2) 114 dB (High=300 Hz/Low=260 Hz), hose and switch
  - Materials: 304 Stainless steel and painted aluminum
- | Item   | Model | Horn | Volts      | Draw | Ship  | Net      |
|--------|-------|------|------------|------|-------|----------|
| 550700 | 62330 | Dual | 12 Volt DC | 20 A | 6 lbs | \$169.99 |
|        | 62340 | Dual | 24 Volt DC | 10 A | 6 lbs | 169.99   |

**FIAMM TORONADO PNEUMATIC MARINE HORN KIT WITH AIR COMPRESSOR**

- Includes (1) 120 dB (320 Hz), hose and switch
  - Materials: 304 Stainless steel and chrome plated brass
- | Item   | Model    | Horn   | Volts      | Draw | Ship  | Net      |
|--------|----------|--------|------------|------|-------|----------|
| 550501 | 63210-14 | Single | 12 Volt DC | 20 A | 4 lbs | \$149.99 |
- Includes (2) 122 dB (High=380 Hz/Low=320 Hz), hose and switch
  - Materials: 304 Stainless steel and chrome plated brass
- | Item   | Model | Horn | Volts      | Draw | Ship  | Net      |
|--------|-------|------|------------|------|-------|----------|
| 550701 | 63230 | Dual | 12 Volt DC | 20 A | 6 lbs | \$239.99 |
|        | 63330 | Dual | 24 Volt DC | 10 A | 6 lbs | 239.99   |

**Bells**

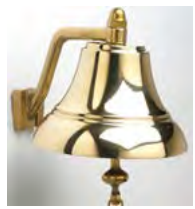

**WEEMS & PLATH BRASS BELL**

- Material: Cast brass, polished to a mirror finish
- Produces a rich tone when struck
- Includes lifetime warranty

Item	Model	Dimensions*	Ship	M.A.P.
402531	6000	5-1/4" H x 6" Dia.	3 lbs	\$109.99
402533	7000	6" H x 7" Dia.	4 lbs	149.99
402535	8000	8" H x 8-1/2" Dia.	5 lbs	345.99
402537	12000	11" H x 12-3/8" Dia.	19 lbs	699.99

\*Dimensions when mounted



**SHIPS FOG BELL**

All mounting hardware is included. 8" styles meet USCG, ABYC and NMMA requirements with a minimum of 200 cm mouth opening and striker mass no less than 3% of the bell mass.

Item	Model	Description	Size	Ship	Net
551589	455000	Brass	6"	2 lbs	\$45.99
550923	455001	Chrome plated	6"	2 lbs	49.99
550922	455720	Brass	8"	4 lbs	72.99
551588	455721	Chrome plated	8"	4 lbs	83.99
552146	S-812	Brass	12"	5 lbs	171.99
552147	S-813	Chrome plated	12"	5 lbs	189.99

**Handheld Horns**



**SEACHOICE PUMP BLAST MANUAL AIR HORN**

- Meets USCG requirements for boats up to 65'
- Eco-friendly; requires no replacement cans or chemicals
- Not just for boating - Use at sporting events or for your auto

Item	Model	Decibels	Ship	Net
550338	SCP 46311	110	1 lbs	\$12.99



**FALCON SONIC BLAST 5 OZ. HORN**

- Available with durable plastic trumpet or all metal horn
- Provides up to 56 blasts per can
- Meets USCG requirements for boats up to 65'
- Provides 120 dB blasts at 10 ft

Please Specify: White plastic or chrome metal horn

Item	Model	Ship	Net
ⓐ 550876	FSB5 White plastic	2 lbs	\$20.99
ⓐ 550877	FSB5C Chrome metal	2 lbs	42.99
ⓐ 550877	FSB5R 5 oz. refill	1 lbs	16.99



**FALCON SOUND ALERT 6 OZ. HORN**

- Easy to ship with no hazardous shipping fees or paperwork required
- Provides up to 80 blasts per can
- Meets USCG requirements for boats up to 65'
- Provides 120 dB blasts at 10 ft

Item	Model	Ship	Net
ⓐ 550878	FSA6	2 lbs	\$15.99
ⓐ 550879	FSA6R 6 oz. refill	1 lbs	9.99



**FALCON SIGNAL HORN 1 OZ. HORN**

- Provides up to 12 blasts per can
- Meets USCG requirements for boats up to 39'
- Provides 112 dB blasts at 10 ft

Item	Model	Ship	Net
ⓐ 550880	FSH1	1 lbs	\$9.99



**5.5 OZ. HORN**

- Provides up to 62 blasts per can
- Meets USCG requirements for boats up to 65'
- Provides 120 dB blasts at 10 ft

Item	Model	Ship	Net
ⓐ 550881	FSH	1 lbs	\$10.99
ⓐ 550882	FSHR 5.5 oz. refill	1 lbs	4.99

**INNOVATIVE LIGHTING HAND HELD ELECTRONIC HORN**

Contains no CFC's, no HAZMAT, no leaking or limited shelf life.

- Weatherproof, solid state electronics
- Meets USCG requirements
- Shock resistant construction
- (1) 9 Volt DC battery required (not Included)

Item	Model	Size	Ship	Net
700824	545-2010-7	6.45" x 3.40"	1 lbs	\$28.99

 **LIKE US ON FACEBOOK**  
[FACEBOOK.COM/DEFENDERINDUSTRIES](https://www.facebook.com/DEFENDERINDUSTRIES)

**Manual Horns**



**SEA-DOG MANUAL AIR HORN**

- Injection molded ABS plastic

Item	Model	Size	Ship	Net
550486	572025-1	7-7/8"	1 lbs	\$10.99



**SEA-DOG MANUAL AIR HORN**

- Stamped 304 stainless steel
- Includes 13" lanyard
- Mouth piece can be removed for cleaning

Item	Model	Size	Ship	Net
550485	572050-1	7-7/16"	1 lbs	\$29.99

ⓐ Ships Ground Only - No Extra Charge  
 🚚 Ships by Truck  
 ⓓ Larger Size Product, Ships at Dimensional Weight  
 ⚠️ Hazardous Material. \$35.00 Fee & Ships Ground Only



**Marine Series**

All kits in this series have considered:

- Treatment of common on-board traumatic injuries
- Medical expertise of the crew
- All kits include the essential "A Comprehensive Guide to Marine Medicine"
- Treatment of common ailments at sea. e.g., sunburn, skin infections, and seasickness
- The number of crew and duration of trip
- Water-resistant zipper seals moisture out

**\*Pertaining to Marine 3000, Marine 2000 and Marine 1000**

Kit contents exceed the USCG minimum requirements for: Small Commercial Passenger Vessels in 46 CFR 121.710 and 184.710; Life Boats in CFR Subchapter Q 160.041; Life Rafts in Sec. 160.054, 1-21; Commercial Vessels in Sec. 121.710; Large Commercial Fishing and Non-Fishing Vessels - governed by the United States Public Health Service; Mobile Offshore Drilling Units in Requirement: 46 CFR subchapter 1-A. Our goal is to provide you with high quality medical supplies that are modern and up-to-date, to increase your self-reliance at sea.

Visit [www.defender.com](http://www.defender.com) for more information.

\*Kit contents meets CG regulations for small commercial passenger and fishing vessels. (46CFR184.710) and (46CFR28.210).



**\*MARINE 3000- For use in offshore waters.**  
Upgrades from 2000 include nasal airways, a single use disposal bag, disposable enema bag, glucose paste, hydrogel dressing and larger quantities of medications, dressings and wound care items.  
• **Crew Size:** 1-18 people • **Voyage Type:** over 24 hrs from medical care • **Size:** 24" x 14" x 6.5" • **Weight:** 15 lbs 20 oz.  
Item **552310** 0115-3000 Ship 17 lbs **Net \$794.99**



PRACTICAL SAILOR'S  
"BEST GEAR OF THE YEAR"

**\*MARINE 2000- For use at sea, or in a remote location.**  
Upgrades from the 1000 include: dental supplies, suture syringe supplies, skin stapler, blood pressure cuff and stethoscope, Foley catheter, larger quantities of medications and wound care supplies.  
• **Crew Size:** 1-12 People • **Voyage Type:** 12-24 hrs from medical care • **Size:** 22" x 12" x 5.5" • **Weight:** 12 lbs 4 oz.  
Item **552311** 0115-2000 Ship 14 lbs **Net \$594.99**



**\*MARINE 1000- For use while coastal cruising.**  
Contains CPR supplies, advanced care instruments, wound care, burns/blister, fractures/sprains, bleeding, and medications modules.  
• **Crew Size:** 1-5 People • **Voyage Type:** 12-24 hrs from medical care • **Size:** 15" x 10" x 5.5" • **Weight:** 6 lbs 2 oz.  
Item **552312** 0115-1000 Ship 14 lbs **Net \$299.99**



**MARINE 600**  
Key features include easy reference injury cards, waterproof pockets for medications, supplies to treat basic and advanced illnesses and trauma, a Comprehensive Guide to Marine Medicine, numerous bandages and dressings. All this is enclosed in a durable and waterproof, floating dry box case.  
• **Voyage Type:** 12-24 hrs from medical care • **Crew Size:** 1-8 people • **Vessel Type:** • Recreational, fishing, runabout, PWC  
• **Size:** 11.8" x 10.6" x 6.9" • **Weight:** 7 lbs 4 oz.  
Item **552524** 0115-0600 Ship 8 lbs **Net \$199.99**



**\*MARINE 400- For near shore, salt/freshwater boating.**  
Major upgrades from 300 include: Laerdal® CPR face shield, triangular bandage, sterile eye wash, as well as larger quantities of medications and wound care items.  
• **Voyage Type:** under 6 hrs from medical care • **Crew Size:** 1-6 people • **Vessel Type:** Recreational, offshore/coastal, Commercial • **Size:** 8.5" x 6.5" x 5" • **Weight:** 2 lbs 3 oz.  
Item **552314** 0115-0400 Ship 3 lbs **Net \$99.99**



**MARINE 300-For near shore, salt/freshwater boating.**  
Major upgrades from the Marine 200 include: two person emergency reflective blanket, advanced wound cleaning system with irrigation syringe, wound closure strips and iodine, AfterBite wipes, bandage scissors, additional wound care items and medications.  
• **Voyage Type:** Inland waters, 1-2 hrs from medical care • **Crew Size:** 1-6 people • **Vessel Type:** Fishing, recreational, day trips  
• **Size:** 8.25" x 5.5" x 4.5" • **Weight:** 1 lbs 14 oz.  
Item **552315** 0115-0300 Ship 2 lbs **Net \$49.99**



**MARINE 200**  
Major upgrades from Marine 100 include a Comprehensive Guide to Wilderness, Marine, and Travel Medicine, trauma pads, moleskin, elastic bandage, instant ice pack, acetaminophen, aspirin, meclizine, aloe vera gel and folding scissors. **Voyage Type:** Inland waters, lakes and rivers • **Crew Size:** 1-6 people • **Vessel Type:** Fishing, recreational, day sailors, runabouts • **Size:** 7.5" x 5.5" x 3.5" • **Weight:** 1 lbs 4 oz.  
Item **552316** 0115-0200 Ship 2 lbs **Net \$34.99**



**MARINE MEDICINE - A COMPREHENSIVE GUIDE, 2ND EDITION**  
Authors Eric Weiss & Michael Jacobs  
• The latest information on marine first aid  
• Advice for sailing, pleasure boating, fishing, and diving emergencies  
• 333 paperback pages with more than 100 illustrations  
• As vital a piece of gear as your PFD and signal flares  
Item **050194** 978-1594856600 Ship 1 lbs **Net \$14.99**

SEE A COMPLETE LIST OF ALL KIT CONTENTS AT DEFENDER.COM.

**UST Featherlite™ First Aid Kits**



**FEATHERLITE™ FIRST AID KITS**

Contains an assortment of first aid supplies needed to treat a variety of minor injuries. The outer case is constructed of durable, lightweight nylon cloth that is bright Red to make it easy to locate. A detailed First Aid Kit Owner's Guide is also included with basic first aid instructions.

FeatherLite 1.0 60 Pieces  
FeatherLite 2.0 125 Pieces  
FeatherLite 3.0 205 Pieces

	1.0	2.0	3.0
Acetaminophen	2	4	6
Alcohol prep pads		12	21
Antibiotic ointment packets	2	3	2
Antiseptic towelettes	12	18	24
Aspirin tablets	2	4	6
Bandage, adhesive 1" x 3"	5	8	12
Bandage, adhesive 0.75" x 3"	10	15	40
Bandage, adhesive 0.4" x 1.5"	15	15	30
Bandage, knuckle		2	2
Burn cream packets	2	3	2
Butterfly closures	5	5	10
Cold pack		1	1
Cotton tip applicators		10	10
2" bandage, elastic w/clips		1	1
Electrolyte tablets		2	6
Examination gloves (one each)		2	2
Finger splints		2	5
First aid guide		1	1
Sterile gauze pads, 2" x 2"		5	10
Sterile gauze pads, 4" x 4"		2	4
Sterile gauze trauma pad, 9" x 5"		1	1
Moleskin, 2" x 3"	2	2	2
Safety pins		2	2
Sting relief pads	3	3	3
Waterproof tape, 2.5 yards		1	1
Plastic tweezers, disposable		1	1

Item	Model	Dimensions	Ship	Net
550869	80-30-1450	FeatherLite 1.0 5.5" H x 5.5" W x 1" D	1 lbs	\$10.99
550870	80-30-1455	FeatherLite 2.0 5" H x 8" W x 2" D	1 lbs	15.99
550871	80-30-1460	FeatherLite 3.0 5.5" H x 9" W x 2.5" D	1 lbs	20.99



Some manufacturers set M.A.P. (Minimum Advertised Pricing) for their products, so we cannot advertise a lower price. However, this does not always apply to selling price. The actual price you will be charged is probably lower. Please call us at 800-628-8225 for further details.

**ORION**

**Orion First Aid Kits**



**COASTAL FIRST AID KIT**

Packed in double zipper (soft side case), PVC coated nylon bags with room to add additional products. Comes with 3 modular components (general first aid - 58 items, small wounds - 13 items, and small sprain - 4 items), plus premium fabric bandages. Easy to read emergency instructions. Perfect for any size boat. 75 pieces total. Kit Size: 8" x 4" x 6.25".  
Item **552111** Model **840** Ship 1 lbs **Net \$29.99**



**BLUE WATER FIRST AID KIT**

Packed in double zipper (soft side case), PVC coated nylon bags with room to add additional products. Provides protection for medical situations until you return to shore. Comes with 5 modular components (general first aid - 58 items, small wounds - 13 items, small sprain - 4 items, eye injury - 4 items and medications - 67 items). 146 pieces total. Kit Size: 18" x 14" x 7".  
Item **552112** Model **841** Ship 2 lbs **Net \$56.99**



**OFFSHORE SPORTSFISHER KIT**

The product assortment in this kit will answer your primary, first aid medical emergency needs. The Sportsfisher provides many different first aid products (30 items/165 total pieces), all packed in a wall mountable, impact resistant case (hard) with a weatherproof gasketed lid. Kit size: 19" x 10.25" x 10.75".  
Item **550149** Model **844** Ship 3 lbs **Net \$54.99**

## Radar Reflectors

### Datrex Echomax Radar Reflectors

- Provides stronger and more consistent targets on radar and from farther away, helping to prevent collisions and close calls
- Patented symmetrical stacked array ensures that there is always a fully open corner facing the horizon, which greatly increases your chance of being picked up by interrogating radar
- Movement in real sea conditions excites the response
- Increased center band response over a 360° horizon, high returns to X and S band radar and increased response when heeling



#### EM12 PASSIVE BALL RADAR REFLECTOR

- Designed for emergency or liferaft use
- Supplied as a flat pack with a handled bag
- The RORC recommend a mounting height of 4 meters (13') above sea level, or, on small craft, as high as possible
- Mounting heights of 10' to 35' will give an approximate radar response between 4-7 nautical miles

Item	Model	Dimensions	RCS	Ship	Net
550697	EM0012M	12" L x 12" H	*Meters <sup>2</sup>	1 lbs	\$59.99
		0.25" (folded)			

\* The catch rain position gives a maximum RCS of 5.57m<sup>2</sup> and an average RCS of 1.77m<sup>2</sup>. The double catch rain position gives a maximum RCS of 43.57m<sup>2</sup> and an average of 3.91m<sup>2</sup>



#### EM230I INFLATABLE PASSIVE RADAR REFLECTOR

- Based on a patented stacked symmetrical array
- Can be halyard suspended or strapped to any vertical surface

Item	Model	Dimensions	RCS	Ship	Net
550470	EM230I	29" L x 11.8" W	25.6 Meters <sup>2</sup>	2 lbs	\$209.99
550471	EMA031FXKM	Carbon rod mounting kit		1 lbs	67.99

#### EM230BR RIGID STANDARD PASSIVE RADAR REFLECTOR

- Suitable for 30' plus sailing and motor vessels • Halyard suspended, deck or mast mounted
- Manufactured under tight tolerance controls of +/- 10 degrees for maximum return

Item	Model	Dimensions	RCS	Ship	Net
550473	EM230BR	24" L x 9.65" Dia.	24 Meters <sup>2</sup>	7 lbs	\$259.99
550479	EM230MBM	Mounting bracket, pair		1 lbs	99.99

## Sea Anchors

#### PARA-TECH PARACHUTE SEA ANCHOR

Used off the bow to hold your boat, a sea anchor is the first defense in heavy weather. Prevents broaching or capsizing; provides drift control and stabilization to make repairs. Packed in deployable stowage bag; includes float line, shackle and instruction manual. Does not include rode, swivel, trip line or floats. Visit [www.seanchor.com](http://www.seanchor.com) for more info.

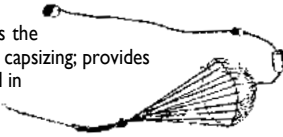

Item	Boat Size	Dia.	Ship	Net	Boat Size	Dia.	Ship	Net
551344	to 20'	6"	5 lbs	\$229.99	30'-40'	15"	15 lbs	764.99
	to 25'	9"	7 lbs	304.99	35'-48'	18"	23 lbs	884.99
	25'-33'	12"	12 lbs	534.99	40'-90'	24"	33 lbs	1224.95



#### PARA-TECH DELTA DROGUE

Tow off the stern to keep boat aligned with the seaway. Simple to use, stable, no-foul design; durably built. Comes with swivel, stow bag and instructions.

Item	Boat Size	Drogue	Ship	Net
551345	Up to 25'	36"	2 lbs	\$169.99
	Up to 35'	48"	3 lbs	184.99
	Up to 45'	72"	5 lbs	234.99
	Up to 55'	96"	8 lbs	269.99
	Up to 65'	114"	10 lbs	354.99

#### PARA-TECH TRIP LINES

Recommended for the easiest recovery of your PARA-TECH Sea Anchor. Designed for easy deployment. Packed in a high-visibility Red bag with cushioned bottom and built-in float.

Item	Length	Ship	Net
551346	100'	4 lbs	\$94.99
	150'	4 lbs	109.99
	200'	6 lbs	129.99

## Safety Netting



#### HEAVY DUTY SAFETY NETTING

Constructed of Dupont #36 nylon twine. Uses a conventional knotted web which is 80% stronger than the knotless netting. Manufacturer suggests adding 30% to the actual length to compensate for the difference between stretch length versus hung length.

Item	Model	Breaking Strength	Width	Squares	Ship/ft	Net/yard
551137	130N	320 lbs	24"	2"	1 lbs	\$6.99

#### PLASTIMO SAFETY NETTING

Item	Model	Description	Ship	Net
552504	58091	33 feet	2 lbs	\$69.99



#### C.S. JOHNSON LIFELINE NETTING

- Made from high tenacity Polypropylene (HTPP)
- 2" x 2" square woven mesh

Item	Size	Color	Ship	Net
615354	26" x 10'	White	1 lbs	\$72.99
615355	26" x 20'	White	2 lbs	129.99
615356	26" x 40'	White	4 lbs	249.99



#### EM180 RIGID COMPACT PASSIVE RADAR REFLECTOR

- Suitable for vessels up to 26.2'
- Can be halyard suspended, deck or mast mounted
- Manufactured under tight tolerance controls of +/- 10 degrees for maximum return

Item	Model	Dimensions	RCS	Ship	Net
550472	EM180	19" L x 7.75" Dia.	8 Meters <sup>2</sup>	5 lbs	\$169.99
550478	EM180MBM	Mounting bracket		1 lbs	49.99



#### ACTIVE X BAND RADAR REFLECTOR & ALARM KIT

- Typically used for coastal waters
- ECHOMAX Active-X and XS are approved by the FCC

Item	Model	Antenna H x Dia.	RCS	Ship	Net
550474	EMACTIVE-XM	27" x 1.6"	118.33 M <sup>2</sup>	4 lbs	\$899.99

#### ACTIVE XS BAND RADAR REFLECTOR & ALARM KIT

- Typically used for coastal and offshore waters
- Picks up X and S band radar (RCS: 118.33 Meters<sup>2</sup> X-band, RCS: 15.75 Meters<sup>2</sup> S-band)

Item	Model	H x Dia.	Ship	Net
550475	EMACTIVEXSM	27" x 1.6"	5 lbs	\$1299.99

Item	Description	Ship	Net
550476	Brushed stainless steel active X and XS antenna mast bracket, 13" L x 4" H x 5" W	1 lbs	\$97.99

## Radar Reflectors



#### Davis Echomaster Radar Reflector

- Give ships a chance to see your boat in fog and low visibility
- Ranked one of the world's best radar reflectors and one of the top ten sailing products by Practical Sailor
- Provides 12 sq. meters of radar cross section
- Plates are made of sturdy, stamped 0.05 in. thick aluminum

- Non-anodized marine grade aluminum plates come apart and can be stored flat
- Install around a backstay or make your own hanging bridle
- Can be assembled around a backstay or wire rigging
- Mounting holes in corner latches make sturdy attachment points
- Includes booklet describing installation and proper use

#### Davis Emergency Echomaster-Style Radar Reflector

- Compact, lightweight and economical unit that disassembles and stows flat for storage
- Open to 11.5" diameter (29 cm) and installs in seconds
- Mounts on mast, rigging, spreader, outriggers, etc.
- Its three perpendicular planes reflect radar from all directions
- Fome-Cor® plastic, laminated with heavy duty aluminum foil resists corrosion and peeling

Item 803137	Model 152	Ship 3 lbs	Net \$59.99
-------------	-----------	------------	-------------



#### Plastimo Tube Type Radar Reflectors

Designed to be used high in the rigging of a sailboat or on the highest point of a powerboat. Mount vertically to achieve maximum reflection. Its compact, cylindrical shape offers little wind resistance and is lightweight. When permanently mounted, the reflector is durable and doesn't make noise. The aluminum elements inside are arranged at varying angles to each other and produce a very stable return on other boats' active radar screens. Bigger is better with radar reflectors: The reflection capacity is proportional to the reflector's size.

Item	Model	Reflective Area	Ship	Net
552178	25586 Sail	21.53 ft <sup>2</sup>	2 lbs	\$42.99
552179	39099 Sail	43.06 ft <sup>2</sup>	3 lbs	74.99
552202	25587 Power	21.53 ft <sup>2</sup>	2 lbs	46.99
552203	29496 Power	43.06 ft <sup>2</sup>	3 lbs	82.99

## ATN "Gale Sail"

- The safest and easiest way to hoist a storm jib in storm conditions
- Now manufactured in solid Storm Orange
- Oversized piston hanks PLUS webbed grommets for easier hoisting
- Eliminates the need for a removable headstay
- Eliminates the dangerous job of unfurling, dropping and stowing away the furled working sail
- Hoisted over the furled headsail, prevents accidental unfurling
- US Sailing / ISAF compliant

Item	Model	Size	For Boat Lengths	Ship	Net
612492	30	30 sq. ft.	<27'	9 lbs	\$769.99
612384	60	60 sq. ft.	28-35'	14 lbs	1099.99
☑ 612385	100	100 sq. ft.	36-43'	33 lbs	1399.99
☑ 612386	150	150 sq. ft.	44-52'	34 lbs	1849.99







Item	Model	Description	Net
▲ 552489	572	Coastal Alerter Plus 12-gauge launcher with (6) aerial signals, whistle and mirror in neoprene storage bag that floats	\$70.99
▲ 552486	575	Coastal Alert/Locate 12-gauge launcher, with (4) aerials, hand-held and smoke signal kit in neoprene storage bag that floats	106.99
▲ 552487	546	Coastal Alert/Locate signal kit with accessories and air horn in neoprene storage bag that floats	116.99
▲ 552488	543	Inland hand-held signal kit with accessories and air horn in neoprene storage bag that floats	63.99
▲ 552525	544	Coastal Alert/Locate Plus signaling kit 12-gauge launcher, (4) 12-gauge high performance Red aerial flares (4) hand-held Red signal flares, (2) hand-held Orange smoke flares and storage case	123.99
▲ 550806	866	Alert/Locate replacement signal pack, (3) Red hand-held flares, (3) 12-ga Red high performance aerial flares, (1) Orange smoke signal	64.99
▲ 552366	800	SOLAS Red parachute flare	51.99

Item	Model	Description	Net
▲ 552365	801	SOLAS Orange floating smoke	\$49.99
▲ 550152	802	SOLAS Red hand-held flare	19.99
▲ 550153	803	SOLAS White hand-held flare	19.99
▲ 552280	549	Alert/Locate Plus signal kit with first aid	127.99
▲ 550738	534	Inland Locate kit with accessories	57.99
▲ 550788	865	Red hand-held signal flares, 4-pack	31.99
▲ 552276	539	12-gauge aerial flares, 4-pack	29.99
▲ 552119	956	Orange hand-held smoke signal, 1-pack	25.99
▲ 552369	511	Offshore Alert/Locate signal kit 25 mm	217.99
▲ 552367	589	25 mm Red aerial flare, 4-pack	53.99
▲ 552032	924	Lightsticks, 4-Pk, (1) ea White/Red (2) Green (can ship)	7.99
▲ 552278	584	12-Gauge Alerter basic kit, launcher w/4 aerials	57.99
▲ 552075	958	Handheld Orange smoke signals, (3) pack	55.99
▲ 550498	820	3 to 50 mile commercial vessel signal kit	259.99

FOR A FULL LINE OF ORION PRODUCTS VISIT WWW.DEFENDER.COM OR OUR OUTLET STORE IN WATERFORD, CT (FLARES FOR PICKUP IN OUR OUTLET STORE ONLY)

## Aqualarm

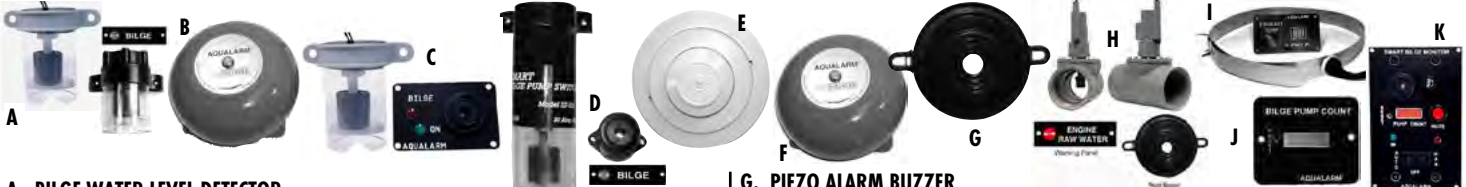

**A. BILGE WATER LEVEL DETECTOR**

- Monitors rising bilge water
- No mercury
- Resists oil, dirt and grease
- Made of rugged ABS and Lexan™
- Not intended to switch a bilge pump on or off

Item	Model	Voltage	Ship	Net
551461	20120	12, 24, 32 VDC	1 lbs	\$37.99

**B. BILGE WATER LEVEL WARNING SYSTEM\***

- Loud bell and Red light panel signal "High Water"
- Not for switching bilge pump on or off
- Includes bell, bilge water level detector and Red light warning panel

Item	Model	Voltage	Ship	Net
550070	20131	12 VDC	2 lbs	79.99

**C. BILGE HIGH WATER ALARM WITH DETECTOR**

- Lights a Red light and sounds alarm when water reaches a predetermined level
- No mercury
- Made of rugged ABS and Lexan
- Resists oil, dirt and grease

Item	Model	Voltage	Ship	Net
552030	20240	12 VDC	1 lbs	59.99

**D. SMART BILGE PUMP SWITCH\***

- Switches pump on and off
- Warns of excessive pumping
- Pumps additional 15 seconds to clear the bilge
- Handles pumps to 20 Amps

Item	Model	Voltage	Ship	Net
550065	20038	12 VDC	1 lbs	\$72.99

**E. AQUALARM REMOTE FIRE DETECTOR**

- Multiple units can be used in parallel
- Ideal for engine room

Item	Model	Voltage	Activates At	Ship	Net
551938	20514	12, 24, 32VDC	194°	1 lbs	\$44.99
551939	20512	12, 24, 32VDC	135°	1 lbs	44.99

**F. STANDARD BELL ALARM\***

- 6" Diameter; loud clanging alarm
- Weatherproof enamel and stainless steel

Item	Model	Voltage	Ship	Net
551917	20100	12 VDC	2 lbs	\$57.99

**G. PIEZO ALARM BUZZER**

- Loud 85 dB
- Flush or surface mount
- Can be used with any detector

Item	Model	Voltage	Ship	Net
550068	20106	12, 24, 32 VDC	1 lbs	\$22.99

**H. SAVE-YOUR-ENGINE KIT**

- Monitors raw water flow
- Sounds alarm and activates Red light if flow stops
- Includes flow detector, 85dB piezo buzzer and Red light panel

Item	Model	Description	Voltage	Ship	Net
550067	20064-LF	1/2" - 3/4" hose size	12 VDC	1 lbs	\$86.99
552022	20064	1" - 1-1/4" hose size	12 VDC	1 lbs	86.99
552048	20062	1-1/2" hose size	12 VDC	2 lbs	89.99
550066	20063	2" hose size	12 VDC	2 lbs	89.99

**I. EXHAUST OVERHEAT ALARM\***

- Activates panel and buzzer if temp exceeds 200°F
- Aluminum band fits 2" - 8" exhaust
- Green power ON light and Red WARNING light
- 5' of marine grade tinned wire

Item	Model	Description	Voltage	Ship	Net
550071	20245	Detector and panel	12 VDC	1 lbs	\$56.99
550072	20248	(2) Detectors and panel	12 VDC	1 lbs	88.99

**J. BILGE PUMP CYCLE COUNTER**

- Electronically counts number of times bilge pump switches on
- LED digital readout with "RESET" (Retains count until reset, even when power is off)
- Can be used with all types of water and bilge pumps

Item	Model	Voltage	Ship	Net
501347	20045	12, 24 and 32 VDC	1 lbs	\$57.99

**K. SMART BILGE MONITOR**

- Alerts to excessive pumping by activating Red light and loud buzzer
- Built-in bilge pump counter counts number of pump cycles

Item	Model	Voltage	Ship	Net
501531	20343	12 VDC	1 lbs	\$124.99

\*24 VDC or 32 VDC available by Special Order.  
Call Defender at (800) 628-8225 for pricing and availability.

# FIREBOY® - XINTEX® Fire Extinguishing Systems & Accessories

## FIREBOY AUTOMATIC DISCHARGE FIRE EXTINGUISHING SYSTEMS

- Contains HFC-227ea - Effective halon replacement Clean Agent chemical
- FireBoy fire extinguishing systems are total flooding systems
- Automatic discharge at 175°F (79°C)
- No water or powdery residue



WARNING: Diesel-powered craft require installation of an Engine Shutdown system.

Item	Model	Max Volume Protected	Ship	Net
▲ 551339	CG20050227-B	050 Cu. ft.	8 lbs	\$189.99
▲ 551310	CG20075227-B	075 Cu. ft.	11 lbs	239.99
▲ 551311	CG20125227-B	125 Cu. ft.	14 lbs	319.99
▲ 551340	CG20175227-B	175 Cu. ft.	19 lbs	419.99
▲ 551312	CG20200227-B	200 Cu. ft.	19 lbs	469.99
▲ 551341	CG20250227-B	250 Cu. ft.	30 lbs	569.99
▲ 551313	CG20275227-B	275 Cu. ft.	32 lbs	599.99
▲ 551337	CG20300227-B	300 Cu. ft.	33 lbs	667.99
▲ 551338	CG20325227-B	325 Cu. ft.	38 lbs	709.99
▲ 551314	CG20375227-B	375 Cu. ft.	40 lbs	867.99
▲ 551315	CG20450227-B	450 Cu. ft.	46 lbs	969.99
▲ 551343	CG20500227-B	500 Cu. ft.	56 lbs	1057.99
▲ 551342	CG20600227-B	600 Cu. ft.	61 lbs	1299.99
▲ 551336	CG21000227-B	1000 Cu. ft.	93 lbs	1999.99

## FIREBOY FIRE DETECTION SYSTEMS - 4 ZONE SYSTEM

Easy installation. The system consists of a monitor, (1) input module for up to 14 smoke/heat detectors in a 12 VDC system, or (8) detectors in a 24 VDC system, plus up to (2) audible alarms connected to each zone (all sold separately). The system communicates via a 2-wire network cable with a maximum cable length of 3200'.



Item	Model	Description	Ship	Net
550415	FR-4000-R	Monitor/display (2-5/8") and input module	2 lbs	\$1699.99

## FIREBOY SMOKE AND FIRE ALARM

- One unit is recommended in each sleeping area, salon, galley, engine/generator room and electrical control room
- Dimensions: 4.25" D x 1.75" H
- Power: 9 Volt DC battery powered (Included)
- No wiring required
- Low battery indicator
- Test button easily accessible on cover of alarm
- Complies with U.S. Coast Guard Sect. 28.325(b) and Sect. 181.450 inclusive



Item	Model	Ship	Net
552601	SS-775	1 lbs	\$18.99

## PLASTIMO FIRE BLANKET

- Designed to smother kitchen and clothing fires
- Material: Fiberglass fire blanket (1.10m x 1.10m) in rigid ABS container



Item	Model	Container Dimensions	Ship	Net
552698	65757	200mm x 170mm x 30mm	3 lbs	\$62.99

Systems include:

- (1) Fire extinguisher
- 2" Round system status indicator light
- USCG approved mounting brackets
- Owner's manual with instructions

CG2 SERIES are automatic discharge only.

- USCG, Factory Mutual, ISO RINA and Bureau Veritas approved
- MA2 SERIES has a manual discharge option with the addition of a manual release cable (cable is sold separately).



- USCG, ISO RINA, Bureau Veritas, Factory Mutual approved



Item	Model	Max Volume Protected	Ship	Net
▲ 551326	MA20050227-BL	050 Cu. ft.	8 lbs	\$209.99
▲ 551316	MA20075227-BL	075 Cu. ft.	11 lbs	264.99
▲ 551317	MA20125227-BL	125 Cu. ft.	14 lbs	337.99
▲ 551318	MA20200227-BL	200 Cu. ft.	19 lbs	487.99
▲ 551319	MA20275227-BL	275 Cu. ft.	32 lbs	619.99
▲ 551331	MA20300227-BL	300 Cu. ft.	33 lbs	697.99
▲ 551334	MA20350227-BL	350 Cu. ft.	39 lbs	807.99
▲ 551320	MA20375227-BL	375 Cu. ft.	40 lbs	887.99
▲ 551332	MA20400227-BL	400 Cu. ft.	44 lbs	917.99
▲ 551333	MA20450227-BL	450 Cu. ft.	45 lbs	989.99
▲ 551321	MA20500227-BL	500 Cu. ft.	56 lbs	1077.99

❖ 1 or 2 zone systems available ❖ Pre-engineered systems available  
up to 4,000 cu. ft. - contact us at [www.defender.com](http://www.defender.com) or 800-628-8225 ❖

## THE MARINE EAST 6860 FIRE PORT - WHITE RING

- Permits a fire extinguisher to be discharged into the engine space
- Avoids fueling the fire by opening the compartment



Item	Model	Description	Ship	Net
550573	6860	2.7" diameter fire port	1 lbs	\$9.99

## FIREBOY SMOKE AND HEAT DETECTOR

- Supply voltage: 10-30 VDC
- Voltage, EMI and reverse polarity protected



Item	Model	Description	Ship	Net
550418		Photo electric smoke detector	1 lbs	\$79.99
550419		Heat detector 170°F	1 lbs	\$9.99

## FIREBOY CLEAN AGENT PORTABLE FIRE EXTINGUISHER

- The first clean-agent extinguisher to receive USCG approval
- Unlike dry chemical, it leaves no residue
- The agent is non-conductive electrically: Ideal for flammable liquids, including gasoline and diesel fuel as well as galley fires
- Will not cause cold shock to engines or electronic equipment
- Fully rechargeable with a 2 year limited warranty
- Model 70551 comes with mounting bracket - UL listed



Item	Model	Description	Ship	Net
▲ 550972	70551	5 lbs, 5BC rating	10 lbs	\$259.99
▲ 550973	71100	11 lbs, 1A10BC rating	23 lbs	\$17.99
552351	700228	Mounting bracket for 11 lbs model	8 lbs	102.99

## FIREBOY® - XINTEX® Fume & Carbon Monoxide Detectors

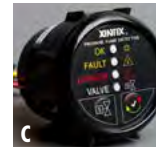

### A. G-1B-R GASOLINE FUME DETECTOR, ALARM & SENSOR

- Reverse polarity protected
- Audible and visual alarms
- Simple installation
- 2-3/16" round Black display (2-1/16" mounting hole)
- Alarms at 20% level
- Includes 20' of cable

Item	Model	Voltage	Ship	Net
552588	G-1B-R	9-30 VDC	1 lbs	\$179.99

### B. G-1BB-R GASOLINE FUME DETECTOR AND BLOWER CONTROL WITH SENSOR

- Reverse polarity protected
- Audible and visual alarms
- Automatic ventilation blower control
- 2-3/16" round Black display (2-1/16" mounting hole)
- Alarms at 20% level
- Includes 20' of cable

Item	Model	Voltage	Ship	Net
552590	G-1BB-R	9-30 VDC	1 lbs	\$187.99

### C. P-1BS-R PROPANE FUME DETECTOR WITH DISPLAY, SENSOR AND SOLENOID

- Reverse polarity protected
- Alarms at 20% level
- Solenoid valve and adaptor
- Solenoid valve control button
- Audible and visual alarms
- 2-3/16" round Black display (2-1/16" mounting hole)
- Includes 20' of cable
- Automatically closes solenoid valve

Item	Model	Voltage	Ship	Net
552593	P-1BS-R	9-30 VDC	2 lbs	\$207.99

### D. FIREBOY AUTOMATIC ENGINE SHUTDOWN SYSTEM

- Provides automatic shutdown to engine upon activation of the FireBoy Clean Agent system
- Display features an integrated horn, status lights and override switch for re-starting engine
- Shutdown capacity for up to (3) different circuits
- Additional units and wire harnesses available for second stations
- 1 year limited warranty
- 355 milliamps

Item	Model	Voltage	Ship	Net
551421	ES-3000-01	12 VDC	2 lbs	\$247.99

24 VDC available by special order. Please call Defender at (800) 628-8225 for pricing.

### E. FIREBOY-XINTEX CARBON MONOXIDE DETECTOR

- Electrochemical sensor - immediate and stable sensing reduces false alarms
- Ultra-low current draw - <4 mA
- Microprocessor controlled
- Conformal coated circuit board for added protection
- Time-weighted average CO measurement process constantly monitors all CO levels
- Highly resistant to most chemicals, solvents and cleaners
- Operating temperature: -30° F to 158° F • 3.5" x 3.5" x 1" • 1 year limited warranty

Item	Model	Power	Ship	Net
© 552599	CMD5-MD-R	12/24 VDC	2 lbs	\$102.99
© 552714	CMD5-MB-BR	Battery (Black or White)	2 lbs	119.99

### FIREBOY-XINTEX ACCESSORIES

Item	Model	Description	Use With	Ship	Net
552597	FS-T01-R	Gas and propane sensor, Plastic housing, 20' sensor cable	G-1, G-2, P-1, P-2	1 lbs	99.99
551615	SV-1	Solenoid valve 1/4"	S-2A, S-2LM, C-1	1 lbs	59.99
551932	CNV-12-1	12/24/32 VDC reducer	All Models (0.5 A MAX)	1 lbs	73.99
551937	RH-1	85 dB remote horn	M-2A, S-2A, MB-2, S-2LM	1 lbs	23.99
551935	MB30-RLY	18A blower aux. relay	MB-1, S-2A	1 lbs	23.99



**BLUE PERFORMANCE LEE CLOTH - BUNK SAFETY GUARD**

- Fixes to your bunk preventing you from rolling off
- Can also be used to keep large items in place
- 67" L x 21" H with 14-9/16" hold down straps
- Made from a nylon/ripstop/webbing
- Color: Light Gray



Item	Model	Ship	Net
100426	BP600	2 lbs	\$74.99

**HYPERVENT CONDENSATION PREVENTER**

- Consists of 3/4" spun polymer woven into a large open configuration that is bonded to a breathable fabric layer
- Does not compress preventing dampness under cushions
- Lightweight and easy to cut
- Washable
- Sold by the foot - Max run is 16.6 yds (50')
- Color: White



Item	Dimension	Ship/Ft	Net/Ft
401134	3/4" thick x 39" wide	1 lbs	\$10.59

**OPEN CELL MATTRESS AND CUSHION FOAM**

- For boat bunks, seat cushions, day beds, couches, etc.
- Uncovered: use Sunbrella, Sequest or Sailcloth to cover



80" L X 36" W				80" L X 54" W				80" L X 108" W				
Thick	Item	Ship	Net	Item	Ship	Net	Item	Ship	Net	Item	Ship	Net
2"	D 400788	42	\$56.99	D 400793	82	\$71.99	D 400798	178	\$112.99	D 400799	28	169.99
3"	D 400789	67	81.99	D 400794	150	102.99	D 400800	38	225.99	D 400801	50	282.99
4"	D 400790	126	97.99	D 400795	150	133.99	D 400802	60	334.99			
5"	D 400791	126	122.99	D 400796	178	169.99						
6"	D 400792	157	143.99	D 400797	30	194.99						

**DRI-DEK™ VINYL DECK TILES**

- Create a custom, non-skid, ventilated surface that resists mold and mildew
- Perforated 9/16" thick Oxy-BI vinyl also resists UV, chemicals and fire
- Perfect for lining anchor lockers, cockpits, & engine rooms
- Nothing protects like Dri-Dek
- 5 year warranty



Please specify color: Blue, White or Almond.

Item	Description	Ship	Net/Ea
752942	12" x 12" Tile	1 piece/1 lbs	\$5.99
752944	2" x 2" Corner	10 pieces/1 lbs	1.49
752946	2" x 12" Edge	3 pieces/1 lbs	2.99

**GENUINE PREMIUM MARINE GRADE CARPETING**

- 100% woven olefin polypropylene carpet with 3/16" textured tuft
- UV stabilized and stain resistant
- Special marine backing for tuft lock and ravel prevention
- Lightweight, drains easily and is flexible to mold to hull contours
- Adheres with Nautolex adhesive or any contact cement or resin

**Specify carpet color when ordering:**

- Smoke • Metallic Gray • Marble Gray • Charcoal • Driftwood • Black
- Royal Blue • Denim Blue • Indigo • Navy • Cardinal • Garnet • Sunset
- Aqua • Teal • Gulf Blue • Forest • Cocoa • Sand • Light Beige • Plum



Item	Description	Ship per Linear Foot	Net
755762	72" Wide, 14 oz.	2 lbs	\$11.49
755763	96" wide, 14 oz.*	2 lbs	15.99

Sold by the linear foot.

Carpeting is a special order and cannot be cancelled or returned. Ships direct from manufacturer. Miami Corp does not charge a drop ship fee and there are no minimums. Note: 96" wide only available in Royal Blue, Sand, Black, Navy, Cocoa, Forest Green

**AQUA TURF CARPET SAMPLE CARD - swatches of 21 colors.**

Item	Ship	Net
755764	1 lbs	\$4.99



**MARINE CARPET ADHESIVE**

- Adheres marine carpet to fiberglass, wood, metal or concrete
- Quart size
- Completely waterproof after curing
- Water based
- Coverage 25-30 sq. feet

Item	Ship	Net
753298	3 lbs	\$31.99



**NAUTOLEX MARINE VINYL FLOORING**

- Appearance of outdoor carpeting
- 3 year warranty
- Provides strength and skid resistance needed for marine environments
- For interior and exterior boat floors
- UV, stain, mildew and abrasion resistant
- Ship 4 lbs./yd. Net \$18.99/ld.



Nautolex Color Guide Page 158

74" WIDE		72" WIDE		72" WIDE	
Item	Color	Item	Color	Item	Color
756532	Interwoven Warm	753037	Sandstone	753039	Shark Gray
756533	Interwoven Cool	753041	Dark Blue	753045	Storm Gray
756534	Sisal Warm	753047	Natural	753043	Black
756535	Sisal Cool				

**NAUTOLEX MARINE VINYL FLOORING SAMPLE CARD**

- Popular deep textured decking which simulates the luxury look of carpeting
- Includes (11) color swatches

Item	Model	Ship	Net
401260	80884	1 lbs	\$3.99



**NAUTOLEX ADHESIVE 88**

- For installation of Nautolex or other heavy-duty coverings
- Covers up to 50 sq. ft. per quart

Item	Model	Size	Ship	Net
753048	7193	Quart	3 lbs	\$36.99
753049	7194	Gallon	12 lbs	109.99



Treadmaster products are resistant to UV degradation, oils, chemicals and abrasion, and the permanent application to most surfaces is easy.



**TREADMASTER SELF-ADHESIVE DIAMOND SHEETS**

- Nonskid, anti-glare with high insulating properties
- Can be used on PVC and hypalon tubes

Specify color: Black, Teak, Gray or White Sand

Item	Size	Ship	Net
756142	47-1/4" x 35-1/2" x 5/64"	8 lbs	\$151.99



**TREADMASTER M-TEC SMALL DIAMOND**

- Pressure sensitive adhesive backing
- Can be used on PVC and hypalon tubes

Specify color: Gray, Black or White

Item	Size	Ship	Net
755931	47-1/4" x 35-1/2"	7 lbs	\$151.99

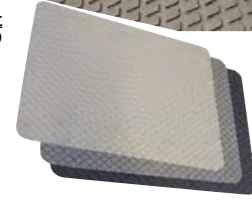

**TREADMASTER M-TEC ULTRA GRIP (Aggressive grip pattern)**

Specify color: Gray, Black or White

Item	Size	Ship	Net
755932	47-1/4" x 35-1/2"	5 lbs	\$151.99

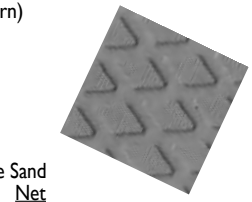

**TREADMASTER ORIGINAL DIAMOND SHEETS**

- Bonds to fiberglass, wood and metal surfaces using Treadmaster marine adhesive

Specify color: Gray, Blue, Teak, Black, Light Gray or White Sand

Item	Size	Ship	Net
755694	47-3/8" x 35-1/2" x 1/8"	7 lbs	\$129.99



**TREADMASTER MARINE ADHESIVE**

- Used to apply Treadmaster "Original" or "Sport" sheets
- 2-part epoxy system provides a permanent bond to most decks
- Coverage is approximately one sheet per can

753009 JTWUEPX Quart Ship 2 lbs Net \$63.99

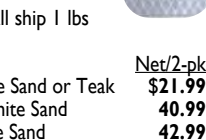

**TREADMASTER DIAMOND SELF-ADHESIVE STEP PADS (2-PK)** All ship 1 lbs

Cut with rounded corners but can be trimmed to size.

Item	Size	Colors	Net/2-pk
755692	10-3/4" x 5-1/4"	Light Blue, Black, Gray, White Sand or Teak	\$21.99
756143	5-1/4" x 22-5/8"	Blue, Teak, Gray or White Sand	40.99
756144	7-7/8" x 16-1/4"	Teak, Gray or White Sand	42.99

**TREADMASTER TREADCOTE RECONDITIONER**

- Quick and easy way to rejuvenate heavily weathered or stained Treadmaster

Item	Select Color	Size	Ship	Net
755690	Blue, Teak, Gray or White Sand	(1) Liter	3 lbs	\$99.99



SEE PAGE 158 FOR TREADMASTER COLOR SELECTION GUIDE OR VISIT WWW.DEFENDER.COM

**72" WIDE LONSEAL LONWOOD MARINE FLOORING**

Lonwood Marine and Lonmarine Wood (IMO) are Lonseal's high-performance, slip-resistant marine safety floorings. The Lonwood Marine Series is available in glossy styles. Lonmarine Wood - IMO Series is available in a matte style and has been specifically manufactured to comply with IMO/USCG specifications for international and commercial markets.



**LONWOOD MARINE - Applications - Interior**

Item	Model	Description	Style	Ship/ft	Net/ft
401107	W72G	Teak and Holly gloss	High gloss/wet look	5 lbs	\$39.99
401108	W74TS	Teak and Holly Topseal	Satin/low gloss	4 lbs	39.99

**LONMARINE WOOD IMO - Applications - Interior and Protected Exterior**

Item	Model	Description	Style	Ship/ft	Net/ft
401511	MW370	Teak and Holly	Matte	5 lbs	\$39.99
401512	MW371	Maple and Teak	Matte	5 lbs	39.99
401513	MW373	Mahogany and Holly	Matte	5 lbs	39.99
401514	MW375	Teak and Ebony	Matte	5 lbs	39.99
401516	MW3473	Solid Mahogany	Matte	5 lbs	39.99
401517	MW3475	Teak (No stripes)	Matte	5 lbs	39.99
402592	MW378	Teak and Ivory	Matte	5 lbs	39.99
402593	MW379	Antique and Ivory	Matte	5 lbs	39.99

\* Lonseal flooring must be applied using the Lonseal adhesive. Failure to use Lonseal adhesive voids the manufacturer's warranty. Please visit www.lonseal.com for more information.

**LONMARINE ADHESIVE AND TOOLS**

Item	Model	Description	Ship/ft	Net/ft
756530	ZZ800	Lonseal U-notch epoxy trowel	1 lbs	12.99

**LONSEAL LONWOOD MARINE FLOORING TRIM**

- Plastic trim designed to match and finish the edges of Lonwood Marine Flooring
- Pre-drilled every 4"
- Raised 1/4" above flooring after installation

Item	Model	Description	Size	Ship	Net
401840	ZZTRIM05	Teak color	6' x 1"	1 lbs	\$21.99
401841	ZZTRIM06	Holly	6' x 1"	1 lbs	21.99
401842	ZZTRIM07	Walnut	6' x 1"	1 lbs	21.99
401843	ZZTRIM08	Cherry	6' x 1"	1 lbs	21.99
402594	ZZTRIM10	Antique	6' x 1"	1 lbs	21.99

Additional handling note: Most carriers impose an extra handling fee of \$10.50 that will be added to your shipping charges if it applies.





Defender is your #1 Source for Sunbrella fabric. Visit [defender.com](http://defender.com) for a complete color/fabric representation.

From sea to shining sea,  
Sunbrella is on it!

### Sunbrella Shade Fabrics

#### SUNBRELLA MARINE FABRIC • WATER REPELLENT

Sunbrella Marine fabric is a favorite for marine use and offers excellent fade and weather resistance. It is soft and easy to work with and is water repellent, mildew resistant and well suited for awnings, boat covers, biminis, dodgers, sail bags, winch covers, curtains, cushions and much more. • **Fabric:** Solution-dyed woven acrylic • **Finish:** Fluorocarbon • **Weight:** 9.25 oz. per square yard

OFFERED IN 75+ COLORS!

	Item	Ship	Starting at
46" WIDE max run 65 yards	752766	2 lbs/yd	\$20.99/yd
60" WIDE max run 60 yards	752769	2 lbs/yd	23.99/yd
80" WIDE max run 30 yards	752778	4 lbs/yd	34.99/yd

10 year guarantee against loss of color or strength from normal exposure conditions

#### SUNBRELLA PLUS MARINE FABRIC • WATER REPELLENT

Highly moisture-resistant, Sunbrella Plus is dimensionally stable, yet soft and easy to work with. Bright and colorfast, it has excellent abrasion resistance. It's ideal for use in biminis, dodgers, cockpit covers, travel covers, camper tops and canopies.

• **Fabric:** Solution-dyed woven acrylic • **Finish:** Polyurethane back-coated  
• **Front:** Fluorocarbon • **Weight:** 10 oz. per square yard

OFFERED IN 14+ COLORS!

NOTE: Full enclosures should be vented for air circulation

	Item	Ship	Starting at
60" WIDE max run 60 yards	100887	2 lbs/yd	\$32.99/yd
80" WIDE max run 50 yards	100888	2 lbs/yd	44.99/yd

5 year guarantee against loss of color or strength from normal exposure conditions

#### SUNBRELLA SUPREME MARINE FABRIC • WATERPROOF

Sunbrella Supreme combines a premium, waterproof fabric with the beauty and durability for which Sunbrella brand marine fabrics are known. This exterior marine fabric has a 100% solution-dyed acrylic face and an acrylic flocking on the underside for exceptional durability and colorfastness. It is constructed using a unique bonding process that securely adheres the acrylic flocking to the Sunbrella fabric providing a waterproof barrier. Excellent for covers, canopies and T-Tops. • **Fabric:** 100% Solution-dyed acrylic • **Finish:** Fluorocarbon

• **Weight:** 13 oz./square yard

OFFERED IN 10+ COLORS!

	Item	Ship	Starting at
60" WIDE max run 40 yards	100889	2 lbs/yd	\$43.89

5 year guarantee against loss of color or strength from normal exposure conditions

### Sunbrella Outdoor Throw Blankets

#### SUNBRELLA OUTDOOR THROW BLANKET

- Each and every luxurious throw is handwoven with pride in the USA
- Designed for indoor and outdoor use
- Material: Base fabric is 100% Sunbrella acrylic
- Finish/Coating: Soil, stain, water and mildew resistant
- Dimensions: 44" x 72" with 2" Sewn Fringe

Please Specify Color: Ginko/Natural, Gray/Natural, Heather Beige/Natural, Indigo/Natural, Melon/Natural, Tuscan/Natural

Item	Pattern	Ship	Net
101385	Chevron	3 lbs	\$229.00

Please Specify Color: Natural/Natural, Corn Flower Blue/Natural, Black/Natural, Granite/Natural

101386	Zig Zag	3 lbs	\$229.00
--------	---------	-------	----------

Please Specify Color: Marine/Natural, Heather Beige/Natural

101387	Stripes	3 lbs	\$269.00
--------	---------	-------	----------

### Sunbrella Trim

#### SUNBRELLA CUSTOM CENTERFOLD 7/8" BINDING

- 100% solution-dyed acrylic with natural fold in center
- Will not fade or weaken from normal exposure to sunlight or moisture

Please specify color: Pacific Blue, Cadet Gray, Navy, Captain Navy, Natural, Black, Forest Green, Linen, Burgundy, Oyster

Max run 200 yards

Item	Yardage	Size	Ship	Net/Ft
100539	Sold by the foot	7/8"	1 lbs/foot	\$0.49



#### 3M GENERAL TRIM ADHESIVE

Fast-drying, high strength. Excellent for most marine trim, fabric and foam. Great for headliner.

Item	Model	Size	Ship	Net
753081	08088	18.1 oz.	2 lbs	\$19.99

#### 3M SUPER TRIM ADHESIVE

- Aerosol contact adhesive
- Designed for bonding vinyl tops, heavyweight liners and hood silencer pads where high strength and heat resistance are needed

Item	Model	Size	Ship	Net
754121	08090	19 oz.	2 lbs	\$24.99

### Sunbrella Upholstery Fabrics

#### SUNBRELLA ELEMENTS UPHOLSTERY FABRIC • WATER REPELLANT

Sunbrella Marine Fabric is a popular choice for casual furniture and cushions. This fabric has a moisture, stain and soil resistant finish. • **Fabric:** Solution-dyed woven acrylic • **Finish:** Fluorocarbon • **Weight:** 6.5 oz./square yard

OFFERED IN 60+ COLORS!

	Item	Ship	Starting at
54" WIDE max run 60 yds	100712	2 lbs/yd	\$21.49/yd

5 year guarantee against loss of color or strength from normal exposure conditions

#### SUNBRELLA FUSION UPHOLSTERY FABRIC • WATER REPELLANT

The Fusion Collection is water repellent and mildew resistant, delivers highly decorative upholstery fabrics for stylish, modern spaces both indoors and out. Perfect for large upholstered furniture pieces, the collection includes coordinating geometrics, asymmetrical stripes and clean colors to create fun and stylish accents. • **Fabric:** Solution-dyed woven acrylic • **Finish:** Fluorocarbon • **Weight:** 14.5 oz./square yard

OFFERED IN 150+ COLORS!

	Item	Ship	Starting at
54" WIDE max run 60 yds	101078	2 lbs/yd	\$30.49/yd

5 year guarantee against loss of color or strength from normal exposure conditions

#### SUNBRELLA MAKERS UPHOLSTERY FABRIC • WATER REPELLANT

Sparkled by handmade practices, this upholstery fabric displays high-depth textures and designer styles. An exclusive fabric line, spun with mélange yarn for a thick, wool consistency. The indoor/outdoor fabric carries a harmony between high performance and a homespun appearance.

• **Fabric:** Sunbrella acrylic, PVC, and polyester • **Finish:** Fluorocarbon • **Weight:** 17.3 oz./square yard

OFFERED IN 40+ COLORS!

	Item	Ship	Starting at
54" WIDE max run 60 yds	101093	2 lbs/yd	\$36.49/yd

5 year guarantee against loss of color or strength from normal exposure conditions

#### SUNBRELLA RENAISSANCE UPHOLSTERY FABRIC • WATER REPELLANT

With a handmade look and broad color palette, the line is an extension of the Renaissance Collection. The upholstery fiber contains 50% recycled and 50% virgin Sunbrella acrylic. The ideal blend of recycled and virgin fiber ensures that it meets stringent performance standards. • **Fabric:** 50% recycled and 50% virgin Sunbrella acrylic • **Finish:** Fluorocarbon • **Weight:** 11 oz./square yard

OFFERED IN 10+ COLORS!

	Item	Ship	Starting at
54" WIDE max run 60 yds	101141	2 lbs/yd	\$35.49/yd

5 year guarantee against loss of color or strength from normal exposure conditions

#### SUNBRELLA SHIFT UPHOLSTERY FABRIC • WATER REPELLANT

Exceptionally long-lasting fabric is made with a rare blend of Sunbrella acrylic, PVC, and polyester. The line integrates classic patterns with present-day style. Sunbrella Shift uses include slipcovers, patio furniture, indoor and outdoor furniture, home accessories, umbrellas, and much more. • **Fabric:** Blend of Sunbrella acrylic, PVC, and polyester • **Finish:** Fluorocarbon • **Weight:** 15.3 oz./square yard

OFFERED IN 40+ COLORS!

	Item	Ship	Starting at
54" WIDE max run 60 yds	101401	2 lbs/yd	\$24.49/yd

5 year guarantee against loss of color or strength from normal exposure conditions

### YachTrac™ Drapery System

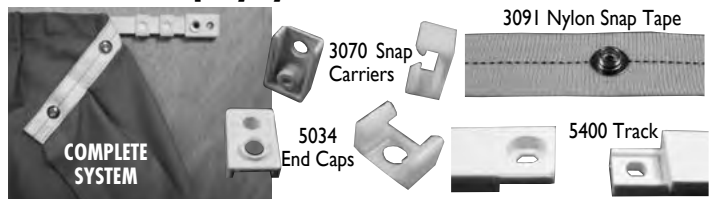

Our most popular system for drapes. Complete; easy-to-install; allows either straight or pleated curtains. Flexible drapery track system curves to a 15" radius and allows for end-to-end placement to form any desired length. Drapes snap on and off for easy cleaning. The compact size, thin profile and decorator styling make it a popular designer item. Molded of highest quality plastic. White finish. Nylon pieces prevent corrosion. Velcro® may be used on edges so curtain does not fall away from window. Projects 3/8" from mounting surface. Color: White

Item	Model	Description	Ship	Net
650723	5400-1	Track 36" L x 5/8" W	1 lbs	\$7.99
650724	3070-1	Snap carriers; 14 pieces	1 lbs	5.99
650725	5034-1	End caps; 2 pack	1 lbs	3.99
650726	3091-1	Nylon snap tape; Heavy-duty 1" wide nylon with non-corrosive nickel plated brass snaps (4-1/4" between snaps)	1 lbs/yd	2.99/yd.

#### SEAMING TAPE

BAINBRIDGE DOUBLE SIDED SEAMING TAPE - A rubber based adhesive tape that adheres synthetic materials firmly in place.

Item	Model	Size W x L	Ship	Net
100895	J351	1/4" x 72 Yards	1 lbs	\$5.99
100896	J352	3/8" x 72 Yards	1 lbs	7.99
100897	J353	1/2" x 72 Yards	1 lbs	9.99



## Sewing Machines, Kits & Accessories

### RELIABLE BARRACUDA SEWING MACHINE

- Zig-zag, straight stitch and reverse
- Portable, all metal walking-foot machine
- Built-in speed reducer gives the machine extra torque to get through the toughest jobs
- A full .47" clearance under the foot allows you to sew 10 or more layers of heavy canvas or up to 8 layers of Sunbrella-Plus

**Includes full accessory kit:** Extra needles (type 135 x 17 needles), bobbins, piping and zipper foot, thread stand, screwdriver and instruction book

**Craftsman Kit - Includes full accessory kit, Cuda case and task light**

Item	Model	Ship	Net
101376	200ZW/CRAFTSMAN	55 lbs	\$699.00

**Sewing Machine - Includes full accessory kit**

101375	200ZW	38 lbs	499.00
--------	-------	--------	--------

**Sewing Machine Case**

101377	200ZWACUDACASE	Wood case	18 lbs	229.00
101398	200ZWCOCASE	Plastic case	18 lbs	119.00

**Sewing Machine Table Only - Sewing machine and light sold separately**

100905	STAND200ZW	48" plywood table top with storage drawer	42 lbs	179.00
--------	------------	-------------------------------------------	--------	--------

100912	NN42	Sewing Machine needles (10 pack) - 135 x 17 - Specify size	1 lbs	7.99
--------	------	------------------------------------------------------------	-------	------



3 Year Limited Manufacturer Warranty!



200ZW/CRAFTSMAN

STAND200ZW

**Cuda Crank Handwheel**

- Allows manual operation of the Baracuda
- Oversized wheel, made from solid steel

100904	200ZWCKIT	10 lbs	\$109.00
--------	-----------	--------	----------



### DEFENDER SEWING KIT

Includes needles, White twine, beeswax, sewing palm and 8-1/2" stainless steel rigging knife.

**Please specify:** Left or Right hand

Item	Description	Ship	Net
606811	Kit in canvas drawstring bag	2 lbs	\$45.99
606810	Kit without knife	1 lbs	35.99

This picture is not of the actual product, but for illustration only.



### SAIL PALM AND SEWING PALM

**A.** Extra-heavy protection; professional sailmaker's palm. Made of top grain leather, securely stitched and hand tied. Right hand use only.

Item	Description	Ship	Net
612314	Sail Palm	1 lbs	\$19.99

Note: A. Not shown

**B.** General purpose palm made of fine quality leather. All joints durably riveted. Specify for left or right hand when ordering.

Item	Description	Ship	Net
612313	Sewing Palm	1 lbs	\$16.99



### SPEEDY STITCHER SEWING AWL KIT

A heavy-duty awl that sews any heavy material with a lock-stitch like a machine. Kit includes awl, 180 yard spool of waxed tan nylon thread and an extra set of needles.

Item	Model	Ship	Net
612284	110	1 lbs	\$25.49

### HAND SEWING NEEDLES

Seven assorted needles for canvas and upholstery hand sewing.

Item	Model	Ship	Net
612315	C007	1 lbs	\$5.99

### BEESWAX

For waxing twine before whipping or sewing.

Item	Model	Size	Ship	Net
612307	C040	3 oz. cake	1 lbs	\$6.99
612308	C041	1 lbs block	1 lbs	29.99



### BAINBRIDGE SAILMAKERS NEEDLES

- All needles are handmade and hand polished for ease of use
- Tube packs contain assorted size needles

Item	Model	Description	Ship	Net
612574	C005	(5) assorted needles	1 lbs	\$11.99
612575	C021	(10) assorted needles	1 lbs	19.99
612576	C022	(20) assorted needles	1 lbs	34.99



### WAXED POLYESTER SAIL TWINE AND NYLON SEINE TWINE

- For whipping rope ends, splicing, reinforcing sail fittings, sail sewing and repair work
- Please specify color: White or Brown

Item	Size	Ship	Net
612285	1 oz., 28 yards	1 lbs	\$6.99
612286	4 oz., 110 yards	1 lbs	11.99
612287	16 oz., 440 yards	2 lbs	29.99
612288	4 oz., White flat lacing tape	1 lbs	8.99



### A. ANEFIL POLYESTER THREAD

- White thread for any type of sewing
- Size #46, 9,800 yards per 1 lbs.

Item	Model	Size	Ship	Net
612310	26863	1/2 lbs	1 lbs	\$20.99



### B. YACHT MARLINE

- Tarred special-coated polyester filament yarn

Item	Model	Size	Ship	Net
752494	TMF-4	1/4 lbs	1 lbs	\$9.99



### SEW ON VELCRO®

- Water resistant

Specify Color: Beige, Black Navy, White or Yellow

Item	Description	Width	Ship/Ft	Net/Ft
755954	Hook	3/4"	1 lbs	\$0.24
755955	Loop	3/4"	1 lbs	0.24
755956	Hook	1"	1 lbs	0.29
755957	Loop	1"	1 lbs	0.29
755958	Hook	2"	1 lbs	0.54
755959	Loop	2"	1 lbs	0.54

### SELF-ADHESIVE VELCRO

- Water resistant

Specify Color: Beige, Black Navy or White

Item	Description	Width	Ship/Ft	Net/Ft
755960	Hook	5/8"	1 lbs	\$0.44
755961	Loop	5/8"	1 lbs	0.44
755962	Hook	1"	1 lbs	0.54
755963	Loop	1"	1 lbs	0.54
755964	Hook	2"	1 lbs	0.99
755965	Loop	2"	1 lbs	0.99

## Zippers

### VISLON HEAVY DUTY SEPARATING ZIPPERS All ship 1 lbs

Extremely strong, lightweight and corrosion resistant. Double plastic sliders operate smoothly. Number 10 Vislon by YKK.

WHITE			BLACK		
Item	Length	Net	Item	Length	Net
101013	18"	\$4.99	101144	18"	\$4.99
100314	24"	5.99	101145	24"	5.99
100315	36"	7.99	101146	36"	7.99
100316	48"	8.99	101147	48"	8.99
100317	54"	9.99	101148	54"	10.99
100318	60"	10.99	101149	60"	10.99
100319	66"	11.99	101150	66"	10.99
100320	72"	12.99	101151	72"	12.99
100321	78"	13.99	101153	78"	12.99
100322	84"	14.99	101152	84"	14.99



### STAR BRITE SNAP & ZIPPER LUBRICANT

Use on boat snaps, metal and plastic zippers to protect against corrosion, reduce wear and friction, prevent binding and repel salt spray deposits.

- Great alternative to zipper wax
- Non-toxic, non-staining zipper grease

Item	Model	Size	Ship	Net
755012	89102	1.75 oz tube	1 lbs	\$7.49



### VELCRO CINCH STRAPS

Wrap lines, cable and hoses, or secure gear such as harnesses and safety equipment. (2) Straps. Marine grade. Color: Blue.

Item	Model	Size	Ship	Net
752523	90099	1" x 18"	1 lbs	\$4.69
752524	90105	1" x 36"	1 lbs	6.79



### VELCRO ALL PURPOSE ADHESIVE

Use to attach products to difficult or rough surfaces where an extra strong bond is desirable or in areas exposed to weather year round.

Item	Model	Size	Ship	Net
752527	90065	1 oz. tube	1 lbs	\$2.49

### COMPLETE CANVAS WORKER'S GUIDE

Simple guide for canvas work on a home sewing machine.

Item	Description	Ship	Net
050356	Paperback, 186 pages	2 lbs	\$19.99

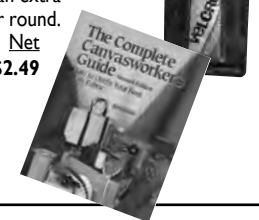

**Fasteners**



A. CANVAS FASTENER AND TOOL KIT - Ships 1 lbs				
Item	Model	Description	Net	
755575	970145	144 pieces with steel punch	\$27.99	
B. CANVAS SNAP & BUTTON KIT - Ships 1 lbs				
Item	Model	Description	Net	
755578	970036	Small, 36 pieces	\$10.49	
755579	970063	Large, 72 pieces	20.99	
C. LIFT A DOT FASTENER KIT - Ships 1 lbs				
Item	Model	Description	Net	
755581	MK-801	50 pieces	\$33.99	
D. SNAP FASTENER KIT - Ships 1 lbs				
Item	Model	Description	Net	
755580	MK-802	100 pieces Includes snap installation tool	\$26.99	
E. TWIST FASTENER KIT - Ships 1 lbs				
Item	Model	Description	Net	
755582	MK-800	25 pieces	\$33.99	
F. STAINLESS STEEL COTTER PIN PACK - Ships 1 lbs.				
Item	Model	Description	Net	
755577	970001	84 pieces	\$26.49	
G. CANVAS SNAP AND TOOL KIT WITH PLIERS - Ships 1 lbs				
Item	Model	Description	Net	
755576	970162	73 pieces with snaps and pliers	\$29.99	
H. HANDI-MAN MATE'S KIT - Ships 8 lbs				
Item	Model	Description	Net	
755590	WMMK2	840 assorted screws, nuts, bolts and washers	\$124.99	
I. HANDI-MAN BOSUN'S KIT - Ships 4 lbs				
Item	Model	Description	Net	
755588	WMMK1	560 assorted screws	\$73.49	

For MORE detailed specifications and our COMPLETE selection of Handi-Man stainless steel fasteners, visit [www.defender.com](http://www.defender.com) or call 800-628-8225.

**Grommets and Fasteners**

**HANDI-MAN PLAIN BRASS GROMMET REFILL** - Ships 1 lbs.  
Plain brass grommets for canvas, plastic sheeting or tarpaulins.

Fig.	Item	Model	Description	Net
A	755583	561005	1/4", 48 pieces (24 sets)	\$3.99
A	755584	561006	5/16", 48 pieces (24 sets)	4.49
A	755585	561007	3/8", 48 pieces (24 sets)	5.99
A	755587	561009	1/2", 24 pieces (12 sets)	5.99

**HANDI-MAN CURTAIN FASTENERS** - Ships 1 lbs.

Fig.	Item	Model	Description	Net
B	755332	560162	Twist stud, two hole, 2 pack	\$5.89
C	755333	560172	Double prong twist, 2 pack	5.89
D	755334	560182	Eyelet and washer, 2 pack	4.89
E	755335	560192	Twist stud screw, 2 pack	8.99

**HANDI-MAN DURABLE DOT FASTENERS** - Ships 1 lbs.

Fig.	Item	Model	Description	Net
F	755328	560082	1/4" Cap and socket, 6 pack	\$3.59
G	755329	560102	Stud and eyelet, 6 set pack	2.69

**HANDI-MAN LIFT-THE-DOT FASTENERS** - Ships 1 lbs.

Fig.	Item	Model	Description	Net
H	755323	560012	Socket and clinch plate, 4 pack	\$7.99
I	755324	560022	Stud and cinch plate, 4 pack	6.99
J	755325	560032	Eyelet stud and washer, 4 pack	6.29
K	755326	560062	5/8" Wood screw stud, 4 pack	9.99
L	755327	560072	3/8" Machine screw stud, 5 pack	6.99

**HANDI-MAN EXTEND-A-SNAP CANVAS FASTENERS** - Ships 1 lbs.

Fig.	Item	Model	Description	Net
M	751111	560261	3/4" Snap extender, 4 pack	\$6.79



**Adhesive Backed Studs**



YKK SNAD SNAP ADHESIVE BACKED DOMED STUD				
• Color: White • Size: 40 mm • Peel and stick adhesive backing				
• Provides secure attachment without damaging the surface				
Item	Model	Ship	Net/10 Pack	
101402	PG3-0000-839-WHITE	1 lbs	\$9.99	
YKK SNAD SNAP ADHESIVE BACKED FLEXIBLE BASE BUTTON STUD				
• Color: Clear • Size: 25 mm • Peel and stick adhesive backing				
• Provides secure attachment without damaging the surface				
Item	Model	Ship	Net/10 Pack	
101403	TP9-0000-TV0-CLEAR	1 lbs	\$14.99	
YKK SNAD SNAP ADHESIVE BACKED FLEXIBLE BASE BUTTON STUD				
• Color: Clear • Size: 40 mm • Peel and stick adhesive backing				
• Provides secure attachment without damaging the surface				
Item	Model	Ship	Net/10 Pack	
101404	TT5-0000-TV0-CLEAR	1 lbs	\$25.99	

**Kits, Tools & Tool Sets**



LOXX FASTENER KITS • All ship 1 lbs.				
• Select material thickness up to 3mm or 4mm				
• Stainless steel and nickel plated brass				
Item	Model	Description	Starting At Net	
756931		Oval plate kit, 4-pack	\$18.99	
756932		5/8" Self-tapping kit, 4-pack	22.49	
757404	9590	Key	1.95	
C.S. OSBORNE SET IT YOURSELF GROMMET KIT All ship 2 lbs.				
• Complete kit contains everything you need to set grommets in canvas, nylon, mesh and plastic				
• Kit contains hole punch, grommet setting tool, anvil and (24) grommets [753177 and 753178 have (48) grommets]				
Item	Model	Size	Net	
753177	K234-0	1/4"	\$20.99	
753178	K234-1	9/32"	22.99	
753179	K234-2	3/8"	23.99	
753181	K234-3	7/16"	23.99	
753182	K234-4	1/2"	28.99	
IRONWOOD CANVAS CARE KIT				
• Pocket-sized canvas snap kit with lanyard				
• Contains everything a boater needs for boat canvas repairs				
• Plastic case will float even when full of canvas snaps				
• Includes replacement snaps, snap-setting tool and snap lube				
Item	Model	Ship	Net	
100069	008.3	1 lbs	\$18.99	

**BLIND "POP" RIVETS** All ship 1 lbs.  
Stainless Steel

Item	Dia.	Grip Length	Qty	Net	Aluminum				
752315	1/8"	3/8" - 1/2"	5	\$3.89	752317	1/8"	3/8" - 1/2"	12	\$2.99
752323	3/16"	1/4" - 3/8"	2	3.89	752320	5/32"	1/4" - 3/8"	10	3.19
752325	3/16"	3/8" - 1/2"	3	3.89	752332	1/4"	3/8" - 1/2"	5	3.59
752327	1/4"	1/4" - 3/8"	2	5.99	752333	1/4"	5/8" - 3/4"	2	3.39
752329	1/4"	3/8" - 1/2"	2	5.29	For use with aluminum spars where electrolysis is a concern.				

**TIME SAVER GRIP FAST KITS**

Complete kit includes (4) attachments and vise grips.  
Half kits do not include vise grips.

Item	Model	Description	Ship	Net
756930	MT3-7P	Complete metal kit, for setting buttons/eyelets	2 lbs	\$45.99
	T3-7P	Complete kit, metal/plastic for setting buttons/eyelets	2 lbs	41.99
755103	MT4-82A	Half kit, metal for setting cap/socket	1 lbs	19.99
755104	MT4-89A	Half kit, metal for setting eyelet/stud	1 lbs	22.99

**TIME SAVER TOOL GRIP KITS**

• (14) time saving, vise plier attachments  
• Special four-piece hole punch set  
• Complete variety of over 450 assorted fasteners  
• (1) 10" Vise grip by Peterson

Item	Model	Description	Ship	Net
755068	T5-4 HD	Complete kit	4 lbs	\$78.99

**IRONWOOD STAINLESS STEEL TOP SNAPPER SNAP TOOL**

• Helps prevent torn canvas when snapping or unsnapping  
• Ideal for boat tops, boat covers and tonneau covers  
• Lifetime manufacturer's warranty

Item	Model	Ship	Net
753183	008.1	1 lbs	\$18.99

**HANDI-MAN HAND CANVAS PLIERS FOR SNAPS**

• Specially made for working with canvas and snaps  
• Sold individually

Item	Model	Ship	Net
755574	990691	1 lbs	\$14.79



**Shock Cord** Ships 25' lbs. Sold by the foot.  
Please specify: **Black, Yellow, Red, Blue, Green, Orange**  
**Color:**  
**White with Black tracer**

Item	Size	Net/ft	Item	Size	Net/ft
752673	1/8"	\$0.18	752671	1/8"	\$0.18
752685	3/16"	0.22	752683	3/16"	0.22
752697	1/4"	0.40	752695	1/4"	0.22
752709	5/16"	0.49	752707	5/16"	0.49
752722	3/8"	0.79	752720	3/8"	0.79
752733	1/2"	1.65	752732	1/2"	1.65



**FASTEX SHOCK CORD FASTENERS** - All ship 1 lbs

Corrosion-proof. Molded. Insert shock cord and slide collar over end of hook.

Item	Size	Material	Net/Ea	Item	Size	Material	Net/Ea
752570	1/4"	Black Delrin®	\$1.49	752573	5/16"	Black Delrin	\$3.99

**PLASTIC SHOCK CORD CLIPS** - All ship 1 lbs

For tie downs, snatch block cords, shroud silencers, etc. Injection molded nylon.

Color: Black

Item	Cord Size	Net	Item	Cord Size	Net
754539	to 1/4"	\$0.79	754540	to 5/16"	\$0.79

**SEA-DOG SHOCK CORD HOOKS & CRIMPS** - All ship 1 lbs

Easy hook attachment for shock cord. 304 Stainless Steel. Each model includes (2) hooks and (2) crimps.

Item	Size	Net/Pair	Item	Size	Net/Pair
756215	1/4"	\$3.49	756198	3/8"	\$4.99
756187	5/16"	3.99			

**SHOCK CORD C-CLAMPS** - All ship 1 lbs

Stainless steel clamps used to form a loop in shock cord. One clamp is sufficient to 1/4"; use two clamps for 5/16" and above.

Item	Size	Net/100	Item	Size	Net/100
752593	1/8" - 3/16"	\$11.99	752599	3/8"	\$13.99
752595	1/4"	12.99	752601	1/2"	13.99
752597	5/16"	12.99			

**C-CLAMP PLIERS**

Specially made to grip C-clamps and clinching rings (hogrings) from 3/16" to 1/2" in diameter. Handles are spring loaded to hold the ring until it is clamped on. Overall length 6-7/8".

Item	Ship	Net
752602	1 lbs	\$22.99



**CORD CLOSURES**

**BARRELOC** drawstring closure for hoods, jackets, duffel or sleeping bags. Slip the drawstring into the hole and the spring lock holds the drawstring tight. Stainless steel spring.

Item	Cord Size	Color	Ship	Net/Pair
752562	3/16"	Black	1 lbs	\$2.99



**Perfect Bungees by Bihlerflex** All ship 1 lbs

- Made completely of polyurethane – no rubber
- Withstands salt water, oil, ozone and chemicals
- Allows for a stretch up to twice its original length and won't crack, break, become brittle or scuff

**STRAP**

Heavy duty, load-bearing straps. Available with galvanized, stainless steel "S" hooks.

Please specify color: Black, Blue or Red

Item	Model	Size	Net
755837	PB18	18"	\$4.79
755838	PB24	24"	5.29

**BUNGEE CORD**

With nylon ends that won't scratch or gouge.

Please specify color: Red, Blue or Black

Item	Size	Net
755600	12"	\$4.99
755601	24"	5.29

**STAR BRITE BUNGES WITH STAINLESS HOOK ENDS (5 Pack)**

- Polyester elastic cord for maximum durability and UV resistance
- Stainless steel hooks and stops will not rust, pit or discolor

Item	Length	Diameter	Ship	Net
751260	6"	5/32"	1 lbs	\$5.49
751270	10"	5/32"	1 lbs	6.49

**SHOCKLES MINISHOCKLE™ SHOCK CORD BY DAVIS**

The patented MiniShockle™ is a combination of double-strength shock cord, strong tubular nylon webbing and anodized marine-grade carabiner fasteners on each end. • Stretches to twice its static length

- Carabiners prevent accidental unfastening

Item	Cord Size	Color	Ship	Net/Pair
003018	12"	Black	1 lbs	\$12.99
	18"	Black	1 lbs	13.99
	24"	Black	1 lbs	14.99

**WHITECAP ADJUSTABLE JAW BUNGEE - 10 PACK**

- Length: 12", Color: Black
- Includes no-slip 1" jaw ball for adjusting length
- Bungees can be connected to each other to extend length

Item	Model	Description	Ship	Net
756923	JB-100716B	Adjustable jaw bungee	1 lbs	\$11.99

**SHOCK CORD COVER CLIP**

- 3-piece unit installs onto fabric
- Use with lacing knob for fast, simple tie-down
- Works like a flexible grommet

Please specify color: Black or White

Item	Ship	Net
100893	1 lbs	\$3.99

**SHOCK CORD LACING KNOB**

- Use with a cord cover clip for a fast and simple tie-down
- Attaches with a #6 screw (not included) • Sold individually

Please specify color: Black or White

Item	Ship	Net
100894	1 lbs	\$0.99

## Webbing and Accessories

**A**

**B**

**C**

**D**

**E**

**F**

**G**

**H**

**I**

**SUNCOR WEBBING ACCESSORIES**

- Application: 1" webbing
- All ship 1 lbs

Item	Model	Description	Material	Net
A	101389 S0205-0025	Cam buckle	316 SS	\$6.99
B	101390 S0231-0025	Web shackle	316 SS	5.99
C	101391 S0211-0025	Double "J" hook	304 SS	6.99
D	101392 S0220-0025	Fixed bimini clip	304 SS	3.99
E	101393 S0216-0025	Adjustable webbing slide	304 SS	4.99
F	101394 S0223-8025	Harness clip with D-ring	316 SS	13.99
G	101395 S0221-0025	Swivel webbing clip	316 SS	7.99
H	101396 S0217-0025	Star adjuster	316 SS	12.99
I	101397 S0224-0025	Footman's loop	316 SS	5.99

**COLORED NYLON WEBBING**

Nylon webbing has a soft touch and exceptional strength.

Please specify: Red, Royal Blue, Forest Green, White, Yellow or Black

Item	Width	Breaking Strength	Ship/Ft	Net/Ft
100082	1"	2200 lbs	1 lbs	\$0.39

**POLYESTER TUBULAR WEBBING**

- Pliable weave, selected for flexibility
- Easy to tie and untie – ideal for sail making, sail ties, etc.
- Color: White with Black tracer

Item	Width	Breaking Strength	Ship/Ft	Net/Ft
755143	1"	1900 lbs	1 lbs	\$1.09

**ASTRUP NYLON WEBBING**

- The maximum continuous length we normally order is 165'
- Custom lengths over 165' may be available by special order; call Defender 800-628-8225

Item	Width	Color	Ship/Ft	Net/Ft
100501	2"	White	1 lbs	\$1.49
755258BLK2--	2"	Black	1 lbs	2.39

**BUCKLES FOR NYLON OR DACRON WEBBING**

Non-slip 1" buckles provide a positive hold on very smooth nylon or dacron webbing when webbing is threaded through the buckle. For 1" webbing.

Item	Description	Ship	Net
752528	Nickel plated steel	1 lbs	\$1.99 ea.

**WEATHERPROOF SNAPHOOKS-** All ship 1 lbs.

For shoulder straps, flag halyards and tie-downs. **Standard** has a standard tongue snaphook. **Locking lip** has a tongue groove lock to prevent tongue from disengaging to withstand higher loads.

Item	Description	Net Each	Locking Model
752535	Standard with webbing eye	\$1.39	
752537	Locking with webbing eye	1.49	
752540	1" tri-ring to snap snaphook onto	0.25	

**ASTRUP STANDARD SIDE RELEASE BUCKLES**

Standard male-female buckle with patented clip wings.

Item	Size	Ship	Net
752529	1"	1 lbs	\$2.89
752532	2"	1 lbs	5.99

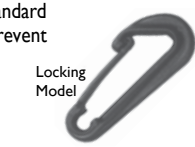

**Seat and Storage Covers**

**Taylor Made Universal T-Top Center Console Cover**

This trailerable T-Top console cover is secured to the underside of the fixed T-Top structure and will enclose any size console, helm seat and T-Top support combination with a maximum base perimeter (at the deck) of 18' or less.

- All console covers measure 48" W x 60" L x 66"H
- Adjustable straps allow the cover to conform to most console configurations
- Helm seats can also be protected on boats with smaller consoles and T- Tops
- Heavy duty marine grade zipper allows easy installation and removal



Please Specify Color: Hot Shot™/Blue or Hot Shot™/Gray

Item	Description	Ship	Net
001267	Designed to fit T-Top boats up to 25' long	6 lbs	\$145.99

**Taylor Made Blue Rip/Stop Polyester Covers**

Designed to protect your seats and electronics from the damaging marine environment.

- Breathable; mildew and water resistant
- UV protection
- 600 denier Rip / Stop polyester with polyurethane coating
- Heavy duty with a draw string hem and air vents

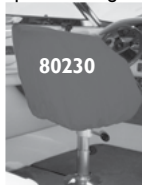

Item	Model	Description	H x W x D	Ship	Net
101188	80230	Helm/Bucket seat/Fixed back	24" x 24" x 22"	3 lbs	\$29.99
101189	80240	Small swingback seat	36" x 36" x 20"	4 lbs	38.99
101190	80245	Large swingback seat	36" x 40" x 20"	5 lbs	38.99
101191	80400	Small center console	42" x 36" x 24"	5 lbs	46.99
101192	80410	Medium center console	44" x 40" x 30"	6 lbs	49.99
101193	80420	Large center console	45" x 46" x 40"	7 lbs	59.99

Please see page 176 for Sunbrella Fabrics

**Storage Cover Accessories**

**R & W Accessory Cord**

Features high strength, low stretch and excellent durability. Ideal for leech lines, flag halyards and tie-downs.



Item	Description	Ship	Net
001884	Polyester accessory cord, 1/8", 50' L, White	1 lbs	\$5.99
001885	Polyester accessory cord, 5/32", 50' L, White	1 lbs	5.99

**POLYPROPYLENE BY THE FOOT**

Item	Model	Description	Ship/ft	Net/ft
756941	14600PP	1/4", Yellow, floats and stores wet	1 lbs	\$0.13
	38600PP	3/8", Yellow, floats and stores wet	1 lbs	0.20
	12600PP	1/2", Yellow, floats and stores wet	1 lbs	0.33



**Robline Orion 500 Polyester Rope**

- Combines a woven 16-plait polyester sheathing over an 8-plait core.
- Soft with excellent handling properties
- High UV resistance and stability
- Available in Black, Blue or Red for easy identification on board



Item	Diameter	Length	Average Tensile Strength	Ship/Ft	Net
600599	2 mm	30 m Spool	154 lbs	1 lbs	\$13.99
600600	3 mm	15 m Spool	330 lbs	1 lbs	13.99

**Crystal Clear 20/20 by Strataglass**

This double polished, clear, transparent, flexible vinyl is made of high grade, durable vinyl and is water glass clear.

- Note: Single polished vinyl is transparent, but may have some slight optical imperfections
- Application: Biminis, dodgers, fly bridge enclosures, outdoor covers
- Sold by the roll (110" length)



Item	Gauge	Dimensions	Ship	Net/Yd.
303141	40 gauge	54" W x 110" L	13 lbs	\$124.99



Some manufacturers set M.A.P. (Minimum Advertised Pricing) for their products, so we cannot advertise a lower price. However, this does not always apply to selling price. The actual price you will be charged is probably lower. Please call us at 800-628-8225 for further details.

**Sunshades**

**Taylor Made AnchorShade® III**

- Larger diameter, solid fiberglass structural ribs
- Hinge connectors are twice as strong as on the AnchorShade II

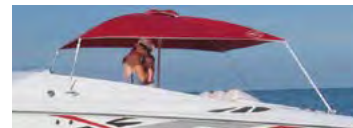

- Powder-coated aluminum frame
- 4-point locking height adjuster
- Sur-Lock push-up mechanism
- 6' x 6' square umbrella can be used on almost any vessel - from a small fishing boat to the larger high performance boats
- Designed to be used when anchored or at idle speed on a calm day
- Adjustable pole locks in place up to 8 feet high
- Lightweight, mildew/fade resistant UV-treated nylon top
- Excellent sun protection that blocks out 85-90% of harmful rays
- Adjustable straps with non-corrosive hardware for mounting flexibility
- "Market Style" top allows venting to occur without loss of sun protection

Please Specify Color: Black, Blue, Burgundy, Forest Green, Gray, Navy, Red, Sand, Teal or White

Item	Description	Ship	Net
102053	6' x 6' Anchor shade	9 lbs	\$123.99

**Taylor Made T-Top Bow Shade**

A quick and easy way to gain additional shaded area on your center console boat is with a T-top installed.



- Shade is available in sizes to accommodate boats up to 102" wide and extends out to 7 ft. of coverage
- Made of Hot Shot™ marine grade polyester fabric, this top is strong, yet lightweight
- Secured to the T-Top and bow rails with adjustable straps and quick release buckles
- Shade folds down to compact size for convenient storage and is available in many colors

Please Specify Color: Navy Blue, Black, Pacific Blue, Cranberry, Sand, Teal, Gray, Hunter, White

Item	Length	Boat Size	Ship	Net
102047	6' L x 90" W	17' - 21'	3 lbs	\$114.99
102048	7' L x 102" W	23' - 26'	3 lbs	138.99

**Awning Pole**

**Forespar Adjustable Awning Pole - Standard and Heavy Duty**

- Ideal for boat awnings
- "Eye" type end fittings
- Includes renowned Forespar internal twist lock mechanism
- Standard size poles have 7/8" and 1" diameter tubing
- Heavy duty poles are 1" and 1-1/8" diameter tubing
- Tubing material: Aluminum (Milspec and clear anodized for corrosion resistance)
- End fittings are polycarbonate



Item	Model	Telescopes	Diameter	Ship	Net
100999	503000	45" to 71"	7/8" / 1"	2 lbs	\$68.99
	504000	57" to 96"	7/8" / 1"	2 lbs	74.99
	505000	69" to 120"	7/8" / 1"	2 lbs	85.99
	506000	81" to 144"	7/8" / 1"	2 lbs	94.99
	505100*	69" to 120"	1" / 1-1/8"	3 lbs	102.99
	506100*	81" to 144"	1" / 1-1/8"	3 lbs	110.99

\* Heavy duty model

**Headliner**

**NAUTOLEX MARINE CABIN TOPPING & BENCH SEAT UPHOLSTERY CLOTH**

Famous NAUTOLEX fabric for cabin tops, bench seats and other upholstery uses where durability is desired. Highest quality for outdoor use.

Item	Model	Color	Width	Ship/Yard	Net/Yard
753035	313041CC	White	54"	2 lbs /yd.	\$9.99

**PERFORATED HEADLINER MATERIAL** Famous headliner material has symmetrically designed pin-point perforations in vinyl coated cotton to allow complete circulation throughout and behind to prevent mildew and decay. For interior use only.

Item	Width	Color	Ship/Yard	Net/Yard
756193	54", 8.6 oz.	White	1 lbs	\$14.99
756195	54", 14 oz.	Cream	2 lbs	15.99

**FOAM BACKED HEADLINER**

- 54" wide with foam backing
- Flame-laminated to mildew resistant polyester foam
- Foam meets MVSS 302 flammability
- All ship 2 lbs/yd.

Non-Perforated	Item	Model	Color	Net/Yard
White	754742	NA6845F	Non-perforated White	\$28.99
	754743	EV134	Perforated White	26.99



## Bird Deterrents

### Bird-B-Gone Deterrents and Accessories

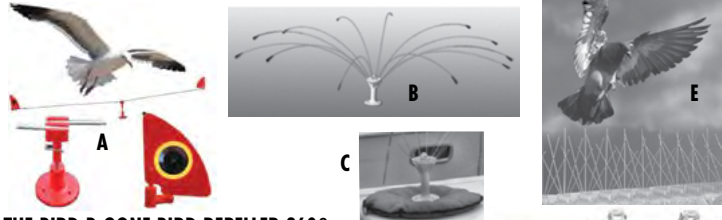

#### THE BIRD-B-GONE BIRD REPELLER 360°

Helps eliminate unsightly messes and stains caused by bird feces.

- Wind powered: No electricity needed
- Will not blow off in heavy winds
- Covers areas up to 6 ft. in diameter
- Reflective "Predator Eyes" on the "Sails" to confuse and scare birds
- Spins continuously to prevent birds from landing
- Variety of mounting bases available
- Made in the USA by Bird-B-Gone, Inc.

**BIRD SPIDER** – The Bird Spider's "arms" bounce and sway in the wind creating a visual distraction zone; birds will not want to come near the area being treated.

**BIRD CHASE SUPER SONIC**–The Bird Chase Super Sonic features distress and predator calls of over 22 types of birds. These sounds are played every ten minutes to alert birds of danger. Area of coverage is up to 1 acre.

**POLYCARBONATE HAWK DECAY**– Birds avoid the area when they see the decoy.

**BASE RAIL MOUNT** – for Repeller 360 and bird spiders. Attach to boat rails and other areas.

Item	Model	Description	Ship	Net
A.	755974	MMRPL360 Bird Repeller 360°	1 lbs	\$37.99
B.	756566	BS400SPN 4' Bird Spider	1 lbs	36.99
B.		BS600SPN 6' Bird Spider	1 lbs	42.99
B.		BS800SPN 8' Bird Spider	1 lbs	46.99
C.	755820	MMBSBB-SB Sand bag base for bird spider	8 lbs	36.99
D.	755821	MMBSBB2 Bird Spider boat base	1 lbs	8.99
E.	755825	MM2001-5/6 Bird spikes	2 lbs	20.99
F.	755824	MMIB50 Bird Chase Super Sonic	4 lbs	108.99
G.	756568	RTH1 Hawk decoy, 6.5" W x 6.5" D x 16" H	1 lbs	12.99
H.	756567	MMRLMNT Railing mount for Bird Spiders and repellents	1 lbs	14.99

### Bird-B-Gone Plastic Spike Strip

- Polycarbonate Bird Spikes are an effective, humane solution for deterring large birds from landing in unwanted areas
- Birds cannot land on the un-even surface created by the spikes and will move on
- 1.5" wide base can be glued, screwed or tied to most surfaces
- Will not harm birds
- Virtually Invisible
- GSA Approved
- Glue trough on base of spike allows for fast and easy application
- Will not interfere with electrical or communication and transmissions
- U.V. protected / sun and weather proof
- 5 Year Warranty
- Made in the USA



Item	Model	Description	Ship	Net
756297	MM2000-5/6	5"H x 6' L	2 lbs	\$18.99
756298	MM2000-5/20	5"H x 20' L	5 lbs	47.99

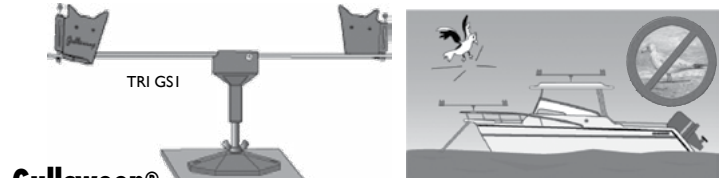

### Gullsweep®

Gullsweep keeps anchored boats free from gulls by continuously sweeping the area where they are inclined to land. Support arms are bright, anodized aluminum and are very resistant to the effects of salt water. The slightest breeze rotates the sweep which has been tested at wind velocities in excess of 60 mph with no adverse effects.

- Eliminates cleaning time and unsightly stains
- Easily mounts on hard or soft topped boats
- Folds in half and stows away quickly
- Doesn't require any on-board power
- Sweeps a full 6' diameter and intimidates birds with its movement

Item	Model	Description	Ship	Net
755172	GSI	Gull Sweep	1 lbs	\$42.99
755558	GS-FM	Flex mount (Non-permanent)	4 lbs	30.99
755513	GS-RM	Rail mount (Fits up to 1-5/8" diameter rail)	1 lbs	30.99

Note: Do not run boat with Gullsweep in place.

## Boat Hooks

### ROBSHIP HOOK & MOOR BOAT HOOK

- Helps to easily thread a mooring rope through a mooring ring
- Type: Telescopic
- Aluminum/Black

Item	Model	Extends	Ship	Net
002053	708-8980-5	3.7' to 9.8'	4 lbs	\$139.99
002052	708-8980-4	3.6' to 6.6'	3 lbs	119.99



### STAR BRITE HEAVY DUTY EXTENDING HANDLE

- Lightweight and incredibly strong
- Special air chambers make it float
- Includes (2) non-slip hand grips and positive twist lock
- Handle material: Triple anodized aluminum

Item	Model	Extends	Ship	Net
754258	40155	3' to 6'	1 lbs	\$28.99

### STAR BRITE EXTENDING ECONOMY BOAT HOOK

- Telescoping pole extends with a special fast locking cam action
- The boat hook is made of unbreakable glass reinforced nylon
- Special air chambers make it float!

Item	Model	Extends	Ship	Net
755523	40609	4' to 8'	2 lbs	\$24.99

### DAVIS FLOATING TELESCOPING BOAT HOOKS

MADE IN THE USA!

- A useful tool on any boat for docking, launching, mooring, rafting and retrieval
- Aluminum poles with Lexan ends (Manufacturer's lifetime warranty on Lexan ends)

Item	Model	Length	Ship	Net
450659	4122	4'5" to 8', 2-section	1 lbs	\$27.99
450660	4132	3'2" to 8', 3-section	2 lbs	34.99
450661	4152	4'6" to 12', 3-section	2 lbs	39.99

Note: End has 3/4" acme thread to accept deck brushes, mops, etc.

## TACO METALS TACO Universal Rub Rail Kits

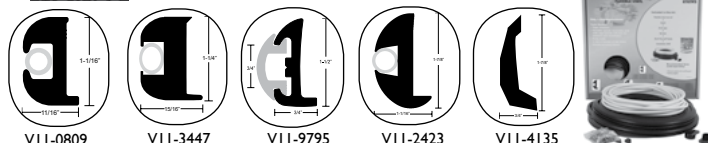

Kit includes: • Vinyl rub rail • Insert (If needed) • End caps (Where applicable) • Screws • Installation guide (Downloadable)

### FLEXIBLE RUB RAIL KITS

Item	Model	Height	Width	Lgth	RR/Ins.	Ship	Net
003337	V11-0809BBK50-2	1-1/16"	11/16"	50'	Blk/Blk	18 lbs	\$169.99
003337	V11-0809BBK70-2	1-1/16"	11/16"	70'	Blk/Blk	25 lbs	195.99
000214	V11-0809BWK50-2	1-1/16"	11/16"	50'	Blk/Wht	18 lbs	190.99
000950	V11-3447BWK50-2	1-1/4"	15/16"	50'	Blk/Wht	26 lbs	229.99
003338	V11-3447BBK50-2	1-1/4"	15/16"	50'	Blk/Blk	26 lbs	224.99
003338	V11-3447BBK70-2	1-1/4"	15/16"	70'	Blk/Blk	35 lbs	289.99
000219	V11-3447WVK50-2	1-1/4"	15/16"	50'	Wht/Wht	28 lbs	278.99
003339	V11-2423BWK50-2	1-7/8"	1-1/16"	50'	Blk/Wht	43 lbs	319.99
003339	V11-2423BWK70-2	1-7/8"	1-1/16"	70'	Blk/Blk	58 lbs	401.99
003340	V11-2423BBK50-2	1-7/8"	1-1/16"	50'	Blk/Blk	43 lbs	319.99
003340	V11-2423BBK70-2	1-7/8"	1-1/16"	70'	Blk/Blk	58 lbs	401.99

### SEMI-RIGID RUB RAIL KITS

000221	V11-9795BBK50D-2	1-1/2"	3/4"	50'	Blk/Blk	28 lbs	\$257.99
000227	V11-4135BKA30-3	1-7/8"	3/4"	30'	Blk/NA	14 lbs	185.99

### TACO V11-3426 FLEXIBLE VINYL RUB RAIL KIT- 50'

- Made of the highest quality vinyl compounds
- Black with Black insert
- Resistant to sun and salt damage
- 1-7/8" H x 1-3/8" W at center

Item	Model	Ship	Net
000952	V11-3426BBK50-2	43lbs	\$349.99

### TACO SEMI-RIGID VINYL WITH A CHROME INSERT

- Flexible, durable and packaged in continuous coils
- One-piece installation without seams
- White with flexible chrome insert
- 1-5/8" H x 3/4" W x 70' L

Item	Model	Ship	Net
755814	V11-9811WCM70-2	30 lbs	\$389.99

### TACO STAINLESS STEEL RUB STRAKE

- Designed to prevent chafing of dock, fender and anchor lines
- Ideal for yachts and larger boats with heavy lines

Width: 3/4" Please Specify Length: 8", 12", 18" or 24"

Item	Size	Ship	Starting at
002495	3/4" Wide	1 lbs	\$13.99

### TACO MARINE FLEXIBLE VINYL TRIM

- Dimensions: 5/8" trim, 3/8" opening, Length: 25'
- Conforms to almost any bend radius without heating
- Internal aluminum clips and gripping tongue

Item	Color	Ship	Net
001829	Black	3 lbs	\$48.99

## Cockpit Tables

### SeaTeak Teak Cockpit Table with Four Drink Holder



60392

- Solid teak with brass hinges and stainless steel hardware
- No drilling of pedestal guard required for installation
- Mounting hardware is NOT included to allow for custom installation
- Holds 4 glasses or 2 glasses and a pair of binoculars
- Fold-down support leg 30-1/2" long
- Fits all 3/4", 1", or 1-1/4" pedestal steering guards
- Entire unit is removable for storage

**WITH FOLDING LEAVES AND (4) DRINK HOLDER** - (2) Brass barrel bolts and (2) clamps included.

Item	Model	Size	Ship	Net
401284	60392	32"H x 15.75"W x 31"D when open 32"W with leaves expanded	21 lbs	\$369.90

**REMOVABLE TABLETOP** - In the down position, tabletop hangs on hooks and secures to the pedestal guard with clips

401303	61394	16"W x 24"L	10 lbs	\$297.99
--------	-------	-------------	--------	----------



61394



61394

### SEASTOW RAIL CLAMPS

- No drilling required for installation
- (2) Clamps per package

Item	Model	Fits Railing	Ship	Net
755952	72669	3/4", 1", or 1-1/4"	1 lbs	\$31.99

### Edson Fold Down Drop Leaf Tables

Increase the versatility of your pedestal and turn your cockpit into a social center and dining area. Fold down and clip against the guard when not in use. Simply swing the table up and clip the formed wire brackets into place when ready to use. When the leaves are closed, you have a 26" L x 15" W table with fiddle rails. Now available for 1", 1-1/8" and 1-1/4" guard pipes or for console-style pedestal mount.

#### WHITE POLY DROP LEAF TABLES

Item	Model	Description	Open Dimensions	Ship	Net
650234	737WH-95-28	For 9-1/2" guards 1", 1-1/8" or 1-1/4"	26" x 30"	30 lbs	\$706.99
600630	737WH-C-28	Console Mount	26" x 30"	30 lbs	729.99



737WH-95-28

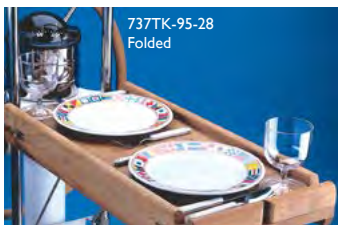

737TK-95-28  
Folded

#### SOLID TEAK DROP LEAF TABLES

Item	Model	Description	Open Dimensions	Ship	Net
650233	737TK-95-28	For 9-1/2" guards 1", 1-1/8" or 1-1/4"	26" x 27"	19 lbs	1161.99
400777	737TK-C-28	Console Mount	26" x 27"	21 lbs	1183.99



761WH-95-28  
Drink holder not included.

#### COCKPIT TABLE HARDWARE KIT - for Edson models 761 and 784

Stainless steel hardware only kit for do-it-yourselfers.

Item	Model	Description	Ship	Net
650225	785-761-95	For 9-1/2" guards - 1", 1-1/8" or 1-1/4"	3 lbs	\$215.99

#### FOLD-DOWN LUNCHEON TABLE - White marine-grade polyethylene • Measures 13-1/2" x 24"

650235	761WH-95-28	For 9-1/2" guards - 1", 1-1/8" or 1-1/4"	15 lbs	423.99
--------	-------------	------------------------------------------	--------	--------

### Lewmar Whitlock Solid Teak Table With Double Leaf

- When not in use, can be folded up against pedestal
- Stowing and unclipping is easy with the quick release hinge pin
- Unvarnished



89400284

Item	Model	Fits	Ship	Net
400592	89400284	Enguard pedestal	13 lbs	\$669.99
401448	89400283	Classic pedestal	16 lbs	1262.99

Note: includes bracket, support and instructions

## Drink Holders

### Edson Pedestal Guard Mount Drink Holders



878WH-2-125

- Attach to your guard pipe to provide a convenient location for cans, mugs, cups, etc.
- Cast 316 stainless steel with teak or White poly base
- UV inhibitors guard against sun damage
- Clamp on model allows unlimited rotation for angled guards
- Fits 1", 1-1/8" and 1-1/4" guard pipes



878TK-2-125

Item	Model	Description	Ship	Net
400771	878WH-2-125	Double White poly - clamp on	3 lbs	\$166.99
400772	878TK-2-125	Double teak - clamp on	2 lbs	189.99

### Edson Stainless Steel Drink Holders



878ST-3

- Ideal for mounting to a flat surface
- Designed to fit Koozies, cans, mugs or large cups up to 3-3/8" in diameter

- Features an open frame to accommodate coffee cup handles
- Sits 3" high when installed and made of highly polished 316 stainless steel
- Includes threaded stud for mounting and locator pin to keep from rotating
- Rubber gasket, washer and nut included

Item	Model	Description	Ship	Net
600682	878ST-1	Single with stud and pin for mounting	1 lbs	\$32.99
600683	878ST-2	Double with stud and pin for mounting	1 lbs	43.99
613086	878ST-3	Triple with stud and pin for mounting	2 lbs	62.99
400770	878ST-IV	Single - vertical bulkhead mount (not shown)	1 lbs	40.99

## Coolers

### IGLOO® Marine Ultra Coolers



44687

- Ultratherm® insulated cooler body and lid
- Stain and odor-resistant liner
- UV inhibitors guard against sun damage
- Threaded plug for hose hook up
- Reinforced non-slip, comfort grip swing up handles with tie-down feature
- Most units have fish keeper measuring tool on lid
- Snaps for attaching optional seat cushion

Item	Model	Quarts	Exterior L x W x H	Ship	Net
401167	44679	36	24" x 13.56" x 13"	7 lbs	\$49.99
401168	44681	48	26.08" x 14.63" x 14.5"	9 lbs	57.99
D 401169	44683	54	26.38" x 15.5" x 15.5"	29 lbs	63.99
D 401170	44685	72	30.06" x 16.5" x 16.13"	39 lbs	115.99
D 401171	44687	94	35.01" x 16.75" x 17.63"	56 lbs	169.99

### Kuuma Coolers

The Kuuma cooler is a rotomolded, one-piece cooler, which means it won't crack or break. The sealing gasket keeps the cool air in and the hot air out.

- Thick, seamless walls which means more insulation and longer ice retention
- Extremely durable
- Bolt-through lid hinges



58363

Item	Model	Features	Capacity	Ship	Net
402511	58367	2" built-in drain with handle	21 quarts	13 lbs	\$162.99
D 402512	58361	2" built-in drain	37 quarts	31 lbs	219.99
D 402513	58363	2" built-in drain	58 quarts	43 lbs	244.99
D 402514	58365	2" built-in drain	105 quarts	93 lbs	309.99

FOR ADDITIONAL CUSHIONS AND ACCESSORIES PLEASE VISIT WWW.DEFENDER.COM



Kuuma coolers available at  
www.defender.com or call 800-628-8225.



## Tables, Tabletops, Packages & Hardware

### A. GARELICK FOLDING DECK TABLES

- Thermofused, watertight White melamine top is permanently bonded to core on both sides
- Edge is finished with molded sea lip
- Rugged 7/8" diameter aluminum legs with plastic tips

Item	Size	Ship	Net
400604	16" x 32" (21.5" H)	14 lbs	\$139.99
400605	24" dia. (16" H)	13 lbs	104.99

### B. EUDE NAUTIC STAR FOLDING TEAK TABLE TOPS

- Original caulked tabletop with compass rose design
- Constructed from 5/8", 100% plantation teak

#### Folding

Item	Description/W cm x L cm	Ship	Net
650966	Oval, 60.3 (23.74") x 93.5 (36.81")	18 lbs	\$365.99
650814	Rectangular with (2) leaves, 67.8 (26.69") x 80 (31.50")	18 lbs	339.99

#### Standard

650811	Soft rectangle, 51.5 (20.28") x 75 (29.53")	9 lbs	209.99
650812	Half ellipse, 60.5 (23.82") x 93.4 (36.77")	12 lbs	279.99
650813	Soft rectangle, 37.4 (14.72") x 60 (23.62")	6 lbs	179.99
650815	Half ellipse, 50 (19.69") x 70 (27.56")	9 lbs	220.99
650816	Octagonal, 55 (21.65") x 55 (21.65")	7 lbs	169.99
650963	Rectangle (plain: no star design) 48.3 (19.02") x 76.8 (30.24")	8 lbs	124.99

### C. NORSAP POLISHED ALUMINUM TABLE PEDESTALS

- All pedestals are 360° swivel top and include base plate

Item	Description	Ship	Net
650561	Pedestal; spring loaded adjustable, 16.5" - 26.8", 3.1" tube	16 lbs	\$499.99
650562	Pedestal; gas assisted adjustable, 16.5" - 26.8", 3.1" tube	16 lbs	599.99
650565	Pedestal; manually adjustable, 18.3" - 26.8, 2.6" tube	5 lbs	189.99
650563	Pedestal; 28.5" fixed height, tube 2"	4 lbs	129.99
650566	Stainless steel 5.9" base plate and extra deck mount	1 lbs	58.99

### D. SEATEAK TEAK FOLDING DECK TABLE

- Machine cut allows for a precise fit and finish
- Each piece is hand sanded and finished with teak oil
- Solid brass hardware

Item	Model	Description	Ship	Net
650732	60030	20" x 20" Square	15 lbs	\$115.99

### E. TODD ROUND TABLETOP PACKAGE

- Rugged polyethylene; includes (4) cup holders
- Package includes top, mounts and 26" Posi-Lock table post and floor plate (recesses into deck/floor)
- Hardware attaches to molded-in holes on underside
- White tabletop is 21-1/2" diameter

Item	Description	Ship	Net
401243	Tabletop Posi-Lock package	12 lbs	\$133.99
401242	Round tabletop only	8 lbs	63.99

### F. TODD OVAL TABLETOP PUSH/PULL PACKAGE

- Rugged polyethylene; includes (4) cup holders
- Package includes top, mounts and 26" push/pull table post and floor plate (recesses into deck/floor)
- White tabletop is 30" L x 18" W

Item	Description	Ship	Net
401234	Tabletop push/pull package	12 lbs	\$125.99
401235	Tabletop Posi-Lock package	12 lbs	135.99

### TODD TABLE HARDWARE

Item	Description	Ship	Net
401244	Seat/table pedestal, 15"H, flush mount	5 lbs	\$143.99
401245	Seat/table pedestal; adjustable 14-20" H, flush mount	7 lbs	219.99
401246	Pedestal base, 9-3/8"; flush mount	5 lbs	258.99
401236*	Posi-Lock post; anodized alum.	2 lbs	41.99
401237	Posi-Lock square floor plate 6" W x 6" L x 2.25" D; center hole 2.25" D	2 lbs	48.99
401238	Standard round table plate push/pull; 7-1/2"	2 lbs	36.99
401239	Floor plate plug; 2" for center of square floor plate	1 lbs	4.99
401240	Replacement caps (2) 2"; Posi-Lock	1 lbs	27.99
401241	Replacement caps (2) 2"; Push/pull	1 lbs	25.99

\*Comes in 5 sizes from 26" to 30"- please select size when ordering.



## Deck Chairs/Portable Chairs/Chair Tips/Covers

### G. GARELICK ORIGINAL HIGH BACK CHAIR

- Lightweight aluminum compact folding frame - riveted
- Clear satin anodized finish to resist corrosion
- Double leg design with front cross bar frame for added stability - poly tips
- Frame provides back support and comfortable seating
- Durable UV resistant sewn woven fabric
- Real varnished hardwood arms

Specify color: Navy Blue or Black

Item	Dimensions	Ship	Net
651013	16" Seat height x 24" High back	16 lbs	\$89.99

### H. WISE FOLDING DECK CHAIR

- Weather-resistant, 28 oz., White, marine-grade vinyl
- High-density foam cushions are resilient and firm
- All hardware is zinc plated • 8 legs for added strength
- Constructed of sturdy, thick, anodized aluminum
- Height: 30" Width: 26" Depth: 24"

Item	Model	Ship	Net
650899	WD120AB710	47 lbs	\$174.99

### I. SPRINGFIELD CLASSIC FOLDING DECK CHAIR

- High-density foam cushions covered with White, marine-grade, mildew resistant vinyl
- Folds flat for compact storage
- Overall dimensions: 30" H x 24" D x 25" W

Item	Tubing	Color	Ship	Net
650760	Aluminum	White	59 lbs	\$181.99
650761	Stainless steel	White	61 lbs	249.99

### J. GARELICK DESIGNER PADDED DECK CHAIR

- One piece canvas back - 24" high
- 1" padded back and thigh support for lumbar comfort
- Double leg and front cross bar frame
- Sewn olefin fabric with embroidered code flag and trim
- 1" diameter, corrosive resistant, folding, anodized aluminum frame with poly tips
- Varnished hardwood arms

Color: Navy

Item	Model	Seat Height"	Ship	Net
402150	35029	16"	24 lbs	\$94.99

### K. TELESCOPE CASUAL DIRECTOR CHAIRS

- Solid North American hardwood
- Chairs fold compactly
- Corner bracing ensures long term rigidity
- Arms are shaped/sanded for comfort and smoothness

Note: Canvas seat cover not included on telescope chairs

Telescope Casual Director chair canvas covers

Specify color: Red, White, Brown, Green, Navy, Blue, Black, Canary, Natural, Forest Green or Burgundy

Item	Ship	Net
650869	1 lbs	\$28.99

### L. SEATEAK DIRECTOR CHAIRS

- 100% Solid teak with stainless steel hardware
- Folds easily for storage
- DURASLING fabric seat and back

Item	Model	Dims (HxWxD)	Ship	Net
650976	60067	34.5" x 23.5" x 20.5"	37 lbs	\$219.99

### M. TAYLOR MADE DECK CHAIR COVERS

Protect your deck chairs from sun and wind damage. Elastic fitted bottoms and reinforced air vents allow moisture to escape. Size: 29 H" x 26 W" x 29.5 D"

Item	Model	Color/Fabric	Ship	Net
650495	40235	White vinyl	3 lbs	\$29.99
650496	80235	Blue rip/stop polyester	3 lbs	39.99

### N. TAYLOR MADE RUBBER CHAIR TIPS

Non-marking rubber tips are great for use on deck chairs, boarding ladders, boat hooks, etc. Sold in packages of 4 tips.

Item	Tubing	Color	Ship	Net
400782	7/8"	White	1 lbs	\$7.99
400783	1"	White	1 lbs	7.99

### O. GARELICK PREMIUM DOUBLE LEG REPLACEMENT CHAIR TIPS

- White plastic tips for 1" double leg tubing
- Package of (2)

Item	Tubing	Color	Ship	Net
402213	1"	White	1 lbs	\$10.99

Back by request of recreational boaters and those in the trade that originally sold them!





**Helm Seats/Helm Packages**

**A. TODD POINT LOMA SEAT**

Here is a great choice for the boater who needs side entrance access to his boat seat. The Loma seat is constructed with molded-in, double handgrips and top quality, removable cushions.

Item	Model	Description	Ship	Net
D 655340	10-0106C	Seat and cushion	41 lbs	\$151.99
D 650763	0106-SP	Complete package	41 lbs	246.99

**B. TODD FREEPORT HELM SEAT**

The world's best selling saltwater boat seat, the Freeport is a great looking chair that features lasting quality and is designed for economy-minded boaters. This seat is a solid pick for fishing or cruising.

Item	Model	Description	Ship	Net
D 655341	971537-LC	Seat and cushion	41 lbs	\$146.99
D 650764	7800	Complete package	41 lbs	272.99

**C. TODD CHESAPEAKE HELM SEAT**

Impervious to harsh saltwater use, the Chesapeake promises many seasons of uncompromised service. Ample and attractive, this chair is everything a boater looks for in seating.

Item	Model	Description	Ship	Net
D 655336	85-1538C	Seat and cushion	40 lbs	\$193.99

**D. TODD JUPITER HELM SEAT**

An excellent upgrade from existing seats (includes cushions) Marine-grade vinyl covered foam cushions – removable

Item	Model	Description	Ship	Net
D 401220	95-4500C	Seat and cushions	44 lbs	\$198.99
D 401221	7450	Complete package	44 lbs	298.99

**E. TODD CAPE COD HELM SEAT**

A favorite among boaters for years, this classic seat affords good looks and extreme comfort.

Item	Model	Description	Ship	Net
D 655335	85-1556C	Seat and cushion	62 lbs	\$225.99
D 650457	7050-15	Complete package	62 lbs	367.99

**F. TODD HATTERAS LADDERBACK SEAT**

Ultra-low maintenance • One piece molded design • Extra heavy duty components • Ideal for saltwater use

Item	Model	Description	Ship	Net
D 655339	40-1050C	Seat and cushion	71 lbs	\$345.99

**G. TODD GLOUCESTER COMPANION LADDERBACK SEAT**

A classic – matches the Gloucester Captain's Seat (with arms) Includes tufted, removable cushions of the highest quality

Item	Model	Description	Ship	Net
D 401223	94-1500DCMP	Seat (no arms)	71 lbs	\$382.99
D 650903	1500-01D	Complete package	71 lbs	608.99

Use Garelick Easy Mount Swivel on page 185.

**H. THE NEWPORT PACKAGE BY SPRINGFIELD**

Seat, cushions, swivel and fixed pedestal with base 9" diameter diamond tip polished base; bright anodized post

Item	Model	Color	Ship	Net
D 302576	1060100	White	57 lbs	\$184.99

**I. TODD CABO SUPREME SEAT PACKAGE**

Seat, elite slider, seat/arm cushions and pedestal (backrest cushion not included - sold below)

Item	Model	Description	Ship	Net
D 650914	97-2199WPK	Seat package	114 lbs	\$519.99

**Optional Backrest cushion**

Item	Model	Description	Ship	Net
401253	3701	White cushion	2 lbs	\$94.99

**J. TODD CAPE MAY HELM SEAT**

A timeless ladderback helm chair with rich mahogany slats Includes integrated molded arm rests and cushions

Item	Model	Description	Ship	Net
D 401229	89-2032C	Seat and cushions	68 lbs	\$409.99

**K. TODD GLOUCESTER CAPTAIN'S SEAT**

The Gloucester has tufted removable cushions of the highest quality in its class. The back is made from starboard supported by heavy anodized aluminum brackets.

Item	Model	Description	Ship	Net
D 655338	94-1500D	Seat and cushion	58 lbs	\$456.99

**L. TODD 5-STAR HELM SEAT**

Todd's premier seat has extra thick upholstery, swing away arms, individual lumbar support cushions and an integrated headrest.

Item	Model	Description	Ship	Net
D 401215	U9705WH	White	109 lbs	\$1002.99
D 401214	U9705BK	Black	109 lbs	1002.99

**M. TODD 5 STAR HELM SEAT WITH FLIP-UP BOLSTER**

Flip up bolster for use as seat or leaning post Individual lumbar support and an integrated headrest

Item	Model	Color	Ship	Net
D 401216	U9705BK-FB	Black	112 lbs	\$1536.99
D 401217	U9705WH-FB	White	112 lbs	1536.99

**N. TEMPRESS CAPTAIN'S SERIES ELITE HIGH & LOW BACK**

The helm seat is constructed of materials designed to withstand the rigors of the marine environment.

Item	Model	H" x W" x D"	Ship	Net
D 650492	High Back	26 x 23-1/2 x 27-1/2	76 lbs	\$234.99
D 650493	Low Back	22 x 23-1/2 x 27-1/2	76 lbs	224.99

CHOOSE A PEDESTAL FROM THE HARDWARE SECTION ON PAGE 185

**O. SPRINGFIELD LADDER BACK CHAIR PACKAGE**

Tough marine grade vinyl cushions Padded armrests on anodized polished aluminum arm brackets

Item	Model	Description	Ship	Net
D 651014	1001303	Seat and cushions	97 lbs	\$369.99

**P. THE YACHTSMAN PACKAGE BY SPRINGFIELD**

Seat, cushions, slider, swivel and fixed pedestal with base 9" diameter heavy-duty anodized aluminum base

Item	Model	Color	Ship	Net
D 302577	1001414-L	White	55 lbs	\$204.99
650961	(1)	Seat and (1) Back cushion	4 lbs	46.99

**Q. SPRINGFIELD DELUXE CAPTAIN'S SEAT PACKAGE**

Includes: Cushions, camlock slide & swivel with 18" fixed pedestal

Item	Model	Color	Ship	Net
651066	1040002PKG	White	75 lbs	\$309.99



## Leaning Posts

### A. TODD SINGLE PORTABLE LEANING POST

- Slides over existing 2-7/8" pedestal; quickly replaces seat
- Storage compartment
- Easily attached and removed from existing pedestal
- Seat full height with pedestal: 32-1/4"

Item	Model	Color	Ship	Net
D 401222	902200SP	White	41 lbs	\$340.99

### B. TACO NEPTUNE II LEANING POST and Accessories

Ideal for small to medium sized center console boats.

- Easy DIY installation
- White cushions
- Corrosion resistant anodized aluminum
- (4) adjustable angle aluminum rod holders
- Room for 72 qt. cooler

#### Leaning Post - Adjustable Rod Holders w/Softpack Storage

Item	Model	Ship	Net
D 402017	L10-1003-I	70 lbs	\$989.99

#### Leaning Post - With Rod Holders w/Fiberglass Storage

Item	Model	Ship	Net
D 401428	L10-1001-I	80 lbs	\$1199.99

#### Neptune Series Leaning Post Backrest Only

Item	Model	Ship	Net
650221	L10-1002-I	9 lbs	\$209.99

### C. TODD LEANING POST

- Designed to function as a leaning post or seat
- Color: White

Item	Model	Description	Ship	Net
401209	2200-35	Adjustable: 26"-32"	93 lbs	\$718.99
D 401210	2200-50SA	Fixed height: 11"	95 lbs	734.99
D 401211	2201	Backrest only	43 lbs	241.99

### D. TACO NEPTUNE III LEANING POST

- Aluminum frame; spiral sanded; bright dipped anodized
- One-piece welded frame construction made from marine-grade aluminum
- Seat cushions constructed with marine-grade vinyl, foam and PVC board substrate

#### Leaning Post with White Upholstery and (4) Poly Rod Holders

Item	Model	Ship	Net
D 401429	L10-2005BSA-I	107 lbs	\$720.99

#### Deluxe Leaning Post with White Upholstery, Backrest, Grabrail and (4) Aluminum Rod Holders

Item	Model	Ship	Net
D 401430	L10-2010BSA-I	164 lbs	\$1199.99

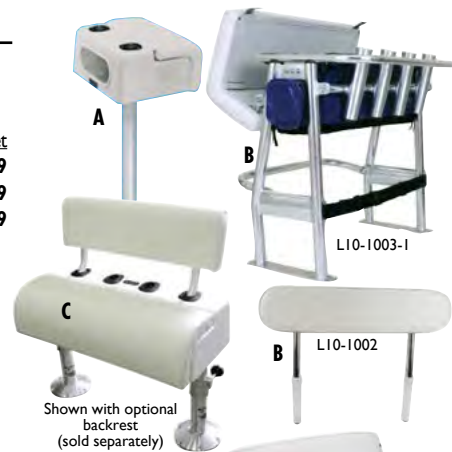

Shown with optional backrest (sold separately)

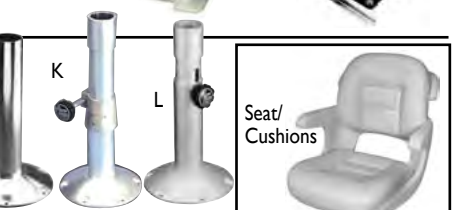
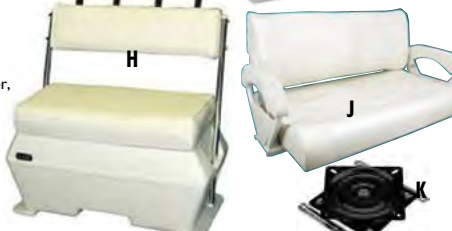

## Swing Backs/Lounge Chair/Chairs with Bases

### E. TODD SWINGBACK SEAT

- Insulated cooler/livewell
- Capacity: 50 quarts
- White marine grade vinyl bottom and back cushions included
- Double-wall, foam insulated interior with rounded corners
- Includes a drain fitting

Outside dimensions: 18" D x 35-1/2" W x 19" H

Item	Model	Description	Ship	Net
D 401224	1758-18A	Aluminum arms	95 lbs	\$498.99
D 301166	1758-18U	Mahogany arms	95 lbs	471.99
D 401250	(1) Seat and (1) back cushion		45 lbs	209.99

### F. TODD DELUXE SWINGBACK SEAT

- Stainless Steel arms
- Capacity: 70 quarts
- White marine grade vinyl bottom and back cushions included
- Double-wall, foam insulated interior with rounded corners
- Includes a drain fitting, lid has a recessed rubberized gasket for a tight seal

#### Cooler / Livewell, Insulated Seat

Item	Model	D" x W" x H"	Ship	Net
D 301163	1792-18U	17-3/4 x 38 x 20-1/2	95 lbs	\$498.99

#### Dry Storage Seat, Non-Insulated

Item	Model	D" x W" x H"	Ship	Net
D 401225	179218NI	17-3/4 x 38 x 20-1/2	93 lbs	534.99

### G. TEMPRESS HIGH & LOW BACK NAVISTYLE

- A blend of ergonomic craftsmanship, smooth functionality and subtle curves which provide lumbar support
- Tapered sides allow for lateral movements
- "No-pinch" hinge with automatic locking mechanism

#### Please specify color:

White, Red/Gray, White/Blue or Blue/Gray

Item	Model	H" x W" x D"	Ship	Net
301165	High Back	23-1/2 x 18-1/2 x 19-1/2	14 lbs	\$134.99
301164	Low Back	18-3/4 x 18 x 19-1/2	12 lbs	123.99

Use Garelick easy mount swivel at right.

### H. TODD SWINGBACK ANGLER LARGE DELUXE SEAT

- Insulated cooler/livewell
- Capacity: 70 quarts
- Includes Stainless Steel arms, White cushions and rod holders
- Outside dimensions: 17-3/4" D x 38" W x 20-1/2" H

Item	Model	Description	Ship	Net
D 401228	1792-URH	Insulated	104 lbs	\$560.99
D 401226	1792-18NIRH	Non-insulated	95 lbs	560.99

### I. WISE DELUXE LOUNGE SEAT

- Designed to fit most 16' to 19' boats
- UV treated heavy-duty, 26 oz. marine grade vinyl
- Compression foam padding
- Removable seat cushion for storage
- Dimensions: 28" H x 17.5" W x 45.5" L
- Extended length: 64.5"
- 5 Year warranty on frame; 3 year warranty on upholstery.

Item	Model	Color	Ship	Net
650530	WD707P-I	White	63 lbs	\$189.99

### J. SPRINGFIELD DOUBLE BUCKET SEAT

- Unique flip back feature allows fore or aft seating
- Plush foam padding covered with heavy-duty marine vinyl over a high-strength composite substrate
- Designed for use with box, post or pedestal application
- Seat dimensions: 21" H x 41" W x 24" D

Item	Model	Color	Ship	Net
D 650627	1042050	White	148 lbs	\$419.99

An additional \$55.00, Large Package Surcharge Fee, imposed by the carrier, will be included in your shipping charges.

### K. GARELICK EASY MOUNT SWIVEL

Allows your chair to swivel for added agility.

Item	Model	Ship	Net
650520	75018	4 lbs	\$31.99

## Hardware

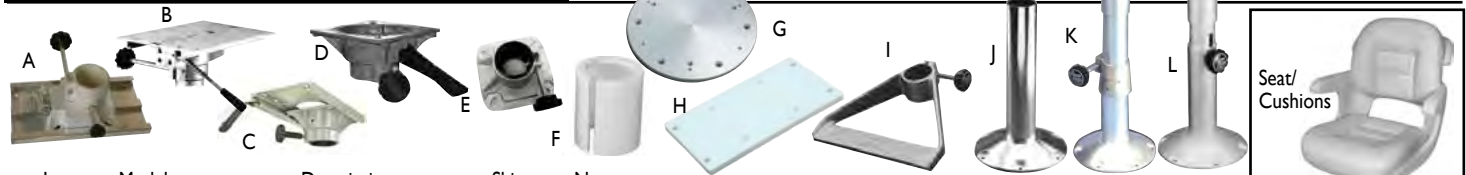

Item	Model	Description	Ship	Net
A. 655334	5201A	Manual super slider; 6 adjustments, 7-1/4" W x 13-1/4" L	5 lbs	\$125.99
B. 650505	6002A	Semi-automatic slider, port or starboard; knob and handle 9-1/2" W x 13-1/8" L	7 lbs	169.99
C. 650626	1100521-I	Springfield Trac-Lock Seat Slide, travels 5-1/4" forward and back on 2-7/8" post	4 lbs	72.99
D. 655343	5203A	Aluminum spider, 360° rotation, fits 2-7/8" pedestals, positive lock and friction knob	3 lbs	76.99
E. 650503	5203-I	Table top spider, 360° rotation, fits 2-7/8" pedestals, friction locking knob, 3" bushing	2 lbs	82.99

Item	Model	Description	Ship	Net
F. 655342	9994-72	Helm seat White bushing slides over the top of a 2-7/8" OD pedestal	1 lbs	17.99
G. 650771	20-1018	Quick release base plate	3 lbs	126.99
H. 650772	5202-P	Polyethylene mounting plate, White	2 lbs	32.99
I. 650501	5205	Foot Rest, 13" W x 10-1/2" L	4 lbs	\$115.99
J. 655350	5312A	12" Height ABYC Class AD	4 lbs	80.99
	5315A	15" Height ABYC Class AD	4 lbs	89.99
	5318A	18" Height ABYC Class AD	6 lbs	87.99
	5330A	30" Height ABYC Class AD	8 lbs	109.99
K. 650685	93-5300	Deluxe adjustable seat pedestal positively locks from 14" to 20"	6 lbs	169.99
L. 650498	5300	14"-20" adjustable height	5 lbs	137.99

Note: All Todd pedestals have 9" base. Outside diameter of all pedestals is 2-7/8".

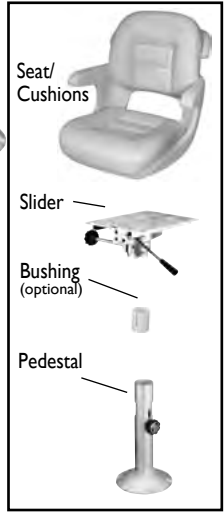



## Taco Outrigger Kits



### Grand Slam 380 Kits

- Fits most 15' outriggers
- Adjust outrigger movements from under the T-Top
- Sleek, ergonomic shape
- Features fold-up elevation crank handle

#### Kit Includes:

(2) OT-0541-15-HD Tele-Outriggers (15' each) (Specify color) • (2) GS-380 Grand Slam 380 outrigger mounts with 30° offset handles • (1) RK-0001PB premium rigging kit (rigs 2 outriggers) • (2) F40-0030BKA-1 Outrigger line caddies

<b>GS-3841VEL</b> Silver/Gold	<b>GS-3841BKA</b> Black/Gold	
<b>GS-3842BKA</b> Black/Silver		
<b>Item</b>	<b>Ship</b>	<b>Net/Pair</b>
<b>350079</b>	49 lbs	<b>\$2649.99</b>

#### TACO GRAND SLAM BACKING PLATES

• 1/4" Anodized aluminum • (2) per package • For all GS-380, GS-280 and GS-170 Grand Slam mounts  
 Item **650999** Model **BP-150BSY-320** Ship 2 lbs Net **\$76.99**



### Grand Slam 280 Outrigger Kit

- For use on 20' to 36' fishing boats
- Fits both hardtop and soft top applications
- Stainless steel and anodized aluminum construction
- (12) locking fishing positions • 4" x 6" mounting base

#### Kit Includes:

(2) OT-0541-15-HD Tele-Outriggers (15' each) (Specify color) • (2) GS-280 Grand Slam 280 outrigger mounts with 30° offset handles • (1) RK-0001PB Premium rigging kit (rigs 2 outriggers) • (2) F40-0030BKA-1 Outrigger line caddies

<b>GS-2841VEL</b> Silver/Gold	
<b>GS-2841BKA</b> Black/Gold	
<b>GS-2842VEL</b> Silver/Silver	
<b>Item</b>	<b>Ship</b>
<b>350080</b>	48 lbs
	<b>Net/Pair</b>
	<b>\$1729.99</b>



### Grand Slam 170 Outrigger Kit

- Bolt-down Grand Slam 170 outrigger base, 1-1/8" O.D.
- Choice of anodized aluminum 15' Silver/Gold or Black/Gold telescoping outriggers
- Complete rigging kit including glass eye on shock cord, Dacron line, release clips and accessories

#### Includes:

GS-170 Top mounts (pair) • Standard rigging kit  
 (2) 15' x 1-1/8" outrigger poles • Outrigger line caddy

**Please specify:** Silver/Gold or Black/Gold outriggers

<b>Item</b>	<b>Model</b>	<b>Ship</b>	<b>Net/Pair</b>
<b>650489</b>	<b>GS-170 Kit</b>	48 lbs	<b>\$1129.99</b>
<b>650831</b>	<b>GS-170-2</b> Center mount base	7 lbs	<b>389.99</b>
<b>650385</b>	<b>RK-0001PB</b> Outrigger rigging kit	1 lbs	<b>69.99</b>

**NEW CARBON FIBER OUTRIGGER POLES AND ACCESSORIES AVAILABLE AT WWW.DEFENDER.COM**

## Rod Holders



### SEA-DOG 3-ROD SIDE MOUNT

- Includes knife and plier holders
- Polypropylene
- No assembly required
- **Color:** Black or White

**Item** **650819** **Dimensions** 13-1/2" x 1-7/8" x 10-3/4" **Ship** 1 lbs **Net** **\$15.99**



### BOATMATES TRIPLE ROD HOLDER

- Stainless steel organizer has a place for your filet knife, pliers, baits and a convenient shelf for extra line or scents

**Item** **303688** **Model** **2221** **Dimensions** 13.5" L x 9.5" W x 3" D **Ship** 5 lbs **Net** **\$81.99**



### TACO STAINLESS CLAMP ON ROD HOLDER

- 316 stainless steel
- Rotates and locks every 18°
- Easy clamp-on installation

**Item** **350039** **Model** **F16-2600POL-1** **Dimensions** 7/8" and 1" O.D. tube **Ship** 3 lbs **Net** **\$75.99**  
**350040** **F16-2623POL-1** 1-1/16", 1-5/16" and 1-1/4" tube **4 lbs** **\$77.99**



### PERKO CLAMP ON ROD HOLDER

- Chrome plated zinc alloy and polished stainless steel tube with a hard Black plastic liner

**Item** **351115** **Model** **1215DPOCHR** **Dimensions** 9" Long, 1-5/8" I.D. 2" O.D. tube **Ship** 2 lbs **Net** **\$61.99**



### PERKO ANGLED FLUSH MOUNT FISH ROD HOLDER

- 65° polished stainless steel flange with Anodized aluminum tube
- Soft Black inner liner and flange gasket with flip-up cap
- Tube I.D.: 1-5/8"; Tube O.D.: 2"; Length under flange: 8-1/4"; Flange dimensions: 4-1/8" x 3-3/8"

**Item** **351116** **Model** **0452DPOSTS** **Ship** 2 lbs **Net** **\$66.99**



### SEA-DOG FLUSH MOUNT ECONOMY ROD HOLDER

- Formed 304 stainless steel
- Includes gasket and plastic cap and sleeve

**Item** **650828** **Model** **325171-1** **Length** 9-3/8" **Tube I.D.** 1-1/2" **Angle** 30° **Ship** 2 lbs **Net** **\$24.99**  
**650829** **325173-1** 8-1/4" 1-9/16" 90° 2 lbs **24.99**



### SEA-DOG 2-POLE SIDE MOUNT ROD HOLDER

- Holds (2) rods, knife and tools
- Injection molded polypropylene

**Item** **650970** **Color** Black or White **Dimensions** 9" x 1-3/4" x 10-3/4" **Ship** 1 lbs **Net** **\$12.99**



### TACO STANDARD OUTRIGGER RELEASE ZIP CLIP

- Stainless steel and plastic
- Perfect for light and medium duty

**Item** **651023** **Model** **COK-0001B** **Ship** 1 lbs **Net** **\$17.99**

### WHITE WATER TAPERED ADJUSTABLE ROD HOLDER

- Type: Clamp-on, Angle: 360° adjustment • Rail Size: 3/4" to 1-1/4", Material: 304 / 316 stainless steel • I.D. 1-5/8", O.D. 2-1/4"

**Item** **651046** **Model** **53300SL** **Ship** 1 lbs **Net** **\$59.99**

### TACO STAINLESS STEEL 3-ROD/REEL HOLDER

- Pre-drilled for easy mounting vertically or horizontally
- Stainless steel, Delrin and UV-stabilized polyethylene
- Rod tip holder with spring lock design locks rods in position

**Item** **755803** **Model** **F16-2753-1** **Ship** 4 lbs **Net** **\$128.99**

### SEATEAK FISHING ROD STORAGE RACK (PAIR)

- Requires 60609 mounting boards
- Hand sanded and hand finished 100% teak

<b>Item</b>	<b>Model</b>	<b>Size</b>	<b>Ship</b>	<b>Net</b>
<b>401180</b>	<b>60610</b>	2 Rods 2-7/8" H x 3/4" W x 8-1/2" L	1 lbs	<b>\$15.99</b>
<b>401181</b>	<b>60612</b>	4 Rods 2-7/8" H x 3/4" W x 15-1/2" L	2 lbs	<b>28.99</b>
<b>401184</b>	<b>60614</b>	6 Rods 2-7/8" H x 3/4" W x 22-1/2" L	2 lbs	<b>35.99</b>
<b>401182</b>	<b>60609</b>	Mounting boards 9/16" H x 1-5/8" W x 3-5/16" L	1 lbs	<b>8.99</b>

## Fishing/Cockpit Accessories

### TODD LIGHTWEIGHT T-TOP ELECTRONICS/RADIO BOX

- Stainless steel hardware
- Smoked plexiglass front panel
- Rubber gasket
- Chrome key lock
- Mounting hardware is not included

**Item** **252601** **Model** **18-1925** **Ship** 32 lbs **Net** **\$367.99**

**Dimensions:** Inside: 23-1/4" W x 9-3/4" H x 13" D  
 Outside: 24" W x 10" H x 14" D

**Item** **252602** **Model** **18-1924** **Ship** 42 lbs **Net** **408.99**

### KWIK TEK T-BAG, T-TOP/BIMINI TOP STORAGE PACK

- UV and water resistant 600-denier polyester pack cloth
- Holds Type II life jackets and other gear
- (2) Zippered compartments and (3) mesh pockets

**Item** **950051** **Model** **PFD-T4** **Holds PFDs/Size** (4) Type II PFDs/25" W x 20" D x 6" H **Ship** 4 lbs **Net** **\$49.99**  
**950050** **PFD-T6** (6) Type II PFDs/37" W x 20" D x 6" H **5 lbs** **56.99**

### STAINLESS LINE CUTTER/KNIFE & KNIFE SHARPENER

- Fixed blade with line cutter
- Blade type: Straight
- Top serrated for scaling
- Locking, vented sheath
- Stainless steel blade with plastic handle

<b>Item</b>	<b>Model</b>	<b>Description</b>	<b>Blade Length</b>	<b>Total Length</b>	<b>Ship</b>	<b>Net</b>
<b>756564</b>	<b>87201</b>	Bait knife	4"	9.25"	1 lbs	<b>\$7.99</b>
<b>756565</b>	<b>87101</b>	Filet knife	6"	11"	1 lbs	<b>9.99</b>
<b>756563</b>	<b>46811</b>	Sharpener, 2-1/4" x 1-1/2" x 1"			1 lbs	<b>4.99</b>

❖ For more detailed product specifications and our complete selection visit [www.defender.com](http://www.defender.com) or call 800-628-8225. ❖



Do-It-Yourself Repair Center



Most items ship 1 lbs unless noted.



ROUND BASE

316 stainless steel. Cast type.

Item	Model	No.	Description	Base	Fastener	Net
755983	S3650-0900	1	90°, 7/8"	2-5/8"	#10	\$15.99
755984	S3650-0600	2	60°, 7/8"	2-5/8"	#10	15.99
755985	S3650-0450	3	45°, 7/8"	2-5/8"	#10	15.99
755986	S3650-0300	4	30°, 7/8"	2-5/8"	#10	15.99
755987	S3650-0901	1	90°, 1"	2-13/16"	1/4"	16.99
755988	S3650-0601	2	60°, 1"	2-13/16"	1/4"	16.99
755989	S3650-0451	3	45°, 1"	2-13/16"	1/4"	16.99
755990	S3650-0301	4	30°, 1"	2-13/16"	1/4"	16.99

RECTANGULAR BASE

Item	Model	No.	Description	Base	Fastener	Net
755997	S3651-0900	1	90°, 7/8"	3-3/32" x 1-3/4"	#10	\$14.99
755995	S3651-0600	2	60°, 7/8"	3-3/32" x 1-3/4"	#10	14.99
755993	S3651-0450	3	45°, 7/8"	3-3/32" x 1-3/4"	#10	14.99
755991	S3651-0300	4	30°, 7/8"	2-2/5" x 1-3/4"	#10	14.99
755998	S3651-0901	1	90°, 1"	3-1/4" x 1-7/8"	1/4"	15.99
755996	S3651-0601	2	60°, 1"	3-1/4" x 1-7/8"	1/4"	15.99
755994	S3651-0451	3	45°, 1"	3-1/4" x 1-7/8"	1/4"	15.99
755992	S3651-0301	4	30°, 1"	3-1/4" x 1-7/8"	1/4"	15.99
755999	S3652-0900	-	90°, 7/8"	1-1/4" x 2-43/50"	1/4"	14.99
756000	S3652-0901	-	90°, 1"	1-21/50" x 3-1/5"	1/4"	15.99

\* 2 mounting holes

UNIVERSAL TEES

Item	Model	No.	Description	Net
756004	S3660-0900	1	90°, 7/8"	\$12.99
756002	S3660-0600	2	60°, 7/8"	13.99
756005	S3660-0901	1	90°, 1"	13.99
756003	S3660-0601	2	60°, 1"	14.99

BOW FORMS & ELBOWS

Item	Model	No.	Description	Net
756009	S3665-0900	1	Elbow, 90°, 7/8"	\$17.99
756011	S3666-0000	2	3-Way, 90°, 7/8"	16.99
756007	S3663-0000	3	Bow Form, 110°, 7/8"	18.99
756010	S3665-0901	1	Elbow, 90°, 1"	14.99
756012	S3666-0001	2	3-Way, 90°, 1"	15.99
756008	S3663-0001	3	Bow Form, 125°, 1"	21.99

END CAPS

Item	Model	No.	Description	Net
756025	S3679-0000	2	Flat, 7/8"	\$5.99
756062	S3608-0025	1	Bullet, 1"	8.99
756026	S3679-0001	2	Flat, 1"	5.99

DECK HINGES

Item	Model	Style	Base	Net
756048	S3682-0000	Side	.92" x 2"	\$6.99
756049	S3682-1000	Heavy side	2-13/16" x 1-17/20"	9.99
756053	S3682-4000	80°, Screwed	2-1/4" x 4/5"	7.99
756054	S3682-4001	80°, Drilled	2-1/4" x 4/5"	7.99
756050	S3682-2000	90°, Screwed	2-1/4" x 73/100"	8.99
756055	S3682-5000	90°, Removable pin	2-1/4" x 4/5"	10.99
756051	S3682-3000	Concave, drilled	2-1/4" 17/25"	6.99
756052	S3682-3001	Concave, removable	2-1/4" x 3/4"	8.99

SUNCOR STAINLESS STEEL BIMINI TOP PIN WITH RING

Item	Model	Pin dia.	Pin Grip L	Ring dia.	Net
756061	S3685-0001	1/4"	1"	1"	\$5.99

SUNCOR STAINLESS STEEL BIMINI TOP PIN WITH RING & LANYARD

Item	Model	Pin dia.	Pin Grip L	Lanyard L	Net
756060	S3685-0000	1/4"	1"	6"	\$5.99

SEA-DOG SURFACE MOUNT HAND RAIL

• Stainless steel with formed end (Fasteners not included).  
• Available lengths: 12-1/4", 18-1/4" or 24-1/4"  
Starting at \$21.99

WHITE WATER STAINLESS STEEL ROUND GRAB RAIL

• 1" tubing diameter • Flange mount  
• 2-1/2" flange diameter • #8 FH fasteners (Not Included)  
• Available lengths: 9-1/2", 15-1/2", 21-1/2", 33-1/2" or 45-1/2"  
Starting at \$38.99

WHITE WATER STAINLESS STEEL OVAL GRAB RAIL

All Ship 1 lbs  
• Tubing diameter: 1"-3/4" Oval • Material: 304 stainless steel, Height: 2-1/8"  
• Mount: End studs, Stud: 5/16"-18, Stud length: 1-7/8", Fasteners: 5/16"-18 Nut  
• Studs on center: 10-3/4", 16", 16-3/4", 22-3/4" or 34-3/4" Starting at \$21.99

TOP CAPS & SLIDES

Item	Model	No.	Description	Fasteners	Net
756027	S3680-0000	1	Top cap, 7/8"	N/A	\$8.99
756030	S3681-0000	2	Top slide, 7/8"	N/A	11.99
756056	S3683-0000	3	Hinged top slide, 7/8"	N/A	12.99
756058	S3684-0000	4	Multi-directional top cap, 7/8"	#10	22.99
756028	S3680-0001	1	Top cap, 1"	N/A	9.99
756029	S3680-1001	1	Heavy-duty top cap, 1"	N/A	10.99
756031	S3681-0001	2	Top slide, 1"	N/A	10.99
756032	S3681-1001	2	Heavy-duty top slide, 1"	N/A	11.99
756057	S3683-0001	3	Hinged top slide, 1"	N/A	14.99
756059	S3684-0001	4	Multi-directional top cap, 1"	#10	21.99

HAND RAIL FITTINGS

Item	Model	No.	Description	Net
756017	S3672-0600	1	Hand rail center, 60°, 7/8"	\$12.99
756013	S3670-1200	2	Hand rail end, 120°, Forward, 7/8"	12.99
756015	S3671-0600	3	Hand rail end, 60°, Aft, 7/8"	12.99
756020	S3673-1600	4	Rail stanchion center, 7/8"	12.99
756019	S3673-0600	5	Rail stanchion end, 7/8"	12.99
756018	S3672-0601	1	Hand rail center, 60°, 1"	13.99
756014	S3670-1201	2	Hand rail end, 120°, Forward, 1"	13.99
756016	S3671-0601	3	Hand rail end, 60°, Aft, 1"	13.99

HAND RAIL FITTINGS

Item	Model	No.	Description	Net
756023	S3676-0055	1	End mount out, 7°, 3/4"	#10 \$13.99
756024	S3677-0055	2	End mount in, 5°, 7/8"	#10 13.99
756021	S3675-0900	3	Under mount end, 7/8"	1/4" 28 UNF 22.99
756022	S3675-0901	3	Under mount end, 1"	1/4" 28 UNF 24.99

HAND RAIL FITTINGS

Item	Model	No.	Description	Fasteners	Net
756023	S3676-0055	1	End mount out, 7°, 3/4"	#10	\$13.99
756024	S3677-0055	2	End mount in, 5°, 7/8"	#10	13.99
756021	S3675-0900	3	Under mount end, 7/8"	1/4" 28 UNF	22.99
756022	S3675-0901	3	Under mount end, 1"	1/4" 28 UNF	24.99

TACO CLAMP-ON JAW SLIDE

• 1" Rail size • Material: Polished 316 stainless steel • Hinged  
• 1/4" bolt diameter

Item	Model	Ship	Net
100803	F12-1001-1	1 lbs	\$22.99

GEMINI PANEL MOUNTING KITS

Item	Model	Inside Diameter	Ship	Net
100872	GEMSJ-78	7/8"	1 lbs	\$22.99
100873	GEMSJ-1	1"	1 lbs	23.99
100875	GEMSJ-125	1-1/4"	1 lbs	27.99

Heavy Duty Stainless Steel Tubing

Type 304 marine grade TIG welded.  
1" OUTSIDE DIAMETER, .065" (1/16") THICK

Item	Model	Length	Ship	Net
756753	6025-2	24"	2 lbs	\$16.99
	6025-4	48"	3 lbs	29.99
	6025-6	* 72"	4 lbs	36.99
	6025-92	* 92"	5 lbs	46.99

WHITE WATER TUBE CONNECTOR

756744	6896S	1" O.D. x 3" L	1 lbs	16.99
756745	6895S	7/8" O.D. x 3" L	1 lbs	16.99

Stainless Steel Tubing

Type 304 Marine grade TIG welded. Heavy Duty

7/8" DIA. X .049" THICK				7/8" DIA. X .065" THICK				1" DIA. X .049" THICK			
Item	Len.	Ship	Net	Item	Len.	Ship	Net	Item	Len.	Ship	Net
756754	24"	1 lbs	\$10.99	756755	24"	2 lbs	\$12.99	756752	24"	1 lbs	\$11.99
	48"	2 lbs	21.99		48"	3 lbs	24.99		48"	2 lbs	26.99
	* 72"	3 lbs	28.99		* 72"	4 lbs	29.99		* 72"	3 lbs	34.99
	* 92"	4 lbs	34.99		* 92"	5 lbs	38.99		* 92"	4 lbs	40.99

# Hinges, Latches, Handles & Hardware



## SUNCOR HEAVY DUTY DOOR HINGE Ships 1 lbs

- Precision cast 316 stainless steel • Fasteners not included

Item	Model	Size	Fastener	Net/Pr.
012086	S3822-0075	3"	#10	\$18.99
012087	S3822-0100	4"	#10	22.99

## SUNCOR HEAVY DUTY TAKE APART HINGE Ships 1 lbs

- 316 stainless steel • Fasteners not included
- Locking tab to prevent hinge from coming apart

Item	Model	Size	Fastener	Net
012088	S3824-2000	3-1/2"	#10	\$14.99

## SUNCOR HEAVY DUTY FLUSH TABLE HINGE Ships 1 lbs

- 316 Stainless Steel • Fasteners not included
- Use for a completely flat surface

Item	Model	Size	Fastener	Net
012093	S3833-0001	3-1/4"	#10	\$15.99

## SUNCOR HEAVY DUTY HATCH HINGE Ships 1 lbs

- Precision cast • Fasteners not included
- Pin is 316 stainless steel and removable

Item	Model	Size	Fastener	Net
012094	S3824-0075	3"	#10	\$24.99

## SUNCOR HEAVY DUTY STRAP HINGE Ships 1 lbs

- 316 stainless steel • Precision cast components
- Welded pin prevents loosening • Fasteners not included

Item	Model	Size	Fastener	Net
012084	S3820-0100	4"	#10	\$10.99
012085	S3820-0150	6-3/8"	#10	15.99

## SUNCOR FLUSH STRAP HINGE Ship 1 lbs

- 316 stainless steel • Fasteners not included
- Use where recessed hinges are needed.

Item	Model	Size	Fastener	Net
012089	S3831-0001	4"	#10	\$15.99

## SUNCOR FLUSH DOOR HINGE Ships 1 lbs

- 316 stainless steel • Fasteners not included
- Exclusive flush design allows for maximum movement

Item	Model	Size	Fastener	Net
012091	S3830-0001	3"	#8	\$16.99
012092	S3830-0002	4"	#8	20.99

## WHITECAP T-STRAP HINGE Ships 1 lbs

- 316 stainless steel • Fasteners not included

Item	Model	Size	Fastener	Net
753338	6384	7-3/4" x 3-7/8"	#12	\$35.99

## STAINLESS STEEL CONTINUOUS HINGE Ships 1 lbs

For use on hatch covers, locker doors, windshields, etc. Holes are two inches apart center to center, .042 gauge steel. Polished to mirror finish. Fasteners not included.

Item	Model	Length	Open Width	Fastener	Net
752350	3-0534-0027	72"	1-1/4"	#5	\$27.99
752351	3-0535-0029	72"	1-1/2"	#6	28.99
752352	3-0536-0013	72"	2"	#6	31.99

## Stainless Steel Flat Hatch Trim Ships 3 lbs

- Fasteners not included.

Item	Model	Size	Fastener	Net
752358	2900-06	1-1/4" x 6'	#6	\$29.99
752359	3000-06	1-1/2" x 6'	#6	29.99

## SUNCOR HEAVY DUTY BARREL BOLT Ships 1 lbs

- Precision cast stainless steel • Fasteners not included

Item	Model	Size	Fastener	Net
012082	S3855-0001	3-5/8"	#8	\$15.99
012083	S3855-0002	4-1/4"	#8	15.99

## SEA-DOG CUPBOARD BOLT Ships 1 lbs

- Chromed brass • Fasteners not included

Item	Model	Size L" x W"	Fastener	Net
752441	222380-1	1-1/2 x 2-1/4	#6	\$13.99

## SUNCOR HEAVY DUTY DOOR HOOK SET- Ship 1 lbs

- 316 stainless steel • Fasteners not included

Item	Model	Size	Fastener	Net
012080	S3850-0001	3"	#6	\$18.99
012081	S3850-0002	4"	#6	19.99

## PERKO MORTISE LATCH SET Ships 2 lbs

- Chrome plated zinc alloy • Turn button lock

Item	Model	Size	Fastener	Net
990025	0960DP0CHR	2-1/4" x 1-13/16"	#8	\$85.99

## SEA-DOG ANTI-RATTLE LATCH Ships 1 lbs

- Investment cast 316 stainless • Fasteners not included
- Designed for cabinets and hatches

Item	Model	Size	Fastener	Net
401270	221100-1	3" x 1-1/2"	#10	\$15.99

## SEA-DOG ANTI-RATTLE LATCH Ships 1 lbs

- Chrome plated, sand cast brass • Fasteners not included

Item	Model	Size	Fastener	Net
401013	222110-1	4" x 2"	#10	\$12.49

## SUNCOR HEAVY DUTY SAFETY HASP Ships 1 lbs

- Cast 316 stainless steel. Secure hasp without use of lock. Fasteners not included.

Item	Model	Size	Fastener	Net
012079	S3853-0002	3"	#8	\$16.99

## SEA-DOG PUSH BUTTON RIM LATCH Ships 1 lbs

- Polished chrome knob. Plastic body. Max. door thickness 1". Fasteners not included.

Item	Model	Fastener	Net
751050	224300-1	#6	\$15.99

## SEA-DOG DOOR BUTTON Ships 1 lbs

- Chrome plated. 1-3/4" Dia. Fasteners not included.

Item	Model	Fastener	Net
754720	222360-1	#6	\$7.99

## PERKO FLUSH RING CATCH Ships 1 lbs

- Chrome plated die cast zinc alloy. Bronze spring. Fasteners not included.

Item	Model	Size	Fastener	Net
754315	1051DP0CHR	2-1/4" x 1-3/8"	#6	\$25.99

## WHITECAP FLUSH LIFT RING & LIFT HANDLE Ships 1 lbs

- Chrome plated brass. For opening hatch lids and on decks and other surfaces where no protuberance is desired. Fasteners not included.

Item	Model	Size	Fastener	Net
752426	S-3362 ring	2" x 2-1/2"	#6	\$9.99
755044	S-3360 ring	1-1/2" x 1-3/4"	#6	10.99
752423	S-3364 handle	3" x 2"	#8	11.99

## SUNCOR HEAVY DUTY FLUSH LIFT RING Ships 1 lbs

- Heavy duty lift ring with precision cast stainless steel components. Fasteners not included.

Item	Model	Size	Fastener	Net
012095	S3851-0000	2-1/2"	#8	\$13.99
012096	S3851-0001	1-7/8"	#8	13.99

## WHITE WATER ROUND RING PULL

- Diameter: 2" • Depth: 1/2"
- Material: 316 stainless steel

Item	Model	Fastener	Ship	Net
651043	6092S	#8	2 lbs	\$12.99

## OSCUATI ECLIPSE CAM LATCH WITH LOCK Ships 2 lbs

- Includes 2 keys
- 316 grade stainless steel

Item	Cutout	Diameter	Thickness	Adjustable Stop Lever	Net
608920	50mm	60mm	12.8-23mm	25.2-76.2mm	\$54.99
	60mm	75mm	24.5-35mm	31.3-82.3mm	69.99

## WHITECAP SLAM LATCH Ships 1 lbs

- 316 stainless steel flush slam latch. Fasteners provided. Max mat thickness: 5/8". Cutout: 1-7/8". Depth: 15/16".

Item	Model	Flange Size	Net
600970	S-0227	Non-locking 2-3/8"	\$29.99

## WHITECAP T- HANDLE

- Diameter - 3", Cutout - 2-1/2", Surface depth - 1/8" - 3/4", Shaft length - 1-3/8". For use with hatches with a long lip.

Item	Description	Ship	Net
600964	Chromed zinc, locking	1 lbs	\$31.99
600965	Chromed zinc, non-locking	1 lbs	22.99
600969	Stainless steel, locking	2 lbs	68.99
600968	Stainless steel, non-locking	1 lbs	65.99

## SEA-DOG STAINLESS STEEL HATCH PULL

- Stamped 304 stainless steel pull and rubber gasket.

Item	Model	Ship	Net
755973	221842-1	1 lbs	\$5.49

## PERKO ELBOW CATCHES-PAIR Ships 1 lbs

- Black plastic, integral spring, #6 size screws (Sold separately).

Item	Model	Size	Net
754313	1021DP0BLK	1-3/16" x 5/8"	\$5.99

## SEA-DOG ELBOW CATCHES PAIR Ships 1 lbs

- Chromed brass. Sold as 2 sets (latch and catch in a set). Fasteners not included.

Item	Model	Size	Fastener	Net
753271	222330-1	1-1/8" x 1-5/16"	#6	\$6.99

## SOUTHCO SIDE MOUNT GRABBER CATCH LATCH Ships 1 lbs

- Type: concealed push-to-close / pull-to-open
- Spring color: Black, Material: plastic, Color: Black

Item	Model	Size	Net
606955	C3-810	2-4/5" x 1-4/5"	\$9.99

## SOUTHCO FRONT MOUNT SOFT DRAWER LATCH Ships 1 lbs

- Material: rubber and stainless steel, Color: Black
- Low-profile design conceals mechanisms and hardware

606956	C7-10	Black	4-4/25" stretched	\$17.99
606957	C7-10-02	White	4-4/25" stretched	17.99





## Latches, Hardware & Bolts

### SCHAEFER TRANSOM DOOR LATCH HANDLE AND CATCH PLATE

- 316 polished stainless steel
  - Allows one handed operation of transom doors
  - Base dimensions: 4-1/2" L x 3-1/2" W x 2-3/4" H
  - 4 x 1/4" flat head fasteners required (not included)
- Item **604448** Model **TDH-900** Ship 3 lbs **Net \$188.99**



### PLASTIC DOOR LATCH

- Screws not included
  - 1-1/2" x 1/2" x 1/2"
- Item **752443** Model **I540** Ship 1 lbs **Net \$1.99**

### EYE STRAPS - Fasteners not included. Ships 1 lbs.

Stainless steel eye strap      Black nylon eye strap

Item	Model	Material	Ctr./Ctr.	Eye	Fastener	Net
752286	S-295	304 Stainless steel	1-5/8"	3/8"	3/16"	\$3.49/pair
601285	RF94A	316 Stainless steel	1-1/8"	3/16"	3/16"	3.95 each
615141	RF1055	316 Stainless steel	1-11/16"	5/8"	1/4"	4.29 each
605733	2133	304 Stainless steel	1-13/16"	9/16"	#10	6.99 each
605734	2134	304 Stainless steel	1-3/4"	5/8"	1/4"	7.99 each
752287	3407-B	Black nylon	1-3/8"	3/8"	#10	3.99 4-pk

### SUNCOR BULLSEYE FAIRLEAD - 316 stainless steel. Ships 1 lbs.

Item	Model	Max Line	Fastener	Net
608965	S3730-0010	5/16"	#8	\$8.99
	S3730-0014	1/2"	#10	9.99
	S3730-0016	5/8"	#12	12.99

### SEA-DOG MACHINED 304 STAINLESS STEEL "U" BOLT

Millions of uses. All ship 1 lbs.

Item	Model	Metric Thread	Length	Centers	Breaking Strength	Net
000438	080253-1	3/16" (5 mm)	2-5/8"	1-3/16"	1950	\$9.99
000439	080265-1	1/4" (6 mm)	3-3/16"	1-5/16"	2950	10.99
000440	080288-1	5/16" (8 mm)	4-1/2"	1-5/16"	3850	13.99

### WHITECAP 316 STAINLESS STEEL DOOR HOLDER WITH CUSHION

- Base diameter: 1-7/8"
  - Standoff length: 2-7/16"
- Item **600972** Model **S-0040** Fastener (not included) #10 (5) Ship 1 lbs **Net \$21.99**



**WICHARD WATERTIGHT U-BOLTS** Watertight rubber collar means no noise, no leaking and no vibration. Assures a tight fit eliminating the need for messy silicon sealers in most applications. Wichard U-bolts are built to metric dimensions. **Imperial conversions are approximate.** All ship 1 lbs.

Black		White		Approx. Dia.	Metric Thread	L mm	A mm	B mm	C mm	SWL lbs	Net
607623	65331	607624	65332	1/4"	m6	70 (2-3/4")	32 (1-17/64")	24 (15/16")	35 (1-3/8")	2822	\$21.99
607625	65431	607626	65432	1/4"	m6	90 (3-35/64")	32 (1-17/64")	24 (15/16")	55 (2-11/64")	2822	23.99
607628	65341	607629	65342	5/16"	m8	80 (3-5/32")	36 (1-27/64")	25 (63/64")	40 (1-9/16")	5291	26.99
607630	65441	607631	65442	5/16"	m8	100 (3-15/16")	36 (1-27/64")	25 (63/64")	60 (2-23/64")	5291	29.99
607632	65351	607633	65352	13/32"	m10	90 (3-35/64")	40 (1-9/16")	26 (1-1/32")	45 (1-49/64")	7937	41.99
607634	65451	607635	65452	13/32"	m10	110 (4-21/64")	40 (1-9/16")	26 (1-1/32")	65 (2-9/16")	7937	50.99
607636	65361	607637	65362	15/32"	m12	110 (4-21/64")	44 (1-47/64")	27 (1-11/16")	50 (1-31/32")	14110	72.99
607638	65461	607639	65462	15/32"	m12	130 (5-1/8")	44 (1-47/64")	27 (1-11/16")	70 (2-3/4")	14110	79.99

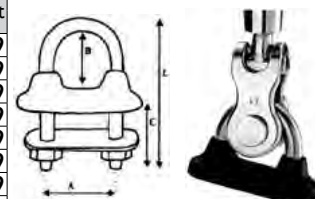

### SUNCOR BOW/STERN EYE

304 stainless steel formed. Each bolt set includes four nuts (two standard and two beveled), one bow plate and one stern plate. Threads are UNC. All ship 1 lbs.

Item	Model	A	B	C	D	UNC	SVL lbs	Net
552097	S0353-10055	3/8"	1.03"	1.13"	2.25"	3/8-16	3200	\$13.99
552098	S0353-10090	3/8"	1.03"	3.00"	4.00"	3/8-16	3200	16.99
552099	S0353-10115	3/8"	1.03"	4.00"	5.00"	3/8-16	3200	16.99
552100	S0353-11120	7/16"	1.50"	3.44"	5.00"	7/16-14	3800	24.99
552101	S0353-11150	7/16"	1.50"	4.50"	6.00"	7/16-14	3800	25.99
552102	S0353-13095	1/2"	1.31"	2.50"	3.87"	1/2-13	4800	23.99
552103	S0353-13120	1/2"	1.31"	3.44"	4.85"	1/2-13	4800	25.99
552104	S0353-13150	1/2"	1.31"	4.75"	6.00"	1/2-13	4800	27.99
552105	S0353-13180	1/2"	1.31"	6.00"	7.25"	1/2-13	4800	29.99



### WHITECAP STAINLESS STEEL GAS SPRINGS- All ship 1 lbs.

- Gas lift springs with bodies constructed of 316 stainless steel
- O-ring ensures proper sealing to force oil towards the orifice piston
- Hydraulic fluid, specially formulated to provide end of travel damping
- Piston assembly provides precise control during the extension stroke

Please specify force

Item	Compressed Length	Extended Length	Force (lbs)	Net
755561	7"	10"	20 or 40	\$31.99
755562	9.5"	15"	40 or 60	33.99
755563	10.25"	17"	20, 40, 60 or 90	34.99
755564	12"	20"	40, 60 or 90	35.99



### ACCESSORIES- All ship 1 lbs.

Item	Model	Description	Net
755565	G-1020SS	304 SS mounting brackets (pair) 2-1/4" x 3/4" x 1-7/16"	\$18.99
755566	G-1060SS	304 SS mounting brackets (pair) 2" x 1-1/4" x 1"	19.99
755567	G-1005SS	304 SS ball stud, 1-3/16"	8.99
755568	G-1030	Black plastic end fitting, 10 mm	7.99



## Locks

### SESAMEE KEYLESS PADLOCK All ship 1 lbs.

- Solid brass, heavy pressure cast body
- Rust resistant double locking mechanism
- 10,000 combinations - Combination easily set and reset
- 1" shackle; 1-11/16" L x 1-7/8" W
- Full instructions furnished

Item	Model	Material	Net
752291	KO436	Solid brass body and shackle	\$26.29
752292	KCRO436	Chrome plated brass body and shackle	27.49
752293	K436	Solid brass body and chrome plated hardened steel shackle	24.99



### SESAMEE BRASS PADLOCKS All ship 1 lbs.

- 10,000 combinations
- Combination easily set and reset
- 2-1/4" shackle, special marine model
- Chrome plated finish

Item	Model	Net
752294	KO437	\$26.99



### SCANDVIK STAINLESS STEEL DOOR HOLDER All ship 1 lbs.

Keep doors or hatches at bay while under way. Easy installation.

Item	Model	Size	Length (Wall To Door)	Net
400736	10008	Small	1-1/2"	\$17.99
400737	10009	Large	1-5/8"	21.99
400738	14303	Large extended reach	2-3/4"	32.99

### SOUTHCO ONE-PIECE FLEXIBLE T-HANDLE DRAW LATCH

- Tight latch grip absorbs and reduces vibration
  - Rubber and stainless steel
  - Flexible stretch-and-latch
  - Finish: Matte Black
  - Mount: Front
- Item **606950** Model **37-20-101-20** Ship 1 lbs **Net \$29.99**



### SOUTHCO PUSH TO CLOSE LATCH

- Material: plastic
  - Color: Black
  - Panel thickness: Up to 10.300 mm (Up to 0.41")
  - Pull tab in-line with latching pawl
- Item **606952** Model **93-303** Locking Ship 1 lbs **Net \$21.99**  
 Item **606953** Model **93-304** Non-locking 1 lbs **18.99**

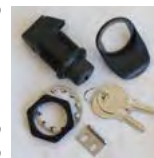

### WHITE WATER CABINET CATCH

- Type: Ball catch
  - Dimensions: 2-1/4" L x 7/16" W x 1/2" H
  - Requires 4 #8 flat head screws (not included)
- Item **402779** Model **2100B** Polished brass Ship 1 lbs **Net \$8.99**  
 Model **2100BC** Chrome 1 lbs **7.99**



### WHITECAP HEAVY DUTY MAGNETIC DOOR CATCH

- Style: Swiveling (180 degrees)
  - Includes very strong rare earth magnets
  - Holds a door open in rough conditions
  - Dimensions: Main Base: 3/4" x 1-7/16"
  - Catch base: 1-1/16" x 1-13/16"
- Item **756927** Model **S-1407** Finish Chrome plated zinc Ship 1 lbs **Net \$29.99**  
 Model **S-1407B** Black powder coated zinc 1 lbs **29.99**  
 Model **6037** Solid 316 stainless steel 1 lbs **54.99**



**Snaps, Hooks, Rings and Quick Links**



**A. BRONZE FAST EYE SNAP**

Item	Model	Length	Eye	Hook	Ship	Net
756856	S-1121	2-7/8"	5/8"	5/16"	1 lbs	\$5.99
	S-1122	3-1/4"	1 1/16"	7/16"	1 lbs	7.99
	S-1123	3-7/8"	3/4"	1/2"	1 lbs	12.99

**B. BRONZE SWIVEL EYES**

Item	Model	Length	Eye	Hook	Ship	Net
756858	S-1105	3-3/4"	3/4"	7/8"	1 lbs	10.99
	S-1106	4-9/16"	7/8"	1"	1 lbs	10.99

**C. BRONZE SWIVEL TRIGGER SNAP**

Item	Model	Length	Eye	Hook	Ship	Net
752486	S-1100	2-5/8"	1/2"	7/16"	1 lbs	\$9.99

**D. FAST EYE BABY SNAP**

Item	Model	Finish	Length	Opening	Ship	Net/Pair
756857	138420-1	Bronze	1-13/16"	7/16"	1 lbs	\$4.99
	138425-1	Chrome	1-13/16"	7/16"	1 lbs	3.69

**E. 1/4" BRONZE RING**

Item	Model	Wall Thickness	I.D.	Ship	Net
752457	192050	1/4"	2"	1 lbs	\$3.00

**F. GALVANIZED RINGS**

Item	Model	Length	Eye	Ship	Net
003368	192520	5/16"	2"	1 lbs	\$1.29
	192525	5/16"	2-1/2"	1 lbs	1.59
	192625	3/8"	2-1/2"	1 lbs	1.79
	192830	1/2"	3"	1 lbs	4.49

**G. WICHARD STAINLESS STEEL EYE BOLT**

Item	Model	Length	Eye	Ship	Net
608889	6493	100 mm	14 mm	1 lbs	\$31.99
	6492	80 mm	14 mm	1 lbs	31.99
	6491	60 mm	12 mm	1 lbs	23.99



**H. WICHARD STAINLESS STEEL SNAP HOOKS**

Item	Model	Length	WL	Ship	Net
608885	2480	50 mm	200 kg	1 lbs	\$22.99
	2481	75 mm	480 kg	1 lbs	31.99
	2482	100 mm	1120 kg	1 lbs	56.99

**I. WICHARD STAINLESS STEEL STANDARD SYMMETRIC CARBINE HOOKS**

Item	Model	Length	WL	Ship	Net
608886	2313	60 mm	360 kg	1 lbs	\$23.99
	2315	80 mm	880 kg	1 lbs	27.99
	2316	100 mm	1200 kg	1 lbs	34.99
	2317	120 mm	1360 kg	1 lbs	56.99

**J. WICHARD STAINLESS STEEL ASYMMETRIC CARBINE HOOKS**

Item	Model	Length	WL	Ship	Net
608887	2323	60 mm	400 kg	1 lbs	\$24.99
	2325	80 mm	960 kg	1 lbs	29.99
	2326	100 mm	1320 kg	1 lbs	36.99
	2327	120 mm	1440 kg	1 lbs	62.99
	2328	170 mm	1440 kg	1 lbs	73.99

**K. WICHARD STAINLESS STEEL EYELESS CARBINE HOOKS**

Item	Model	Length	WL	Ship	Net
608888	2333	60 mm	360 kg	1 lbs	\$21.99
	2335	80 mm	880 kg	1 lbs	26.99
	2336	100 mm	1200 kg	1 lbs	31.99
	2337	120 mm	1360 kg	1 lbs	51.99

**L. SUNCOR HARNESS CLIP**

Item	Model	Stock Dia.	Length	WL	Ship	Net
756861	S0172-0060	1/4"	2-3/8"	260 lbs	1 lbs	\$6.99
	S0172-0080	5/16"	3-1/4"	750 lbs	1 lbs	10.99
	S0172-0100	3/8"	4"	1,200 lbs	1 lbs	17.99
	S0172-0120	1/2"	5"	2,000 lbs	1 lbs	26.99

**M. STAINLESS STEEL QUICK LINKS** Formed 316 stainless steel. All ship 1lbs.

Item	Stock Dia.	Length	Breaking Strength	Net
756860	1/8"	1-7/16"	2,420 lbs	\$5.99
	3/16"	1-15/16"	4,950 lbs	8.99
	1/4"	2-1/4"	7,150 lbs	11.99
	5/16"	2-7/8"	12,000 lbs	19.99
	3/8"	3-1/2"	19,800 lbs	24.99
	1/2"	4-1/8"	27,500 lbs	39.99

**N. GALVANIZED QUICK LINKS** Formed steel electro-galvanized. All ship 1lbs.

Item	Stock Dia.	Length	Breaking Strength	Net
003369	* 1/8"	1-7/16"	1,100 lbs	\$1.99/pr.
	3/16"	2"	3,080 lbs	1.69 each
	1/4"	2-1/4"	4,400 lbs	1.89 each
	5/16"	2-15/16"	7,700 lbs	1.99 each
	3/8"	3-1/2"	12,100 lbs	2.79 each
	1/2"	4-3/16"	18,000 lbs	4.29 each

\* This size only sold as a pair

**O. STAINLESS STEEL SECURITY SNAPS**

Item	Model	Length	Stock Dia.	Eye	Hook	Ship	Net
756859	S-1110	2-3/8"	1/4"	3/8"	3/8"	1 lbs	\$8.99
	S-1111	3-1/8"	5/16"	7/16"	7/16"	1 lbs	12.99

**Numbers, Letters, Placards and Labels**



**LETTER - NUMBER KIT** (148 pieces)

Pressure sensitive with peel off backing. (4) of each letter and number.

Item	Description	Ship	Net
756852	Black 3" tall	1 lbs	\$9.99
	White 3" tall	1 lbs	9.99

**BERNARD PLASTIC LETTERS & NUMBERS**

• Specify individual letter or number • Self adhesive • Color: Black

Item	Description	Ship	Net
750892	Individual letter or number	1 lbs	\$0.49



Racing Flag Signal

**FORESPAR WATERPROOF VINYL NASH MARINE LABELS**

Eliminate crew errors. Will not fade. Adheres permanently to metal, plastic or fiberglass. 1/4" Navy Blue letters or 3/8" numbers on White background. All ship 1 lbs.

Item	Model	Description	Net
601002	100010	Track nos. (1 - 14)	\$7.99
601003	100011	Scale (0" - 10")	6.99
601006	100014	Cleat and winch labels	7.99
601007	100015	Tank labels	\$7.99
601008	100016	Control lines	7.99
601009	100017	Racing flag signals	10.99
614534	100023	Instrument labels	7.99

**DISPOSAL OF GARBAGE REGULATIONS PLACARD**

Explains the federal vessels regulation regarding the discharge of garbage. Vinyl adhesive back, easy to apply. Actual dimensions 9-1/4" x 5-1/4" as required by law.

Item	Model	Ship	Net
500115	P-227	1 lbs	\$7.99



**BERNARD INDENTI-LABELS SAILBOAT LABEL SET**

• For safety and convenience, pressure-sensitive labels mark all important lines, controls and compartments on sailboats • Make sure your craft is ship-shape and safety ready • Will stick to any clean, smooth surface • (16) Labels per sheet • White letters on Black vinyl

Item	Model	Dimensions	Ship	Net
650929	IL-01	1/2" H x 2-1/4" L	1 lbs	\$5.99

**DISCHARGE OF OIL REGULATIONS PLACARD**

Required for vessels greater than 26' to be fixed in a conspicuous place in the machinery spaces or at the bilge and ballast pump control station. Self-stick adhesive back.

Item	Model	Dimensions	Ship	Net
951372	P-204	5" x 8"	1 lbs	\$7.99

**POSSESSION OF DRUGS REGULATIONS PLACARD**

Alerts all to 'Zero Tolerance' for possession of illegal drugs carried on board in any quantity and will report same to the U.S. Coast Guard and U.S. Customs. Vinyl adhesive back; easy to apply.

Item	Model	Dimensions	Ship	Net
750930	P-229	7-1/2" x 4"	1 lbs	\$8.99

**BERNARD MARINE REGULATION PLACARD - DISCHARGE OF GARBAGE FROM VESSEL**

• Rules for Discharge of Garbage from Vessels, Meets federal standards • Black letters engraved on molded White plastic plaque • Mount: Adhesive strips / screws

Item	Model	Dimensions	Ship	Net
650927	IL-227	9-1/4" x 4-1/2"	1 lbs	\$6.99

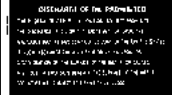



## Sealants, Caulks, Adhesives

### 3M™ Adhesives & Sealants

#### 3M MARINE ADHESIVE SEALANT 5200

- Very strong; Bonds to wood, fiberglass and metal
- Not for use where teak cleaners are used, such as decks
- Use above or below the waterline • Tack-free in 24-48 hours
- No priming necessary • Cures in 5-7 days
- Stays flexible and allows for structural movement



Item	Color	Description	Ship	Net
751257	White	1 oz.	1 lbs	\$9.99
754006	White or Black	3 oz.	1 lbs	13.99
754007	White or Black	10 oz.	1 lbs	17.99

#### 3M MARINE ADHESIVE SEALANT FAST CURE 5200

- Fast-cure version of 3M Marine Sealant 5200 • Tack-free in one hour
- Cures in 24 hours

Item	Model	Color	Description	Ship	Net
751263	06520	White	10 oz. cartridge	1 lbs	\$22.99
755232	05220	White	3 oz. tube	1 lbs	14.99
755612	06535	White	1 oz. tube	1 lbs	10.49

#### 3M MARINE ADHESIVE SEALANT FAST CURE 4200

- 1-part all-purpose polyurethane • 1/2 strength of 5200
- Watertight, weather resistant • Seals joints and boat hardware
- Paintable and sandable • Use above or below waterline
- Cures in 24 hours

Item	Color	Description	Ship	Net
754047	White or Black	10 oz.	1 lbs	\$18.99
755233	White	3 oz.	1 lbs	12.99

#### 3M MARINE ADHESIVE SEALANT FAST CURE 4000 UV

- Tack free in 20 minutes — cures in 24 hours • 1/2 strength of 5200 and removable
- Forms firm, rubbery, water-tight, paintable seal • Superior UV resistance
- Seals joints on wood, fiberglass, metal and most plastics • Use above or below the waterline
- Resistant to weathering, saltwater and stresses caused by joint movement

Item	Model	Color	Size	Ship	Net
Ⓞ 754962	05280	White	3 oz. tube	1 lbs	\$12.99
Ⓞ 754961	06580	White	10 oz. cartridge	1 lbs	16.99
755611	05503	Black	10 oz. cartridge	1 lbs	17.99

#### 3M MARINE ADHESIVE SEALANT 3000 UV

- Waterproof seal resistant to UV exposure • Single component elastomeric
- For use above/below the waterline • 50 minute skin time

Item	Color	Size	Ship	Net
756699	Black or White	290 ml	2 lbs	\$13.99

#### 3M MARINE GRADE SILICONE SEALANT

- Non-sagging, mildew resistant, moisture-curing silicone rubber • For use above waterline
- Excellent resistance to the marine environment • Remains flexible
- Adheres to bare and painted metals, fiberglass, glass, non-oily woods and many plastics
- Excellent as gasket adhesive or formed-in-place gasket material

Item	Color	Size	Ship	Net
754059	White or Clear	3 oz. tube	1 lbs	\$10.49
754060	White or Clear	10.3 oz. Cartridge	1 lbs	23.99

### Sikaflex® Adhesive Sealants

#### Sikaflex-291 Adhesive/Sealant 300 ml

Item	Color	Description	Net
755733	Black or White	General all-purpose marine sealant; single component; fast cure	\$14.99

#### Sikaflex-291 LOT Adhesive/Sealant 300 ml

755734	Black, White, Mahogany	General all-purpose marine sealant; single component; slow cure	\$14.99
--------	------------------------	-----------------------------------------------------------------	---------

#### Sikaflex 295 UV Adhesive/Sealant 300 ml

755736	Black or White	High UV resistance; fast curing; bonds glass, ceramics, metals, fiberglass and plastics	\$21.99
--------	----------------	-----------------------------------------------------------------------------------------	---------



### Adhesive and Sealant Removers

#### BOATLIFE RELEASE™ ADHESIVE AND SEALANT REMOVER

- Ideal for removing cured silicone, polyurethane and polysulfide
- Removes tapes, labels and decals from metal, fiberglass and wood

Item	Model	Size	Ship	Net
Ⓞ 755185	1291	1 oz. spray	1 lbs	\$10.99
Ⓞ 755186	1288	16 oz. spray	1 lbs	34.99



#### 3M ADHESIVE REMOVER

- Citrus-based cleaning agent removes adhesive residue, oils, grease and silicone
- Removes partially dried and some cured adhesives • Environmentally friendly

Item	Model	Size	Ship	Net
Ⓞ 751016	49048	18.5 oz	2 lbs	\$28.99



### Boatlife® Adhesives & Sealants

#### BOATLIFE LIFESEAL®

- Marine silicone and polyurethane formulated for fiberglass
- Skins in 10 min.; cures in 24 hrs • Use above or below waterline
- Low odor, high adhesion • Non-sagging, non-corrosive
- Non-yellowing formula • Mildew resistant

Please specify color: Clear, White or Black

Item	Size	Ship	Net	Item	Size	Ship	Net
753982	80 ml	1 lbs	\$10.49	753984	310 ml	1 lbs	\$16.99



#### BOATLIFE MARINE SILICONE RUBBER

- All-purpose 100% silicone marine sealant
- Use above or below waterline • Non-corrosive, non-yellowing
- Will not shrink, crack or dry out • Mildew resistant
- Superior adhesion to fiberglass, plastic, metal and wood

Please specify color: Clear, White or Black

Item	Size	Ship	Net	Item	Size	Ship	Net
753986	80 ml	1 lbs	\$7.99	753990	310 ml	1 lbs	\$13.99



#### BOATLIFE LIFE-CALK®

- For teak decks: to bed deck and hull hardware, seal thru-hull fittings and underwater seams
- Long-lasting, permanently flexible
- Marine polysulfide sealant
- Tack-free in 1 to 3 days
- Can be sanded and painted
- Use above or below the waterline
- Bonds to fiberglass, wood, metal, glass and itself
- Excellent resistance to teak oils, gasoline and diesel fuel

Please specify color: White, Black, Teak or Mahogany

Item	Size	Ship	Net
Ⓞ 753995	80 ml	1 lbs	\$10.99
Ⓞ 753996	310 ml	2 lbs	18.99

#### PRIMER For use on oily woods and metal

Ⓞ 751163	236 ml	1 lbs	16.99
----------	--------	-------	-------



#### BOATLIFE LIQUID LIFE-CALK

- Self-leveling formula for sealing fine cracks and seams
- UV resistant
- 24-hour cure

Item	Size	Color	Ship	Net
Ⓞ 753992	80 ml	White or Black	1 lbs	\$9.99



#### BOATLIFE TEAK DECK SANDABLE SILICONE SEALANT

- Marine silicone and polyurethane
- No priming necessary
- 24-hour curing system
- Tack-free in 30 minutes
- Sandable; especially designed for teak deck seams
- Resistant to teak cleaners, teak oils, gasoline and diesel fuel

Item	Size	Color	Ship	Net
753854	310 ml	Black	1 lbs	\$16.99



#### SUDBURY LIQUID ELASTOMERIC PENETRATING SEALANT

- Specially formulated to flow into narrow joints
- Ideal for sealing windshields, portholes, hatches, vents and seams
- Adheres without primer to fiberglass, plastic, glass, metal and wood

Item	Size	Color	Ship	Net
Ⓞ 755686	3 oz. tube	Clear	1 lbs	\$6.99

#### SUDBURY® ELASTOMERIC MARINE SEALANT

- Seals ports, beds hardware; stops leaks
- Heavy duty use above or below the waterline
- Fast skinning (10 minutes) • Fast curing (24 hours)
- Not recommended for wooden deck seams or areas subject to gasoline

Item	Size	Color	Ship	Net
Ⓞ 755680	3 oz. tube	Clear or White	1 lbs	\$6.99
Ⓞ 755681	10 oz. cartridge	Black, Clear or White	1 lbs	11.99



#### CAPTAIN TOLLEY'S CREEPING CRACK CURE PENETRATING SEALANT

- Finds and fixes leaks
- Seals hairline cracks
- Material: 2-Methylisothiazol-3-one, 1,2-Benzisothiazol-3-one and Bronopol
- Container: 2 ounces
- Cure time: 24 hours

Item	Color	Ship	Net
751386	Clear	1 lbs	\$9.99



Ⓞ Ships Ground Only - No Extra Charge 🚚 Ships by Truck

Ⓜ Larger Size Product, Ships at Dimensional Weight

⚠ Hazardous Material. \$35.00 Fee & Ships Ground Only

## MAS Epoxies & Hardeners



**FREE**  
HOW-TO VIDEO AT WWW.  
MASEPOXIES.COM



### Complete "Non-Blushing" Epoxy System

Time Saving Epoxy Resin System offers two resins and three hardener options. Great for clear coating, laminating and structural work. Use one system for construction, repairs and bright work. No messy wash downs between coats.

**LOW VISCOCITY RESIN** The reduced viscosity of MAS LV resin provides for complete wet out of fiber reinforced fabrics and reduces the potential for voids and other imperfections.

Item	Model	Description	Ship	M.A.P.
Ⓞ 751058	30-001	MAS resin (quart)	3 lbs	\$39.51
Ⓞ 751061	30-005	MAS resin (1/2 gallon)	5 lbs	71.75
Ⓞ 751063	30-002	MAS resin (gallon)	9 lbs	117.51
Ⓞ 755065	30-004	MAS resin (5 gallon)	51 lbs	579.27

**FLAG RESIN** FLAG resin is a medium body resin designed to perform as an adhesive and structural laminating foundation. Recommended for gluing, laminating, structural repairs, barrier coatings and cold molding. FLAG resin is more reactive and minimizes slumping on vertical surfaces

Item	Model	Description	Ship	M.A.P.
Ⓞ 755267	FLAG032	MAS FLAG resin (quart)	3 lbs	\$36.39
Ⓞ 755268	FLAG064	MAS FLAG resin (1/2 gallon)	5 lbs	65.51
Ⓞ 752378	FLAG1G	MAS FLAG resin (gallon)	10 lbs	97.75

**PUMP KIT** Pre-calibrated for easy use. Fits pint through 5 gallon containers.

754998	30-016	Resin and hardener pump kit (2 each)	1 lbs	\$15.75
--------	--------	--------------------------------------	-------	---------

**READ THIS!**

Some manufacturers only allow us to print the M.A.P. (Minimum Advertised Price) in our catalog even though we may sell for less. Call 800 628-8225 or check our website for our low, current selling prices.

**Hardeners** The 3 "NO-BLUSH" hardeners are blendable to match any shop conditions. Blended hardeners work with Low Vis. or FLAG resin keeping the 2:1 ratio.

**SLOW HARDENER** • Not recommended for use below 65° F unless extended cure time is available. • Min. working temp.: 50°F • Pot life @ 70°F: 30 min. • Min 4 hour working time at 70°F

Item	Model	Description	Ship	M.A.P.
Ⓞ 751060	30-006	MAS slow hardener (pint)	2 lbs	\$32.75
Ⓞ 751062	30-007	MAS slow hardener (quart)	3 lbs	51.31
Ⓞ 751065	30-026	MAS slow hardener (1/2 gallon)	5 lbs	96.09
Ⓞ 754328	30-008	MAS slow hardener (1 gallon)	9 lbs	162.70

**MEDIUM HARDENER** • Min. working temp.: 41°F • Pot life @ 70°F: 15 min. • Min 3 hour working time at 70°F

Item	Model	Description	Ship	M.A.P.
Ⓞ 752379	30-516	MAS medium hardener (pint)	2 lbs	\$32.75
Ⓞ 752380	30-532	MAS medium hardener (quart)	3 lbs	51.31
Ⓞ 752381	30-564	MAS medium hardener (1/2 gallon)	5 lbs	96.09
Ⓞ 755263	30-FLAG-MEDIUM	MAS FLAG medium handy repair kit	2 lbs	51.31

16 oz. MAS FLAG resin, 8 oz. MAS medium hardener, (4) graduated mixing containers, (10) mixing sticks, (4) pairs of polyethylene gloves

**FAST HARDENER** • Min. working temp.: 41°F • Pot life @ 70°F: 10 min. • Min 2 hour working time at 70°F

Item	Model	Description	Ship	M.A.P.
Ⓞ 755243	30-611	MAS fast hardener (pint)	2 lbs	\$32.75
Ⓞ 755244	30-612	MAS fast hardener (quart)	3 lbs	51.31
Ⓞ 755245	30-625	MAS fast hardener (1/2 gallon)	5 lbs	96.09

Call Defender at 800-628-8225 for pricing on 4, 5, 15, 27.5 and 30 gallon resin containers.

**FILLERS**

755264	25-001	Fumed colloidal silica for thickening (1 qt)	1 lbs	\$15.59
752382	25-020	Wood flour - for wood gluing applications (1 qt)	1 lbs	14.19
Ⓞ 752385	25-005	Milled fibers - chopped 1/32" fiberglass for structural applications (1 qt)	2 lbs	29.47
Ⓞ 755265	25-007	Phenolic micro balloons for fairing (1 qt)	1 lbs	27.29
751645	25-002	Colloidal silica for structural bonding, filleting, filling (1/2 gal)	1 lbs	22.92

## West Systems Epoxies, Hardeners & Additives



### SIX10® THICKENED EPOXY ADHESIVE

This is a two-part, thickened epoxy adhesive in a convenient, self-metering cartridge used for permanent, waterproof, structural gap-filling and gluing. Bonds to wood, fiberglass, metals and masonry. Apply using a standard caulking gun. Working time is 42 minutes at 72°F; cures to a solid in 5-6 hours and takes high loads in 24 hours. Contains 190 ml of resin and hardener.

Ⓞ Item 751684	610	Ship 1 lbs	M.A.P. \$24.12
---------------	-----	------------	----------------

### STATIC MIXER TIP

Attaches to the Six10 cartridge. Thoroughly mixes the two part adhesive making it easy to lay down a bead of thickened epoxy adhesive right where you need it.

Item 753901	Model 600-2 (2) pack	Ship 1 lbs	M.A.P. \$4.10
Item 753902	Model 600-12 (12) pack	1 lbs	21.64



### WEST SYSTEM® G/FLEX EPOXY

A toughened, versatile epoxy for permanent, waterproof bonding of fiberglass, ceramics, metals, plastics, damp and difficult-to-bond woods.

Item	Model	Description	Ship	M.A.P.
Ⓞ 752813	650-8	Two 4 oz. bottles of liquid epoxy (one 4 oz. resin and one 4 oz. hardener) in a plastic bag	1 lbs	\$24.77
Ⓞ 752814	650-K	This kit contains 4 fl. oz. G/flex 650 resin, 4 fl. oz. G/flex 650 hardener (8 fl. oz. mixed epoxy), (2) reusable mixing stick/applicators, (2) 12-cc syringes, 4 grams adhesive filler, (2) mixing cups, (2) pair disposable gloves and complete handling and repair instructions	2 lbs	35.00
Ⓞ 752815	655-K	Repair plastic canoes, kayaks and inflatables made from HDPE, DPE, ABS PVC or polycarbonate plastic. Kit contains 8.4 oz. of pre-thickened G/flex epoxy, gloves, mixing pallets and mixing sticks	1 lbs	35.00
Ⓞ 756538	655-2	Repair plastic, fiberglass, ceramics, metals and wood. (2) 1 quart bottles (64 ounces total yield). Mixed at a 1:1 ratio, G/flex 655 gives you 45 minutes of working time at room temperature. Reaches an initial cure in 7 to 10 hrs and full cure in 24 hrs	5 lbs	97.05

### WEST SYSTEM HANDY REPAIR PACK

Includes WEST SYSTEM 105 resin and 205 hardener, enough high-density filler to complete a variety of coating and bonding operations, an application brush, mixing stick, pipe cleaner, two cleaning pads, disposable mixing package, 2" x 10" piece of 9 oz. fiberglass tape and instructions.

Ⓞ Item 751387	101	Ship 1 lbs	M.A.P. \$16.37
---------------	-----	------------	----------------

### WEST SYSTEM FIBERGLASS REPAIR KIT

Useful for a wide variety of fiberglass repairs including repair of cracks, scrapes, loose hardware, blisters, delaminated panels, holes, keel damage and more. Kit contains eight pre-measured packets of 105 epoxy resin and 205 fast hardener (19.2 g mixed), adhesive filler, fairing filler, mixing cups, fiberglass fabric, reusable mixing stick/applicator, syringe, two coating brushes, three pairs disposable neoprene gloves and complete instructions.

Ⓞ Item 756582	105-K	Ship 1 lbs	M.A.P. \$35.00
---------------	-------	------------	----------------



### EPOXY RESINS AND HARDENERS



**105 Resin** Translucent, pale Yellow, low-viscosity, epoxy resin formulated to be cured in a wide temperature range to form a high-strength solid with excellent moisture resistance. Wets out and bonds with wood fiber, fiberglass, reinforcing fabrics and a variety of metals. Fills gaps and bridges voids when modified with fillers and can be sanded when cured.

**205 Hardener** - General purpose hardener used in a majority of situations for bonding and coating applications. 5:1 ratio  
• Min. working temp.: 40°F • Pot life @ 72°: 9-12 min.

**206 Slow Hardener** - General purpose hardener used in warm temperatures or when a slower cure is desired at room temperature. 5:1 ratio  
• Min. working temp.: 60°F • Pot life @ 72°: 20-25 min.

**207 Special Coating Hardener** - Used when an extremely clear, natural wood finish is desired. Cures to light Amber color. 3:1 ratio  
• Min. working temp.: 60°F • Pot life @ 72°: 22-26 min

**209 Extra Slow Hardener** - For extremely warm and/or humid conditions or when extended working time is desired at room temperature. 3:1 ratio  
• Min. working temp.: 70°F • Pot life @ 72°: 40-50 min.

### Quart Size (Choose resin and hardener)

Item	Model	Description	Cure time*	Size	Ship	M.A.P.
Ⓞ 750360	105-A	Resin	-	Quart	3 lbs	\$44.22
Ⓞ 750363	205-A	Standard (Fast) hardener	6-8 hrs	.44 pt.	1 lbs	22.62
Ⓞ 750366	206-A	Slow hardener	10-15 hrs	.44 pt.	1 lbs	22.62
Ⓞ 756528	207SA	Special clear hardener	10-15 hrs	.66 pt.	1 lbs	44.22

### Gallon Size (Choose resin and hardener)

Ⓞ 750361	105-B	Resin	-	.98 gal.	11 lbs	99.73
Ⓞ 750364	205-B	Standard (Fast) hardener	6-8 hrs	.86 qt.	3 lbs	48.87
Ⓞ 750367	206-B	Slow hardener	10-15 hrs	.86 qt.	3 lbs	48.87
Ⓞ 750369	207-SB	Special coating hardener	10-15 hrs	.33 gal.	4 lbs	92.62
Ⓞ 753310	209-SB	Extra slow hardener	20-24 hrs	.33 gal.	4 lbs	84.58

### 5 Gallon Size (Choose resin and hardener)

Ⓞ 750362	105-C	Resin	-	4.35 gal.	43 lbs	\$356.33
Ⓞ 750365	205-C	Standard (Fast) hardener	6-8 hrs	.94 gal.	10 lbs	162.50
Ⓞ 750368	206-C	Slow hardener	10-15 hrs	.94 gal.	9 lbs	162.50
Ⓞ 753311	209-SC	Extra slow hardener	20-24 hrs	1.45 gal.	13 lbs	262.27

\* Cure time to solid state

### 422 BARRIER COAT ADDITIVE

Improves epoxy's moisture-exclusion effectiveness. Helps prevent gelcoat blistering and increases the epoxy's abrasion resistance. Cures to a light Color: Gray.

Ⓞ Item 750416	Model 422-16	Size 16 oz.	Ship 2 lbs	M.A.P. \$28.39
---------------	--------------	-------------	------------	----------------

### 423 GRAPHITE POWDER

Fine black powder that can be mixed with epoxy to produce a low-friction exterior coating with increased scuff resistance and durability. Cures to Black color.

Ⓞ Item 750418	Model 423	Size 12 oz.	Ship 2 lbs	M.A.P. \$20.58
---------------	-----------	-------------	------------	----------------

### WEST SYSTEM PIGMENTS

Epoxy-based pastes used to tint epoxy mixture. 1/4 pint size.

Item	Model	Color	Size	Ship	M.A.P.
Ⓞ 750399	501-8	White	4 oz.	1 lbs	\$19.41
Ⓞ 750401	503-8	Gray	4 oz.	1 lbs	19.41



## WEST SYSTEM® Fillers

Designed for West System resins but suitable for all epoxy and polyester resins, except as noted.

### 403 MICROFIBERS

A thickening additive for polyester or epoxy resin to create a multi-purpose adhesive, especially for bonding wood and gap-filling while retaining excellent wetting/penetrating capability. Color: Off-White.



Item	Model	Size	Ship	M.A.P.	Item	Model	Size	Ship	M.A.P.
750402	403-9	6 oz.	1 lbs	\$12.84	750403	403-28	20 oz.	2 lbs	\$29.40

**404 HIGH-DENSITY FILLER** Thickening additive for hardware bonding where high-cyclic loads are anticipated for filleting and gap-filling where maximum strength is needed. Color: Off-White. For use with polyester or epoxy resin.

750404	404-15	15.2 oz.	2 lbs	\$16.90	750405	404-45	43 oz.	4 lbs	\$37.82
--------	--------	----------	-------	---------	--------	--------	--------	-------	---------

**405 FILLETING BLEND** This strong, wood-toned filler is good for use in glue joints and fillets on naturally finished wood. It mixes easily with epoxy and lets you create fillets that are smooth and require little sanding. Its color is a consistent Brown, so 405 can be used to modify the shade of other WEST SYSTEM fillers.

750406	405	11 oz.	1 lbs	\$18.78
--------	-----	--------	-------	---------

**406 COLLOIDAL SILICA** A thickening additive used to control the viscosity of epoxy or polyester, often in combination with other fillers, to control the working characteristics of an epoxy mixture. It can be used to prevent epoxy runoff on vertical and overhead surfaces, improve consistency of fairing compounds, thicken bonding adhesive when filleting and improve abrasion resistance. Very strong. Color: Off-White.

750407	406-2	1.7 oz.	1 lbs	\$12.95	750408	406-7	5.5 oz.	1 lbs	\$30.56
--------	-------	---------	-------	---------	--------	-------	---------	-------	---------

**407 LOW-DENSITY FILLER** A blended microballoon-based filler used to make fairing putties that are easy to sand or carve. Reasonably strong; cures to a dark Red/Brown color. For use with polyester or epoxy resin.

750410	407-5	4.0 oz.	1 lbs	\$19.72	750409	407-15	12 oz.	2 lbs	\$45.80
--------	-------	---------	-------	---------	--------	--------	--------	-------	---------

**410 MICROLIGHT™** Low density filler for creating a light, easily worked fairing compound especially suited for large areas. Microlight mixes with greater ease than 407 filler or microballoons and is approximately 30% easier to sand. Not recommended under dark paint or surfaces subject to high temperatures. Cures to a Tan color. For epoxy only.

750411	410-2	2.0 oz.	1 lbs	\$18.71	750412	410-7	5.0 oz.	1 lbs	\$37.23
--------	-------	---------	-------	---------	--------	-------	---------	-------	---------

## Epoxy Tools & Supplies



Item	Model	Description	Qty.	Ship	M.A.P.
750383	800-2	Foam roller covers	2	1 lbs	\$6.96
750384	801-HD	Roller frame - 3"	1	1 lbs	7.24
750385	802	Pop-out roller pan	1	1 lbs	6.10
750386	803-12	Glue brushes - 6"	12	1 lbs	6.46
750387	804-8	Mixing sticks - 3/4"	8	1 lbs	3.93
750388	805	16 oz. poly mix pot	1	1 lbs	1.53
750389	806	32 oz. poly mix pot	1	1 lbs	1.99
750390	807-2	Reusable syringes	2	1 lbs	5.50
750391	807-12	Reusable syringes	12	1 lbs	23.28
750392	808-2	Plastic spreaders	2	1 lbs	6.07
750393	808-12	Plastic spreaders	12	1 lbs	30.46
750394	810-2	Fillable caulk tubes	2	1 lbs	5.28
751685	832-4	Nitrile gloves; disposable	4 pr.	1 lbs	6.51
750128	002-898	"Epoxy How-To" DVD	1	1 lbs	20.25

### WEST SYSTEM MINI PUMPS

- For accurate metering of size A, B and C WEST SYSTEM resin and hardeners
- Calibrated to deliver the proper working ratio with one full pump stroke of resin for each one full pump stroke of hardener
- Set contains (1) resin pump and hardener pumps (reusable)

Item	754429	Model	300	Ship	1 lbs	M.A.P.	\$17.13
------	--------	-------	-----	------	-------	--------	---------

### MAS RATIO MIX AND MEASURE CUPS

- Applications: Epoxies, resins, varnishes and thinners
- Made of semi-clear plastic
- Graduated in standard and metric units for easier measuring

### SEA HAWK 30-KT EPOXY PUMP KIT

- Designed for accurately measuring resin to catalyst ratio
- | Item   | Model  | Description                                                       | Ship  | Net     |
|--------|--------|-------------------------------------------------------------------|-------|---------|
| 756375 | F30-KT | (1) R1 resin pump (1) C2/C3 catalyst pump (1) C1/C5 catalyst pump | 1 lbs | \$14.99 |



## Hawk™ Epoxy, Catalysts & Fillers by Sea Hawk

### HAWK R1 EPOXY RESIN

**R1 Epoxy Resin** - is a smooth, low-viscosity liquid epoxy resin. With a variety of Hawk epoxy catalysts (below), it can be cured under a wide range of temperatures and environmental conditions to form a high-strength plastic with superior moisture barrier characteristics.

- Premium blend, low odor epoxy resin
- Applications: general fiberglass repair and construction

Item	Model	Size	Description	Ship	Net
756354	R1-S1	1	Quart	3 lbs	\$27.99
756355	R1-S2	2	1 Gallon	11 lbs	74.99
756356	R1-S3	3	4.35 Gallons	43 lbs	296.99



### SEA HAWK C2 SLOW CATALYST

- For use with HAWK EPOXY R1 resin for construction and repairs with superior adhesion, strength, bonding, filling and moisture barrier qualities (Do not use under Sea Hawk marine wood varnish.)
- For use at higher temperatures and for a slow cure
- Minimum temp: 60° F
- Working time: 90-110 mins\*
- Pot life: 20-25 mins
- Mix ratio resin/catalyst: 5:1

Item	Model	Size	Description	Ship	Net
756360	C2-S1	1	0.4 Pint	1 lbs	\$15.99
756361	C2-S2	2	0.8 Quart	2 lbs	33.99
756362	C2-S3	3	0.87 Gallon	9 lbs	117.99



### SEA HAWK C3 FAST CATALYST

- For use with HAWK EPOXY R1 resin for construction and repairs with superior adhesion, strength, bonding, filling and moisture barrier qualities (Do not use under Sea Hawk marine wood varnish.)
- For use at cooler temperatures and for a fast cure
- Minimum temp: 40° F
- Working time: 60-70 mins\*
- Pot life: 9-12 mins
- Mix ratio resin/catalyst: 5:1

Item	Model	Size	Description	Ship	Net
756363	C3-S1	1	0.4 Pint	1 lbs	\$15.99
756364	C3-S2	2	0.8 Quart	3 lbs	33.99
756365	C3-S3	3	0.87 Gallon	9 lbs	117.99



### SEA HAWK C1 ULTRA SLOW CATALYST

- For use with HAWK EPOXY R1 resin for construction and repairs with superior adhesion, strength, bonding, filling and moisture barrier qualities (Do not use under Sea Hawk marine wood varnish.)
- For use at higher temperatures and for an ultra slow cure
- Minimum temp: 70° F
- Working time: 3-4 hrs\*
- Pot life: 40-50 mins
- Mix ratio resin/catalyst: 3:1

Item	Model	Size	Description	Ship	Net
756357	C1-S1	1	.66 Pint	1 lbs	\$25.99
756358	C1-S2	2	.33 Gallon	4 lbs	60.99
756359	C1-S3	3	1.45 Gallon	16 lbs	186.99



### SEA HAWK C5 CLEAR FINISH CATALYST

- For use with HAWK EPOXY R1 resin for very clear fiberglass cloth and coating applications with exceptional moisture barrier qualities (May be used under marine wood varnish.)
- Perfect for natural wood and carbon fiber clear coats with no blush
- For use in very warm temperatures and with longer working times
- Minimum temp: 60° F
- Working time: 110-130 mins\*
- Pot life: 22-27 mins
- Mix ratio resin/catalyst: 3:1

Item	Model	Size	Description	Ship	Net
756366	C5-S1	1	0.66 Pint	1 lbs	\$31.99
756367	C5-S2	2	0.33 Gallon	4 lbs	65.99
756368	C5-S3	3	1.45 Gallon	16 lbs	199.99



\*Epoxy cures faster at higher temperatures and in thicker applications.

### SEA HAWK ADHESIVE FILLERS

Item	Model	Size	Description	Ship	Net
756868	F1-S	15.2 oz	<b>F1 High Load Adhesive Fiber Filler</b> - Thickens to a light Gray color, creating an easy-to-use adhesive designed for bonding hardware and other applications with dissimilar materials	2 lbs	\$13.99
	F1-M	43 oz		3 lbs	31.99
756869	F2-S	1.7 oz	<b>F2 Structural Adhesive Filler</b> - Thickens to an off-White color, creating a general purpose thickening additive for bonding, gap filling and filleting	1 lbs	10.99
	F2-M	5.5 oz		1 lbs	26.99
756870	F3-S	6 oz	<b>F-3 Light Density Adhesive Micro Fiber Filler</b> - Thickens to an off White color (great for bonding many substrates, especially wood)	1 lbs	10.99
	F3-M	20 oz		2 lbs	26.99
756372	F4-S	6 oz	<b>F4 Bridging Adhesive Filler</b> - Thickens to a Brown color, creating an easy-to-use adhesive with excellent gap filling and filleting qualities	1 lbs	14.99
756871	F5-S	4 oz	<b>F5 Light Density Fairing Filler</b> - Thickens to a Reddish Brown color, achieving an easy-to-sand and carve fairing compound while still remaining strong and light weight	1 lbs	15.99
	F5-M	12 oz		1 lbs	39.99
756872	F6-S	4 oz	<b>F6 MicroSphere Fairing Filler</b> - Thickens to a White color, creating a lightweight fairing compound for small to large areas (holds a feathered edge very well and is suitable for nearly every substrate)	1 lbs	14.99
	F6-M	12 oz		2 lbs	31.99

# SYSTEM THREE



## SILVERTIP GELMAGIC™

GelMagic is a toughened, non-sagging, two component, structural 2:1 epoxy adhesive designed for superior bonding to wood and most porous materials. It starts as two self-leveling liquids which form a soft, sag-resistant paste when mixed. It can be applied to vertical and overhead surfaces without running. It has high peel strength and employs a two-phase epoxy morphology which creates an adhesive bond that is tough and resistant to embrittlement. GelMagic can be post-cured up to 140°F for even greater performance.

Item	Model	Size	Ship	Net
Ⓞ 756776	1230K40	1.5 Pint	2 lbs	\$31.99
Ⓞ	1230K42	1.5 Quart	4 lbs	55.99

## QUICK CURE 5 MINUTE EPOXY

Quick Cure 5 is ideal for small jobs requiring a strong bond and rapid cure and is highly water resistant but not waterproof. Quick Cure is thick but is easily measured by squeezing equal sized lumps from the application bottles or from the u-TAH cartridge. Mix at a 1:1 by volume ratio.



Item	Model	Size	Ship	Net
Ⓞ 756774	1000K91	8.4 Oz. u-TAH cartridge	1 lbs	\$18.99
Ⓞ	1000K10	Total yield 1 Pint	1 lbs	16.99
Ⓞ	1000K14	Total yield 1 Quart	2 lbs	29.99
Ⓞ 751005	3661S99	u-TAH mixing tips (6 pack)	1 lbs	12.99

## T-88 STRUCTURAL EPOXY ADHESIVE

T88 is a high-performance, non-brittle, two-part epoxy adhesive designed to give superior results under adverse conditions. It may be used without modifications in normally fitted joints and will cure in any thickness without shrinkage. T-88 is clear Amber and becomes virtually invisible when varnished. T-88 exhibits outstanding adhesion and permanence on a wide variety of materials. 1:1 mix ratio.



Item	Model	Size	Ship	Net
Ⓞ 756775	1100K91	8.4 Oz. u-TAH cartridge	1 lbs	\$20.99
Ⓞ	1100K16	1 Quart	3 lbs	39.99
Ⓞ 751005	3661S99	u-TAH mixing tips (6 pack.)	1 lbs	12.99

## SILVERTIP QUIKFAIR™ FAIRING PUTTY

Lightweight, microballoon-filled, fast-curing two-part epoxy fairing putty with excellent moisture resistance. The two color-coded parts have a non-sagging, butter-like consistency and are easily mixed to form a third color. At 77°F QuikFair is sufficiently cured to be hand-sanded in 3 hours or machine sanded in 4 hours. Use above or below waterline.



Item	Model	Size	Ship	Net
Ⓞ 756777	1400K06	4.5 Ounce kit	1 lbs	\$11.99
Ⓞ	1400K40	1.5 Pint	2 lbs	29.99
Ⓞ	1400K42	1.5 Quart kit	3 lbs	38.99
Ⓞ	1400K46	1.5 Gallon kit	12 lbs	142.99

## GENERAL PURPOSE EPOXY

This epoxy has excellent pot life and cure-time control. When selecting a hardener, consider the minimum temperature expected during application and the required pot life. Combine different general purpose epoxy hardeners to provide a continuous range of cure times. 2:1 ratio.



Item	Model	Size/Description	Ship	Net
Ⓞ 750988	0100A16	Epoxy resin, 1 Quart	3 lbs	\$31.99
Ⓞ 750989	0101B14	FAST hardener, 1 Pint	2 lbs	21.99
Ⓞ 750990	0102B14	MEDIUM hardener, 1 Pint	2 lbs	21.99

## HI-BOND General Purpose Polyester Resin

For use in repair of small areas and decks. Used with cloth, mat, roving, etc. Hardener included. Does not contain wax. Approximate gallon coverage: 30 sq. ft. (with 1.5 oz. mat).



Item	Model	Size	Ship	Net
Ⓞ 756820	700197	Quart (32 oz.)	3 lbs	\$19.99
Ⓞ	700198	Gallon (8 lbs)	9 lbs	44.99
Ⓞ	700199	5-Gallon pail (40 lbs)	43 lbs	179.99
Ⓞ 754239	100602	1 cc tube catalyst/hardener for qt	1 lbs	4.99
Ⓞ 754240	100603	(2) 22 cc tubes catalyst/hardener for gallon	1 lbs	7.99

Note: Lower temperatures may require additional catalyst/hardener.

## HI-BOND White Gel Coat with Wax

Hi-Bond is a White gel coat designed to be used over fiberglass surfaces. This product is designed to cure to a tack-free finish. Sanding is required between coats where applicable. Contains Wax-Sol. Hardener included. Approximate gallon coverage is 75 sq. ft. @ 20 mils thick.



Item	Model	Size	Ship	Net
Ⓞ 756821	701490	Quart	4 lbs	\$28.99
Ⓞ	701500	Gallon	12 lbs	73.99

## SILVERTIP LAMINATING RESIN

A medium-low viscosity epoxy resin system optimized for coating and reinforcing fabric saturation in wood-composite boatbuilding. For use with fiberglass, Kevlar®, Dynel® graphite and bare wood. It has superior wet-out characteristics with little tendency to foam or trap air. Used in a 2:1 volumetric ratio, the working time is longer than most boat building epoxies without extending cure time. The blush-free cured film is tough and resilient with better heat resistance than other epoxies cured at room temperature. Can be combined with fillers, wood flour and bulking agents.

Item	Model	Description/Size	Ship	Net
Ⓞ 750982	0900A24	Laminating resin, 1 Gallon	10 lbs	\$86.99
Ⓞ 750984	0900B20	FAST epoxy hardener, .5 Gallon	5 lbs	76.99
Ⓞ 750986	0901B20	SLOW epoxy hardener, .5 Gallon	5 lbs	79.99
Ⓞ 750983	0900A30	Laminating resin, 5 Gallon	51 lbs	360.99
Ⓞ 750985	0900B28	FAST epoxy hardener, 2.5 Gallon	23 lbs	262.99
Ⓞ 750987	0901B28	SLOW epoxy hardener, 2.5 Gallon	24 lbs	262.99

## CLEAR COAT™ LAMINATING RESIN

Extremely low viscosity, water White, "penetrating" epoxy system. Cures to a brilliantly clear, tough finish without the "amine blush." Contains no volatile solvents. Ideal for clear coating-wood and the wetting out of fiberglass cloth. Use as a build coat for clear linear polyurethane or varnish coatings and as a penetrating first coat for blister repair. Each kit contains 2-parts resin and 1-part hardener.



Item	Model	Size	Ship	Net
Ⓞ 756773	0600K40	1.5 Pint kit	2 lbs	\$36.99
Ⓞ	0600K42	1.5 Quart kit	4 lbs	64.99

## MIRRORCOAT®

Mirrorcoat is a pourable, self-leveling bar and tabletop coating which works well on many surfaces such as wood, ceramics, plaster, masonry and some plastics. It cures to a glossy, smooth finish that is scratch and stain resistant. Cured MirrorCoat is waterproof and unaffected by alcohol. Use on bar tops and tables, decoupage coating on cloth, leather, photos, etc. Each kit contains 2-parts resin and 1-part hardener.



Item	Model	Size	Ship	Net
Ⓞ 756772	0500K42	1.5 Quart kit	4 lbs	\$60.99
Ⓞ	0500K46	1.5 Gallon kit	15 lbs	174.99

## MAS TABLE TOP EPOXY RESIN KIT

- Two-part resin / Hardener kit, Mix ratio: 1:1
- Provides a thick glass-like finish with just one pour
- Self-leveling
- Compatible with wood, metal, concrete and other surfaces



Item	Model	Total Volume	Coverage @ 1/8" Thick	Ship	Net
Ⓞ 756896	30-270	1/2 Gallon	6 square ft.	5 lbs	\$39.99
Ⓞ	30-260	Gallon	12 square ft.	10 lbs	79.99

## MAS GLUZILLA ADHESIVE / FILLER

- Two component epoxy adhesive easily dispensed from a standard caulk gun
- Adheres to wood, metal, concrete, fiberglass, stone, steel, aluminum and more
- Use as a sealant for oil, water, tanks, cellar cracks, plumbing and more
- Can be used as a filler for holes, castings, patterns, molds, voids, welds and more



Ⓞ 756395	35-100	185 ml	Ship 1 lbs	Net \$23.09
----------	--------	--------	------------	-------------

## MAS CRACKZILLA EPOXY FILLER

- Two component translucent epoxy adhesive easily dispensed from a standard caulk gun
- Adheres to all types of material. Best on concrete, cement, composites and brick
- Use as a sealant for sidewalks, seams, door frames, garage floors, steps and more
- Can be used as a filler for holes, seams, cracks and more

Ⓞ 756397	35-110	185 ml	Ship 1 lbs	Net \$23.09
----------	--------	--------	------------	-------------

## Evercoat One Step Finish Premium GelKote

A resilient, isophthalic polyester coating which does not require PVA, the use of a mold release or any other air inhibitor to cure to a hard surface. Has added ultraviolet inhibitors to increase weathering stability. For use with pigments below. Color: White.



Item	Model	Size	Ship	Net
Ⓞ 756847	105670	Pint	2 lbs	\$30.99
Ⓞ	105671	Quart	3 lbs	51.99

## Resin Pigments

Popular non-fading coloring agents for polyester and epoxy resins, gelcoats and resin based putties. Colors may be mixed to match shades. Use 1 to 2 oz. per qt., 4 to 6 oz. per gallon.

Item	Color	Size	Ship	Net
Ⓞ 755422	Specify color	1 oz.	1 lbs	\$7.99



## Epoxies, Resins & Solvents

### MARINE-TEX® EPOXY PUTTY KIT

- Handles like putty, hardens like steel, sands like wood
- Made from epoxy resins and reinforced with metal alloys for heavy duty service and tremendous strength
- Includes catalyst, resin, applicator and instructions

Item	Description	Ship	Net Ea.
ⓐ 756792	White 2 oz. kit	1 lbs	\$14.99
ⓐ 756792	White 14 oz. kit	2 lbs	34.99

### PETTIT EZ-TEX MARINE EPOXY REPAIR COMPOUND

- 100% waterproof when cured
- Excellent for filling cracks, gouges and voids
- For permanent repairs above and below the waterline

Item	Model	Size	Color	Ship	Net
ⓐ 756720	710004	4 oz.	White	1 lbs	\$14.99
ⓐ 756720	710016	16 oz.	White	2 lbs	34.99

### EVERCOAT® MARINE LAMINATING RESIN

- First coat laminating type resin for base coat applications
- Remains tacky to hold fiberglass in place on vertical surfaces
- Needs no sanding between coats
- Hardener included
- Not a finish coat

Item	Model	Size	Ship	Net
ⓐ 756793	100561	Quart	3 lbs	\$30.99
ⓐ 756793	100560	Gallon	11 lbs	82.99

### GLUVIT™ WATERPROOF EPOXY SEALER

- Provides protection for fiberglass, wood, aluminum and steel
- Seals leaky seams/rivets in aluminum hulls, fiberglass cabins, etc.
- Can be overcoated with any marine paint or coating compatible with epoxies

Item	Size/Covers	Ship	Net
ⓐ 756786	Quart/2 lbs (25-35 sq. ft.)	3 lbs	\$45.99
ⓐ 756786	Gallon/8 lbs (100-130 sq. ft.)	9 lbs	119.99

### EVERCOAT MOLD RELEASE

- Water-soluble liquid mold release forms a smooth, parting film allowing a glossy finish on molded surfaces
- Promotes complete cure of polyester gel coat

Item	Model	Size	Ship	Net
ⓐ 751127	105685	8 oz.	1 lbs	\$13.99

**KLEAN-STRIP® ACETONE** is a strong, fast-acting solvent thinner and remover for specified coatings, including polyester and epoxy resins, ink, adhesives and contact cement.

Item	Model	Description	Ship	Net
ⓐ 756798	GAC18	Gallon	8 lbs	\$18.99
ⓐ 756798	QAC18	Quart	2 lbs	7.99

### KLEAN-STRIP ODORLESS MINERAL SPIRITS

- Premium, Highly Refined Solvent, Thins Oil-Based Paints, Stains and Varnish
- Low Odor, Dries with Minimal Residue, Cleans Brushes, Tools and Equipment
- CARB\* Approved, Select Container Size.

Item	Description	Ship	Net
ⓐ 756929	Gallon	8 lbs	\$21.99
ⓐ 756929	Quart	2 lbs	8.99

**KLEAN-STRIP DENATURED ALCOHOL/STOVE FUEL** Cleans glass and is used as a fuel for marine stoves. Not intended for sale or use as a thinner.

Item	Model	Description	Ship	Net
ⓐ 756800	GSL26	Gallon	8 lbs	\$17.99
ⓐ 756800	QSL26	Quart	2 lbs	6.99

## Resin Fillers

### 3M™ MARINE HIGH STRENGTH REPAIR FILLER

For structural repairs including bonding, filling and fairing, above or below the waterline.

Item	Model	Size	Ship	Net
ⓐ 756823	46012	Pint	2 lbs	\$43.99
ⓐ 756823	46013	Quart	3 lbs	66.99

**3M MARINE PREMIUM FILLER** is a two-component vinyl ester filler formulated with unique, easy-to-sand Scotchlite glass bubbles. Designed for marine filling and fairing applications above and below the waterline.

Item	Model	Size	Ship	Net
ⓐ 756824	46004	Pint	2 lbs	\$29.99
ⓐ 756824	46005	Quart	3 lbs	52.99

### EVERCOAT FORMULA 27® ALL PURPOSE FILLER

- White plastic filler for permanent repair of dents, scrapes and gouges in fiberglass, wood, metal and concrete
- Product does not shrink, crack or pop out after curing

Item	Model	Size	Ship	Net
ⓐ 756794	100572	1/2 Pint	2 lbs	\$12.99
ⓐ 756794	100571	1 Pint	3 lbs	21.99

### EVERCOAT KITTY HAIR-RESIN

- Fiberglass filler with reinforcing fibers
- Hardener included
- Waterproof and double the strength of standard fillers
- Rebuild fiberglass and reinforce torn or rusted areas of sheet metal

Item	Model	Size	Ship	Net
ⓐ 751389	100868	1 Quart	4 lbs	\$28.99



## MagicEzy



### MAGICEZY 9 SECOND CHIP FIX™

- Nanofiller that fills, bonds, levels and colors damaged surfaces in one application
- Repairs chips, gouges, small holes, medium cracks and deep scratches on fiberglass, gelcoat, wood, ceramics, masonry, plastic\* or aluminum\*
- No sanding prep-work, mixing or color-matching required
- 3-year repair guarantee

**Specify Color:** Snow White, Oyster White, Matterhorn White, Cream, Royal Blue, Navy Blue, Midnight, Strawberry, Burgundy or Forest Green

Item	Size	Ship	Net
756339	.43 oz.	1 lbs	\$20.99

### MAGICEZY HAIRLINE FIX

- Gloss colored, one part, nano binder and sealant that fills and seals damage at both a structural and cosmetic level easily
- Perfect for gelcoat crazing, hairline cracks, non-skid deck areas, and fine scratches
- Use it on fiberglass gelcoat, wood, ceramic, plastic\* or aluminum\*

**Specify Color:** Snow White, Oyster White, Matterhorn White, Cream, Royal Blue, Navy Blue, Midnight, Strawberry, Burgundy or Forest Green

Item	Size	Ship	Net
756336	.43 oz.	1 lbs	\$20.99

\* For plastic or aluminum surfaces, prepare the surface using MagicEzy Mega Fusion

### MAGICEZY MEGA FUSION

- Quality primer/sealant with ultra powerful absorption and adhesion properties
- Prime difficult to repair surfaces such as plastic, aluminum, wood, ceramic and fiberglass
- Extraordinary adhesion power
- Penetrates deeply into pores
- Strengthens weakened surfaces
- Highly elastic to allow for structural movement
- Easy, no mess, water clean-up

Item	Size	Ship	Net
756337	.43 oz.	1 lbs	\$20.99

## Repair Kits

### EVERCOAT MATCH N' PATCH GELCOAT REPAIR KIT

Repairs scratches, gouges, cracks, etc. Kit contains: 4 fl. oz. repair paste, .25 fl. oz. liquid hardener, (6) .25 oz. tubes of color pigment, mixing cup and sticks, cleaning solvent, special release film and instructions.

Item	Model	Ship	Net
ⓐ 751405	100668	1 lbs	\$44.99



### EVERCOAT MARINE GEL COAT SCRATCH PATCH

Enables you to make repairs on hairline cracks, scratches or chips in your boat's gel coat. 1/2 oz. tube.

Item	Model	Color	Ship	Net
ⓐ 756795	105653	Buff White	1 lbs	\$13.99
ⓐ 756795	105652	White	1 lbs	13.99



### WEST SYSTEM G/FLEX EPOXY KIT

- A tough, resilient epoxy engineered for a superior grip to metals, plastics, glass, masonry, fiberglass, and wet and difficult-to bond woods.
- 4.5 oz. resin and 4.5 oz. hardener (1:1 ratio)
- 2 mixing sticks, 10 mixing palettes, gloves and alcohol pads
- More flexible than standard epoxies

Item	Model	Ship	M.A.P.
ⓐ 752815	655-K	1 lbs	\$35.00



### WEST SYSTEM G/FLEX EPOXY COMPLETE KIT

- 4 Oz. resin And 4 Oz. hardener (1:1 ratio)
- Mixing sticks & cups, syringes, colloidal silica, gloves and alcohol pads

Item	Model	Ship	M.A.P.
ⓐ 752814	650-K	2 lbs	\$35.00



### WEST SYSTEMS 105-K FIBERGLASS BOAT REPAIR KIT

- Everything to repair cracks, holes, blisters and delaminated cored panels
- Includes epoxy, fiberglass and fillers and mixing accessories
- Includes illustrated instructions for a variety of common fiberglass repairs

Item	Model	Ship	M.A.P.
ⓐ 756582	105-K	1 lbs	\$35.00



## Tools

### ES MANUFACTURING G-100 GEL COAT & RESIN CUP SPRAY GUN

- Ideal for spraying gel coat into open molds
- Includes: FN6 gel coat nozzle, micron gage, cleaning brush, cup liner and cups
- Unique, vacuum-generating nozzles allow lateral and downward spraying

Item	Model	Ship	Net
756317	G-100-6	3 lbs	\$154.99



### EVERCOAT RESIN AND FILLER SPREADERS

Set of (3) flexible, long-lasting plastic spreaders in different sizes.

Item	Model	Description	Ship	Net
751635	100381	Package of 3	1 lbs	\$5.99



**DYNEL**

◆ **Strong and versatile:** Dynel is supple and soft like a true woven fabric. It is exceptionally pliable and easily conforms to complex contours, curves and corners. The weave of Dynel is not tight to ensure ease of use. Features fast wet-out and modest texture, making it ideal for decking or cabin topping.

◆ **Excellent Adhesion:** For laminates, adhesion is essential, and Dynel is excellent: in fact, it is nearly perfect. It wets out readily and adheres well to polyester and epoxy resin. There are no voids or capillary spaces leading from the surface of laminate to serve as initial starting point for degradation. The wet-out is instantaneous when resin is applied.

◆ **Increased Durability:** Adding a layer of Dynel to the surface of a laminate as hull reinforcement provides increased resistance to abrasion, improves the laminate's ability to respond favorably on impact and resists deterioration.

◆ **Fracture Resistance:** As an overlay over glass, it preserves the surface against miniscule fractures that often occur in fiberglass gel coat.

◆ **Reduced Surface Friction:** Higher performance is attained by boats using Dynel as an overlay because the slick Dynel surface has less friction. Crazing is reduced substantially.

◆ **Low Weight/High Strength Ratio:** Dynel is relatively lightweight (5 oz. per square yard, 17 x 17 weave) in ratio to its tensile strength. Dynel can absorb workloads 6-8 times greater than glass. Dynel will have more limited physical properties when used alone rather than as an overlay. It is ideally suited for planking on larger boats that work in rough seas, provided more than a single layer is used. Decks may require several layers.

Available in continuous lengths up to 100 yds.

Item	Model	Width	Ship/3yds	Net
751414	SMA3016	60"	1 lbs	\$10.99/yd.



**KEVLAR 49 Composite Fabric**

High tensile strength and modulus combined with light weight, (Specific gravity of 1.45 versus 2.2 for fiberglass) make KEVLAR highly desirable for canoes, kayaks, racing shells and other applications where maximum strength and minimal weight are critical.

- Fabric of choice for bulletproof vests • 0.010 thick
- 4.8 oz. per square yard 17 x 17 cross weave
- Impact, tear and penetration resistance of KEVLAR is superior to fiberglass

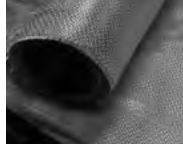

Item	Width	Length	Ship/lyd	Net
756498	38"	1-50 yds.	1 lbs	\$24.99/yd.

KEVLAR 49  
250,000 lbs/sq. in.

Stainless Steel  
250,000 lbs/sq. in.



Like Defender on Facebook for the latest boating news & information and upcoming SALE promotions!



**Vectorply Double Bias Fiberglass with Mat Baking**

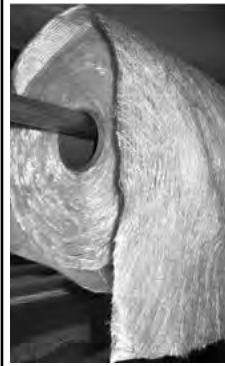

Non-crimp fiberglass fabric is the latest in high performance production grade laminate reinforcements providing: (1) higher strength-to-weight, (2) better drape and mold conformity, (3) faster wet-out, (4) smoother laminate finish and (5) higher glass-to-resin ratio. Vectorply's double bias non-crimp fiberglass fabric is made of fibers closely packed in parallel lines at 45° to the center axis and then stitch bonded to 3/4 oz. strand mat for rapid wet out and fast build-up. Yields a 15% increase in tensile and flexural strength with no increase in weight. In structures where maximum loads do not occur along or perpendicular to the center axis, non-crimp fiberglass fabric can be laid aligned with the center axis, and the resulting orientation of the fibers at 45° resists high torsional stress. Vectorply is 26 oz./sq. yd. made by stitching 18 oz. from two 9 oz. layers to mat. Suitable where lighter weight and better drape are needed or to add strength along the 45° axis. .043 thick.

Item	Model	Width	Ship/Lyds	Net
751418	EBXMC1708	50"	2 lbs	\$8.99/yd.

**Plain Fiberglass Cloth**

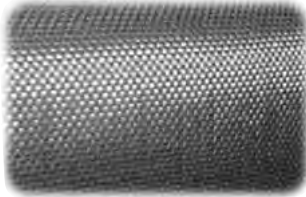

**DEFENDER IS A LEADING SUPPLIER IN THE U.S. OF MARINE-USE FIBERGLASS, REINFORCING CLOTHS AND RELATED PRODUCTS**

Fiberglass fabrics are the most common construction element in marine environments due to ease of use, durability, high strength, fire resistance and affordability. Manufactured and tested to the highest technical standards, these fabrics are treated for use with all epoxy, vinylester and polyester resins. Available in a wide range of cloth weights and widths. **Note:** Cloth weights given per square yard; prices are per linear yard.

**Fiberglass Cloth - 2.0 oz.**

.004 thick. Provides a vehicle to create a hard resin surface with minimal reinforcing. Ships 1 lb / 7 yds.

Item	Weight	Width	Price/Yd.
756384	2 oz.	50.5"	\$7.99

**Fiberglass Cloth - 6.0 oz.**

Special weight weave for small boats and weight sensitivity situations. .008 thick. Ships 1 lb / 3 yds.

Item	Width	Price/Yd.
751448	38"	\$5.99
751462	60"	7.59

**Fiberglass Cloth - 10 oz.**

.013 thick. Laminating and molding for boats 28' and under and boats up to 40' with two layers. Ships 1 lb / 2 yds.

Item	Width	Price/Yd.
751540	38"	\$9.49
751546	60"	10.99

**Woven, Chopped & Matting Cloth**

**Woven Roving Fiberglass Cloth**

Heavyweight, thick, 5 x 4 threads per inch, low tension, flat basket weave fiberglass provides thickness and strength in molding or making forms. Application and uses comparable to mat but substantially stronger. Ships 1 lbs/2 yds. average.

Model	Width	18 oz. per sq. yd.		24.5 oz. per sq. yd.	
		Item	Net/Yd.	Item	Net/Yd.
WR1	38"	754246	\$4.49	751576	\$4.49
WR2	50"	754247	5.79	751578	8.99
WR3	60"				



Woven Roving



Chopped Strand

**Combo Chopped Strand & Woven Roving Cloth**

Popular time-saver for fast build-up for molding and large structures with a minimum of laminates. 1.5 oz. strand matted to 24.5 oz. woven roving. Fabric is porous for air evacuation and easy "wet-out."

Item	Model	Width	Ship/Yd	Net/Yd.
751580	606405	38"	3 lbs	\$7.99
751583	606407	50"	4 lbs	9.99

**Fiberglass Chopped Strand Matting**

Long crisscrossed, interlocking, matted fibers provide thickness and a highly absorptive vehicle for resin work on molding boats, forms, cars, etc. Its fast "wet-out" design and even thickness make Defender's mat the finest quality in the country.

**3/4 OZ. PER SQUARE FOOT** Ships 5 yards per lbs.

Item	Model	Width	Price/Yd.
751556	1008138	38"	\$1.49

**1.5 OZ. PER SQUARE FOOT** Ships 4 yards per lbs.

Item	Model	Width	Price/Yd.
751562	1008438	38"	\$2.49

**2.0 OZ. PER SQUARE FOOT** Ships 3 yards per lbs.

Item	Model	Width	Price/Yd.
751568	1008338	38"	\$3.49



**Foam**

**HI-BOND POUR IN PLACE FOAM**

- A two-part liquid urethane, closed cell foam
- For use in hulls and cavities for flotation or insulation
- Not affected by gas or oil
- Mix ratio is 1-to-1

Item	Model	Size	Density	Displacement	Ship	Net
755677	701814	2 Gallons	4 lbs	5 cu. ft.	22 lbs	\$154.99
756343	701800	2 Quarts	2 lbs	2.5 cu. ft.	6 lbs	53.99
756344	701810	2 Gallons	2 lbs	10 cu. ft.	22 lbs	154.99



**Finishing/Strengthening/Repair Tapes**

**BI-DIRECTIONAL CARBON TAPE**

- Graphite fibers are stronger and stiffer for their weight than nearly all other engineered materials
- Graphite cloth handles like fiberglass and provides exceptional strength and stiffness
- 3" width tape with selvaged edge

Item	Model	Ship/Yd	Net/Yd
751436	0500	1 lbs	\$6.99/yd



**WEST SYSTEM® EPISIZE GLASS TAPE**

Versatile Episize 9 oz. fabric tapes are ideal for reinforcing chines, hull/deck corners and for similar structural applications. When bonded with epoxy resin, they provide additional tensile strength to resist hairline crack development and abrasion.

Item	Model	Size	Ship	M.A.P.
753312	729-10	2" x 10 ft.	1 lbs	\$11.41
751502	729	2" x 50 yds.	2 lbs	57.90
751503	731	3" x 50 yds.	3 lbs	80.53
751504	732-10	4" x 10 ft.	1 lbs	17.47
751506	732	4" x 50 yds.	4 lbs	100.52
751507	733	6" x 50 yds.	5 lbs	139.68
751508	727-10	Biaxial 4" x 10 ft.	1 lbs	16.73
751509	727-20	Biaxial 4" x 20 yds.	3 lbs	70.77



**WEST SYSTEM EPISIZE UNIDIRECTIONAL TAPES**

These tapes are easy to handle and wet out due to a polyester fill thread which ties the fiber bundles together. Tape is 11.1 oz. E-glass for strength where stiffness is less important. Carbon tape, with 144,000 fibers per inch, provides excellent strength and stiffness without much weight. Use epoxy resin only.

Item	Model	Description	Thickness	Ship	M.A.P.
750373	702-12	Carbon 1-1/2" x 12'	.015"	1 lbs	\$59.85
750374	702-50	Carbon 1-1/2" x 50'	.015"	1 lbs	157.77
750375	703-12	Carbon 3" x 12'	.015"	1 lbs	76.56
750376	703-50	Carbon 3" x 50'	.015"	2 lbs	206.40
750378	713-50	Uni-Glass 3" x 50'	.015"	2 lbs	97.13



**FIBERGLASS REPAIR TAPE**

9 oz. basket weave. Finished selvaged edge prevents unravelling. Useful for finish work, strengthening stress points, reinforcing cabin edges, gunwales, keels, rudders, etc. All ship 1 lbs/yd.

Item	Width	Net/Yd	Item	Width	Net/Yd
751473	1-1/2"	\$0.59	751488	6"	\$1.79
751485	2"	0.74	751498	8"	1.89
751486	3"	0.94	751490	12"	2.49
751487	4"	1.29			

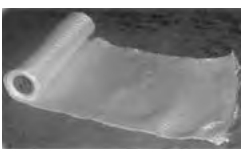

**Laminating & Caulking Tools**

**ES Manufacturing**

**DELUXE 522 ALUMINUM THIN FIN LAMINATING ROLLER**

- Roller: Aluminum
- Handle: Plastic, standard length
- Features: Superior wet out; force evenly applied to laminate area

Item	Dia	Length	Net	Item	Dia	Length	Net
756301	1/2"	3"	\$10.99	756307	1"	6"	\$14.99
756302	1/2"	6"	12.99	756308	1"	9"	19.99
756303	3/4"	3"	10.99	756309	2"	3"	16.99
756304	3/4"	6"	12.99	756310	2"	6"	19.99
756306	1"	3"	11.99	756311	2"	9"	27.99



**DELUXE 562 ALUMINUM THIN FIN RADIUS ROLLER**

Item	Dia	Length	Radius	Net
756305	1"	1-1/2"	2"	\$11.99



**DELUXE 540 ALUMINUM CORNER ROLLER**

Item	Dia	Width	Radius	Net
756312	2"	1/2"	1/4"	\$13.99
756313	2"	5/8"	3/8"	12.99
756314	2"	3/4"	1/2"	13.99



**DELUXE 790 FINNED BRISTLE ROLLER**

Item	Dia	Width	Net
756315	3"	3/4"	\$11.99
756316	Bristle roller refill (3" Dia. x 3/4"W)		7.99

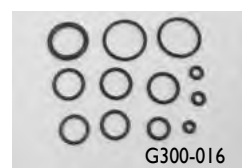

**G-100 GEL COAT & RESIN CUP SPRAY GUN**

- Applications: Ideal for spraying gel coat into open molds
- Includes: FN6 gel coat nozzle, micron gauge, cleaning brush, liner and cups
- Unique vacuum generating nozzles allow lateral and downward spraying

**SPRAY GUN O-RING REBUILD KIT**

• O-ring rebuild kit for ES Manufacturing G-100 spray gun			
Item 756320	G300-016	Ship 1 lbs	Net \$19.99

**REPLACEMENT SPRAY GUN NOZZLE**

• For ES manufacturing spray guns			
• Suitable for most gelcoats			
Item 756318	G300-FN6 Size 6	Ship 1 lbs	Net \$14.99
Item 756319	G300-FN8 Size 8	1 lbs	14.99

**CAULKING COTTON**

Used to seal seams.

Item	Model	Description	Ship	Net
751380	CCI	1 lb roll, 210'	2 lbs	\$13.49



**COTTON WICKING**

Item 755174	498	2 oz. ball	1 lbs	\$1.99
-------------	-----	------------	-------	--------



**CAULKING IRONS**

Traditional iron for installing cotton wicking.

Item	Model	Thickness	Length	Blade	Ship	Net
751383	273-00	1/32"	5"	2"	1 lbs	\$23.99
751384	273-0	1/16"	5-5/8"	2-1/2"	1 lbs	23.99
751385	273-1	1/8"	5-7/8"	2-1/4"	1 lbs	23.99



**Teakdecking Systems**

**FE-180A BONDING EPOXY**

- Maximum bond strength
- Excellent wet-out of bonding surfaces
- Best for gluing teak and teak deck panels
- Flexible strength resists shock and twists
- High viscosity holds profile to fill gaps
- 1:1 mix ratio for easy mixing
- High density fillers
- Gel time: 70 minutes
- Non-blushing
- Tinted Brown
- Open time: 120-130 minutes

Item	Model	Description	Ship	Net
756855	FE 180 A-1G	1 Gallon Kit	12 lbs	\$124.99
756856	FE 180 A-2G	2 Gallon Kit	24 lbs	209.99



**TDS SEAM SANDER KIT**

- Use to remove final caulking residue
- Specially designed and constructed for long service life, ease and speed of operation
- Made of the finest quality steel and hardwood
- Manufactured with a comfortable, smooth grip
- Includes handle, sanding surface and (6) sanding pads

Item	Model	Description	Ship	Net
755889	SEAM SA	Adjustable sanding depth from 3/16" to 7/8"	1 lbs	\$53.99
755890	REEF HO	Reefing hook	1 lbs	23.99



**FFE-200 FAIRING AND BONDING EPOXY**

A medium viscosity epoxy fairing/bonding compound blended to yield a lightweight, flexible and easily sanded system for use as both a fairing compound for uneven surfaces and in bonding of teak decks to faired surfaces.

Color: Pink Coverage: 30 ft<sup>2</sup> / gallon

Item	Model	Size	Ship	Net
756741	FFE2001QT	1 Quart	2 lbs	\$49.99
	FFE2001G	1 Gallon	10 lbs	154.99
	FFE2002G	2 Gallon	18 lbs	234.99



**SIS-440 TEAK DECK CAULKING**

- One-part polymer adhesive/sealant
- No primer necessary
- Rapid, neutral cure to tough, flexible, solid rubber compound

Item	Model	Size	Specify Color	Ship	Net
755892	SIS440	10.3 oz	Black, Gray, White	1 lbs	\$16.99
755893	CAULK 20SB	20 oz	Black	2 lbs	28.99



Ships Ground Only - No Extra Charge  
Larger Size Product, Ships at Dimensional Weight

Ships by Truck  
Hazardous Material. \$35.00 Fee and Ships Ground Only

See page 216 for teak decking cleaner.

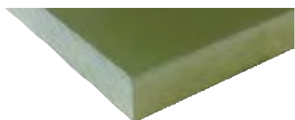

### G10 (FR-4 Flame Rated) Fiberglass Board

This material offers high mechanical strength at room temperature. It exhibits good dielectric loss and electrical strength under both dry and humid conditions. In addition, it has flame resistance of at least Class I in accordance with NEMA test method 7.11.

- Formed from epoxy resin allowing it to bond easily using most two-part epoxies
- Composite material composed of woven fiberglass cloth with an epoxy resin binder that is flame resistant (FR-4)
- Often used in the marine market due to its superior strength and moisture resistance

Item	Thickness	Prices Range From
756502	1/8"	\$14.99 - 136.99
756503	1/4"	28.99 - 240.99
756504	3/8"	39.99 - 364.99
756505	1/2"	58.99 - 439.99
756506	3/4"	78.99 - 724.99
756507	1"	93.99 - 799.99

Please Specify Size: 12 x 12", 12 x 24", 12 x 36", 12 x 48", 24 x 24", 24 x 36", 24 x 48", 36 x 36", 36 x 48"

Additional customization available by Special Order

### King Starboard Marine Lumber

King StarBoard® is the original marine-grade polymer and the industry standard. King StarBoard is environmentally stabilized to withstand the harshest marine conditions. It will not rot or discolor like teak and other solid woods, and it will not delaminate like wood laminates. King StarBoard is easy to work with using standard woodworking tools and design changes are a snap. King StarBoard has a matte finish on both sides to hide scuffs and scratches.



#### 1 1/4" Black or White only

Item	Color	Dimensions	Ship	Net
756785	White	6" x 12" x 1/4"	1 lbs	\$11.99
	White	12" x 12" x 1/4"	2 lbs	15.99
	Specify Black or White	12" x 27" x 1/4"	3 lbs	26.99
	Specify Black or White	24" x 27" x 1/4"	6 lbs	42.99
	Specify Black or White	24" x 54" x 1/4"	12 lbs	43.99

#### 1 1/2" Black, White or Seafoam

756825	Specify Black, White or Seafoam	12" x 27" x 1/2"	6 lbs	41.99
	Specify Black, White or Seafoam	24" x 27" x 1/2"	12 lbs	71.99
	Specify Black, White or Seafoam	24" x 54" x 1/2"	23 lbs	134.99
	Specify Black, White or Seafoam	54" x 96" x 1/2"	103 lbs	374.99

#### 3/4" Black, White or Seafoam

756827	Specify Black, White or Seafoam	24" x 27" x 3/4"	18 lbs	113.99
	Specify Black, White or Seafoam	24" x 54" x 3/4"	34 lbs	120.99
	Specify Black, White or Seafoam	54" x 96" x 3/4"	136 lbs	419.99

#### KING STARLITE XL

King StarLite® XL is an economical cellular (closed cell) utility sheet. It is ideal for boat parts, as an upholstery substrate and in other behind-the-scenes applications where edges aren't visible. King StarLite XL is up to 35% lighter in weight than King StarBoard, and it offers the same quality textured surface on both sides.



Item	Color	Dimensions	Ship	Net
756826	Utility Gray	24" x 60" x 1/2"	17 lbs	\$69.99
	Utility Gray	96" x 60" x 1/2"	70 lbs	262.99

#### KING STARBOARD XL

High density polyethylene cap and a closed cellular inner core. It has an excellent surface finish that looks good enough to use in high visibility applications where structural strength and a finished edge are not important.



Item	Color	Dimensions	Ship	Net
756656	White	24" x 60" x 1/2"	16 lbs	\$94.99

#### KING STARBOARD ANTI-SKID

A sure-grip, marine-grade decking material designed specifically for high-traffic areas. This unique product features a special high-friction surface polymer and dot pattern to prevent slipping and promote drainage.



Item	Color	Dimensions	Ship	Net
756783	White	12" x 27"	6 lbs	\$39.99
756655	White	24" x 54" x 1/2"	23 lbs	99.99
756654	Specify White or Seafoam	24" x 54" x 3/4"	35 lbs	138.99

### Starboard Adhesive

#### MARINE-TEX FLEXSET FLEXIBLE EPOXY ADHESIVE

Non-sagging, non-shrinking. Bonds to polyethylene Starboard and marine lumber, PVC, Hypalon/CSM, rubber, polyurethane, acrylic, fiberglass, polycarbonate, wood, ABS, aluminum, Lexan® and dissimilar materials. Apply above or below the waterline, in wet or dry areas.

Item	Size	Color	Ship	Net
Ⓞ 752399	30 grams	Sand-White	1 lbs	\$21.99



### Baltek

#### Baltek SB ContourKore

- Baltek SB is a core material produced from select kiln-dried balsa wood in the end-grain configuration
- When balsa wood is cut perpendicular to the grain direction it has optimum physical properties due to its honeycomb-like cell structure
- Extremely low specificweight
- High mechanical rigidity and stiffness
- Reduced use of raw materials
- Great for ship and boat construction (hull, decks, bulkheads, superstructures, interior fittings)
- Compatible with polyester, vinylester or epoxy resins and glass, DuPont™ KEVLAR® or carbon fibers
- Sandwich structures with balsa result in a particularly lightweight and sturdy end product
- Depending on processing and in combination with other layers, Baltek® core material has other interesting properties:
  - Excellent flexural, bond & shear strengths
  - Requires less resin to wet out than cellular foam cores
  - Includes fiberglass scrim for contour ability
  - Certified & approved for marine use
  - High specific stiffness and rigidity
  - Excellent moisture resistance
  - Excellent sound absorption and thermal insulation
  - Operating temperature from -212° C to +163° C
  - Sheet size: 24" x 48" with fiberglass scrim for contour ability.
- High strength-to-weight ratio
- Pre-wetting not necessary
- Excellent fire behavior
- Excellent fatigue resistance
- High impact resistance



Item	Size	Ship	Net
752557	3/8" thick	3 lbs	\$29.99
752559	1/2" thick	4 lbs	34.99
752561	5/8" thick	4 lbs	49.99
752563	3/4" thick	6 lbs	46.99
752564	1" thick	7 lbs	59.99

#### Seateak Teak Lumber

- Teak wood is often used in marine applications, boatbuilding, furniture and flooring
- Color and grain pattern will vary making your piece unique
- Teak is a very durable hardwood with excellent split resistance
- Often chosen for its beautiful Olive-Brown or Yellow-Brown color which will become more golden as time progresses



Item	Model	Description	Ship	Net
756094	60808	3/8" x 5-3/4" x 12"	1 lbs	\$13.99
756095	60809	3/8" x 5-3/4" x 36"	2 lbs	34.99
756096	60810	3/8" x 5-3/4" x 60"	4 lbs	55.99
756097	60811	1/2" x 1-3/4" x 30"	1 lbs	12.99
756098	60812	1/2" x 1-3/4" x 36"	1 lbs	13.99
756099	60813	1/2" x 1-3/4" x 72"	2 lbs	27.99
756100	60814	7/8" x 7/8" x 30"	1 lbs	11.99
756101	60815	7/8" x 1-3/4" x 48"	2 lbs	23.99
756102	60816	7/8" x 3-3/4" x 12"	1 lbs	14.99
756103	60817	7/8" x 3-3/4" x 3-7/8"	1 lbs	10.99
756104	60818	7/8" x 4" x 36"	3 lbs	30.99

### CoreMat

- Non-woven polyester fibers with microspheres designed to be impregnated with resin to provide added thickness of isotropic laminates
- Use between layers of glass, providing up to 55 to 75% of thickness
- Allows for a very rapid buildup compared to conventional glass/resin lamination
- Extraordinary aspect of low density with high flexural rigidity
- Further buildup can be accomplished with added roving fiberglass
- No heat required
- Material easily cuts to exact size with scissors or knife
- Edges butted to ensure equal thickness and flat surface
- Width: 39"
- Ships 2-3 yards/lb.

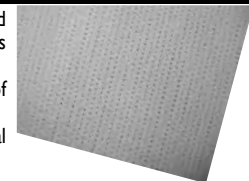

Item	Model	Thickness	Net/yd
752644	CM3	3 mm (.120")	\$8.99
752647	CM4	4 mm (.160")	13.99

- Ⓞ Ships Ground Only - No Extra Charge
- 🚚 Ships by Truck
- D Larger Size Product, Ships at Dimensional Weight
- ⚠ Hazardous Material. \$35.00 Fee & Ships Ground Only



## Myerchin Rigging Knives



TF300/TF300P



AF300/AF300P

### GEN 2 TITANIUM SERIES - TITANIUM HANDLE • FOLDING BLADE

- Improved smooth one-hand open
- "Springless" double-locking mechanism
- Belt clip and nylon sheath
- Classic sheepfoot blade with shackle slot

**CAPTAIN** Blade length: 2.8"; Length closed: 4.75"

**Please specify:** Standard or serrated stainless steel blade

Item	Model	Blade & Spike Open	Spike	Ship	Starting At
608966	TF300/TF300P	11"	3"	1 lbs	\$98.99

**CREW\*** Blade length: 2.3"; Length closed: 3.5"

**Please specify:** Standard or serrated stainless steel blade

Item	Model	Blade & Spike Open	Spike	Ship	Starting At
608967	TF377/TF377P	8.2"	1.75"	1 lbs	\$77.99



BF300

B100/  
B100P

### GEN 2 G10 HANDLE • FOLDING BLADE Glass fiber reinforced handle

- Improved smooth one-hand open
- "Springless" double-locking mechanism
- Belt clip and nylon sheath
- Classic sheepfoot blade with shackle slot

**CAPTAIN** Black G10 handle; blade length: 2.8"; Length closed: 4.75"

**Please specify:** Standard or serrated stainless steel blade

Item	Model	Blade & Spike Open	Spike	Ship	Starting At
608966	BF300/BF300P	11"	3"	1 lbs	\$73.99

**CREW\*** Black G10 handle; Blade length: 2.3"; Length closed: 3.5"

**Please specify:** Standard or serrated stainless steel blade

Item	Model	Blade & Spike Open	Spike	Ship	Starting At
608967	BF377/BF377P	8.2"	1.75"	1 lbs	\$57.99

### GEN 2 G10 OFFSHORE SYSTEM • FIXED BLADE

- Heavy duty leather sheath
- Classic sheepfoot blade with shackle slot
- Blade length: 3.8"
- Spike length: 6.65"

Item	Model	Handle	Blade	Ship	Starting At
608968	W100/W100P	Wood	Standard or Serrated	2 lbs	\$83.99
	B100/B100P	Black*	Standard or Serrated	2 lbs	82.99
	A100/A100P	White*	Standard or Serrated	2 lbs	77.99

\*G10 Glass fiber reinforced handle

## Wichard Rigging Knives

### WICHARD AQUATERRA FOLDING KNIFE

- Stainless steel blade
- Soft grip handle
- Blade length: 3-5/32"; Length closed: 4-17/32"

**Specify Color:** Black, Blue or Red

Item	Blade Type	Ship	Net
550855	Straight	1 lbs	\$20.99
550856	Serrated	1 lbs	23.99
550857	Straight w/corkscrew	1 lbs	27.99

### WICHARD OFFSHORE FOLDING KNIFE

- Stainless steel blade
- Soft grip handle
- Blade length: 3-5/32"; Length closed: 4-17/32"

**Specify Color:** Blue, Orange or Day Glow

Item	Blade Type	Ship	Net
550858	Serrated	1 lbs	\$27.99
550859	Straight w/shackle key	1 lbs	46.99

### WICHARD FORGED SHACKLE KEY

- Stainless steel
- Accepts up to 1/2" shackles
- Includes bottle opener and hole for attachment to lanyard or key chain

Item	Model	Ship	Net
607644	10303	1 lbs	\$17.99

## Sea-Dog Rigging Knife

### SEA-DOG RIGGING KNIFE

- Folding blade
- Blade type: Straight
- Stainless steel
- Length 3-11/16" closed
- 2-1/2" blade length
- Includes sharp straight blade, marlin spike, shackle key, screwdriver, bottle opener and loop to attach to lanyard

Item	Model	Ship	Net
613602	565050-1	1 lbs	\$14.99

## Davis Rigging Knives

### DAVIS RIGGING KNIFE

- Made of top quality stainless steel
- 2-1/5" dura-edged blades
- 3" locking marlin spike and bale loop for lanyard
- Includes shackle key and screwdriver

Item	Model	Ship	Net
612768	1551 Deluxe	1 lbs	\$19.99

### GEN 2 NATURAL BONE HANDLE • FOLDING BLADE

- Improved smooth one-hand open
- "Springless" double-locking mechanism
- Belt clip and nylon sheath
- Classic sheepfoot blade with shackle slot

**CAPTAIN** Blade length: 2.8"; Length closed: 4.75"

**Please specify:** Standard or serrated stainless steel blade

Item	Model	Blade & Spike Open	Spike	Ship	Starting At
608966	AF300/AF300P	11"	3"	1 lbs	\$118.99

**CREW\*** Blade length: 2.3"; Length closed: 3.5"

**Please specify:** Standard or serrated stainless steel blade

Item	Model	Blade & Spike Open	Spike	Ship	Starting At
608967	AF377/AF377P	8.2"	1.75"	1 lbs	\$79.99



WF300

WF300P

W100

W100P

### GEN 2 MAPLE WOOD HANDLE

- Wood and German marine stainless steel handle
- Heavy duty leather sheath
- Classic sheepfoot blade with shackle slot

**CAPTAIN • FOLDING BLADE** Blade length: 2.8"; Length closed: 4.75"

**Please specify:** Standard or serrated stainless steel blade

Item	Model	Blade & Spike Open	Spike	Ship	Starting At
608966	WF300/WF300P	11"	3"	1 lbs	\$77.99

### SAILOR'S TOOL KNIFE • FOLDING BLADE

- Improved smooth one-hand open
- "Springless" double-locking mechanism
- Folding serrated blade (3/4 serrated and 1/4 standard)
- Marlin spike (locking), pliers and lanyard loop
- Blade length: 2.25"; Closed 5"

**Color options** (Red, Blue or Silver)

Item	Model	Length Open	Spike	Ship	Net
601108	P300	9.25"	3"	1 lbs	\$34.99

\* Note: The serrated blade is 3/4 serrated and 1/4 straight.



FOR MORE DETAILED PRODUCT SPECIFICATIONS AND OUR COMPLETE SELECTION VISIT [WWW.DEFENDER.COM](http://WWW.DEFENDER.COM) OR CALL 800-628-8225

## Seachoice Tool Kit

### (76) PIECE DELUXE TOOL SET

- Made of forged chrome vanadium steel
- A must for every boater
- Contents are secured in an attaché style, tough molded carrying case

**Kit Includes:**

- (8) Combination wrenches
- (2) Screwdrivers: 1-1/2" (Phillips and slotted)
- (2) Screwdrivers: 4" (Phillips and slotted)
- (1) 1/2" drive spark plug socket
- (1) 1/2" drive ratchet handle (10")
- (1) Screwdriver 8" (slotted)
- (1) Circuit tester
- (1) 9" Crimping tool
- (30) Terminals
- (1) 9-1/2" water pump pliers
- (1) 10" extension bar
- (1) 10" sliding bar
- (6) Allen wrenches
- (1) Battery cleaning brush
- (1) 5" extension bar
- (1) 10" locking pliers
- (1) Hammer (300 g)
- (1) 1/2" drive universal joint
- (1) Gapping tool
- (13) 1/2" drive sockets

Item	Model	Ship	Net
756347	79861	14 lbs	\$75.99



## FORESPAR TEA TREE AND REFRESH FOR EFFECTIVE ODOR AND MILDEW CONTROL!



## FORESPAR TEA TREE GELS AND SPRAY

- Contains 100% pure Australian tea tree oil
- Cleans and disinfects surfaces naturally

Item	Model	Size	Ship	Net
756653	770201	2 oz. gel	1 lbs	\$14.99
	770202	4 oz. gel	1 lbs	24.99
	770203	8 oz. gel	1 lbs	37.99
756041	770207	8 oz. spray	1 lbs	14.99
756906	770273	16 oz. spray refill	1 lbs	24.99

## Re-Sealable Refill Gel Pouch

Please specify size

Item	Size	Ship	Net
756654	22 oz.	2 lbs	\$75.99
	(2) 22 oz.	3 lbs	125.99

## Mildew Products

## STAR BRITE MILDEW STAIN BLOCKER WITH NANO TECH BARRIER

- Lasts up to (3) months
- Non-toxic - Safe for people and pets
- For fiberglass, vinyl, plastic, rubber, fabric and painted surfaces

Item	Size	Ship	Net
756643	22 oz.	2 lbs	\$12.99

## STAR BRITE MILDEW STAIN REMOVER

- Remove mildew stains on contact
- For vinyl covers, headliners, cushions, etc.
- Spray on application

Item	Size	Ship	Net
755009	22 oz.	2 lbs	\$9.99

## MARYKATE MILDEW STAIN REMOVER

- No drip, no scrub formula
- Use on vinyl and hard surfaces
- Fast and effective

Item	Size	Ship	Net
751081	Qt.	3 lbs	\$10.99

## 3M MARINE MILDEW STAIN REMOVER

- Quickly removes mildew stains on vinyl, covers, cushions and other marine surfaces

Item	Size	Ship	Net
755242	16.9 oz.	2 lbs	\$14.99

## 3M MARINE MILDEW BLOCK

- Reduces mildew growth
- Safe to use on most surfaces and materials above the waterline
- Non-toxic formula keeps surfaces looking new and clean

Item	Size	Ship	Net
755045	16.9 oz.	2 lbs	\$15.99

FOR MORE DETAILED PRODUCT SPECIFICATIONS AND OUR COMPLETE SELECTION VISIT  
WWW.DEFENDER.COM OR CALL 800-628-8225

## FORESPAR REFRESH MARINE DEODORIZER

- Use on fabric, hard surfaces, refrigerators, coolers and more
- Non-staining and fast acting
- Lasts up to (3) months
- Removes almost any odor
- Works on gas and oil odors
- 1.5 oz makes 1 qt
- Non-toxic, biodegradable, child and pet safe

## Refresh Concentrate

Item	Size	Ship	Net
503284	16 oz.	1 lbs	\$33.99

## FORESPAR REFRESH MARINE HEAD AND TANK DEODORIZER

- Kills odors in head compartment and holding tank
- Non-toxic, biodegradable
- 2 oz. kills odors without chemicals for up to 4 months

Item	Size	Ship	Net
503285	16 oz.	1 lbs	\$14.99

## Dehumidifiers/Odor Control

## NOSGUARD SG® MOLD/MILDEW ODOR CONTROL BOAT BOMB

- Completely treat an area within 6 hours
- Chlorine dioxide formula
- (1) Pouch treats an area up to 1,000 cu. ft.
- Package contains: (1) 10 gram pouch and sponge delivery system

Item	Ship	Net
755647	1 lbs	\$7.99

## NOSGUARD SG MOLD/MILDEW ODOR CONTROL

- Removes and prevents mold/mildew odors
- Maintains indoor air quality
- Generates a deep-penetrating chlorine dioxide vapor that permeates 100% of treated area

Item	Description	Ship	Net
754093	Fast release, (1) 10 gram pouch	1 lbs	\$7.49
754094	Slow release, (2) 10 gram pouches	1 lbs	9.99

## MDR DAMP AWAY

- Lasts for months
- Water collects - pour off and keep using
- Will absorb 14 times its own weight

Item	Size	Ship	Net
756662	14 oz.	1 lbs	\$7.99
	Qt.	2 lbs	13.99

## STAR BRITE NO DAMP

- Dries air, stops mildew and odors
- Inner basket design increases efficiency
- 12 oz. treats up to 900 cubic feet

Item	Size	Ship	Net
751318	12 oz. bucket	1 lbs	\$6.99
751319	12 oz. refill	1 lbs	2.59
751320	48 oz. refill	4 lbs	7.99

## DAMPRID MOISTURE ABSORBER HANGING

- Fragrance free
- Lasts up to 60 days

Item	Size	Ship	Net
754651	14 oz.	2 lbs	\$5.49
756037	14 oz., (3) pack	4 lbs	11.99
756033	10.5 oz.; refillable	1 lbs	3.49
756034	42 oz. economy refill	3 lbs	5.99

## DAMPRID HI-CAPACITY MOISTURE ABSORBER

- Lasts up to 6 months for 250 ft<sup>2</sup> area

Item	Size	Ship	Net
756035	4 lbs	6 lbs	\$12.99



## Hull Polishes

## MCLUBE HULLKOTE ANTI FOUL ALTERNATIVE SPEED POLISH

- High-gloss, citrus-based polish for everything below the waterline
- Non-toxic, non-metallic and non-leaching
- Prevents marine growth and slime from adhering for weeks
- Biodegradable and environmentally friendly

Item	Size	Ship	Net
756216	16 oz.	2 lbs	\$35.99



## Hull Cleaners

## STAR BRITE EZ-ON EZ-OFF HULL CLEANER

- Simple wipe on and rinse off formula
- Contains no strong acids or harsh chemicals
- Much safer to use than competitive acid based bottom cleaners
- Contains inhibited hydrochloric acid to safely clean even the toughest stains

Item	Size	Ship	Net
754580	Qt.	3 lbs	\$9.99

Note: May discolor some antifouling bottom paints



## STAR BRITE HULL CLEANER

- No rubbing required
- Contains no harmful acids
- Excellent for use on fiberglass, metal or painted surfaces
- Removes stains from grassy marine growth, scum line, rust stains

Item	Size	Ship	Net
755023	32 oz.	3 lbs	\$13.99



## MARYKATE ON &amp; OFF HULL AND BOTTOM CLEANER

- Softens barnacle rings and zebra mussels
- Brush on, rinse off
- Removes waterline stains, algae, rust and gas exhaust
- For fiberglass only

Item	Size	Ship	Net
756668	Qt.	3 lbs	\$11.99
	Gal.	10 lbs	28.99



## MARYKATE ON &amp; OFF GEL HULL CLEANER

- Gel formula clings to surface
- Breaks down grease and oil
- Removes scum lines and stains
- Blue color makes it easy to see where the product has been applied
- For fiberglass only

Item	Size	Ship	Net
756669	32 oz.	3 lbs	\$12.99
	Gal.	10 lbs	31.99



## SEA SAFE HULL CLEANER

- Biodegradable and environmentally friendly
- Removes stains from waterlines and rust stains from all hull surfaces
- Simple to use: just wipe on and rinse off

Item	Size	Ship	Net
755393	32 oz.	3 lbs	\$15.99



## TRAC ECOLOGICAL BARNACLE BUSTER

- Removes marine growth and scale buildup in equipment cooled by sea water
- Safe, non-toxic and biodegradable
- Dissolves barnacles, zebra mussels
- Unlike concentrate, this is READY TO USE

Item	Size	Ship	Net
751627	Gal.	10 lbs	\$19.99



## TRAC ECOLOGICAL BARNACLE BUSTER CONCENTRATE

- Removes marine growth and scale buildup in equipment cooled by sea water
- Safe, non-toxic and biodegradable
- Dissolves barnacles, zebra mussels
- (1) Gallon of concentrate makes (5) Gallons of barnacle remover

Item	Size	Ship	Net
751630	Gal.	13 lbs	\$59.99



## MCLUBE HULLKOTE SPEED POLISH

- High performance coating cleans and polishes to a high-gloss finish
- Environmentally friendly with superior long-lasting UV protection
- Lasts more than one year above the waterline and more than 20 days of hard use below the waterline

Item	Size	Ship	Net
600935	16 oz.	2 lbs	\$33.99





## Boat Washes

### AWLGRIIP AWLWASH

- Wash down concentrate, formulated to clean Awlgrip, Awlgrip 2000 topcoats and other painted surfaces
- Biodegradable
- Does not contain alkalis, acids or abrasives
- Free rinsing formula leads to faster drying
- Dilution: 1 oz. Awlwash to 1 gallon water
- After washing, use Awlcare to seal & protect

Item	Size	Ship	Net
ⓐ 756660	32 oz.	3 lbs	\$23.99
ⓐ	Gallon	10 lbs	55.99

See Awlgrip Awlcare Protective Polymer Sealer on page 217.

### MEGIUAR'S BOAT WASH

- Safely removes grime and dirt
- Won't strip wax protection
- Long lasting suds
- Refreshing scent
- Biodegradable

Item	Size	Ship	Net
754299	64 oz.	5 lbs	\$10.99

### STAR BRITE SEA SAFE BOAT WASH

- Biodegradable and environmentally friendly - won't remove wax or polish
- Concentrated formula cleans dirt, stains, grease, oil and salt
- Use on fiberglass, metal, glass, rubber and painted surfaces

Item	Size	Ship	Net
755013	32 oz.	3 lbs	\$9.99



PLEASE LIKE US ON FACEBOOK!  
[FACEBOOK.COM/DEFENDERINDUSTRIES](https://www.facebook.com/DEFENDERINDUSTRIES)

### STAR BRITE BOAT WASH

- Biodegradable
- Leaves hulls, decks and chrome sparkling
- A few capfuls will clean a 20 ft. boat
- Nonstreaking - won't remove wax and polish

Item	Size	Ship	Net
756659	16 oz.	2 lbs	\$5.99
	Gallon	10 lbs	26.99

### IMAR™ YACHT SOAP CONCENTRATE

- Creates a highly polished appearance
- Non-streaking, non-spotting formula
- Rinses clear and decreases drying time
- Protects polishes while thoroughly cleaning

Item	Size	Ship	Net
ⓐ 755222	16 oz.	2 lbs	\$10.99

### 3M MARINE MULTI-PURPOSE BOAT SOAP

- Concentrated formula designed to clean anything from dirty decks to soiled fabrics
- Can even degrease engines
- Mix concentrate with water for desired cleaning strength (1 oz. to 1 gallon of water)

Item	Size	Ship	Net
755050	16 oz.	2 lbs	\$11.49

## All Purpose Cleaners

### Z-TUFF PRODUCTS Z-CLEANER

Premixed and ready to use spray

- A powerful, general all-purpose cleaner for vinyl, fiberglass, non-skid surfaces
- Works on fenders, inflatable dinghies, power cords, bilges and more
- Cleans up stains, dirt, grease, black streaks and diesel exhaust
- Z-Cleaner leaves a clean, rust inhibiting finish that resists dirt and stains

Item	Size	Ship	Net
ⓐ 755034	32 oz.	3 lbs	\$14.99

### Z-TUFF PRODUCTS Z-CLEANER CONCENTRATE

- Heavy duty concentrated cleaner
- Strong and effective
- Dilute with water before using
- Contains no bleach, chlorine or acid
- 100% biodegradable
- Environmentally safe and friendly
- Non-flammable

Item	Size	Ship	Net
ⓐ 756664	32 oz.	3 lbs	\$15.99
ⓐ	Gallon	10 lbs	28.99

### IMAR YACHT CLEAN AND SHINE SPRAY

- For exteriors or interiors
- Enhances shine and gives a "wet look"
- Removes soil, oil, film, etc.
- Contains anti-static properties to repel dust

Item	Size	Ship	Net
ⓐ 755224	16 oz.	2 lbs	\$14.99

### YACHT BRITE SERIOUS MARINE CLEANER

- Cleans fiberglass exteriors, decks, vinyl, carpet, rubber, teak and canvas
- Thoroughly cleans without damaging surrounding materials

Item	Size	Ship	Net
754958	32 oz.	3 lbs	\$16.99

### MDR KRAZY CLEAN

- Easily removes grease, grime, oil and dirt
- Wet surface, squirt, wipe off
- Biodegradable

Item	Size	Ship	Net
ⓐ 756663	24 oz.	2 lbs	\$9.99
ⓐ	32 oz.	3 lbs	10.99
ⓐ	Gallon Jug	9 lbs	26.99

Most orders placed  
 by 4:30PM ET  
 (Monday - Friday) ship  
 the same day!

800-628-8225

## Stain/Streak Removers & Preventers

### STAR BRITE RUST STAIN REMOVER

- Removes rust deposits and stains
- Spray on formula
- Safe for fiberglass, metal or painted surfaces

Item	Size	Ship	Net
ⓐ 751100	22 oz.	2 lbs	\$10.99

### STAR BRITE BLACK STREAK REMOVER

- Instantly removes black streaks
- Spray on, let work and hose off
- No harsh acids or alkalis
- Safe on fiberglass, metal and painted surfaces
- Can be used for other tough cleaning jobs such as bathrooms, tubs, showers, etc.

Item	Size	Ship	Net
755002	22 oz.	2 lbs	\$8.99

### DAVIS FSR FIBERGLASS STAIN REMOVER

- Non-abrasive
- Requires no sanding or compounding
- Apply with a brush, sponge or cloth, wait a few minutes, wipe off
- Ideal for removing oil, rust, exhaust, waterline stains, etc.

Item	Size	Ship	Net
ⓐ 756665	Pint	2 lbs	\$9.99
ⓐ	2 liters	5 lbs	25.99

### STAR BRITE SPIDER AND BIRD STAIN REMOVER

- Quickly dissolves messy spider and bird droppings
- Non-toxic, all-natural formula
- Contains no bleach
- Safe for use around children and pets
- Will not remove polish or wax

Item	Size	Ship	Net
755489	22 oz.	2 lbs	\$9.99

### STAR BRITE SPIDER AWAY

- Shoo's spiders away without harming them
- Keeps messy spiders away from your boat
- Safe for use around pets and children
- Ideal for use around the house, garage and garden

Item	Size	Ship	Net
755488	22 oz.	2 lbs	\$9.99

### 3M MARINE BLACK STREAK REMOVER

- Designed to remove black streaks
- Safe for use on fiberglass, metal and painted surfaces

Item	Size	Ship	Net
755052	500 ml	2 lbs	\$13.99

### AMAZING ROLL-OFF

- For grease, rust and diesel stains
- Works on fiberglass, fabric, stainless steel, chrome, etc.
- Leaves a rust inhibiting, wax-like finish
- Excellent as a general purpose cleaner when diluted in water

Item	Size	Ship	Net
ⓐ 756666	32 oz.	3 lbs	\$8.99
ⓐ	Gallon	9 lbs	19.99

ⓐ Ships Ground Only No Extra Charge  
 ⓓ Larger Size Product; Ships at Dimensional Weight

🚚 Ships by Truck  
 ⚠️ Hazardous Material \$35.00 Fee; Ships Ground Only

**Defender**  
 Marine Outfitter Since 1938

The BRANDS you WANT and TRUST  
 in STOCK for LESS!  
[www.defender.com](http://www.defender.com)

## Wash & Wax

### 3M MARINE FIBERGLASS CLEANER & WAX

- Removes light to medium oxidation
- Cleans, polishes and protects fiberglass/gelcoat
- Combines cleaning compound with a blend of waxes
- Restores shine and protects in one application

Item	Size	Ship	Net
754967	1 Pint	2 lbs	\$16.99
754968	1 Quart	3 lbs	25.99
754969	Gallon	10 lbs	75.99



### 3M™ MARINE CLEAN & SHINE WAX

- Spray on/wipe off product that recaptures that just-waxed look and feel
- Excellent for use on wet or dry surfaces; no water needed
- Used to enhance the shine of gelcoat, marine topside paint and painted aluminum surfaces

Item	Size	Ship	Net
755051	16.9 oz. spray	2 lbs	\$14.99



### STAR BRITE PREMIUM CLEANER WAX WITH PTFE

- Cleans, restores and leaves a protective coating on fiberglass, metal and painted surfaces
- Ideal for restoring finishes that have faded
- For ultimate protection, apply Premium Marine Polish after wax

Item	Size	Ship	Net
756707	16 oz.	2 lbs	\$12.99
	32 oz.	3 lbs	18.99
	128 oz.	9 lbs	62.99



### STAR BRITE SEA SAFE WASH AND WAX

- Biodegradable/environmentally friendly
- Cleans, shines and protects in one step
- No hard rubbing or buffing required
- Concentrated for economical use
- Excellent for use on fiberglass, metal and painted surfaces

Item	Size	Ship	Net
755391	32 oz.	3 lbs	\$13.99



### WOODY WAX ULTRA PINE WASH-N-WAX BOAT SOAP

- Non-alkaline, non-wax stripping boat soap
- Leaves a wax finish behind which helps with water beading and cleaning time
- Kills mold spores
- Safe for all parts of your boat

Item	Size	Ship	Net
751611	34 oz.	3 lbs	\$16.99



### WOODY WAX ULTRA GLOSS FIBERGLASS RESTORING COMPOUND

- Contains waxes that penetrate your gelcoat
- Will not dry on the surface
- Use by hand or machine
- No need to apply additional wax coat

Item	Size	Ship	Net
751610	16 oz.	2 lbs	\$28.99



### Z-TUFF PRODUCTS Z-WASH & WAX

- One-step cleaner with wax (Won't strip wax)
- Mix 1 to 2 ounces per gallon of water
- Biodegradable and environmentally friendly

Item	Size	Ship	Net
756345	32 oz.	3 lbs	\$14.99
756346	Gallon	9 lbs	29.99



## Restorers, Compounds & Pad Cleaner

### 3M MARINE RESTORER AND WAX

- Removes heavy oxidation, rust and exhaust stains on fiberglass/gelcoat
- Combines a rubbing compound with special waxes which restore shine and protect in one application

Item	Size	Ship	Net
755238	32 oz.	3 lbs	\$28.99
751397	16 oz.	2 lbs	17.99



### 3M MARINE FINESSE-IT™ II GLAZE

- Removes minor scratches and light oxidation while producing a high-gloss finish on fiberglass and painted boats
- Contains no wax or silicone
- Recommended follow-up step after using 3M Marine Super Duty Rubbing Compound
- For best results, use by machine

Item	Size	Ship	Net
751391	Pint	2 lbs	\$25.99
750356	Quart	3 lbs	52.99
750357	Gallon	9 lbs	167.99



### 3M MARINE COLOR GLOSS RESTORER

- Compound/polish that combines a fast cutting compound with a finishing material
- Removes light to heavy oxidation, scratches, stains, blemishes and fine swirl marks from fiberglass gelcoats

Item	Size	Ship	Net
750355	16.9 oz.	2 lbs	\$26.99



### 3M MARINE RUBBING COMPOUND

- For heavy, aggressive compounding of oxidized gelcoat and marine paint
- Bufs to high gloss with minimal swirl marks
- Can be used by hand or machine
- Contains no wax or silicone

Item	Size	Ship	Net
751275	16.9 oz.	2 lbs	\$14.99



### 3M PERFECT-IT GELCOAT LIGHT CUTTING POLISH + WAX

- Super gloss polishing for fine scratches
- One-step finish with wax for light oxidation
- Leaves a durable wax finish
- Removes minor defects, light scratches, oxidation, chalk and water marks

Item	Type	Size	Ship	Net
756672	Light cutting	Pint	2 lbs	\$16.99
		Quart	3 lbs	28.99



### 3M PERFECT-IT GELCOAT MEDIUM CUTTING COMPOUND + WAX

- Combines medium cutting power with a glossy finish & durable wax
- Leaves a durable wax finish
- Removes heavy defects, scratches, oxidation, water marks and chalking

Item	Type	Size	Ship	Net
756671	Medium cutting	Pint	2 lbs	\$19.99
		Quart	3 lbs	35.99



### 3M PERFECT-IT GELCOAT HEAVY CUTTING COMPOUND

- Cuts through heavy oxidation, scratches, & other defects fast
- Stays wet longer = Use less, easier cleanup

Item	Type	Size	Ship	Net
756670	Heavy cutting	Pint	2 lbs	\$24.99
		Quart	3 lbs	47.99



### 3M MARINE COMPOUND AND FINISHING MATERIAL

- Designed to remove P600 or P800 dual action sand scratches from gelcoat
- Can be applied with a wool pad or an air or electric buffer (1500-2500 rpm) equipped with a 3M compounding buff pad

Item	Size	Ship	Net
754003	32 oz.	3 lbs	\$41.99



### STAR BRITE LIQUID RUBBING COMPOUND

- Easy to use on heavy oxidation
- Convenient liquid formula for medium to heavy oxidation
- Removes stains and scratches from fiberglass, metal and painted surfaces

Item	Size	Ship	Net
753804	Pint	2 lbs	\$10.99



### COLLINETE LIQUID FIBERGLASS BOAT CLEANER NO. 920

- Easily removes dirt, oxidation, oil, rust, grease and more from fiberglass finishes
- Restores original color without hard rubbing or buffing and leaves a clean surface to which Collinite waxes can bond perfectly

Item	Size	Ship	Net
751155	Pint	2 lbs	\$10.99
755947	1/2 Gallon	5 lbs	30.99



### MEGIUAR'S HEAVY DUTY OXIDATION REMOVER

- Removes moderate oxidation, scratches, stains and tough water spots on fiberglass gelcoat
- Restores color by effectively removing surface degradation
- Apply by hand or machine
- Wax and silicone free

Item	Size	Ship	Net
753506	16 oz.	2 lbs	\$11.99



### MEGIUAR'S NO. 91 PRO GRADE POWER CUT COMPOUND

- Removes scratches and heavy oxidation without scouring the finish
- Formulated for use on marine and RV fiberglass gelcoat surfaces
- Fast cutting, low-swirl compound
- VOC compliant

Item	Size	Ship	Net
755311	32 oz.	3 lbs	\$28.99



### POLI GLOW COMPLETE KIT

- Poli Glow is a proven concept in boat polish and "not" a wax
- Easily applied - wipes on without the need for rubbing or buffing
- Will not wash off with soap and water
- Makes old fiberglass shine like new - lasts over 12 months
- Includes 32 oz. Poli Glow, 32 oz. Poli Prep, applicator mitt and scrubby pad

Item	Description	Ship	Net
754072	Complete kit	6 lbs	\$64.99
754075	Polish only; 32 oz.	3 lbs	44.99



### POLI STRIP LIQUID

- Concentrated degreaser specifically formulated for easy removal of Poli Glow and other acrylic or polymer finishes
- When used as directed Poli Strip liquid will not harm vinyl graphics or stripping.

Item	Description	Ship	Net
756765	32 oz. bottle	3 lbs	\$19.99



### YACHT BRITE BUFF MAGIC

- Fiberglass reconditioner and deoxidizer
- Incredible metal polish and plexiglass/eisenglass scratch remover
- Machine or hand buff
- Excellent for glass and plastic, fiberglass exterior surfaces and stainless steel railings

Item	Size	Ship	Net
754960	22 oz.	2 lbs	\$24.99



### SHURHOLD SERIOUS PAD CLEANER - POWDERED CONCENTRATE

- Scientifically formulated for rejuvenating buffing pads
- Mixed with water, this cleaner dissolves compounds and waxes from wool, foam and blended buffing pads cleaning them to be used over and over
- Mix 1 scoop (scoop included) with 1 gallon of water
- This will allow for 10-12 batches
- Great for cleaning dock lines, microfiber and cotton bonnets

Item	Size	Ship	Net
756296	12 oz.	1 lbs	\$13.99



MADE IN USA



## Polishes & Waxes

### 3M™ MARINE ULTRA PERFORMANCE PASTE WAX

- Innovative product leaves a protective, high gloss finish on marine fiberglass gelcoat, topside paints, painted aluminum and metal parts
- Easy on-off formulation



Item	Size	Ship	Net
Ⓞ 751404	9.5 oz.	1 lbs	\$24.99

### 3M SCOTCHGARD™ MARINE LIQUID WAX

- Formulated for high gloss and durability
- Use on fiberglass/gelcoat, marine topside paints, painted aluminum and metal parts
- Superior protection from UV rays
- Bonds to your boat's surface



Item	Size	Ship	Net
Ⓞ 755292	16.9 oz.	2 lbs	\$16.99
Ⓞ 755293	33.8 oz.	3 lbs	29.99

### 3M PERFECT-IT BOAT WAX

- Use as the final step for any gelcoat, fiberglass, wood, or metal refinishing project where a wax finish is recommended and high-gloss results are desired



- Formulated with carnauba wax and is safe for gelcoat, paint, fiberglass and metal

Item	Size	Ship	Net
756918	16 oz.	2 lbs	\$15.99
	32 oz.	3 lbs	28.99

### WOODY WAX® CARNAUBA GLASS COAT

- Marine topside/hull wax for fiberglass or gelcoat surfaces
- Three quick coats provide (6) months of lasting shine and protection
- Easy, spray-on application



Item	Size	Ship	Net
755303	16 oz.	1 lbs	\$25.99

### WOODY WAX CARNAUBA CREME WAX

- Safe for all paints, clearcoats and fiberglass
- Covers light scratches and produces a deep shine
- Contains detergent resistant polymers for long-lasting protection



Item	Size	Ship	Net
755314	16 oz.	1 lbs	\$21.99

### WOODY WAX FIBERGLASS AND NON-SKID DECK WAX

- Places non-slick wax finish on decks - salt, dirt and fish blood will not stick
- Protects decks and fiberglass from the deteriorating effects of sun and oxidation



Item	Size	Ship	Net
Ⓞ 755304	16 oz.	2 lbs	\$32.99

### STAR BRITE® MARINE POLISH

- Ideal for new and old boats
- Helps stop fading caused by UV rays
- Long-lasting protection
- Quickly and easily removes oxidation
- For longest lasting shine, apply a finishing coat of Marine Polish with PTFE®



Item	Size	Ship	Net
751026	16 oz.	2 lbs	\$11.99

### STAR BRITE MARINE POLISH WITH PTFE

- For painted fiberglass and metal surfaces
- Reduces drag while it repels dirt
- PTFE polymers provide UV protection, repel stains and deliver a deep, long-lasting gloss finish
- For fresh or salt water



Item	Size	Ship	Net
755024	16 oz. liquid	2 lbs	\$15.99
755312	32 oz. liquid	3 lbs	26.99

### COLLINITE PASTE FLEETWAX NO. 885

- Seal and shield against acid rain, sun, salt spray, bugs and environmental acids
- Easily applied and non-abrasive wax will prevent finish deterioration and the adhesion of foreign elements



Item	Size	Ship	Net
Ⓞ 990057	12 oz.	2 lbs	\$19.99

### COLLINITE LIQUID FLEETWAX NO. 870

- Cleans, protects and beautifies in one easy step
- No hard rubbing or buffing
- Restores original color and luster to oxidized, soiled and stained fiberglass surfaces
- Leaves double coating of protection that lasts



Item	Size	Ship	Net
Ⓞ 750931	16 oz.	2 lbs	\$19.99
Ⓞ 755946	1/2 Gal.	5 lbs	49.99

### COLLINITE INSULATOR WAX NO. 845

- Versatile and durable last-step gel wax
- Provides high-gloss shine, long-lasting weather protection and is easy to use
- Excellent choice for fleet applications
- Extensive buffing not required
- Safe for gelcoat, fiberglass and clearcoat



Item	Size	Ship	Net
Ⓞ 755300	16 oz.	1 lbs	\$17.99

### COLLINITE FIBERGLASS BOAT WAX NO. 925

- Handcrafted last-step wax provides high-gloss shine, ease of use and long-lasting weather protection
- Pure carnauba wax formula
- Shrugs off scrubbing, scuffing, detergents, salt water and marine organisms



Item	Size	Ship	Net
Ⓞ 755302	16 oz.	1 lbs	\$17.99

### YACHT BRITE SERIOUS SHINE®

- One-step quick detailer cleans, polishes and protects virtually any solid surface
- Contains UV inhibitors and anti-static properties
- Provides high-gloss super slick, residue-free coating that repels water



Item	Size	Ship	Net
Ⓞ 754959	14 oz. aerosol	2 lbs	\$16.99

### YACHT BRITE PRO POLISH® WAX

- Polymer-based formula repels water and provides a deep high-gloss shine
- Protects finish against sun, salt and acid rain
- Excellent for clear eisenglass panels, glass and plastic, fiberglass decks and surfaces, hatches, stainless steel railings and fiberglass hulls



Item	Size	Ship	Net
754957	16 oz.	2 lbs	\$18.99

### MEGUIAR'S® HIGH GLOSS POLISH - BOATS/RV

- Restores brilliant gloss to fiberglass, painted marine and RV surfaces
- Provides valuable oils to nourish gelcoat
- Apply after surface has been thoroughly cleaned
- Especially effective on dark colors



Item	Size	Ship	Net
753504	16 oz.	2 lbs	\$11.99

### MEGUIAR'S PURE WAX - BOATS/RV

- Durable high-gloss protection for all fiberglass gelcoat marine and RV surfaces
- Blend of pure Brazilian carnauba wax, silicones, polymers and resins
- Protects against sun's damaging UV rays



Item	Size	Ship	Net
753514	16 oz.	2 lbs	\$13.99

### MEGUIAR'S PREMIUM MARINE WAX

- Enriches color and shine
- Long-lasting protection
- Removes light oxidation and dullness
- Protects gelcoat from UV damage



Item	Size	Ship	Net
753523	16 oz.	2 lbs	\$19.99

### MEGUIAR'S FLAGSHIP MARINE PASTE

- Incredibly deep gloss
- Glides on and off easily; cleans the surface while adding polishing oils
- Protects against UV damage
- Tough, long-lasting polymer protection



Item	Size	Ship	Net
Ⓞ 755309	11 oz.	1 lbs	\$22.99

### MEGUIAR'S ONE-STEP BOAT CLEANER/WAX

- Non-abrasive formula that cleans, polishes and protects in one step
- Removes light oxidation and haze, minor scratches and swirls
- Provides long-lasting protection against salt, corrosion and UV rays



Item	Size	Ship	Net
753509	16 oz.	2 lbs	\$14.99
756114	Gallon	10 lbs	49.99

## Deck Cleaners

### 3M MARINE NON-SKID DECK CLEANER

- Designed to clean hard-to-reach ground-in dirt and stains on non-skid decks
- Safe for use on fiberglass, metal and painted surfaces



Item	Size	Ship	Net
755053	33.8 oz.	3 lbs	\$21.99

### STAR BRITE SEA SAFE® DECK CLEANER

No Phosphates

- Biodegradable and environmentally friendly
- Cleans dirt and stains
- Leaves a durable, sealed, protective coating
- Use on fiberglass, metal, non-skid and painted surfaces



Item	Size	Ship	Net
755392	32 oz.	3 lbs	\$10.99

### STAR BRITE NON-SKID DECK CLEANER WITH PTFE

- Formulated to lift dirt from non-skid surfaces
- Biodegradable; leaves protective coating to resist staining and weathering
- Safe for use on fiberglass, vinyl, metal and paint
- Contains UV inhibitors to protect decks



Item	Size	Ship	Net
756716	22 oz.	2 lbs	\$8.99
	32 oz.	3 lbs	9.99
	1 Gal.	10 lbs	24.99

### Z-TUFF™ PRODUCTS Z-DECK CLEANER

- Non-skid deck cleaner with ZTP
- Special cleaning agents loosen dirt and stains without the need for heavy scrubbing
- ZTP polymers provide an advanced barrier against future stains and dirt
- Ideal for cleaning non-textured areas as well as fiberglass, vinyl, plastic, metal or rubber



Item	Size	Ship	Net
Ⓞ 756238	32 oz.	3 lbs	\$14.99

### MARYKATE® CLEANING DETAIL®

- Cleans and brightens fiberglass and metals
- Great for non-skid decks
- Removes dirt, grease, grime and chalking on fiberglass and aluminum boats



Item	Size	Ship	Net
751089	32 oz.	3 lbs	\$13.99

- Ⓞ Ships Ground Only No Extra Charge
- ⚠ Hazardous Material \$35.00 Fee; Ships Ground Only
- 🚚 Ships by Truck
- 📦 Larger Size Product; Ships at Dimensional Weight

## Bilge Cleaners

### ARMADA® BILGE CLEANER

- Made from a super-concentrated professional strength formula
  - Eliminates grease, oil, fuel, scum and sludge
  - Fresh scent, biodegradable and non-toxic
- | Item     | Size   | Ship  | Net     |
|----------|--------|-------|---------|
| Ⓞ 753422 | Gallon | 9 lbs | \$14.99 |



### MARYKATE® BIG BULLY® BILGE CLEANER

- Leaves bilge clean and fresh
  - Emulsifies oil, grease and scum
  - Self-cleaning commercial formula
  - Let the boat's rolling action clean out the bilge
- | Item     | Size   | Ship  | Net     |
|----------|--------|-------|---------|
| Ⓞ 751120 | Quart  | 3 lbs | \$12.99 |
| Ⓞ 751121 | Gallon | 9 lbs | 32.99   |



No Phosphates

### STAR BRITE SEA SAFE® BILGE CLEANER

- Biodegradable and environmentally friendly
  - Dissolves oil, grease, fuel and sludge
  - Leaves bilge clean and fresh
  - Easy to use - just pour in bilge, run boat and pump out
- | Item   | Size   | Ship  | Net     |
|--------|--------|-------|---------|
| 755390 | 32 oz. | 3 lbs | \$11.99 |



### STAR BRITE SUPER ORANGE CITRUS BILGE CLEANER

- Citrus extract formula
  - Emulsifies oil, grease, fuel and transmission fluid
  - Pour in, run boat, drain
  - Biodegradable
  - Will not harm fiberglass, metal or plastic
- | Item   | Size   | Ship  | Net    |
|--------|--------|-------|--------|
| 755322 | 32 oz. | 3 lbs | \$8.99 |



### STAR BRITE HEAVY DUTY BILGE CLEANER

- Biodegradable formula
  - Dissolves oil, sludge and fuel
  - Leaves bilge fresh and clean
  - Easy to use - pour in bilge (Add water), run boat for one hour and drain
  - Eliminates mildew stains on contact
- | Item   | Size   | Ship   | Net    |
|--------|--------|--------|--------|
| 751122 | Quart  | 3 lbs  | \$9.99 |
| 751123 | Gallon | 10 lbs | 24.99  |



❖ For more detailed product specifications and our complete selection visit [www.defender.com](http://www.defender.com) or call 800-628-8225 ❖

## Metal Care

### STAR BRITE® TOWER GUARD MARINE METAL CLEANER/PROTECTOR

- Special polymers provide protective barrier against salt, corrosion, UV rays and dirt
  - Use on aluminum, stainless steel, chrome, brass, anodized and other metals
  - Spray-on and wipe-off
- | Item   | Size   | Ship  | Net     |
|--------|--------|-------|---------|
| 755633 | 22 oz. | 2 lbs | \$11.99 |



### NEVR-DULL® METAL POLISH

- Non-scratching, non-corrosive polish and cleaner on cotton wadding cloth
  - Safe for all metals
  - Leaves no residue
  - Instantly removes tarnish and dirt
- | Item     | Size  | Ship  | Net    |
|----------|-------|-------|--------|
| Ⓞ 753609 | 5 oz. | 1 lbs | \$6.99 |



### CRC® RUST CONVERTER

- Neutralizes and converts rust to a tough Black primer in one easy step
  - No more scraping - simply remove loose rust and apply product
  - Second coat can be applied within 20 - 30 min.
  - Treated surfaces may be used as a finish coat or painted over
- | Item   | Size   | Ship  | Net     |
|--------|--------|-------|---------|
| 755555 | 32 oz. | 3 lbs | \$19.99 |



### 3M™ MARINE ALUMINUM RESTORER AND POLISH

- Restores lustrous appearance to bare aluminum
  - Removes oxidation, surface rust, chalking and stains
  - Concentrated formula
- | Item     | Size   | Ship  | Net     |
|----------|--------|-------|---------|
| Ⓞ 755239 | 18 oz. | 2 lbs | \$25.99 |



### 3M MARINE METAL RESTORER & POLISH

- Removes rust, oxidation, corrosion and tarnish
  - Recommended for stainless steel, chrome, brass, bronze and other marine metals
  - Restores original luster
- | Item   | Size   | Ship  | Net     |
|--------|--------|-------|---------|
| 752265 | 18 oz. | 2 lbs | \$24.99 |



### FLITZ POLISH

- Designed for metal, glass, plastic and fiberglass
- Non-abrasive; cleans, polishes, deoxidizes and protects
- Protects up to 6 months in fresh water; up to 3 months in salt water



#### Paste

Item	Size	Ship	M.A.P.
756864	1.76 oz.	1 lbs	\$9.19
	5.29 oz. tube	1 lbs	20.06
	1 lb can	2 lbs	29.96

#### Liquid

Item	Size	Ship	M.A.P.
755752	7.6 oz.	1 lbs	\$13.37

### COLLINITE LIQUID METAL WAX

- Cleans and protects chrome, aluminum, copper, brass and stainless steel
  - Safely removes rust and salt deposits
  - Protects marine fittings and accessories
- | Item     | Size   | Ship  | Net     |
|----------|--------|-------|---------|
| Ⓞ 990056 | 16 oz. | 2 lbs | \$13.99 |



**M.A.P.** Some manufacturers set M.A.P. (Minimum Advertising Pricing) for their products, so we cannot advertise a lower price. However, this does not always apply to selling price. The actual price you will be charged is probably lower. Please call us at 800-628-8225 for further details.

## Lubrication & Corrosion Protection

### FORESPAR® MARELUBE™

- Waterproof, synthetics formulated for use in harsh marine conditions
  - Keeps moving parts moving under load
  - Works equally well in fresh or salt water
  - Non-conductive, PTFE-based formula
  - An excellent corrosion and rust inhibitor
  - Ships 1 lbs
- | Item     | Size   | Description | Net     |
|----------|--------|-------------|---------|
| Ⓞ 501420 | 4 oz.  | Gel         | \$13.99 |
| Ⓞ 503276 | 16 oz. | Liquid      | 18.99   |



### FORESPAR MARELUBE TEF 45™

- Excellent for dissimilar metals barrier and long term protection
  - Superior corrosion barrier and anti-seize for screws, bolts and nuts
- | Item   | Size          | Ship  | Net     |
|--------|---------------|-------|---------|
| 503645 | 6 cc syringe  | 1 lbs | \$11.99 |
|        | 30 cc syringe | 1 lbs | 14.99   |
|        | 4 oz. tub     | 1 lbs | 30.99   |
|        | 16 oz. tub    | 1 lbs | 102.99  |



### FORESPAR LANOCOTE®

- Formulated to withstand salt water
  - Prevents thread seizure due to all types of corrosion on boats and machinery
- | Item     | Size        | Ship  | Net     |
|----------|-------------|-------|---------|
| Ⓞ 608711 | 4 oz. Jar   | 1 lbs | \$10.99 |
|          | 8 oz. Spray | 1 lbs | 12.99   |
|          | 16 oz. Jar  | 1 lbs | 26.99   |



### FORESPAR MARELUBE REACH MARINE VALVE LUBRICATION KIT

- For hard to reach valve locations
  - Keeps valve seals lubricated for longer life
  - Contents: 30cc preloaded syringe, extension tube, nozzle, applicator brush
- | Item     | Model  | Ship  | Net     |
|----------|--------|-------|---------|
| Ⓞ 503391 | 770049 | 1 lbs | \$12.99 |



### STAR BRITE WHITE LITHIUM SPRAY LUBE

- Formulated for general marine lubrication
  - Water and heat resistant
  - Extension tube included to treat hard-to-reach places
  - Use wherever heavy duty lithium grease is required
- | Item     | Size   | Ship  | Net    |
|----------|--------|-------|--------|
| Ⓞ 754062 | 12 oz. | 2 lbs | \$7.99 |



### WOODY WAX® KIT

- Restores and protects anodized aluminum, stainless, chrome and more
  - Prevents water spots, corrosion, oxidation for up to 6 months
  - Kit contains: 16 oz. wax, 8 oz. sealer, bronze wool and applicator brush
- | Item     | Ship  | Net     |
|----------|-------|---------|
| Ⓞ 751632 | 2 lbs | \$44.99 |



### BOESHIELD® T-9® LUBRICANT & PROTECTANT

- Long-lasting corrosion protection for all metals with just one application
  - Superior lubrication and penetration
- | Item     | Size           | Ship  | Net     |
|----------|----------------|-------|---------|
| Ⓞ 752245 | 12 oz. aerosol | 1 lbs | \$15.99 |



### CRC HEAVY DUTY SILICONE™

- Multi-purpose, water-resistant spray lubricant
  - Forms a colorless, odorless, non-staining film that lubricates and protects
  - Dry film eliminates binding and sticking
- | Item     | Size  | Ship  | Net    |
|----------|-------|-------|--------|
| Ⓞ 754943 | 9 oz. | 1 lbs | \$4.99 |



### CRC 6-56® MULTI-PURPOSE LUBRICANT - ZERO VOC

- Odor-free, multi-purpose lubricant
  - Frees rusted parts; lubricates and protects against corrosion
  - Great for fishing reels, winches, pulleys, metals
  - Drives out moisture; starts wet engines
- | Item     | Size   | Ship  | Net    |
|----------|--------|-------|--------|
| Ⓞ 755554 | 11 oz. | 1 lbs | \$6.99 |



### H & M MARINE CORROSION BLOCK®

- Helps to isolate moisture from metal surface and stops corrosion process
  - Penetrates and loosens seized parts
  - Protects electronics from moisture
  - Highly effective as a lubricant
- | Item     | Size           | Ship  | Net   |
|----------|----------------|-------|-------|
| Ⓞ 752248 | 12 oz. Aerosol | 1 lbs | 18.99 |





## Plastic & Strataglass Cleaner

### IMAR™ STRATAGLASS™ PROTECTIVE CLEANER

- Safely and effectively cleans, shines and protects Strataglass and other clear vinyl
- UV protection enhances flexibility; anti-static formula helps repel surface dirt

Item	Size	Ship	Net
Ⓞ 755220	16 oz.	2 lbs	\$18.99

### IMAR STRATAGLASS PROTECTIVE POLISH

- Safely and effectively cleans, polishes and protects Strataglass and other clear vinyl
- UV-resistant sunscreen formula offers exceptional durability
- Easy to apply; use before Protective Cleaner #301

Item	Size	Ship	Net
Ⓞ 755221	16 oz.	2 lbs	\$19.99

### STAR BRITE® ULTIMATE XTREME CLEAN

- Removes toughest dirt and greasy stains, even on porous surfaces
- Use on fiberglass, vinyl, plastic, metal and even inflatable boats

Item	Size	Ship	Net
756757	32 oz.	3 lbs	\$10.99

### STAR BRITE VIEW GUARD CLEAR PLASTIC TREATMENT

- Gently cleans clear plastic surfaces
- For use on clear plastic enclosures such as Strataglass®, EZ2CY®, Eisinglass, etc.
- Wet weather visibility enhancer
- Repels water, spray, salt and dirt
- Provides a barrier to damaging UV rays

Item	Size	Ship	Net
755670	22 oz.	2 lbs	\$10.99



### MEGUIAR'S® MIRROR GLAZE® CLEAR PLASTIC CLEANER & MIRROR GLAZE CLEAR PLASTIC POLISH

- Cleaner removes hairline scratches from clear plastic
- Unique non-abrasive formula
- Prepares surface for Clear Plastic Polish
- Polish restores optic clarity and provides static-free coating that repels dust
- Safe and effective on acrylic and polycarbonate surfaces; VOC compliant

Item	Size	Ship	Net
753498	Step 1, 8 oz.	1 lbs	\$8.99
753497	Step 2, 8 oz.	1 lbs	8.99

### MEGUIAR'S MIRROR GLAZE CLEAR PLASTIC DETAILER®

- A single-step solution that keeps clear plastic surfaces pristine
- Non-abrasive formula removes smudges and residue from clear plastics
- Restores and maintains optic clarity
- Provides an anti-static, non-hazing surface
- Safely remove surface contamination and achieve dramatic results on everything from window panels and instrument lenses to eyeglasses, cds and picture frames

Item	Size	Ship	Net
753500	8 oz.	1 lbs	\$8.99



LIKE US ON FACEBOOK  
FACEBOOK.COM/DEFENDERINDUSTRIES

### ARMADA 210® PLASTIC CLEANER/POLISH

- The professional's choice for protecting and maintaining eisinglass, plexiglass and vinyl
- Provides all plastics with a clear, lustrous look
- Anti-static, anti-fog and non-streaking

Item	Size	Ship	Net
Ⓞ 754153	14 oz.	2 lbs	\$15.99

### ARMADA 210 PLUS PLASTIC SCRATCH REMOVER

- Remove surface scratches and blemishing
- Extremely mild abrasive
- One-step, water-soluble formula is easy to use
- Produces superior results
- Anti-fog and anti-static properties

Item	Size	Ship	Net
Ⓞ 754193	15 oz.	2 lbs	\$17.99



## Hoses and Nozzles



### ZERO-G MARINE AND RV WATER HOSE

- Drinking water safe, lead free, burst rated: 600+ PSI
- Garden hose connections, (1) Male / (1) Female
- 40% lighter than vinyl hoses,
- Flexible down to 35° F

Item	Model	Length	Ship	Net
756769	4006-25	25'	3 lbs	\$19.99
	4006-50	50'	4 lbs	29.99

### NEVERKINK MARINE HOSE

- MicroShield® antimicrobial built in
- Drinking water safe
- Grip-Tite® coupling for an easy, leak free connection at the faucet



Item	Size	Ship	Net
756804	25' x 5/8" dia.	4 lbs	\$15.99
	50' x 5/8" dia.	8 lbs	25.99
	75' x 5/8" dia.	12 lbs	34.99

### HOSECOIL THUMB LEVER NOZZLE

- Adjustable spray pattern nozzle and On/Off thumb flow control
- Soft contoured rubber grip

Item	Model	Ship	Net
259837	WN810U	1 lbs	\$9.49



### CAMCO TASTEURE MARINE AND RV WATER HOSE

- Super heavy duty and reinforced for maximum kink resistance
- Especially useful when hooked with a Y-valve to main faucet



Item	Size	Ship	Net
756805	25' Long x 5/8"	3 lbs	\$14.99
	50' Long x 5/8"	6 lbs	25.99
	75' Long x 5/8"	10 lbs	35.99

### Camco Brass 90° Hose Fitting- threads: 1-1/16"

755910	(1) Male/(1) Female GHT	1 lbs	6.99
--------	-------------------------	-------	------

### CAMCO HOSE HANGER

- Attaches in-line, between your water hose and spray nozzle, and easily hooks to your boat's rail to keep your hose handy
- Fits up to 1" round rail
- Includes rubber gasket



Item	Model	Ship	Net
756327	20191	1 lbs	\$2.79

## Vinyl, Fabric & Leather Care

### 3M™ MARINE VINYL CLEANER & RESTORER

- Cleans, shines, conditions and protects vinyl, rubber and plastic
- Deep cleans dirt and grime
- Restores natural sheen and enhances appearance

Item	Size	Ship	Net
751393	16.9 oz.	2 lbs	\$13.99

### 3M MARINE VINYL CONDITIONER & PROTECTOR

- Designed to clean, condition and protect marine vinyl and rubber components
- Gel formula gives you better application control than liquids

Item	Size	Ship	Net
753785	8 oz.	1 lbs	\$15.99

### STAR BRITE VINYL CLEANER & POLISH

- Makes old, dull vinyl look new
- Removes stains and yellowing
- Prevent vinyl surfaces from drying out and cracking, keeping them soft and supple

Item	Size	Ship	Net
755016	16 oz.	2 lbs	\$10.99

### STAR BRITE WATERPROOFING AND FABRIC TREATMENT WITH PTFE®

- Restores water repellency; extends service life
- Effective waterproofing solution for boat covers, bimini tops, sail covers, tents and more
- Does not change color or feel of fabric

Item	Size	Ship	Net
Ⓞ 755005	22 oz.	2 lbs	\$15.99
Ⓞ 750887	Gallon	8 lbs	37.99

### STAR BRITE SAIL AND CANVAS CLEANER

- Concentrated formula removes dirt, grease and mildew from sails and canvas items
- Cleans and brightens all types of fabrics
- Biodegradable, safe and easy to use

Item	Size	Ship	Net
Ⓞ 751045	16 oz.	2 lbs	\$8.49



### 303® MULTI-SURFACE CLEANER

- Ultimate cleaning power
- No greasy residue
- Safely brightens and rejuvenates surfaces
- Leaves surfaces looking new every time

Item	Size	Ship	Net
Ⓞ 756353	32 oz.	3 lbs	\$11.99



### 303 MARINE & RECREATION FABRIC GUARD

- Restores lost water and stain repellency
- Keeps fabric dry to help prevent molding
- Provides strong resistance against soiling
- Protects against water and oil-based stains
- Does not alter fabric color or characteristics
- Safe for synthetic or natural fibers

Item	Size	Ship	Net
Ⓞ 756351	16 oz.	1 lbs	\$12.99
Ⓞ 756352	32 oz.	2 lbs	23.99



### COLLINTE LEATHER AND VINYL WAX

- Conditioner and protectant
- Gently cleans, moisturizes and protects a variety of leather and vinyl surfaces
- Helps prevent fading, drying, cracking, staining and premature aging

Item	Size	Ship	Net
Ⓞ 755945	Pint	2 lbs	\$13.99



### Z-TUFF PRODUCTS™ Z-PROTECTANT UV CARE

- Ready to use, spray-on, multi-surface protector and conditioner
- Reduces fading of vinyl, rubber, plastic, fiberglass, zipper teeth and more
- Non-greasy formula
- Restores natural color and shine
- 100% biodegradable
- Environmentally safe and friendly
- Non-flammable

Item	Size	Ship	Net
Ⓞ 756636	32 oz.	3 lbs	\$15.99



## Cleaning Tools and Kits



### SHURHOLD BOAT CLEANING TOOLS

Item	Description	Ship	Net
756807	40" Fixed length handle	1 lbs	\$14.99
	60" Fixed length handle	1 lbs	19.99
754882	30" Fixed length handle with finger grip	1 lbs	10.99
756808	6' Telescoping extension handle (43" - 72")	2 lbs	29.99
	9' Telescoping extension handle (63" - 108")	2 lbs	38.99
754910	10" 30° Curved adapter	1 lbs	12.99
754903	3-in-1 Boat hook attachment	1 lbs	12.99
756809	6" Deck brush, soft and medium bristles	2 lbs	29.99
	6" Deck brush, stiff bristles	2 lbs	24.99
	6" Deck brush, medium bristles	2 lbs	24.99
	6" Deck brush, soft bristles	2 lbs	26.99
	6" Deck brush, extra soft bristles	2 lbs	29.99
756817	8" Window and hull brush soft	2 lbs	26.99
	8" Window and hull brush, extra soft bristles	2 lbs	29.99
756816	10" Deck brush, soft bristles	2 lbs	36.99
	10" Deck brush, medium bristles	2 lbs	36.99
	10" Deck brush, stiff bristles	2 lbs	36.99
754901	Synthetic chamois mop	1 lbs	33.99
754899	Swivel pad and synthetic lamb's wool cover	1 lbs	30.99
752301	12" long Shur-dry flexible water blade	1 lbs	24.99
754905	Nylon landing net (17" x 20" x 30")	1 lbs	36.99
754909	Threaded adapter	1 lbs	7.99
754918	Hose nozzle, die-cast zinc with Black vinyl grip	1 lbs	9.99
754991	Deluxe lamb's wool wash mitt	1 lbs	19.99
756329	Camera mount adapter for Shurhold handles	1 lbs	11.49
752300	Hammerhead brush for Shurhold handles	2 lbs	24.99

### Shurhold Basic Marine Cleaning Kit

Item	Description	Ship	Net
754922	6' Telescoping handle, 3-in-1 boat hook, cotton string mop, 6" soft deck brush, snap-stick .45 oz. tube	6 lbs	\$79.99



### STAR BRITE TELESCOPING DECK BRUSH

- Extends from 3' to 6' • (2) Non-slip hand grips and positive twist lock
- Aircraft grade, triple-anodized aluminum
- Medium duty 8" deluxe deck brush with bumper has high density Star "prene" fibers for all-purpose deck cleaning

Item	Description	Ship	Net
755522	Telescoping deck brush (Handle with brush)	3 lbs	\$34.99

- Synthetic wood head: 8" wide, brush only - (Handle sold separately)
- Designed to fit all extend-a-brush premium handles

Item	Model	Color	Type	Ship	Net
756705	40170	Yellow	Soft	2 lbs	\$29.99
	40171	Blue	Medium	2 lbs	29.99
	40172	White	Stiff/Coarse	2 lbs	29.99

### STAR BRITE PREMIUM HEAVY DUTY EXTENDING HANDLE WITH SYNTHETIC BRUSH

- Extends from 3 to 6 feet; lightweight and incredibly strong
- Includes (2) Non-slip hand grips, positive twist lock and brush head
- Handle material: Triple anodized aluminum, Brush material: Synthetic wood

Item	Model	Description	Ship	Net
756706	40177	Extending brush with medium duty bristles	3 lbs	\$54.99

### STAR BRITE EXTEND-A-BRUSH

Item	Description	Ship	Net
754088	Telescoping Aluminum pole from 2' - 4' • Polypropylene brush head Handle, 8" brush with Star "prene" bristles	2 lbs	\$30.99

### Accessories & Attachments

Item	Description	Ship	Net
755514	Deluxe scrubber pad - attaches to telescoping Deck brush with use of adjustable knuckle (below) Specify: Fine, medium or coarse	1 lbs	\$6.59
755521	Deluxe 8" Block brush with bumper Specify: Soft, medium or coarse	2 lbs	16.99
754258	Heavy duty extending handle (extends 3-6')	1 lbs	28.99
755516	Chamois mop head	1 lbs	17.99
756139	Microfiber reggae drying pad	1 lbs	17.99
756137	Boat blade squeegee	1 lbs	21.99
755518	Screw thread adapter	1 lbs	5.99
755515	Adjustable knuckle	1 lbs	5.49

### SURFSTOW SUPGRIP QUIKGRIP

- Instantly installs - no tools required
- Locking super-grip suction

Item	Model	Ship	Net
401969	50080-3	3 lbs	\$13.99

Item	Description	Ship	Net
755494	STAR BRITE DETAIL BRUSH Ship 1 lbs Specify: Nylon, brass or stainless steel bristles Plastic handle; 1/2" bristle; 1-1/2" x 7/16" block		\$2.99

Item	Description/Size	Ship	Net
755490	STAR BRITE CELLULOSE SPONGES Ship 1 lbs Rectangle: 7-3/4" x 4-1/4" x 2-3/4"		\$8.99
755491	Rectangle: 9" x 4-1/2" x 1-3/4"		7.49
755492	Half moon: 7-3/4" x 3-1/2" x 2-1/2"		5.99

Item	Description	Ship	Net
755528	STAR BRITE MICROFIBER REGGAE SPONGE Blue, (2) Sided, absorbent material and nylon mesh scrubber	1 lbs	\$7.49

Item	Description	Ship	Net
754119	Z-TUFF PRODUCTS Z-SCRUBBER CLEANING PAD Sponge sandwiched between (2) melamine-cleaning pads	1 lbs	\$2.79

## Handle Accessories

Item	Model	Handle Type	Ship	Net
756749	SHD 760H	5' Fixed	1 lbs	\$15.99
	SHD 833H	6' Telescoping	1 lbs	17.99
	SHD 855H	9' Telescoping	1 lbs	20.99

## Brooms, Brushes, Bags & Buckets

Item	Description	Ship	Net
756940	NEW! DEFENDER ONE BUCKET SYSTEM • 5-gallon UV resistant bucket • Includes caddy, grate and padded lid/seat • Handle: Blue rope • Bucket Color: White • Transports, holds, washes and organizes	5 lbs	\$48.99

Item	Description	Ship	Net
754914	SHURHOLD LONG & SHORT DIP & SCRUB BRUSH Stiff chemical resistant bristles. Makes it faster and easier to clean bait wells, wheels, waterlines and hard to reach places. Extra-long 20" handle	1 lbs	\$8.99
754913	Compact handle	1 lbs	7.99

Item	Description	Ship	Net
754911	SHURHOLD UTILITY BRUSH Perfect for upholstery, floor mats, vinyl, canvas and more. Spot scrubber on handle	1 lbs	\$5.49

Item	Description	Ship	Net
754912	SHURHOLD SCRUB BRUSH Soft, lightweight comfort handle and safety bumper. Color: Blue Knuckle saving handle	1 lbs	\$8.99

Item	Size	Ship	Net
449998	STORMATE® COLLAPSIBLE BROOM 3-section aluminum shaft with twist locks and integrated dust pan Telescopes From 27"-50"	2 lbs	\$20.99

Item	Capacity	Size	Ship	Net
754134	CAMCO COLLAPSIBLE BUCKET Metal handle folds down • Carrying case 3 Gal	9.25" H; folds to 2"	2 lbs	\$12.49
402271	Camco Mini Pop-Up Container 9.5" x 13"		1 lbs	6.99

Item	Size	Ship	Net
756806	GREEN MOUNTAIN HEAVY DUTY CANVAS BUCKET • Holds water, tools, equipment, etc • Heavy duty natural canvas • Includes 2" plastic snap buckle • Suitable for boson's chair • 20" long strap 1.5 Gallon	1 lbs	\$11.99
	3 Gallons	1 lbs	14.99



## Sanding & Polishing



### A. SHURHOLD ELECTRIC DUAL ACTION PROFESSIONAL GRADE POLISHER PRO

- 6" Quick change backing plate
- 1800-4800 RPM
- (2) Different ergonomic gripping styles
- Includes canvas storage bag

Item	Model	Description	Ship	M.A.P.
756641	3500	(Pads sold separately)	9 lbs	\$248.99

Item	Model	Description	Ship	Net
756642	7"	Polisher foam pad for Model 3500 only	1 lbs	\$17.99

Specify: Extra fine, fine or medium/coarse

### B. SHURHOLD DUAL ACTION POLISHER

The dual action, oscillating head prevents burn and swirl marks.

Includes: Canvas bag, 20' power cord with GFCI protect plug (pads sold separately)

Item	Model	Description	Ship	M.A.P.
752554	3100	Dual Action polisher	9 lbs	\$144.98



### C. SHURHOLD BUFF/SCRUBBER/POLISH PADS & BRUSHES

for Dual Action Polisher model 3100 only

Item	Model	Description	Ship	Net
752556	3151	Buff Magic compounding pad; 100% twisted wool light cutting pad; 2 pack	1 lbs	\$19.99
752558	3152	Pro Polish pad; Black foam, polish and wax; 2 pack	1 lbs	19.99
756295	3210	Magic Bronze wool polisher pads; 2 pack	1 lbs	17.99
756293	5"	Scrubber pad; Specify: Fine, medium or coarse	1 lbs	6.99
756294	6-1/2"	Scrubber brush; Specify: Soft, medium or stiff	1 lbs	18.99



### D. SHURHOLD BRITE BONNET FINAL POLISH PAD

- Removes excess wax
- Buffs surfaces

Item	Model	Description	Ship	Net
756192	3153	Microfiber pad attaches to backing plate	1 lbs	\$10.99

### E. SHURHOLD SERIOUS PAD CLEANER - 12 OZ. POWDER CONCENTRATE

- Dissolves compounds and waxes from wool, foam and blended buffing pads

Item	Model	Description	Ship	Net
756296	30803	Formulated cleaner for rejuvenating buffing pads	1 lbs	\$13.99

### F. 3M IMPERIAL WETORDRY™ SANDPAPER - 9" X 11", 5 SHEETS PER PACK

Item	Model	Description	Ship	Net
754092		Silicon Carbide Specify grade: Ultra fine 600, Extra fine 320, Very fine 220 or assorted	1 lbs	\$4.89

Item	Model	Description	Ship	Net
754090		Aluminum Oxide Specify grade: P800, P600, P400, P320 or P220	1 lbs	\$6.49

### G. MEGUIAR'S FOAM APPLICATOR PADS

Fiber-free, foam pad produces a swirl-free, high gloss finish.

Item	Model	Description	Ship	Net
753519	W0004	4.5" Foam applicator pads; 4 pack	1 lbs	\$5.99

## Respirators & Protective Clothing

### 3M™ PARTICULATE RESPIRATOR

Meets NIOSH requirements. Patented filter media with advanced electrostatically charged microfibers make breathing easier and cooler. Lightweight construction enhances comfort and wear time. Adjustable noseclip reduces eyewear fogging and ensures a better seal. Two-strap design with welded dual point attachment.

Item	Model	Package	Ship	Net
754932	051138-46457	20 pack	1 lbs	\$19.99



### 3M DUAL CARTRIDGE ORGANIC VAPOR RESPIRATOR 5000 SERIES

NIOSH approved disposable respirator offers a new level of comfort and protection for painting. Available in three convenient sizes. Packaged with one pair of 3M particulate filters 5P71, P95 and one pair of 3M retainers 501.

Item	Specify	Size	Ship	Net
756580		Small, Medium or Large	1 lbs	\$24.99



Disposable!

### 3M HALF FACEPIECE VAPOR RESPIRATOR 6000 SERIES

Meets NIOSH requirements for organic vapors. 95% efficient in removing solid and liquid particles. Suggested for spray paint, enamel and pesticides. Changeable filters and cartridges.

Item	Size	Ship	Net
756579	Medium or large	1 lbs	\$39.99
754939	(2 pack) Filter for 6000, 7000, and FF-400 series	1 lbs	10.49



Reusable!

### WESTERN PACIFIC TRADING ANTI-FOG SAFETY GOGGLES

ANSI approved chemical splash protection. Heavy duty face plate. Pliable sides with strong, elastic head band.

Item	Model	Ship	Net
756711	52015	1 lbs	\$4.99



### CLEAR POLYETHYLENE DISPOSABLE GLOVES

- Provides protection from paints, stains and resins
- Fingertip sensitivity
- One size fits most

Item	Description	Ship	Net
754213	24 gloves per package	1 lbs	\$6.99

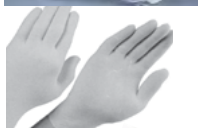

### WESTERN PACIFIC TRADING DISPOSABLE GLOVES

- Size: Large; inside coating: light powder
- Gloves fit either hand
- Sold (10) gloves per package

Item	Model	Material	Ship	Net
756712	61007	Nitrile	1 lbs	\$1.59
756713	61009	Latex	1 lbs	1.59



Nitrile Latex

### HEAVY DUTY PROTECTIVE BOOT COVERS- 2 PAIR

- Secure elastic top with wide opening
- Features Tuff Sole
- One size fits most

Item	Description	Ship	Net
755498	One size fits most	1 lbs	\$2.89



### SUPERPOLYMER DISPOSABLE COVERALLS

- Provides protection ordinary coveralls can't match
- Excellent for messy jobs, especially those with airborne dirt and dust, as well as sprayed and splattered liquids
- Elastic on wrists and ankles; hood with elastic face opening and full zipper

Item	Model	Size	Ship	Net
751677	1428	XL only	1 lbs	\$8.99



### COTTONIQUE SPRAY HOOD

- For spray protection and comfort
- Water repellent
- Oversized for extra breathing room
- Reusable
- Highly porous, allowing perspiration to evaporate but no dust or overspray to get in

Item	Model	Package	Ship	Net
751678	900	2 per pack	1 lbs	\$2.99



### DUST MASKS

- Includes metal nose clip
- Sold (5) masks per package
- Dust protection only - not designed for vapor protection

Item	Model	Ship	Net
756272	DM-5P	1 lbs	\$1.00



## Rags & Towels

### SHURHOLD PVA TOWEL

- High tech synthetic material
- Lint free and resists mold and mildew
- Absorbs 50% more than chamois
- 17" x 27"

Item	Ship	Net
754920	1 lbs	\$14.99



### BAG OF RAGS - ONE POUND

Premium reclaimed White t-shirt cloth rags. Practically lint-free.

Item	Ship	Net
753657	1 lbs	\$4.49



### BUFFALO INDUSTRIES MICROFIBER CLEANING TOWELS

Ultra-absorbent and gentle. Washable and reusable.

Item	Size	Ship	Net
756330	(12) pieces 12" x 16"	1 lbs	\$12.99
756331	(2) pieces 20" x 20"	1 lbs	7.99



### 6 PACK TERRY TOWELS

Great for polishing, dusting and waxing. 100% Cotton terry towels.

Item	Size	Ship	Net
754699	(6) pieces 14" x 17"	1 lbs	\$4.99



**PETTIT HRT**

Way MORE Technology...



Way LESS Expensive...

**NEW! Hybrid Reactive Technology**



**HRT NEPTUNE**

- Economical hybrid protection • Smooth durable polishing finish
- Apply over most antifouling paints • Simple soap and water clean up

**Specify Color:** • Black • Blue • Green • Red

Item	Size	Ship	Net	Item	Size	Ship	Net
Ⓞ 756935	Gal.	15 lbs	\$109.99	Ⓞ	Qt.	15 lbs	\$38.99



**HRT UNEPOXY**

- Strong enough to handle the tough marine environment without building up over time • Economical hybrid protection • Smooth durable polishing finish • Compatible over most bottom paints

**Specify Color:** • Blue • Red • Black • Green\*

Item	Size	Ship	Net	Item	Size	Ship	Net
Ⓞ 756934	Gal.	15 lbs	\$104.99	Ⓞ	Qt.	5 lbs	\$34.99

\*Quarts in Black and Blue only



**HRT ECO**

- Copper-free antifouling using the latest technology to create a hybrid paint film strong enough to handle the tough marine environment without building up over time

**Specify Color:** • Blue • Black • Gray

Item	Size	Ship	Net
Ⓞ 756936	Gal.	16 lbs	\$136.99



**HRT PREMIUM**

- Hybrid Reactive Technology features high density biocide utilization to maximize effectiveness by using biocide more effectively along with film modifiers to reduce yearly build-up, maintain uniform color consistency, and lower weight while providing a smoother finish than traditional paints.

Item	Size	Ship	Net
Ⓞ 756933	Gal.	19 lbs	\$129.99

**Water-Based Ablative**



**HYDROCOAT® ECO ANTIPOULING PAINT**

- Easy application and cleanup with soap and water
- Water-based, copper-free, self-polishing ablative, antifouling paint
- Co-polymer ablative technology eliminates sanding and paint buildup
- Dual-biocides provide outstanding multi-season protection in all conditions
- Uses the power of organic ECONEA™ for better protection and a greener earth

**Specify Color:** • Blue • Green • Red • Black • White

Item	Size	Ship	Net	Item	Size	Ship	Net
Ⓞ 756244	Gal.	14 lbs	\$239.99	Ⓞ 756245*	Qt.	4 lbs	\$88.99

\*Quarts in Black and Blue only



**HYDROCOAT® SR WITH IRGAROL**

- Dual biocides provide multi-season protection • Ablative surface eliminates sanding and paint build-up • Allows unlimited dry time to launch • Easy cleanup with soap and water

**Specify Color:** • Blue • Black • Red

Item	Size	Ship	Net
Ⓞ 755776	Quart	5 lbs	\$81.99
Ⓞ 755777	Gallon	18 lbs	\$221.99



**HYDROCOAT**

- Best water-based, multi-season ablative antifouling coating
- Easy to apply, environmentally safe and offers exceptional protection
- Unlimited dry time to launch: can be painted in the fall or winter
- 40% Copper **Specify Color:** • Blue • Green • Red • SeaRay Black

Item	Size	Ship	Net	Item	Size	Ship	Net
Ⓞ 750429	Gal.	20 lbs	\$154.99	Ⓞ 750428	Qt.	5 lbs	\$69.99

**Antifouling Speedcoating**



**VIVID®**

- Excellent multi-season, dual biocide • Easily burnished to a racing finish
- Hybrid technology combines the benefits of ablative and hard paints
- Clean, bright colors including true White and Black
- Excellent for racing, trailered or rack-stored boats

**Specify Color:** • Black • White • Blue • Red • Yellow • Green/gal. only

Item	Size	Ship	Net	Item	Size	Ship	Net
Ⓞ 750434	Gal.	16 lbs	\$254.99	Ⓞ 750433	Qt.	4 lbs	\$89.99

**Pettit Hard Modified Epoxy**



**TRINIDAD® SR**

- High copper load for unprecedented protection
- If left in the water, Trinidad SR will provide years of dependable service
- Hard durable finish for long lasting performance
- Added PTFE (Polytetrafluoroethylene) for improved performance

**Specify Color:** • SR Blue • SR Green • SR Red • SR Black

Item	Size	Ship	Net
Ⓞ 750421	Gal.	24 lbs	\$271.99



**TRINIDAD ANTI FOULING**

- Proven track record of performance • High cuprous oxide content
- For extreme fouling conditions • Hard, durable, long lasting finish
- If left in the water, Trinidad provides classic, year round service

**Specify Color:** • Blue • Red • Black

Item	Size	Ship	Net
Ⓞ 750423	Gallon	23 lbs	\$249.99

**Pettit Solvent-Based Ablatives**



**ULTIMA SR-60® WITH IRGAROL**

- High copper, dual biocide multi-season ablative
- Highest copper load (60%) available in ablative paint
- Designed for professional applicators • Use thinner #185

**Specify Color:** • Blue • Red • Black • Green

Item	Size	Ship	Net
Ⓞ 750471	Gallon	22 lbs	\$275.99



**ULTIMA SR-40 WITH IRGAROL**

- Ablative technology reduces build-up • High copper load (40%)
- Dual biocides provide excellent multi-season performance

**Specify Color:** • Blue • Green • Red • Black

Item	Size	Ship	Net
Ⓞ 751440	Gallon	18 lbs	\$245.99

**Underwater Metal Prep & Paint**



**PROP COAT BARNACLE BARRIER 1792**

- Formerly Zinc Coat Barnacle Spray. Use on bare metals including steel, Stainless Steel, cast iron, copper, bronze, lead and galvanized steel. Excellent bond to running gear. Smooth, self-cleaning finish.

Item	Model	Size	Ship	Net
Ⓞ 754317	1792	16 oz. spray	2 lbs	\$25.99
Ⓞ 756898	1792	Quart brushable	5 lbs	\$84.99



**ALUMASPRAY® PLUS**

- 12 oz. aerosol Black antifouling paint for aluminum outdrives and outboards. Slime resistant and excellent for underwater metals.

Item	Size	Ship	Net	
Ⓞ 755305	1863	12 oz.	1 lbs	\$33.99



**TIE COAT PRIMER 6627**

- Chlorinated rubber type primer for metal or as a tie coat between different types of coatings. Compatible with Pettit antifouling and topside paints.

Item	Size	Ship	Net	
Ⓞ 750335	6627	Quart	4 lbs	\$37.99



**RUSTLOK STEEL PRIMER 6980**

- Moisture and corrosion-proof primer for use on all cast iron and steel surfaces including Stainless Steel and galvanized. Wets, seals and adheres to firmly attached rust.

Item	Size	Color	Ship	Net
Ⓞ 750247	6980	Gallon	10 lbs	\$98.99
Ⓞ 750236	6980	Quart	3 lbs	\$36.99



**BLACK WIDOW**

- Hard, slick, burnishable racing finish
- Slickest, fastest, and easiest to clean racing paint
- Provides high performance, multi season, dual biocide antifouling protection

Item	Size	Color	Ship	Net
Ⓞ 756717	Gallon	Black	15 lbs	\$284.99
Ⓞ	Quart	Black	4 lbs	\$89.99



### PETTIT PROTECT EPOXY PRIMER



- 2-part formula
- Faster and easier application
- Comprehensive gelcoat blister repair and prevention
- High-build formula covers in 2 coats vs the competitors' 5 or 6 coats
- Exclusive Low-VOC formula developed specifically for friendly application
- Can also be used on all underwater metals to provide dependable corrosion protection

Item	Size	Ship	Net
Ⓞ 750440	Gallon (Gray or White)	14 lbs	\$96.99
Ⓞ 750442	Quart (Gray)	4 lbs	42.99

### Repair Epoxies & Fairing Compound



#### SPLASH ZONE A-788

- Two-part, multi-purpose epoxy patching and repair compound
- Use above or below waterline • Stops erosion and deterioration
- Seal, fill, patch/re-build aluminum, wood, concrete, fiberglass, epoxy repair and steel

Item	Model	Size	Ship	Net
Ⓞ 755833	A-788	1/2 Gallon, 2-part	9 lbs	\$81.99
Ⓞ 755905	A788	32 oz., 2-part	4 lbs	51.99



#### PETTIT EZ-BOND HIGH-STRENGTH MARINE BONDING EPOXY GLUE

- Two-part thickened epoxy glue • Applications: Bonding wood, fiberglass, composites and even metals • EZ -Bond uses a unique resin specifically engineered for maximum adhesion • For high stress bonds, the resin is also non -brittle and will resist cracking

Item	Model	Size	Ship	Net
Ⓞ 756722	7080	250 ml cartridge	1 lbs	\$23.99



#### FLEXPOXY 7076

- Two-part flexible repair and construction epoxy resin
- For large or small repairs • Use above/below the waterline
- Does not sag, run or shrink • Remains flexible when cured
- Low odor formula • Can be sanded, drilled and tapped

Item	Model	Size	Ship	Net
Ⓞ 755906	7076	6.45 oz. cartridge, 2-part	1 lbs	\$24.99



#### EZ FAIR 7050

- For fairing, filling and patching • Fast-cure formula
- Allows for quick recoats • Can be easily painted
- Use above or below the waterline • Excellent chemical resistance

Item	Model	Size	Ship	Net
Ⓞ 755831	7050	6.45 oz. cartridge, 2-part	1 lbs	\$26.99
Ⓞ 755832	7050	Quart, 2-part	3 lbs	61.99

### Pettit Surface Prep



#### BIO-BLUE HULL SURFACE PREP 92

- Solvent-free product removes contaminants, grease, wax and mold-release agents from fiberglass surfaces prior to painting
- Easy-to-use, biodegradable formula works on all fiberglass surfaces
- Coverage is approximately 600 sq. ft. / gal.

Item	Size	Ship	Net	Item	Size	Ship	Net
751679	Gallon	11 lbs	\$83.99	751676	Quart	3 lbs	\$35.99



#### EZ PRIME 6149

- Multipurpose, high-solids, topside primer easily hides imperfections
- Ideal for use as a base coat on aged, cracked or pitted surfaces
- One-part fast-covering formula reduces number of coats needed
- Use above waterline under Pettit 1-part and 2-part topside enamels

Item	Size	Ship	Net	Item	Size	Ship	Net
Ⓞ 750240	Gallon	15 lbs	\$77.99	Ⓞ 750310	Quart	4 lbs	\$29.99



#### PETTIT EZ-TEX RAPID CURE MARINE EPOXY REPAIR COMPOUND

- Excellent for filling cracks, gouges and boids
- For permanent repairs above and below the waterline
- Color: Gray, 100% waterproof when cured, Size: 2 ounces

Item	Model	Description	Ship	Net
Ⓞ 756899	7200	Epoxy repair compound	1 lbs	\$14.99



#### ALUMA PROTECT 4400 / 4401

- Corrosion resistant, 2-part epoxy primer for properly prepared aluminum surfaces requiring maximum resistance to fresh or salt water
- Provides excellent bonding surface for additional primers or topcoats
- Color: Bright Yellow

Item	Model	Size	Ship	Net
Ⓞ 756332	4400	3/4 Gallon kit	8 lbs	\$88.99



#### EZ-TEX MARINE EPOXY REPAIR COMPOUND

- Easy to use 1:1 mix ratio repair compound for cracks, gouges, voids and holes High strength formula makes repairs permanent 100% waterproof when cured
- Can be used above and below the waterline
- Will not sag, shrink or run

Item	Model	Size	Ship	Net
Ⓞ 756720	7100	4 oz	1 lbs	\$14.99
Ⓞ	7100	16 oz	2 lbs	34.99

### Topside Finishes

#### PETTIT EZ-POXY/EASYPOXY POLYURETHANE TOPSIDE PAINT

- EZ-Poxy is an exceptionally easy one-part application
- Long lasting, durable polyurethane finish with UV filters
- Produces a gelcoat-like brilliance with a minimum of effort
- E-Z Poxy topside and deck enamel contains silicone for a brilliant shine and easy brush-ability that is more economical, requires less effort and is more forgiving than that of the competition.



**Specify Quart Color:** Semi-Gloss White • Hatteras Off-White • White • Mediterranean White • Hatteras Cream • Fighting Lady Yellow • Fire Red • Burgundy • Platinum • Steel Gray • Seattle Gray • Black • Dark Blue • Ocean Blue • Bikini Blue • Blue Ice • Electric Sapphire Blue • Jade Green • Kelly Green • Dull Dead Grass • Seafoam Green • Sandtone

Item	Size	Ship	Net	Item	Size	Ship	Net
Ⓞ 750431	Quart	3 lbs	\$37.99	Ⓞ 750432	Gallon	11 lbs	\$99.99

**Specify Gallon Color:** Semi-Gloss White • Hatteras Off-White • White • Electric Sapphire Blue  
Other colors available as Special Order • Typically ships within 1 week. Contact Defender with the Pettit model number for the color you desire.

#### EZ-POXY ADDITIVES



Item	Size	Description	Ship	Net
Ⓞ 754721	Pint	9080 Satin Additive for semi-gloss to semi-flat finish	2 lbs	\$27.99
Ⓞ 753653	Pint	9900 Skidless Compound for non-slip surface	1 lbs	21.99

#### PETTIT EZ-POXY PERFORMANCE ENHANCER ADDITIVE

- Applications: All Pettit High Gloss Solvent Based Topside Paints and Varnishes
- Function: Adds Exceptional Durability, Gloss, Hardness, Retention and more

Item	Size	Description	Ship	Net
Ⓞ 756718	1/2 Pint	3021 Perf Enhancer for scratch resistance and shine	1 lbs	22.99

#### PETTIT EZ-DECKS

- Provides a super tough, non-skid, polyurethane finish
- Extremely easy to apply, durable weather-resistant finish
- Fade and UV resistant colors hold up under tough conditions

**Specify Color:** White or Platinum Gray

Item	Size	Ship	Net
Ⓞ 755704	Gallon	12 lbs	\$99.99
Ⓞ 755703	Quart	3 lbs	41.99



### Interior Paints & Trailer Paint

#### PETTIT EZ CABIN-COAT®

- High-performance coating for interior surfaces prone to moisture
- Super tough mold and mildew-proof finish
- Adheres to most glossy surfaces without prior sanding
- Water-based, easy to apply and dries fast with low odor
- Ideal for cabin interiors, heads, lockers and cabinets

**Color:** White

Item	Size	Ship	Net
Ⓞ 755700	Quart	3 lbs	\$34.99



#### PETTIT EZ-BILGE®

- High-performance alkyd coating specially designed for boat bilges
- Tough finish resists engine oil, antifreeze, diesel fuel and gasoline
- High-solids formula is easy to apply and provides excellent coverage
- Superior protection that withstands tough bilge conditions

**Specify Color:** Gray or White

Item	Size	Ship	Net
Ⓞ 756770	Gallon	11 lbs	\$76.99
Ⓞ	Quart	3 lbs	29.99



### Thinners

#### BRUSHING THINNER 120 / T-10

- General purpose thinning for enamels and varnish for easy application
- Surfaces can be washed with this thinner prior to prep or painting
- Add up to 10% of thinner to any solvent based Pettit products

Item	Size	Ship	Net	Item	Size	Ship	Net
Ⓞ 750345	Gallon	8 lbs	\$48.99	Ⓞ 750344	Quart	3 lbs	\$21.99



#### SPRAYING THINNER 121 / T-8

- Use to reduce enamels and undercoaters for spray applications
- Add about 10% thinner to epoxy primers when necessary

Item	Size	Ship	Net	Item	Size	Ship	Net
Ⓞ 750347	Gallon	8 lbs	\$53.99	Ⓞ 750346	Quart	3 lbs	\$23.99



#### EPOXY THINNER 97

- Fast-evaporating thinner allows two-part epoxies to flow smoothly
- Flashes off fast enough to prevent sags
- Add about 10% thinner to epoxy primers when necessary

Item	Model	Size	Ship	Net
Ⓞ 750274	97	Quart	3 lbs	\$25.99

# PROTECTING BOATERS FOR GENERATIONS

The hero your boat deserves!  
interlux.com



Visit our website for more information: [interlux.com](http://interlux.com) or call our Technical Service Help Line: 1 800 468 7589

AkzoNobel

PAINTS • Interlux Bottom Paints



**MICRON® CSC**

- Long lasting protection
- Proven performance for over 25 years
- Best value for Micron

**Specify Color:** Blue • Red • Black • Green • Shark

Item	Size	Ship	Net
Ⓞ 752822	Quart	5 lbs	\$74.99
Ⓞ 752823	Gallon	16 lbs	214.99

\*Gallons only



**MICRON CF (COPPER FREE)**

- Bright colors - multi seasonal protection
- Use on all power and sail boats - including aluminum
- Biolux® technology to help block slime and algae

**Specify Quart Color:** White • Black

**Specify Gallon Color:** Shell White • Blue • Red • Black • Green

Item	Size	Ship	Net
Ⓞ 756067	Quart	4 lbs	\$79.99
Ⓞ 756066	Gallon	15 lbs	234.99



**MICRON WA**

- Premium water-based antifouling
- Water-activated technology provides excellent multi season performance.
- Vibrant color and uniform appearance

**Specify Color:** • Blue • Red • Black • Green

Item	Size	Ship	Net
Ⓞ 756731	Quart	6 lbs	\$65.99
Ⓞ 756732	Gallon	21 lbs	159.99



**MICRON 66®**

- Do NOT use in freshwater
- Patented SPC copolymer technology provides the best antifouling protection, even when tied to the dock
- Multi-season protection; polishes away; haul and relaunch

**Specify Color:** • Blue • Red • Black • Green

Item	Size	Ship	Net
Ⓞ 752827	Gallon	14 lbs	\$304.99



**MICRON EXTRA**

- Premium, multi-season copolymer antifouling for harshest fouling areas
- Boosted with Biolux technology to block slime
- Controlled polishing - gets smoother with time maximizing fuel efficiency

**Specify Color:** Black • Shark White • Blue • Dark Blue • Green • Red • Brown (Dark Blue and Brown not available in quarts)

Item	Size	Ship	Net
Ⓞ 752824	Qt.	5 lbs	\$85.99
Ⓞ 752825	Gal.	17 lbs	\$249.99

## Ablative



**PACIFICA® PLUS (COPPER-FREE ANTIFOULING WITH ECONEA)**

- Copper-free ablative combines Biolux slime-blocking technology with Econeal for control of shell growth
- Polishing action for improved fuel efficiency
- Available in clean, crisp, bright colors
- Suitable for all substrates, including aluminum

**Pint Color:** Black or Gray **Quart Color:** Black

**Gallon Color:** Red • Blue • Black • Green • Gray

Item	Size	Ship	Net
Ⓞ 756068	Pint	2 lbs	\$41.99
Ⓞ 756069	Quart	4 lbs	81.99
Ⓞ 755613	Gallon	13 lbs	199.99



**ACT ANTIFOULING BOTTOM PAINT**

- Ablative technology provides excellent season-to-season protection
- Eliminates paint build-up and need for heavy sanding
- Effective control of shell fouling, such as barnacles and zebra mussels
- Can be used in fresh, salt and brackish water

**Specify Quart Color:** • Blue • Black

**Specify Gallon Color:** • Red • Green • Brown • Blue • Black

Item	Size	Ship	Net
Ⓞ 756612	Gallon	19 lbs	\$132.99
Ⓞ 756613	Quart	5 lbs	57.99

## Water Based Technology



**FIBERGLASS BOTTOMKOTE AQUA**

- For both continuous in-water use, and haul and re-launch
- Power, sail, racing, inflatables, trailer or rack stored boats in all waters
- Paint indoors and outdoors – low odor
- Easy clean-up: soap and water
- Indefinite launch time: Paint and launch on your schedule

**Specify Quart Color:** • Black

**Specify Gallon Color:** • Black • Blue • Green • Red

Item	Size	Ship	Net
Ⓞ 755779	Quart	5 lbs	\$56.99
Ⓞ 755778	Gallon	18 lbs	132.99



**AQUA-ONE**

- Water-based ablative antifouling protection
- Ablative action: eliminates paint build up and heavy sanding
- Water-based and low V.O.C.
- Use in all waters - salt, brackish and fresh water
- Effective against barnacles and zebra mussels
- Compatible with most other antifouling

**Specify Color:** • Black • Blue • Green • Red

Item	Size	Ship	Net
Ⓞ 756588	Quart	6 lbs	\$44.99
Ⓞ 756589	Gallon	21 lbs	117.99



## Dual Resin Technology

**FIBERGLASS BOTTOMKOTE® NT**

- Dual-resin technology combines optimal benefits of ablative and hard antifouling paints for use on power and sail boats
- Provides clean, stable colors for effective season-long protection
- For use on the underwater areas of fiberglass, wood and properly primed metal (except aluminum) boat hulls
- Can be used in fresh, salt and brackish waters

**Specify Color:** • Black • Blue • Green • Red

Item	Size	Ship	Net
Ⓞ 755644	Qt.	5 lbs	\$42.99
Ⓞ 755645	Gal.	18 lbs	\$94.99



## Hard Traditional Technology

**ULTRA™ WITH BIOLUX With Irgarol®**

- High solids, high-performance, hard antifouling
- Biolux technology reduces slime, enhances antifouling performance
- Durable, fast-drying finish with excellent color stability

**Specify Color:** Black • Red • Green • Blue

Item	Size	Ship	Net
Ⓞ 752829	Gallon	21 lbs	\$189.99



**TRILUX® 33**

- Suitable for all substrates including aluminum, outdrives, outboards, fiberglass, steel and wood
- Uses Biolux technology for improved control of slime

**Specify Color:** • Blue (quart only) • Black • White

Item	Size	Ship	Net
Ⓞ 752833	Qt.	4 lbs	\$79.99
Ⓞ 752834	Gal.	15 lbs	\$249.99



## Performance Coatings/Thin Film

**VC 17M EXTRA WITH BIOLUX (IRGAROL)**

- Hard, super smooth, antifouling finish ideal for racing sailboats and powerboats in fresh or low-fouling salt water
- Includes a Fluoro microadditive for a low-friction surface
- Quick drying for fast relaunch; great for use on inflatables

**Specify Color:** Original • Blue • Red

Item	Size	Ship	Net
Ⓞ 752830	Quart	2 lbs	\$64.99



**VC OFFSHORE**

- Hard, smooth, low-friction antifouling surface formulated for racing sailboats and performance powerboats
- Finish can be burnished for increased performance
- Suitable for fresh, salt and brackish water

**Specify Color:** Blue • Black • Red

Item	Size	Ship	Net
Ⓞ 752831	Gallon	16 lbs	\$299.99



**REGATTA BALTOPLATE RACING FINISH**

- Specialized antifouling finish with the smoothness and lubricity of a superior racing finish in one coating
- Suitable for use in all waters, on all substrates except aluminum
- Color: Gray, Metallic

Item	Size	Ship	Net
Ⓞ 750175	Gallon	16 lbs	\$304.99

SHOP 24/7 AT WWW.DEFENDER.COM



## InterProtect Barrier Coat Systems

### INTERPROTECT® 2000E/2002E

Interprotect 2000E with Micro-Plates® is a unique two-part epoxy coating developed to protect fiberglass hulls from water absorption which can lead to osmotic blistering.

- Micro-Plates create an overlapping barrier to help stop water migration through the coating
- Can be used above or below the waterline as a universal primer for all surfaces (including metal)
- Part of the ultimate no-sand system and can be used to prime underwater metals
- Available in two colors so you can alternate colors to ensure full coverage



Item	Description	Ship	Net
ⓐ 756844	White or Gray quart kit	4 lbs	\$39.99
ⓐ	White or Gray gallon kit	14 lbs	99.99

### INTERPROTECT HS

- Versatile high-solids, two-part epoxy primer
- For above and below the waterline
- Micro-Plate technology reduces water migration through the epoxy to the hull surface which could lead to blistering
- Micro-Plates provide protection from metal corrosion
- High-solids formula means fewer coats required to achieve film buildup and barrier coat
- Color: Gray



Item	Description	Ship	Net
ⓐ 756269	Gallon kit	13 lbs	\$114.99

### WATERTITE® EPOXY FILLER

- 2-part, easy-to-use epoxy compound for filling holes and repairing scratches in gelcoat and fiberglass
- Use above and below the waterline
- Has a long, easy-to-sand window and can be applied to a thickness of 3/4" without sagging
- Superior spreadability makes it an ideal glazing compound for filling small nicks and scratches
- Sand/overcoat in one hour



Item	Model	Size	Ship	Net
ⓐ 756830	YAVI35 KIT	500 ml kit	2 lbs	\$39.99
ⓐ	YAVI35L	1 Liter kit	3 lbs	59.99

## Interlux Surface Prep

### FIBERGLASS SURFACE PREP

- Low VOC contamination/mold release agent remover
- For preparing fiberglass bottoms of new boats or unpainted hulls before applying primers and/or antifouling paints
- Alternative uses are for the removal of amine blush from clear epoxy, cleaning previously painted surfaces prior to sanding, before repainting topside finishes and for preparing inflatable boats for a compatible antifouling paint system



Item	Model	Size	Ship	Net
ⓐ 756831	YMA601VQ	Quart	3 lbs	\$26.99
ⓐ	YMA601VG	Gallon	10 lbs	81.99

## Non-Antifouling Bottom Coatings

### VC® PERFORMANCE EPOXY

- Two-part epoxy with hard, slick finish ideal for underwater surfaces of dry-sailed racing sailboats and high-performance powerboats
- Fluoro microadditive adds lubricity and eases burnishing
- Use on fiberglass, carbon fiber and properly prepared metals
- Semigloss White only; has no antifouling or foul release properties



Item	Model	Size	Ship	Net
ⓐ 756832	V127 KIT	2-part (1 qt each)	6 lbs	\$59.99

## Specialty Antifouling

### TRILUX 33 AEROSOL

Trilux 33 aerosol is the highest performance aerosol antifouling available. It has been formulated specifically for aluminum outboards, outdrives and can be used on all underwater metals. Biolux technology is used to control slime growth. Prime bare metal with Primocon. Trilux 33 aerosol is for use in fresh, salt and brackish water.

Item	Color	Size	Ship	Net
ⓐ 753930	Please specify Black, White or Gray	12 oz.	3 lbs	\$34.99

### PRIMOCON® AEROSOL UNDERWATER PRIMER

A non-bleeding, anti-corrosive primer that provides an excellent barrier on underwater metal surfaces, reducing galvanic corrosion. Use on underwater metal areas including aluminum outdrives and outboards, stainless steel, bronze props and shafts prior to application of Pacifica Plus, Trilux 33 aerosol or Trilux 33. Use at least one full can of primer per lower unit.

ⓐ Item 754719	YPA985N	12oz. Gray	Ship 1 lbs	Net \$26.99
---------------	---------	------------	------------	-------------



## Thinners, Solvents and Cleaners

**SPECIAL THINNER 216** is a fast evaporating solvent that improves drying in cold climates and facilitates spray application. It is also used for removing sanding residue from hull bottoms, wiping bare aluminum clean and general clean-up of painting equipment.

Item	Size	Ship	Net
ⓐ 756833	Pint	2 lbs	\$13.99
ⓐ	Quart	3 lbs	18.99
ⓐ	Gallon	8 lbs	37.99

**BRUSHING LIQUID 333** is a slow drying solvent that improves flow and extends drying time in hot weather. It is also used for removing sanding residue from fiberglass and wood surfaces.

ⓐ 756834	Pint	2 lbs	\$15.99
ⓐ	Quart	3 lbs	22.99
ⓐ	Gallon	8 lbs	42.99

**BRUSH-EASE 433** is a slow drying solvent to ease brushing, rolling and improve flow. It is also for use with specific antifouling paints. It is NOT an all-purpose solvent.

ⓐ 754197	Quart	3 lbs	\$19.99
----------	-------	-------	---------

**REDUCING SOLVENT 2316N** is a fast evaporating solvent for use with two-part polyurethane and epoxy paints. Spray thinner.

ⓐ 756835	Quart	3 lbs	\$19.99
ⓐ	Gallon	8 lbs	47.99

**REDUCING SOLVENT 2333N** is a slow evaporating solvent.

It is for use with two-part polyurethane and epoxy paints.

ⓐ 750103	Quart	3 lbs	\$27.99
----------	-------	-------	---------

**FIBERGLASS SOLVENT WASH 202** is slow evaporating and removes surface contamination from bare fiberglass such as mold release agents, wax, oil and grease. It is also an effective brush cleaner.

ⓐ 756836	Quart	3 lbs	\$20.99
ⓐ	Gallon	9 lbs	51.99



## Metal Preparation

### OSBORNES BARNACLE REMOVER

- Removes stubborn barnacles and marine growth from running gear
- Effective organic salt based alternative to hydrochloric acid
- Applications: Running gear (Shafts, rudders, trim tabs and propellers)

Item	Model	Size	Ship	Net
ⓐ 756742	03-BD-16	16 oz. spray bottle	2 lbs	\$17.99



## Paint Strippers and Removers

### PEEL AWAY® SMART STRIP™ PAINT REMOVER

- 100% biodegradable, water-based paint stripper
- Removes marine paints without damaging gel coat
- Average coverage: 50 square feet per gallon

Item	Model	Size	Ship	Net
ⓐ 756839	3332	1 Qt.	3 lbs	\$18.99
ⓐ	3301	1 Gal.	9 lbs	58.99
ⓐ	3305	5 Gal.	44 lbs	254.99



### PEEL AWAY MARINE SAFETY STRIP

Safe for the environment. No harmful fumes. WILL remove barrier coat. Removes most anti-fouling paint, other paint and varnish from fiberglass, wood, metal, glass. Will not harm gelcoat, wood or other surfaces. Coverage is approx. 40-50 sq. ft. per gallon.

Item	Description	Ship	Net	
ⓐ 756840	1 Gallon with cloths	13 lbs	\$69.99	
ⓐ	5 Gallon with cloths	58 lbs	309.99	
	751773	10 Removal cloths	1 lbs	20.99



### PEEL AWAY MARINE STRIP

An alternative to Peel Away Marine Safety Strip for removing bottom paint and keeping the epoxy barrier coat intact. Removes multiple layers of bottom paint in ONE application, but will not affect the barrier coating, so you can repaint without the need to re-epoxy. Includes Peel away sheets for covering during removal process. Coverage is 20 sq. ft per gallon.

Item	Description	Ship	Net
ⓐ 756841	1 Gallon	12 lbs	\$44.99
ⓐ	5 Gallon	63 lbs	149.99



Most cans of paint, varnish and resin ship with NO Hazmat fees! More convenient and cheaper than a trip to the local store!



**AQUAGARD/FLEXDEL ARMOR ANTIFOULANT BOTTOM PAINT**

- Copper free
- Dual biocide prevents slime and algae
- For fiberglass, wood and aluminum
- Contains E-cone® 5.6%
- Multi-season ablative

**Specify Color:** Black • Blue • Red • White

Item	Size	Ship	Net
Ⓞ 756828	Pint (Black only)	2 lbs	\$32.99
Ⓞ	Quart	3 lbs	49.99
Ⓞ	Gallon	11 lbs	149.99



**AQUAGARD BOTTOM PAINT WATERBASE ANTIFOULING PAINTS**

- Designed for fiberglass and wooden boats
- Ablative action repels barnacles and other marine growth
- Fast drying • Rolls on easily • Soap and water clean-up
- Exceeds VOC standards • Controlled leach out • Non-toxic fumes
- Also for use on inflatable boats without the use of primer

**Specify Color:** Red • Blue • Black • Green • Shark White

Item	Size	Ship	Net
Ⓞ 756846	Quart	4 lbs	\$37.99
Ⓞ	Gallon	13 lbs	114.99
Ⓞ	2 Gallon	27 lbs	179.99



**FLEXDEL BOTTOM GARD PAINT**

- Solvent based ablative antifouling
- For fiberglass and wooden boats

**Specify Color:** Black, Blue or Red

Item	Size	Ship	Net
Ⓞ 752506	Gallon	13 lbs	\$79.99



**AQUAGARD ALUMI-KOAT ANTIFOULING PAINT**

- Offers superior adhesion to aluminum – no barrier coat required
- Ablative, acrylic copolymer specially formulated for aluminum hulls
- Water-based and environmentally friendly
- Requires 190 Primer if going on bare aluminum

**Specify Color:** Black, Blue, Red or White

Item	Size	Ship	Net
Ⓞ 754927	Gallon	11 lbs	\$169.99

**SeaHawk Bottom Paints**



**BIOCOP TF™ Advanced Dual Biocide for Maximum Protection**

- Slime reducing additive for Cukote™ or AF33™
- Harder, self-polishing, boosted ablative antifoulant for longer life
- Multi-season performance • Dual biocide • For fresh or saltwater
- Add 1 pint of Biocop TF per gallon of Cukote or AF-33

**Specify Color:** Black • Gray • Light Blue • Red • Dark Blue (gallon only) • Teal (gallon only) • Green (gallon only)

Item	Size	Ship	Net
Ⓞ 756888	Pint	2 lbs	\$42.99
Ⓞ 756529	Gallon	17 lbs	274.99



**CUKOTE Self-Polishing Copolymer Antifoulant– 3400 Series**

- High load of cuprous oxide makes this a top antifoulant performer
- Multi-season performance
- Take in and out of water without affecting antifouling characteristics

**Specify Color:** • Black • Dark Blue • Green • Blue • Red • Shark White (gallon only) Teal (gallon only)

Item	Size	Ship	Net
Ⓞ 756249	Quart	5 lbs	\$69.99
Ⓞ	Gallon	19 lbs	194.99



**AF-33 Multi-Season Formula – 3300 Series**

- A harder ablative antifoulant for a more durable finish
- Highest grade of cuprous oxide available

**Specify Color:** Black • Dark Blue • Green • Blue • Red

Item	Size	Ship	Net
Ⓞ 756247	Quart	4 lbs	\$42.99
Ⓞ	Gallon	16 lbs	131.99



**SMART SOLUTION™ Copper-Free • Metal Free – 4700 Series**

- Utilizes completely METAL-FREE biocides
- The coating's reaction to salt water creates a film that encapsulates the hull for enhanced speed and performance against growth
- Compatible over existing antifoulants

**Specify Color:** Black • Bright Green • Bright Blue • Bright Red • Dark Blue • White

Item	Size	Ship	Net
Ⓞ 756253	Pint (Black or Gray)	2 lbs	\$36.99
Ⓞ	Quart	3 lbs	63.99
Ⓞ	Gallon	12 lbs	199.99



**MONTEREY™ Water-Based • Low VOC's – 5400 Series**

- Solvent-free antifouling
- Highest grade of cuprous oxide available
- Harder ablative finish (lasts longer on higher speed vessels)
- May be applied over other ablative antifoulant paints

**Specify Color:** Black • Dark Blue • Green • Blue • Red

Item	Size	Ship	Net
Ⓞ 756252	Quart (Black, Blue, Dark Blue)	6 lbs	\$50.99
Ⓞ	Gallon	21 lbs	139.99

**Aquagard®**



**AQUAGARD/FLEXDEL ULTRAGARD PREMIUM ANTI-FOULING PAINT**

- For fiberglass, steel & wooden boats
- High copper load; 37.5%
- Ablative action repels barnacles & other growth
- Can be applied over most other antifoulings
- EPA approved
- Full season ablative protection

**Specify Color:** Black • Blue • Red

Item	Size	Ship	Net
Ⓞ 756866	Quart	5 lbs	\$39.99
Ⓞ	Gallon	17 lbs	99.99



**AQUAGARD ALUMI-KOAT PRIMER**

- For outboards and lower units
- Creates a barrier to stop slime build-up, barnacle and marine growth
- For use on aluminum and other non-ferrous materials
- Requires 181 primer if used on bare aluminum

**Specify Color:** Black • Off White • Clear

Item	Size	Ship	Net
Ⓞ 752469	12 oz.	1 lbs	\$34.99



**AQUAGARD 190 WATERBASED PRIMER**

- For aluminum, fiberglass, or wooden surfaces
- Exceeds VOC standards
- For use with all Aquagard bottom paints

**Specify Color:** Black • Blue • Red

Item	Model	Size	Ship	Net
Ⓞ 751326	25009	Quart	3 lbs	\$32.99



**AQUAGARD 181 PRIMER**

- For fiberglass, aluminum and wooden surfaces
- Only requires one coat
- Formulated to be used prior to antifouling paint
- Excellent resistance to the marine environments, corrosion and salt

**Color:** Medium Gray

Item	Size	Ship	Net
Ⓞ 756845	Quart	3 lbs	\$29.99
Ⓞ	Gallon	9 lbs	79.99

**SeaHawk Primers and Barrier Coats**

**TUFF STUFF HIGH-BUILD EPOXY PRIMER**

Premium Blister Protection with Microsheet Silicate Technology

- High-build, two-part epoxy primer that dries fast
- Complete barrier system and bottom paint in two days
- Use over blistered fiberglass as a repair coat, and over unblistered fiberglass as a barrier coat
- Protects metals from corrosion above and below the waterline

**Specify Color:** Gray • White (gallons only)

Item	Size	Ship	Net
Ⓞ 756257	2-Part 2-Quart kit	6 lbs	\$60.99
Ⓞ	2-Part 2-Gallon kit	24 lbs	169.99



**SEAHAWK TUFF STUFF LOW VOC HIGH-BUILD EPOXY PRIMER**

The Tuff Stuff LOW VOC Epoxy Primer complies with rigid CARB VOC limits and offers a Low VOC alternative when applying water barrier or corrosion protection.

**Specify Color:** White • Gray

Item	Size	Ship	Net
Ⓞ 756657	2-Part 1- Gallon Kit	14 lbs	\$99.99

**SEAHAWK BARRIER COAT PRIMER**

This high-build, chlorinated, yellow rubber-based primer is recommended for use over old copper-based antifoulants before recoating. Provides excellent corrosion resistance over metal and fiberglass. A great insurance policy if old paint is unknown.

**Color:** Yellow

Item	Size	Ship	Net
Ⓞ 756865	1277 Quart	3 lbs	\$26.99
Ⓞ	1277 Gallon	11 lbs	74.99

**SeaHawk Aluminum Paint**

**SEA HAWK ALUMA HAWK™**

- Quick-dry, high-solids, corrosion-inhibiting coating
- Designed for use on aluminum with no need for primers
- Can be used above or below the waterline (salt or fresh water)
- Contains NO antifouling characteristics

**Specify Color:** Flat (Jon Boat) Green • Flat Gray • Flat Black

Item	Size	Ship	Net
Ⓞ 756380	Quart	6 lbs	\$37.99



**NON-SKID DECK COATING**

KiwiGrip Non-Skid Deck Systems

- Water based non-skid coating
- For use on wood, fiberglass, epoxy, concrete or metal
- Hard acrylic polymer providing a durable, homogeneous, elastic surface
- Will not wear through and expose filler materials
- Kit includes 4" application roller

**Specify Color:** White, Cream, Light Gray and Light Blue

Item	Size	Ship	Net
756523	1 Liter	4 lbs	\$43.99
756524	4 Liter	14 lbs	147.99
756789	Spare 4" roller brush	1 lbs	9.49





## INTERLUX PRIMERS & ADDITIVES

### INTERLUX® INTERGRIP® NO SKID COMPOUND

Non-skid additive for topside paints.

Item	Size	Ship	Net
Ⓞ 755124	Half pint	1 lbs	\$19.99

### INTERLUX PRE-KOTE® PRIMER - White or Gray (gallon White only)

Ⓞ 751341	Quart	4 lbs	31.99
Ⓞ 750170	Gallon (White)	13 lbs	96.99

### INTERLUX FLATTENING AGENT - For 1 part finishes

Ⓞ 754993	Quart	3 lbs	\$36.99
----------	-------	-------	---------

Most cans of paint, varnish and resin ship with NO Hazmat fees!  
More convenient and cheaper than a trip to the local store!



## TOPSIDE PAINTS

### INTERLUX PERFECTION®

- High performance, 2-part polyurethane high-gloss finish
- Long lasting finish with superb color retention
- Excellent chemical, impact and abrasion resistance
- Formulated specifically for professional results with ease
- For use on topsides, superstructures and decks

**Specify Color:** Snow White, Mediterranean White, Arctic White, Off White, Cream, Oyster White, Platinum, Lauderdale Blue, Mauritius Blue, Flag Blue, Rochelle Red, Jet Black, Royal Blue, Matterhorn White, Jade Mist Green or Fighting Lady Yellow

Item	Description/Size	Ship	Net
Ⓞ 752842	Perfection - Quart	4 lbs	\$76.99
Ⓞ 755133	Flattening agent - Quart	3 lbs	49.99
Ⓞ 750103	Reducing solvent - Quart	3 lbs	27.99



### INTERLUX BRIGHTSIDE® POLYURETHANE

Brightside is a one-part polyurethane topside finish that has the ease of use of an enamel with the high gloss of a two-part polyurethane.

**Specify Color:** White, Off-White, Matterhorn White, Blue-Glo White, Sapphire Blue, Dark Blue, Light Blue, Medium Blue, Flag Blue, Yellow, Kingston Gray, Seattle Gray, Steel Gray, Bristol Beige, Grand Banks Beige, Sundown Buff, Sea Green, Fire Red, Black, Largo Blue, Ocean Blue, Hatteras Off-White (for Hatteras yachts 1965-1989) or Hatteras Off-White (for Hatteras yachts 1990-present)

**NOTE:** Gallon: (Blue-Glo or White only)

Item	Size	Ship	Net	Item	Size	Ship	Net
Ⓞ 752839	Qt.	3 lbs	\$38.99	Ⓞ 752840	Gal.	11 lbs	\$105.99



### INTERLUX PREMIUM YACHT ENAMEL™

Low-cost general use marine paint. 1 part enamel. Best value in the USA.

**Specify Color:** High Gloss White or Semi-Gloss White

Item	Size	Ship	Net	Item	Size	Ship	Net
Ⓞ 752836	Quart	3 lbs	\$31.99	Ⓞ 752837	Gallon	11 lbs	\$77.99



## BOOT STRIPE PAINT

### INTERLUX BRIGHTSIDE BOOT TOP & STRIPING ENAMEL

- Premium one-part topside polyurethane with hard, high-gloss finish
- Superior color retention, abrasion resistance and durability

**Specify Color:** Black, Flag Blue, Fire Red or White

Item	Size	Ship	Net
Ⓞ 752838	1/2 pint	1 lbs	\$21.99



## Propspeed® Foul Release

Propspeed is the original propeller and running gear coating system specially formulated to prevent marine growth from bonding to metal surfaces below the water line. Unlike conventional antifouling paint which does not adhere well to underwater metal, or when it does, reduces performance, this unique, environmentally-friendly, two-part coating system bonds to your boat's propeller and running gear with no recoating needed for a year or more. Its "foul release" formulation reduces drag by preventing marine growth from attaching, resulting in fuel savings, and improved top end speed and performance. Easily applied by an experienced applicator, well versed "do-it-yourselfers" can also apply this coating by following the included application guide. Propspeed can be used on boats of all types and sizes, both recreational and commercial, from sport-fishers, cruisers, sailboats and superyachts to work boats like ferries, trawlers, tugboats and patrol boats. Propspeed is effective on propellers, rudders, shafts, struts, trim tabs, IPS drives, thrusters, keel coolers or any underwater metal surface.

Ⓞ Item 756873	Model PRS RPS200	200ml DIY Prop Kit	Ship 2 lbs	\$224.99
Ⓞ	Model PRS RPS500	500ml DIY Prop Kit	2 lbs	339.99

## DECK PAINTS

### INTERLUX INTERDECK® NON-SKID FINISH

- Provides a slip-resistant finish using a tough polyurethane resin
- Protects decks against everyday wear and tear
- Contains a fine aggregate material and applies easily to all substrates
- Has a low sheen finish to reduce sun glare
- Good for use on fiberglass, wood and properly primed metals

**Specify Color:** White, Cream, Gray, or Sand Beige

Item	Size	Ship	Net
Ⓞ 752843	Quart	4 lbs	\$37.99



## BILGE PAINTS

### INTERLUX BILGEKOTE®

- Specifically for bilge areas and bulkheads
- Helps prevent absorption of oil and gas into wood and fiberglass
- Water and chemical resistant

**Specify Color:** White or Gray

Item	Size	Ship	Net
Ⓞ 752845	Quart	3 lbs	\$29.99
Ⓞ 752848	Gallon	11 lbs	74.99



## PRIMERS & BEDDING COMPOUNDS

### INTERLUX EPOXY PRIMEKOTE®

- Multi-purpose two-part bright White epoxy primer
- For use above the waterline
- Excellent undercoat for Perfection
- Use over clear epoxies to reduce effects of amine blush

Item	Model	Size	Ship	Net
Ⓞ 750032	404 KIT	Quart	4 lbs	\$40.99
Ⓞ 750091	404 KIT	Gallon	13 lbs	112.99



### INTERLUX PRIMOCON UNDERWATER PRIMER

- Use on underwater areas of aluminum outdrives and outboards or any underwater metal surfaces
- Non-bleeding, anti-corrosive (reduces galvanic corrosion)

Item	Model	Size	Ship	Net
Ⓞ 754691	YPA984	Quart	3 lbs	\$33.99
Ⓞ 754305	YPA984	Gallon	10 lbs	89.99



### INTERLUX SURFACING PUTTY - WHITE

- Fast drying surface compound
- Use on bare wood or fiberglass – good adhesive properties
- Sands easily

Item	Model	Size	Ship	Net
Ⓞ 750030	257	Pint	2 lbs	\$28.99



### INTERLUX BOATYARD BEDDING COMPOUND

- Surface hardens to receive paint but remains soft and pliable underneath for waterproofing and flexibility
- Prevents leaking and rotting between double planking joints
- Color: Natural

Item	Model	Size	Ship	Net
Ⓞ 750157	214	Quart	4 lbs	\$40.99



### DOLFINITE® BEDDING COMPOUND

- Creates a waterproof seal; doesn't harden, soften or ooze
- For use on wood, fiberglass and metal surfaces
- May be painted after the compound has firmly skinned over

Item	Model	Size	Ship	Net
Ⓞ 753802	2005N	Quart	5 lbs	\$44.99

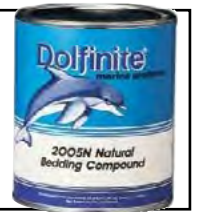

## VELOX PLUS

### VELOX PLUS ANTIFOULING COATING SYSTEM

- Velox Plus is an antifouling coating developed to protect propellers, stern drives, shafts, outdrives, struts, jet pumps and other metallic parts that are in the water
- Repairable!
- No maximum time between coats

**Specify Color:** White or Black

### 0.25L Primer / 0.5L Velox Plus Kit

Item	Ship	Net
Ⓞ 756493	4 lbs	\$126.99

- Includes: primer, paint, 3x brushes, 6x gloves, 2x stir sticks, 2x 1qt mixing cups
- Velox Metal Primer and Velox Plus are available a la carte via [www.defender.com](http://www.defender.com)



### VELOX PLUS PROP PAINT

- Antifouling paint for propellers and underwater running gear
- Formulated to not be degraded by galvanic currents

**Specify Color:** White or Black

Ⓞ Item 756494	.25 liter can	Ship 1 lbs	Net \$56.99
Ⓞ Item 756495	.5 liter can	2 lbs	86.99



## Sikkens Cetol Marine Products



Item	Size	Finish	Ship	Net
Ⓞ 751238	Quarts	Marine Gloss	3 lbs	\$36.99
Ⓞ 756655	Quarts	Please specify Marine Light, Marine or Natural Teak	3 lbs	34.99
Ⓞ 756681	Gallons	Please specify Marine or Natural Teak	9 lbs	114.99

**Sikkens Cetol Marine** is formulated with a special alkyd resin and high quality synthetic UV-absorbing pigments. It produces an attractive dark amber appearance on wood.

**Cetol Marine Natural Teak** has a golden color that will enhance the natural beauty and grain of wood. It is formulated for the same ease of application as all Cetol Marine products but with Next Wave™ UV-absorbing technology. It is natural looking and does not darken or change the color or grain of the wood.

**Sikkens Cetol Marine Gloss** provides a high gloss, hard-wearing UV protection and an easy-to-clean finish. It is developed as a topcoat for Cetol Marine, Cetol Marine Light and Cetol Marine Natural Teak for whenever a gloss finish is desired. Do not use on decks.

## Interlux Varnish & Wood Treatments



**INTERLUX® SCHOONER® GOLD VARNISH** is a long lasting, 1-part varnish formulated using an optimized blend of premium UV absorbers and resins to ensure that the deep gloss and color are retained. Developed as a high gloss yacht varnish, it has a traditional amber hue.

Item	Size	Ship	Net	Size	Ship	Net
Ⓞ 756682	Pint	2 lbs	\$24.99	Quart	4 lbs	\$43.99

**INTERLUX COMPASS® CLEAR VARNISH** is a 1-part polyurethane gloss varnish that contains UV additives, HALS, surface stabilizers and antioxidants to ensure long term gloss and clarity. It is suitable for all internal and external woods and can be applied directly to oily wood.

Item	Size	Ship	Net	Size	Ship	Net
Ⓞ 756683	Pint	2 lbs	\$21.99	Quart	3 lbs	\$31.99

**INTERLUX SCHOONER VARNISH** combines classic beauty with ultraviolet filters for remarkable durability. It offers a high gloss finish, is easy-to-apply and has a warm golden color. It also provides water resistance and superior self-leveling properties.

Item	Size	Ship	Net	Size	Ship	Net
Ⓞ 756684	Pint	2 lbs	\$23.99	Quart	3 lbs	\$34.99

**INTERLUX GOLDSPAR SATIN® VARNISH** is for interior applications. It has a warm, rich color, low luster finish and is easy to apply. It is also scratch and stain resistant.

Item	Size	Ship	Net	Size	Ship	Net
Ⓞ 756685	Pint	2 lbs	\$19.99	Quart	3 lbs	\$33.99

**INTERLUX ORIGINAL® VARNISH** is designed for interior or exterior, is easy-to-apply, has a good gloss and a traditional golden color.

Item	Model	Size	Ship	Net
Ⓞ 753848	90	Quart	3 lbs	\$21.99

**INTERLUX CLEAR 2 PART WOOD SEALER** Clear polyurethane primer with excellent grain-filling properties. High gloss, fast drying formula allows multiple coats in one day.

Item	Model	Description	Size	Ship	Net
Ⓞ 752331	YVA328	Part A Curing Agent	Quart	3 lbs	\$53.99
Ⓞ 752339	YVA327	Part B Fast Drying Base	Quart	3 lbs	34.99

**INTERLUX INTER-PRIME® WOOD SEALER** is for interior or exterior. It seals the grain, preventing high and low spots in varnish and is good for sealing plywood. Clear.

Item	Size	Ship	Net
Ⓞ 750099	Quart	2 lbs	\$24.99

**INTERLUX INTERSTAIN® PASTE WOOD FILLER STAIN** fills the grain of the wood and stains it. By filling the wood, the number of varnish coats can be reduced. All ship 2 lbs.

Item	Color	Size	Net
Ⓞ 756686	Brown Mahogany	Pint	\$28.99
Ⓞ	Red Mahogany	Pint	27.99
Ⓞ	Chris-Craft Red Mahogany	Pint	27.99

**INTERLUX PERFECTION® PLUS VARNISH** is a clear, 2-part polyurethane with prolonged chemical and abrasion resistance, superior UV protection and high gloss retention (well over 80% after 12 months in Florida). It can be applied direct to substrate or alternatively used with Clear Wood Sealer.

Item	Size	Ship	Net
Ⓞ 753931	Quart	6 lbs	\$83.99

## Epifanes Varnish & Wood Treatments

### EPIFANES® RAPIDCOAT AND RAPIDCLEAR

- Interior or exterior • Lightly tinted or clear semi-gloss finish for all woods • Can be applied every 5-6 hours • Minimum three coats
- No sanding required • A quick and easy stand-alone finish, or use to temporarily touch up other varnish systems

Item	Model	Size	Description	Ship	Net
Ⓞ 756687	RC.750	750 ml	Rapidcoat - tinted	2 lbs	\$39.99
Ⓞ	RCC.750	750 ml	Rapidclear	2 lbs	39.99

### EPIFANES HIGH GLOSS CLEAR VARNISH

- World famous, highest quality marine spar varnish • Interior or exterior • Chinese tung oil, non-yellowing alkyd and phenolic resins blended with UV inhibitors • For use above the waterline

Item	Model	Size	Ship	Net
Ⓞ 756688	CV.250	250 ml	1 lbs	\$16.99
Ⓞ	CV.500	500 ml	2 lbs	26.99
Ⓞ	CV.1.000	1000 ml	3 lbs	39.99
Ⓞ	CV.5000	5000 ml	12 lbs	182.99

### EPIFANES WOOD FINISH GLOSS

- Interior or exterior • Gives a hard, high gloss varnished look without the work • No sanding required if applied within 72 hours
- High build, long lasting for teak and other hard woods
- Formulated for extraordinary protection, even in tropical climates

Item	Model	Size	Ship	Net
Ⓞ 756689	WFG.500	500 ml	2 lbs	\$30.99
Ⓞ	WFG.1000	1000 ml	3 lbs	48.99



### EPIFANES WOOD FINISH MATTE

- Rich matte finish with amber color • Excellent durability and flexibility • Builds up coats quickly • No sanding required if re-coated within 72 hours • Best when applied over multiple coats of Epifanes Wood Finish Gloss, Epifanes Clear Gloss Varnish or Epifanes Polyurethane Clear Gloss

Item	Model	Size	Ship	Net
Ⓞ 756690	WFM.500	500 ml	2 lbs	\$33.99
Ⓞ	WFM.1000	1000 ml	3 lbs	49.99

### EPIFANES RUBBED EFFECT VARNISH

- Interior use • A rich satin luster gives a beautiful, rubbed effect
- Quick-drying finish; based on polyurethane alkyds • Apply to any interior softwood or hardwood • Recommended for cabin sole, doors and trim

Item	Model	Size	Ship	Net
Ⓞ 756691	RE.500	500 ml	2 lbs	\$31.99
Ⓞ	RE.1000	1000 ml	3 lbs	49.99

### EPIFANES THINNERS

- For use with Gloss Varnish, Wood Finish, and after Rubbed Effect, Enamels and Mono Urethane

Item	Model	Size	Ship	Net
Ⓞ 756822	TPVB.500	500 ml (Brush)	1 lbs	\$13.99
Ⓞ	TPVB.1000	1000 ml (Brush)	2 lbs	17.99
Ⓞ	TPVS.1000	1000 ml (Spray)	2 lbs	21.99





## Awlwood MA Exterior Clears System

### AWLWOOD BY AWLGRIP

Awlwood MA is an exterior clear system that is made up of a Primer and Clear Finish. By combining the Primer and Clear together, the synergistic effect results in an outstanding performing system that adheres and bonds directly to the wood cellular structure giving extended performance and retaining the same gloss, DOI and natural appearance as first application.

**Awlwood Primer** - Required before topcoat All ship 3 lbs.

Item	Model	Color	Size	Net
Ⓞ 756946	J3809	Clear	Quart	\$80.99
Ⓞ	J7809	Red	Quart	80.99
Ⓞ	J3809	Yellow	Quart	80.99

### Awlwood Topcoat

Item	Color/Finish	Size	Ship	Net
Ⓞ 756947	Clear Gloss	Gallon	9 lbs	\$289.99
Ⓞ	Clear Gloss	Quart	3 lbs	80.99
Ⓞ 756948	Clear Matt (Satin)*	Gallon	9 lbs	289.99
Ⓞ	Clear Matt (Satin)*	Quart	3 lbs	80.99

\* Gloss required first

### Reducers and Cleaners - All ship 3 lbs

Item	Model	Description	Size	Net
Ⓞ 756943	T0200	Brush Cleaner	Qt.	\$45.99
Ⓞ 756944	AWL T0201	Brushing Reducer	Qt.	39.99
Ⓞ 756945	AWL T0202Q	(up to 10%) Spraying Reducer (up to 10%)	Qt.	39.99



## Rot Repair

### SYSTEM THREE® ROT FIX™ WOOD RESTORATION

Rot Fix is an easy to use, low viscosity epoxy wood sealer, primer and consolidant for repair and restoration of rotted, deteriorated, dried out or spongy wood. Rot Fix is a component of The EndRot Repair and Restoration System. It creates a sound, waterproof base for restoration filler putty. A unique measuring/application bottle is included with each 24 ounce RotFix kit. 2:1 ratio.

Item	Model	Size	Ship	Net
Ⓞ 756778	1500K40	1.5 Pint Kit	3 lbs	\$37.99
Ⓞ	1500K42	1.5 Quart Kit	4 lbs	58.99

### SCULPWOOD® MOLDABLE EPOXY PUTTY

Sculpwood is a solvent free, kneadable epoxy resin putty which is moldable, carvable, lightweight, strong and exhibits excellent adhesion. It is easily sanded and will accept paint, screws and nails. Use for replacing missing sections or for adding new sections to existing structures. Each kit contains 1-part resin and 1-part hardener. Color: Medium Brown.

Item	Model	Size	Ship	Net
Ⓞ 756779	1600K16	2 Pint Kit	2 lbs	\$33.99
Ⓞ	1600K20	2 Quart Kit	3 lbs	55.99

### BOATLIFE "GIT"™ ROT

• Unique two-part liquid epoxy saturates and restores original strength to wood by penetrating the rot  
• Cures into a tough, resilient adhesive that bonds wood fibers

Item	Model	Size	Ship	Net
Ⓞ 756913	1063	4 oz.	1 lbs	\$16.99
Ⓞ	1064	Pint	1 lbs	34.99
Ⓞ	1065	Quart	4 lbs	56.99

### MAS PENETRATING EPOXY SEALER

This sealer is a low-viscosity epoxy formulation that penetrates deep into rotten or damaged wood, restoring structure and providing a solid base for additional repairs. The penetrating power of this epoxy resin can be dramatically improved by diluting it with common paint solvents such as denatured alcohol, lacquer thinner or acetone. The mixed epoxy and hardener may be diluted with as much as an equal volume of solvent. This simple solution doubles the penetrating power of the MAS penetrating Epoxy Sealer.

**Finish:** Full cure in 4 days at 75°

Item	Model	Size	Ship	M.A.P.
Ⓞ 756790	30-210	1.5 pint (1 pint epoxy / .5 pint hardener)	2 lbs	\$39.99
Ⓞ	30-220	1.5 quart (1 quart epoxy / .5 quart hardener)	4 lbs	69.99

**3M TACK RAG** Use prior to work to wipe off dust, dirt, sanding particles and lint.

Item	Size	Ship	Net
751354	(1) 17" x 36" rag	1 lbs	\$1.89



## Wood Treatments

### PETTIT SEAGOLD FINISH MARINE WOOD TREATMENT

• Translucent Wood, won't hide wood grain • UV stable resins and UV inhibitors, won't turn Brown or Orange • Quick dry; apply 3 to 4 coats per day • No smell, no mess, only a trace of VOCs

Item	Model	Finish	Size	Ship	Net
756751	2045	Satin	Quart	3 lbs	\$33.99
756937	2040	Gloss	Quart	5 lbs	36.99

### PETTIT Z-SPAR® CAPTAIN'S SATIN SHEEN VARNISH

• Provides a pale, durable, long-lasting polyurethane coat  
• Interior use only • Water and alcohol resistant • Amber color

Item	Model	Size	Ship	Net
Ⓞ 756242	V-975	Quart	3 lbs	\$33.99

### PETTIT Z-SPAR CAPTAIN'S ULTRA-CLEAR VARNISH

• Premium urethane varnish • UV inhibitors  
• Outstanding gloss • Resistance against scratching and chipping  
• Easy to apply by brush • Excellent leveling capabilities  
• Durable finish

Item	Model	Size	Ship	Net
Ⓞ 756243	2067	Quart	2 lbs	\$42.99

### PETTIT Z-SPAR CAPTAIN'S VARNISH

• Interior or exterior • A high-solids varnish with UV shield  
• Recommended for the highest quality work • Light amber hue does not discolor wood

Item	Model	Size	Ship	Net
Ⓞ 756920	1015	Pint	2 lbs	\$22.99
Ⓞ	1015	Quart	3 lbs	31.99
Ⓞ	1015	Gallon	9 lbs	99.99

### PETTIT Z-SPAR FLAGSHIP VARNISH

• Interior or exterior • Highest build and film depth per coat  
• Blend of phenolic and alkyd resin with tung and linseed oil  
• Highest UV protection available • Recommended for the highest quality work

Item	Model	Size	Ship	Net
Ⓞ 756921	2015	Quart	3 lbs	\$37.99
Ⓞ	2015	Gallon	9 lbs	106.99

### PETTIT EASYPOXY HI-BUILD VARNISH

• Highest build and film depth per coat • Phenolic resin combined with tung and linseed oils increase depth of gloss with each coat • UV light filter combines with a hindered amine light stabilizer to screen the sun's damaging rays • A good varnish for building up multiple coats quickly

Item	Model	Size	Ship	Net
Ⓞ 753636	2056	Quart	3 lbs	\$33.99

### PETTIT EZ WOOD SEALER

• Seals open wood grain providing a more uniform finish  
• For all woods including teak, mahogany, oak, fir and plywood

Item	Model	Size	Ship	Net
Ⓞ 756922	2018	Quart	3 lbs	\$29.99

### BRISTOL FINISH TRADITIONAL URETHANE

A high-performance urethane varnish designed as a low maintenance alternative to traditional spar varnish. Recoat less often without sacrificing appearance. Spray or brush application and ability to coat multiple times in a day.

**Please Specify:** Quart or Gallon

Item	Finish	Ship	Quart	Ship	Gallon
Ⓞ 756876	Amber	2 lbs	57.99	5 lbs	\$173.99
Ⓞ 756895	Clear	2 lbs	57.99		

Item	Description	Ship	Net
Ⓞ 756877	8 oz. Satin Additive	1 lbs	12.99
Ⓞ 756878	32 oz. Thinner	3 lbs	22.99

### TEAK DECKING SYSTEM SEALER & PROTECTOR

• Water-based, polymer infused liquid • Does not affect teak's non-slip properties • Prevents oxidation for months • Easy to apply and to re-coat • Helps to prevent mold • Safe for the environment • Will not damage deck caulking • Lasts up to 3 months in tropical climates • Prevents dirt from penetrating wood grain • Contains no oils, urethanes, or varnish • Will not get sticky and track dirt and residue

Item	Model	Size	Finish	Ship	Net
Ⓞ 756854	SEALERIQ	Quart	Gloss	3 lbs	\$39.99
Ⓞ	SEALERIG	Gallon	Gloss	9 lbs	131.99

### SEMCO TEAK SEALER

• Waterproofs and protects against surface erosion that leads to discoloration, roughness and checking • Quick drying • Eliminates need for deep cleaning • Single recoating at seasonal intervals maintains appearance and surface integrity of teak

**Please specify:** Clear, Gold or Natural finish

Item	Size	Ship	Net
753933	Quart	2 lbs	\$31.99



## Teak Care

### TEAK WONDER® DRESSING & SEALER

A safe and durable, non-oil based product. Provides a pleasant golden color without darkening the teak or producing that fake look.  
 • Seals the wood, blocking the penetration of dust and dirt • Protects the natural teak oils against UV rays • Inhibits liquids from penetrating into the wood • Will not make teak glossy or slippery • Will not build up an accumulation on the surface • Quick-drying and has no odor  
 • Coverage: 55-65 sq. ft per liter • Perfect for teak decks

Item	Size	Ship	Net
756912	.5 Liter	1 lbs	\$19.99
	1 Liter	2 lbs	25.99
	4 Liter	8 lbs	79.99



### TEAK WONDER® CLEANER

• Cleans easily, without sanding • Brush on and rinse off  
 • Non-caustic, won't damage seals, paint or hardware  
 • Coverage: approx. 65-85 sq ft per liter • Great for teak decks!

Item	Size	Ship	Net
756208	4 Liter	9 lbs	\$42.99



### TEAK WONDER BRIGHTENER

• Lightening process used to eliminate shading from teak wood  
 • Coverage: approx. 85-100 sq ft • Great for teak decks  
 • Finish off with Teak Wonder Dressing & Sealer (page 215)

Item	Size	Ship	Net
756209	4 Liter	10 lbs	\$42.99

### TEAK WONDER COMBO PACK

• Equipped with a cap/pourer that allows easy use of the products  
 • Pack includes (1) bottle of cleaner (1) bottle of brightener  
 • Coverage is approximately 85 - 100 square feet per liter (Depending on the condition of the wood)  
 • Great for teak decks  
 • Finish off with Teak Wonder Dressing & Sealer

Item	Size	Ship	Net
756801	1 Liter cleaner/1 Liter brightener	5 lbs	\$27.99
	4 Liter cleaner/4 Liter brightener	19 lbs	79.99



### TEAKDECKING SYSTEMS® ECO TEAK CLEANER

#### Meets the Clean Marina Program!

• 100% Environmentally safe: non-toxic • Cleans and brightens  
 • Tough on dirt, gentle on teak • Removes mold and mildew  
 • No acid, caustic sodas or phosphates

#### ECO 100 Teak Cleaner Powder\* Dilute with Water

Item	Size	Ship	Net
756802	2 lbs	3 lbs	\$19.99

\* 4 oz. of powder makes 1 gallon.

#### ECO 300 Teak Cleaner Liquid Ready-to-use!

Item	Size	Ship	Net
756803	1 Quart	3 lbs	\$19.99
	1 Gallon	9 lbs	54.99



### TE-KA™ TEAK CLEANER BY MARINE TEX®

• Scrubless 2-part teak cleaner and brightener  
 • Cleans in a fraction of the time of conventional cleaners  
 • Dissolves and removes rust, fuel, oil, blood, grease and old sealers  
 • Restores original golden color

Item	Size	Ship	Net
756791	(2) Pint Kit	3 lbs	\$26.99
	(2) Quart Kit	5 lbs	37.99
	(2) Gallon Kit	20 lbs	85.99



### SEMCO TEAK CLEANER

• 2-Part cleaner and brightener  
 • Part 1 dissolves dirt and sealers  
 • Part 2 brightens and neutralizes Part 1  
 • Deep cleans teak without harsh scrubbing to remove graying, fish blood, fuel stains and teak oils

Item	Size	Ship	Net
753934	Each Part 1 Liter	4 lbs	\$24.99



### MDR AMAZON'S TEAK PREP

• Used by the pros to remove hidden moisture from below the teak's surface  
 • Easy to apply

Item	Size	Ship	Net
750947	32 oz.	2 lbs	\$19.99



### MDR AMAZON'S QUICKI II 2-PART TEAK CLEANER - ACID FREE FORMULA IS BIODEGRADABLE!

• Won't harm fiberglass or eat away wood's soft grain  
 • Part One takes care of the deeper stains, grease and grime  
 • Part Two follows with surface cleaning and brightening agents  
 • Kit includes a teak scrubber for easier teak cleaning

Item	Size	Ship	Net
755638	(2) 32 oz.	6 lbs	\$25.99



### MDR AMAZON'S ONE-STEP TEAK CLEANER

• Environmentally friendly • Acid free formula  
 • Removes dirt, grease and grime  
 • Leaves surface smoother, enhancing the natural texture of the wood  
 • Wipe on, agitate, let it sit 5 minutes and rinse off

Item	Size	Ship	Net
755643	32 oz.	2 lbs	\$12.99



### MDR AMAZON'S GOLDEN TEAK OIL

• Preserves and beautifies teak to a warm golden color  
 • Surrounds wood fibers below the surface to lock out moisture  
 • Non-flammable, biodegradable and easy to apply

Item	Size	Ship	Net
754955	32 oz.	2 lbs	\$16.99



### MDR AMAZON'S LEMON OIL

• The natural cleaning properties of lemon oil with the finest preserving oils, will enhance the luster of fine wood furniture, galley cabinets, paneling, etc.  
 • Treat your wood to a 100% blend of natural oils without perfumes, spirits or waxes  
 • Easy wipe-on application

Item	Size	Ship	Net
755639	16 oz.	1 lbs	\$12.99



### STAR BRITE SEA SAFE TEAK OIL

• Penetrates Deep into Teak for Ultimate UV and Weather Protection  
 • Enhances Natural Wood Grain and Color of Teak and all Fine Woods  
 • Environmentally Friendly, Biodegradable Formula

Item	Model	Size	Ship	Net
755630	89751	32 oz.	2 lbs	\$21.99



### STAR BRITE® GEL FORMULA TEAK CLEANER / RESTORER

• Gel formula clings to vertical surfaces  
 • Restores weathered teak

Item	Size	Ship	Net
753274	32 oz.	2 lbs	\$14.99



### STAR BRITE PREMIUM TEAK CLEANER

• The first step in the restoration of gray, weathered teak  
 • Easy and safe to use  
 • Removes stains and weathering  
 • Will not harm fiberglass or painted surfaces

Item	Size	Ship	Net
756811	32 oz.	3 lbs	\$14.99
	Gallon	9 lbs	39.99



### STAR BRITE PREMIUM TEAK BRIGHTENER

• The second step in the restoration of gray, weathered teak  
 • Brightens teak without hard rubbing or scrubbing  
 • Highlights wood's natural grain and enhances color

Item	Size	Ship	Net
756812	16 oz.	2 lbs	\$11.99
	32 oz.	3 lbs	14.99



### STAR BRITE PREMIUM GOLDEN TEAK OIL

• Fast drying and easy to use  
 • Natural oils with high molecular weight polymers stand up to weathering  
 • UV additives provide protection from damaging exposure

Item	Size	Ship	Net
756813	16 oz.	8 lbs	\$14.99
	32 oz.	3 lbs	23.99
	Gallon	8 lbs	59.99



### STAR BRITE PREMIUM TEAK CARE KIT

Includes 1 quart each of:

- Teak Cleaner (item 751013)
- Teak Brightener (item 751017)
- Traditional Teak Oil (item 751021)

Item	Size	Ship	Net
751023	(3) 32 oz.	8 lbs	\$46.99



### MDR AMAZON'S® STRIP AWAY™

• Water-based: Contains NO METHYLENE CHLORIDE or MEK  
 • Will not damage wood's surface  
 • Lifts multiple layers of paint, varnish or other coatings from teak, mahogany and other wood

Item	Size	Ship	Net
751409	32 oz.	3 lbs	\$26.99





# Awlgrip Systems



We can Special Order most Awlgrip products. Call us with the Awlgrip model number for your low price!



## 545 Epoxy Primer & Converter

545 is a two-component, anti-corrosive epoxy primer for fiberglass, steel, aluminum and wood. Also used to seal filler primers and fairing before topcoat, it may be applied by brush, roller or spray. Use above or below waterline.

Item	Model	Description	Size	Ship	Net
Ⓞ 751369	D8001	White Primer Base	Quart	4 lbs	\$45.99
Ⓞ 751370	D8001	White Primer Base	Gallon	14 lbs	119.99
Ⓞ 990054	D1001	Gray Primer Base	Quart	4 lbs	45.99
Ⓞ 753740	D1001	Gray Primer Base	Gallon	13 lbs	119.99

### AWLGRIP CONVERTER FOR 545 EPOXY 2-PART PRIMER SYSTEM

This is 1-part of a 2-part system used with Gray or White primer base.

Ⓞ 751372	D3001	Converter (required)	Quart	3 lbs	\$41.99
Ⓞ 751371	D3001	Converter (required)	Gallon	9 lbs	113.99



## Awlgrip High Build Epoxy Primer & Converter

Awlgrip is a two component epoxy primer where high build and filling is required. Not to be used below the waterline. Best when used as a surfacer over other Awlgrip primers and fairing compounds. High Build primer may be applied directly to properly prepared wood or fiberglass; however, best results

are obtained when these surfaces are first sealed with 545 Primer. Conventional or airless spray only. Pressure feed equipment is required.

**PRIMER BASE** Color: Off White

Ⓞ Item 750734	D8002	Quart	Ship 5 lbs	Net \$45.99
---------------	-------	-------	------------	-------------

Awlgrip D3002 high build epoxy primer converter is a two component epoxy primer for use where high build and filling is required. Not to be used below the waterline.

### CONVERTER

Ⓞ Item 750694	D3002	Quart	Ship 5 lbs	Net \$47.99
---------------	-------	-------	------------	-------------



## Epoxy Primer Reducer SPRAY APPLICATIONS

T0006 is a standard slow evaporating epoxy reducer for spray application of 545 Primer, Awl-Quik, sprayable fairing compound and high build epoxy primer and is also recommended for Hullgard Epoxy Primer.

Item	Model	Size	Ship	Net
Ⓞ 756914	T0006	Quart	3 lbs	\$24.99
Ⓞ	T0006	Gallon	9 lbs	61.99



## Awlgrip Brushing Reducer BRUSH APPLICATIONS

Awlgrip Topcoat brushing reducer can only be used with 545 Epoxy Primers, AWL-QUIK and AWLGRIP when applying by brush or roller.

Item	Model	Size	Ship	Net
Ⓞ 756915	T0031	Quart	3 lbs	\$29.99
Ⓞ	T0031	Gallon	9 lbs	80.99



## Standard Reducer SPRAY TOPCOAT APPLICATIONS

Use T0003 in Awlgrip / Awlcraft 2000 topcoats when application and cure temperatures are between 70°F to 90°F (21°C to 32°C). T0003 will keep the paint film open but evaporates fast enough to provide adequate dry and dust-free times.

Item	Model	Size	Ship	Net
Ⓞ 756916	T0003	Quart	3 lbs	\$24.99
Ⓞ	T0003	Gallon	9 lbs	66.99



## Fast Evaporating Reducer for Topcoats

Use T0001 in Awlgrip and Awlcraft 2000 Topcoats when application and cure temperatures are between 60°F to 75°F. At 60°F to 75°F. T0001 will keep the paint film open for good flow but evaporate fast enough to provide adequate dry and dust-free times. At higher temperatures, the solvency of T0001 helps maximize atomization. Its fast evaporation rate allows the solvent to exit the film before skinning occurs, avoiding solvent entrapment or solvent "pop." T0001 is also recommended for use in Quik-Grip Primer. Awlgrip reducers are chosen according to spray or brush application and anticipated temperature.

Item	Model	Size	Ship	Net
Ⓞ 756917	T0001	Quart	3 lbs	\$24.99
Ⓞ	T0001	Gallon	9 lbs	66.99



## Cold Cure Accelerator

Cold Cure Accelerator for 545 Epoxy Primer reduces cure and recoat times by as much as 50%. Use Awlgrip M3066 accelerator when using Awlgrip 545 Epoxy Primer to speed up cure rate in cooler temperatures.

Item	Model	Size	Ship	Net
Ⓞ 755416	M3066	Pint	2 lbs	\$29.99



## Awlgrip Topcoats

Create the ultimate impression with Awlgrip topcoats for long-lasting gloss, color retention and chemical resistance. Paint system procedures must be followed. See www.awlgrip.com for details. Recommended for experienced/professional users.

For more information contact: Awlgrip, 888-355-3090 or visit www.awlgrip.com. Call Defender with the model number to find out our low selling price.



## Awlbrite Clear System

- High build, three component, acrylic urethane clear wood finish
- Awlbrite Clear provides a far more durable finish than varnish alone

Item	Model	Description	Size	Ship	Net
Ⓞ 756733	J3005	Gloss base	Quart	2 lbs	\$76.99
Ⓞ 756734	J3006	Plus converter	Pint	1 lbs	66.99
Ⓞ 756735	A0031	Brushing activator/reducer	Pint	1 lbs	29.99



## Topcoat Converter

### AWL-CAT #2 CONVERTER

Converter for spray topcoat applications. Ratio is 1 base - 1 converter.

Item	Model	Size	Ship	Net
Ⓞ 754243	G3010	Quart	3 lbs	\$76.99
Ⓞ 753747	G3010	Gallon	10 lbs	219.99

### AWL-CAT #3 CONVERTER

Converter for brush topcoat applications. Ratio is 2 base - 1 converter.

Item	Model	Size	Ship	Net
Ⓞ 750939	H3002	Pint	2 lbs	\$66.99
Ⓞ 750938	H3002	1/2 Gallon	6 lbs	184.99

## Griptex Non-Skid Additive

To be used with Awlgrip and Awlcraft 2000 topcoat boat paints to give a non-skid texture for deck and step areas. Anti-slip and non-skid additives are mixed directly with topcoats or added to a "tacky" paint surface. Coarse texture.

Ⓞ Item 750937	73013	Quart	Ship 2 lbs	Net \$45.99
---------------	-------	-------	------------	-------------



## Awlprep Wipe Down Solvent

Use Awlprep Surface Cleaner to wipe down final primed or topcoated surfaces before and after sanding.

- Has a "drying" effect which removes latent moisture which can cause a gloss finish to come out flat from the surface
- A surface cleaner for finish primers and topcoats

Ⓞ Item 990053	T0008	Gallon	Ship 8 lbs	Net \$49.99
---------------	-------	--------	------------	-------------



## Awlwash

Free-rinsing, 100% biodegradable wash down concentrate formulated to clean Awlgrip and Awlcraft 2000 topcoats. Does not contain alkalis, acids or abrasives. Will not degrade Awlcare. Works well on all painted surfaces.

Item	Model	Size	Ship	Net
Ⓞ 756660	73234	Quart	3 lbs	\$23.99
Ⓞ	73234	Gallon	10 lbs	55.99



## Awlcare

Hand-applied protective polymer sealer formulated to clean and protect Awlgrip and Awlcraft 2000 topcoats. Removes mild stains and diesel soot; lasts through multiple washings and will not scratch painted surfaces.

Item	Model	Size	Ship	Net
Ⓞ 756782	73240	Pint	2 lbs	\$23.99
Ⓞ	73240	1/2 Gallon	5 lbs	61.99



## Awlspar Varnish

Awlspar® Classic Spar Varnish is a traditional phenolic, tung oil varnish modified with UV inhibitors and absorbers. Specifically designed for exposure to harsh elements. High-gloss finish with superior durability.

Item	Model	Description	Size	Ship	Net
Ⓞ 755419	M3131	Varnish	Quart	3 lbs	\$41.99
Ⓞ 755420	T0016	Awlspar brushing reducer	Quart	2 lbs	24.99

## Premium Tack Rags

Tack rags are commonly used just before painting. They will remove the light dust and dirt from what looks like a clean, ready to paint or varnish surface. Package of 4.

Item 755500	73009	Ship 1 lbs	Net \$7.99
-------------	-------	------------	------------

## Transducer Paints

### MDR Anti-Fouling Transducer Paint

- Water-based cuprous oxide, easy-to-use antifouling paint
- The brush in the cap makes application easy
- Protects transducers from barnacles and marine growth in fresh and salt water
- Color: Black

Ⓞ Item 252077	MDR-720	2 fl. oz.	Ship 1 lbs	Net \$8.99
---------------	---------	-----------	------------	------------

### Aquagard Transducer Paint

- Aquagard® is ideal for use on nylon or bronze transducers
- Aids in improving depthsounder and fishfinder performance
- Simple, easy and effective - simply spray and let dry

Ⓞ Item 751103	72201	6 oz. aerosol	Ship 1 lbs	Net \$15.99
---------------	-------	---------------	------------	-------------

## Brushes and Rollers

### FOAM BRUSH

For varnish and teak oil. Wood peg handle.

Item	Size	Ship	Net
756727	1" - 4"	1 lbs	\$0.49 - 1.09



### CHIP - WHITE CHINA BRISTLE BRUSH

Flat trim for resins, teak oil and bottom paint. Wood handle.

Item	Size	Ship	Net
756726	1" - 4"	1 lbs	\$0.59 - 1.99



### DOUBLE THICK CHIP BRUSH

Flat trim for epoxy, resin and bottom paint. Wood handle.

Item	Size	Ship	Net
756725	1" - 4"	1 lbs	\$0.99 - 2.99



### TRADESMAN POLYESTER PAINT BRUSH

- Chisel trim brush • Lacquered Purple tip handle
- For use with water-based bottom and topside paints

Item	Size	Sash	Ship	Net	Size	Sash	Ship	Net
756736 Please Specify Size & Sash	1"	Angular	1 lbs	\$4.99	2"	Flat	1 lbs	\$7.99
	1"	Flat	1 lbs	4.99	2-1/2"	Angular	1 lbs	8.49
	1-1/2"	Angular	1 lbs	6.99	2-1/2"	Flat	1 lbs	8.49
	1-1/2"	Flat	1 lbs	6.99	3"	Angular	1 lbs	8.99
	2"	Angular	1 lbs	7.99	4"	Flat	1 lbs	8.99



### TRADESMAN WHITE CHINA BRISTLE BRUSH

For smooth oil paint, varnish and stain. Chisel trim for fine working edge.

Item	Size	Ship	Net
756724 Please Specify Size	1"	1 lbs	\$6.99
	2"	1 lbs	7.99
	3"	1 lbs	8.49
	4"	1 lbs	12.99



### WHITE PEARL PRO-LINE WHITE CHINA BRISTLE BRUSH

For solvent-based paints. Natural finish, wood handle and Stainless Steel ferrule.

Item	Size	Sash	Ship	Net
756728 Please Specify Size & Sash	1-1/2"	Flat	1 lbs	\$6.99
	1-1/2"	Angled	1 lbs	7.99
	2"	Flat	1 lbs	7.99
	2"	Angled	1 lbs	8.99
	2-1/2"	Angled	1 lbs	11.99
	3"	Flat	1 lbs	11.99



### THE "BADGER" PROFESSIONAL PRO-LINE WHITE CHINA BRISTLE BRUSH

For urethane, varnish and topside enamel.

Item	Size	Ship	Net
756723 Please Specify Size	1"	1 lbs	\$9.29
	2"	1 lbs	10.99
	3"	1 lbs	17.99



### ECONOMY BOTTOM PAINT BRUSH

Chisel trim. Good for use with bottom paint.

Item	Size	Ship	Net
755397	4"	1 lbs	\$4.29



### MICROFIBER SMOOTH FINISH ROLLERS

Shed resistant woven fabric for all types of paints and stains.

Item	Model	Description	Ship	Net
755315	9MFR2	9" x 1/4" nap	1 lbs	\$3.99
755316	9MFR3	9" x 3/8" nap	1 lbs	3.99



### PRO-LINE LINT FREE FOAM ROLLER FOR SMOOTH FINISHES

For urethane, varnish and enamel. Solvent-resistant phenolic core. Not for use with solvents or 2 part paints.

Item	Size	Multi-Nap Usage	Ship	Net
751738	7"	3/16"-1/4"	1 lbs	\$3.29
751739	9"	3/16"-1/4"	1 lbs	3.29



### MOHAIR RED ROLLER COVER

For enamel paints on smooth surfaces and racing finish bottom paints. Also for gloss enamel, urethane and bottom paint. Color: Red.

Item	Size	Multi-Nap Usage	Ship	Net
754275	7"	1/8"-3/16"	1 lbs	\$3.89
754130	9"	1/8"-3/16"	1 lbs	4.49



### ECONOMY PAINT MATE DYNEX ROLLER COVER

For smooth/semi-smooth surfaces. Baked phenolic core for bottom paint, epoxy, resin and marine coating. 100% polyester.

Item	Size	Pile	Ship	Net
754274	7"	3/8"	1 lbs	\$2.89
754132	9"	3/8"	1 lbs	3.29



### ARROWORTHY GOLDEN EAGLE ROLLER FRAME

4 wire. 1/4" shank. Deluxe plastic threaded handle.

Item	Size	Shank Dia.	Ship	Net
756536	4"	5/16"	1 lbs	\$4.49



### BIRDCAGE ROLLER FRAME

4 wire. 1/4" shank. Deluxe plastic threaded handle.

Item	Size	Dia.	Ship	Net
751740	7"	1-1/2"	1 lbs	2.59
751741	9"	1-1/2"	1 lbs	2.99

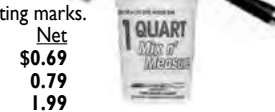

### MIX N' MEASURE CONTAINERS

Plastic with graduating marks.

Item	Size	Ship	Net
756730	1 Pint	1 lbs	\$0.69
	1 Quart	1 lbs	0.79
	5 Quart	1 lbs	1.99



### ARROWORTHY MICROFIBER MINI ROLLER KIT

- Roller length: 4"
- Nap: 4" x 3/8"
- Surfaces: Smooth to semi-smooth
- Includes (1) Barracuda handle, (10) Microfiber covers, (1) Plastic tray

756656 Ship 1 lbs Net \$13.99



### MINI PAINT ROLLER TRAY KIT

Includes: (2) 4" foam roller covers with 3/8" nap, an 11" threaded single rod roller frame, plastic paint tray with drain grooves and one pair of latex gloves.

755249 Model 10880-0 Ship 1 lbs Net \$7.29

### MIGHTY MINI PAINT ROLLERS

- Use with tray handle kit above
- Use fabric rollers for bottom paint
- For oil/alkyd paints

Item	Model	Quantity/Material	Nap	Ship	Net
755250	4FMC-K	(10) Foam, 4"	3/8"	1 lbs	\$9.99
755283	4GL3T/P	(2) Fabric, 4"	3/8"	1 lbs	4.49



### PAINT BRUSH AND ROLLER CLEANER

- Easily spins brush or roller clean and dry
- Heavy duty metal base and handle
- Fits most brushes and rollers

755248 Model 6006 Ship 2 lbs Net \$13.99

### PAINT MIXER FOR BOTTOM PAINT

- Use for mixing all paints and coatings
- Hex shaft eliminates slipping on the drill
- Rust resistant coating
- Fits all drills 3/8" and larger
- Heavy duty construction
- For 1 to 3 gallon cans or pails
- Overall length is 16"

755247 Model M101 Ship 1 lbs Net \$3.99



### ARROWORTHY PLASTIC 4" PAINT ROLLER TRAY

• Accepts 4" wide paint rollers (sold separately)

Item	Model	Ship	Net
756537	4RWT-P	1 lbs	\$1.99

### TRADESMAN PAINT ROLLER TRAY SET

- Standard metal tray with 9" roller and handle
- Perfect for bottom painting
- 1 Qt. capacity

Item	Ship	Net
751742 Tray set	2 lbs	\$5.99
755246 Metal tray only	1 lbs	3.29
754216 Tray liner, plastic	1 lbs	0.89

Tray Liner

## 3M Tape

### SCOTCH-BLUE™ PAINTER'S TAPE FOR MULTI-SURFACES 2090

- Ideal for painting walls and trim, woodwork, glass and metal
- Removes cleanly for up to 14 days Color: Blue

Item	Model	Size	Ship	Net
756819	03680	3/4" x 60 yds.	1 lbs	\$3.99
	09171	1" x 60 yds.	1 lbs	4.99
	09221	1-1/2" x 60 yds.	1 lbs	7.49
	03683	2" x 60 yds.	1 lbs	9.99



### PRECISION MASKING TAPE

- Produces sharp paint lines with both solvent and waterborn paint systems
- Removes easily without tearing or adhesive transfer
- Allows taping over freshly painted surfaces sooner

Item	Model	Size	Ship	Net
756756	06526	3/4" x 60 yds.	1 lbs	\$5.99
	06620	1" x 60 yds.	1 lbs	8.49
	06527	1-1/2" x 60 yds.	1 lbs	11.99



### SCOTCHMARK GREEN MASKING TAPE 256

- Has a smooth, sharp edge
- Doesn't lose its shape when applied to a long horizontal surface

Item	Model	Size	Ship	Net
755290	05423	3/4" x 60 yds.	1 lbs	\$29.99



### SCOTCH BRAND FINE LINE TAPE 218

- Finest color line separation available due to its thinness
- Solvent and moisture resistant
- High adhesion
- Not intended for outdoor use

Item	Model	Size	Ship	Net
751674	04699	3/4" x 60 yds.	1 lbs	\$16.99
751675	04700	1" x 60 yds.	1 lbs	20.99



### PERFORMANCE PLUS DUCT TAPE

Adhesion: Low-medium. Removes cleanly for up to (6) months. Increased light and UV stability means clean removal.

Item	Model	Size	Ship	Net
755830	8979	2" x 60 yds.	2 lbs	\$22.99





## Boat Cover Supports and Tie-Downs

### TAYLOR MADE BOAT COVER SUPPORT SYSTEM

Prevents water from pocketing. Includes 50' of webbing, quick release buckles, boat cover support pole and (2) hooks to attach to the transom.

Item	Model	Ship	Net
101197	55741	3 lbs	\$34.99



### TAYLOR MADE BOAT COVER SUPPORT POLES

All ship 2 lbs Fully Adjustable From 36"-64"



The standard boat cover support pole has a non-marring tip on each end of a telescoping aluminum tube. A durable plastic knob allows for easy adjustment.

Item	Model	Description	Net
753219	11991	Standard-rubber crutch tip on each end	\$25.99
754141	11992	Super-rubber crutch tip ends with a male snap end and grommet pin end	29.99

### TAYLOR MADE BOAT COVER VENT II

Item	Model	Fits	Net
756287	11982	Accommodates 3/4" or 7/8" boat cover support poles	\$18.99



### TAYLOR MADE BOAT COVER SUPPORT ACCESSORIES

Highly recommended to keep your boat cover taut and free from water, snow or debris. Sockets can be mounted on any railing or deck. Wood or fiberglass can be cut to size.

Item	Model	Size	Type	Ship	Net
753245	929	72"	Single wooden bow	1 lbs*	\$12.99
756924	924	72"	Super strong fiberglass bow w/rubber ends	2 lbs*	19.99
926	96"	Super strong fiberglass bow w/rubber ends	2 lbs*	24.99	
753249	935	Die-cast cover bow socket (pair)	1 lbs	6.99	

\*Additional shipping charges may apply.

### DR. SHRINK SUPPORT POLE END CAPS

Item	Model	Description	Ship	Net
752465	DS-BCAP	Fits bottom of wooden 2" x 4" pole end, non-skid	1 lbs	\$4.99
752464	DS-CAP	Fits top of wooden 2" x 4" pole end	1 lbs	4.99



DS-CAP

### KOVER KLAMP

With this one specially designed universal clamp, you can build a frame that is remarkably strong, yet is lightweight and simple to construct. Every boat owner can afford the best protection for his boat.



Item	Model	Description	Ship	Net
753238	K 600	Klamps (5 pack)	3 lbs	\$26.99
756704	STC106	Steel coupling - joins 2 pieces of 3/4" EMT tubing (5 pack)	2 lbs	17.99
753240	SSL 205	Slide lock - prevents Klamp from sliding if vertical or when needed for supports (5 pack)	1 lbs	12.99
753241	RT 305	Rubber tips - attach to bottom to prevent damage (5 pack)	1 lbs	9.99
753242	RP 400	Protector pad - used over Klamps to reduce the wear point on cover (2 pack)	1 lbs	8.49
753243	CCS 500	Color code system - makes reassembly of frame easier with peel-off labels	1 lbs	19.99
753244	EP 700	End plugs - seals ends of tubing to prevent condensation (25 pack)	1 lbs	5.99

### KOVER KLIPS PACK OF 5

Are you tired of watching a strong gust of wind tear through your tarp, ripping out the grommets? Then you are ready for the "Kover Klip." Kover Klip's unique design makes them simple to attach, yet "keep you covered" through the most demanding conditions.

Item	Model	Ship	Net
751010	KK 100	1 lbs	\$6.99

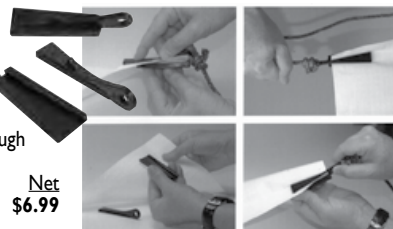

## De-Icers

### OIL FREE D-ICER

- Oil-free design - no chance of oil leaks polluting our environment
- More energy efficient than oil-filled units
- Molded glass filled nylon shroud - guides water and blocks debris
- Stainless steel motor shaft and motor housing
- Dual internal seals and double lip shaft seal
- High efficiency motor and high performance propeller
- Continuous duty single phase motor
- Standard field replaceable power cord
- Designed for harsh saltwater environment with renewable zinc anode for corrosion protection
- Easily installed by one person



Item	Model	HP	Voltage	Power Cord	Ship	Net
000180	6205D	1/2	115	50'	39 lbs	\$515.99
000181	6208D	3/4	115	50'	42 lbs	569.99

## ICE EATER

### TAKES THE BITE OUT OF ICE BUILD-UP

Prevents ice build-up around boats, docks, bulkheads and ponds. Draws warmer subsurface water to the surface to create constant circulation. Will melt existing ice as well: just cut a hole and lower it into place. Motor housing is 16 gauge stainless steel and bronze for corrosion free operation in salt or fresh water. Permanent split capacitor. Average operating depth of 2-3 feet. Three year limited warranty.



### Please Specify:

25', 50', 100', 150' or 200' quick change power cord (200' with 230 Volt AC only)

Please Specify: 115 or 230 Volt AC

Item	Model	Volt	H.P.	Melt Dia.	Mounting Hardware (Included)	Ship	Starting At
003288	P250	115 or 230	1/4	20-25'	(2) 25 ft. x 3/8" lines and shackles	33 lbs	\$549.99
003289	P500	115 or 230	1/2	40'	(2) 25 ft. x 3/8" lines and shackles	33 lbs	589.99
003290	P750	115 or 230	3/4	60'	(2) 25 ft. x 3/8" lines and shackles	43 lbs	609.99
003291	P1000	115 or 230	1	80'	(2) 25 ft. x 3/8" lines and shackles	45 lbs	679.99

### THERMOSTAT

Item	Model	Description	Ship	Net
003124	KT16110	Temperature range: 0-80° F, 115/120 Volt AC	2 lbs	\$82.99

### SCREEN ACCESSORY KITS

Item	Model	Description	Ship	Net
003121	24400	Screen accessory kit for P500	1 lbs	\$19.99
	24500	Screen accessory kit for P750 and P1000	1 lbs	19.99

### REPLACEMENT PARTS

Item	Description	Ship	Net
003120	Propeller for models P500, P750, P1000	1 lbs	\$26.99
012342	Replacement aluminum anode	1 lbs	14.99

Other ICE EATER replacement parts and accessories available by special order.

220 Volt AC models available as special order.

## Storage Covers & Tarps

### BLUE POLY WATERPROOF WINTER STORAGE COVERS

Just about the best lightweight storage cover you can buy. Tough, high density poly woven scrim coated with durable, low-density, UV resistant polyethylene makes the material virtually rip-proof and highly resistant to most chemicals. 5 oz. / sq. yd.



Item	Size	Ship	Net	Item	Size	Ship	Net
101554	8' x 10'	2 lbs	\$3.99	101554	12' x 20'	5 lbs	\$10.99
	8' x 15'	3 lbs	5.99		12' x 22'	4 lbs	12.99
	10' x 12'	3 lbs	6.49		15' x 20'	4 lbs	14.99
	10' x 15'	3 lbs	6.99		15' x 25'	7 lbs	17.99
	10' x 18'	4 lbs	8.99		20' x 30'	10 lbs	29.99
	10' x 22'	5 lbs	9.99		25' x 40'	16 lbs	46.99

### DEFENDER'S FAMOUS "BULLETPROOF" CANVAS TARPULINS

Durable, extra heavy duty Gray water repellent canvas. Will not score-off on boat. Good for direct use or with a frame. Double-stitched, single-twisted yarn. Brass grommets every three feet. 10 oz. / sq. yd. Made in USA. Sample available.



Finished				Finished			
Item	Cut Size	Size	Ship Net	Item	Cut Size	Size	Ship Net
101553	6'x10'	5'8"x9'6"	9 lbs \$52.99	101553	12'x16'	11'6"x15'6"	25 lbs \$154.99
	8'x10'	7'6"x9'6"	10 lbs 67.99		10'x20'	9'6"x19'5"	26 lbs 159.99
	10'x12'	9'6"x11'6"	15 lbs 99.99		12'x20'	11'6"x19'5"	36 lbs 182.99
	10'x15'	9'6"x14'6"	16 lbs 122.99		15'x20'	14'6"x19'5"	37 lbs 224.99

Other rectangular sizes available by special order. Call 800-628-8225 for quote.

## Anti-Freeze Products

### -50° ANTI-FREEZE POTABLE WATER

Provides excellent cold weather and corrosion protection for drinking water systems. Also prevents corrosion of aluminum, copper, brass and solder but will not harm rubber, seals or hose materials. Contains no alcohol. Formulated for use in potable water systems.

Item **756692** Ship 9 lbs **Net \$4.29/Gallon**

### -50° ANTIFREEZE POTABLE WATER & ENGINES SYSTEMS

Protects water systems and engines from freeze-up during storage. Safe for copper, brass and all types of plastic. Non-toxic, propylene glycol formula.

Item **754577** Ship 9 lbs **Net \$5.29/Gallon**

### -100° ANTIFREEZE POTABLE WATER & ENGINES SYSTEMS

Safe for all engines including aluminum. Non-toxic, propylene glycol formula. Contains corrosion inhibitors to protect all metal engine components and seals. Protects your marine engine from freeze-up damage during winter storage.

Item **754578** Ship 10 lbs **Net \$11.99/Gallon**

### BAN FROST 2000 ANTIFREEZE

Provides low toxicity and biodegradable protection for both salt and freshwater cooled engine blocks and heads. Freeze protection to -100° F when used in its undiluted form.

Item **751358** Ship 9 lbs **Net \$16.99/Gallon**

Note: Not for use in potable water systems.

CALL OR CHECK WWW.DEFENDER.COM FOR SPECIAL FALL PRICING ON ANTIFREEZE

## Camo Winterizing Tools

### WINTERIZING KIT FOR STERN DRIVES & OUTBOARDS

This kit uses your existing flusher and a garden hose to winterize your engine. Includes a 5 gallon jug, hose fittings and instructions for winterizing. You supply 5 gallons of anti-freeze for each engine. Reusable.

Item **751359** Ship 4 lbs **Net \$43.99**

### PERMANENT MARINE HEATER BY-PASS KIT

- Allows water heater to be by-passed when winterizing
- Crimp-resistant nylon reinforced hose

Item **752366** Model **35983** Ship 1 lbs **Net \$23.99**

### HAND PUMP WATER SYSTEM WINTERIZING KIT

Allows you to pump antifreeze directly into your boat's water lines and supply tanks through an on-board faucet or a municipal water inlet. Includes hand pump, flexible hose and city water connection.

Item **754222** Model **36003** Ship 1 lbs **Net \$19.99**

### SEASONAL WATER HEATER BY-PASS KIT

- By-pass water heater instead of filling it with antifreeze when winterizing (1/2" fittings)

Item **754215** Model **35713** Ship 1 lbs **Net \$6.99**

### BLOW-OUT PLUGS

- GHT (garden hose thread)
- Use compressed air to clear water lines

Item **755571** Model **36103** Description Plastic Ship 1 lbs **Net \$2.79**  
 Item **755570** Model **36153** Description Brass Ship 1 lbs **Net 5.29**

## Shrink Wrap Vents

### WEATHERTIGHT SELF-ADHESIVE SHRINK WRAP VENT

- Rectangular weathertight self-adhesive shrink wrap vent
- Waterproof vent allows airflow under shrink wrap cover to reduce moisture buildup
- Removable top for easy installation
- Color: Black

Item **100877** Model **DS-683** Dimensions 4" x 5" Ship 1 lbs **Net \$3.99**

### SEAFARER SHRINK WRAP STICK-ON VENT

- Sticks to plastic, wood, synthetics, metal and painted surfaces
- Maintains a strong bond in all weather/wind conditions
- Lightweight, durable, all plastic construction

Item **101062** Model **BSV1** Dimensions 1-1/4" x 4" D Ship 1 lbs **Net \$3.99**

### AIRLETTE STEALTH PUSH-IN VENT

- Automatically cuts its own ventilation hole upon installation
- Lightweight, durable, all plastic construction

Item **100876** Model **BSP1** Dimensions 8" x 4-3/4" Ship 1 lbs **Net \$3.99**



## Brownell Shoring Stands

American-Made Quality... unlike the others

Constructed of steel tubing; fully adjustable and extraordinarily strong. **STACKABLE MOTOR BOAT STANDS** Available in Flat swivel top only.

Item	Model	Height	Ship	Net
<b>753255</b>	<b>MB-4</b>	18"-25"	21 lbs	<b>\$107.99</b>
<b>753254</b>	<b>MB-3</b>	25"-38"	49 lbs	<b>114.99</b>
<b>753253</b>	<b>MB-2</b>	29"-46"	58 lbs	<b>124.99</b>
<b>753252</b>	<b>MB-1</b>	33"-50"	69 lbs	<b>131.99</b>
<b>753251</b>	<b>MB-0</b>	41"-58"	77 lbs	<b>147.99</b>

### NESTABLE SAILBOAT STANDS

Available in V-top or Flat Swivel; please specify when ordering.

Item	Model	Height	Ship	Net
<b>753262</b>	<b>SB-4</b>	24"-36"	78 lbs	<b>\$121.99</b>
<b>753261</b>	<b>SB-3</b>	35"-52"	39 lbs	<b>140.99</b>
<b>753260</b>	<b>SB-2</b>	45"-65"	46 lbs	<b>159.99</b>
<b>753259</b>	<b>SB-1</b>	64"-79"	54 lbs	<b>171.99</b>
<b>753258</b>	<b>SB-0</b>	79"-96"	62 lbs	<b>186.99</b>

### V-TOP OR FLAT SWIVEL TOP

Supplied with above stands. Additional tops available.

Item	Size	Color	Ship	Net
<b>753263FLATTOP</b>	16"H	Blue	13 lbs	<b>\$69.99</b>
<b>753263VEETOP</b>	16"H	Blue	11 lbs	<b>69.99</b>
<b>753264FLATTOP</b>	23"H	Gray	16 lbs	<b>73.99</b>
<b>753264VEETOP</b>	23"H	Gray	14 lbs	<b>73.99</b>
<b>753265FLATTOP</b>	27"H	Orange	18 lbs	<b>75.99</b>
<b>753265VEETOP</b>	27"H	Orange	18 lbs	<b>75.99</b>

### KEEL STANDS

Domestic steel. Easily adjustable Acme threaded tops. Use one keel stand for each 10,000 pounds of vessel weight.

Item	Size	Ship	Net
<b>753272</b>	Adjusts from 16"-24"	22 lbs	<b>\$102.99</b>

## Shrink Wrap Supplies



**SHRINK FILM** High quality 7 mil film. Color: White. Choose from dimensions below.

Item	Weight	Dimensions W x L	Ship	Net
<b>101220</b>	60 lbs	17' x 106', 20' x 89', 24' x 75', 28' x 64', 32' x 56'	65 lbs	<b>\$154.99</b>
<b>101065</b>	100 lbs	16' x 200', 20' x 160', 24' x 120, 28' x 114', 32' x 100'	105 lbs	<b>249.99</b>
<b>101070</b>	135 lbs	40' x 100'	138 lbs	<b>299.99</b>
<b>100223</b>	200 lbs	14' x 425', 16' x 372', 20' x 298', 24' x 248', 28' x 213', 32' x 186', 40' x 149'	205 lbs	<b>424.99</b>

**SEAFARER SHRINK WRAP TAPE** High quality. Color: White.

Item	Size	Ship	Net
<b>100217</b>	2" x 180'	2 lbs	<b>\$13.99</b>
<b>100218</b>	4" x 180'	3 lbs	<b>21.99</b>
<b>100219</b>	6" x 180'	4 lbs	<b>31.99</b>

### ACCESSORIES

Item	Description	Ship	Net
<b>100230</b>	Tension tool	4 lbs	<b>\$77.99</b>
<b>100868</b>	Preservation sealing tape, 3" x 108'	2 lbs	<b>21.99</b>
<b>100996</b>	Strapping: 3/4" x 1000'	7 lbs	<b>49.99</b>
<b>100231</b>	Strapping: 1/2" x 1500'	7 lbs	<b>39.99</b>
<b>100233</b>	Plastic trim knife	1 lbs	<b>6.99</b>
<b>100234</b>	Buckles: 1/2" 100 pk.	2 lbs	<b>10.99</b>
<b>100227</b>	Access door: 30"W x 36"H, Clear or White	1 lbs	<b>13.99</b>
<b>754228</b>	Large access door: 36"W x 72"H, Clear or White	2 lbs	<b>14.99</b>

### 3M PRESERVATION TAPE

A White, pressure-sensitive tape designed for use in sealing of plastic sheeting, tarps and shrinkwrap. Applies well in cold weather and is resistant to hot and cold temperatures. Removes easily up to 2 years after application. 3" x 36 yards.

Item **751609** Model **62335** Ship 2 lbs **Net \$72.99**

### SHRINK WRAP HEAT GUN KIT WITH CARRY CASE

Shrinkfast 998 UL heat gun kit with carry case, auto igniter, regulator, 25' propane hose and UL guard.

Item **751717** Model **998** BTU's 212,000 Ship 20 lbs **Net \$609.99**

### 6' Heat gun extension for Model 998

Item **756342** Model **198100** Ship 13 lbs **Net \$389.99**

### DR. SHRINK RAPID SHRINK RS100 HEAT GUN TOOL KIT

Propane fired. Kit: Shrink wrap heat gun, 25' propane hose, regulator, shrink wrap training DVD, safety glasses, long cuff shrink wrap safety gloves and plastic case.

Item **755967** Model **RS100** BTU's 100,000 Ship 12 lbs **Net \$329.99**

### 3' Heat gun extension for RS70 and RS100

Item **754302** Model **DS-RS-EXT** Ship 3 lbs **Net \$69.99**





## Roca/Imtra Wiper Arms

### ROCA PENDULUM & PANTOGRAPH WIPER ARMS

- Powder-coated 304 Stainless Steel
- Heavy duty Stainless Steel spring
- All fit as replacements on most competitive motors

#### Pendulum Wiper Arms

Item	Model	Description	Application	Ship	Net
305892	520100	11"-14" Pendulum	W5 Motor	1 lbs	\$23.99
	539617	12.6"-18" Pendulum	Roca W10/W12 series	1 lbs	34.99
	539624	18.7"-24" Pendulum	Roca W10/W12 series	1 lbs	36.99

#### With adjustable tip - Please specify 13"-18" or 18"-24"

304833	539218	13"-18"	Roca W10/W12 series	1 lbs	\$49.99
	539224	18"-24"	Roca W10/W12 series	1 lbs	49.99

#### Pantograph Wiper Arms

Item	Model	Description	Application	Ship	Net
305893	539318	13 - 18" Pantograph	Roca W10/W12 series	2 lbs	\$89.99
	539324	18 - 24" Pantograph	Roca W10/W12 series	2 lbs	94.99

## Roca/Imtra Replacement Blades

### ROCA WIPER BLADES All ship 1 LBS.

- Zinc-plated steel with rubber inserts
- Fits Imtra/Roca Pantograph and Pendulum arms
- Supplied with clips suitable for other wiper arms
- Application: Roca, IMW, AFI / Marinco and Ongaro

Item 305891 Sizes ranging from 11"-22" Starting at \$8.49

### ROCA W SERIES WIPER BLADES All ship 1 LBS.

- Black stainless steel
- This wiper blade is compatible with W25 and W38 wiper systems

Item 551041 Specify size: 22", 24", 28" or 30" Starting at \$29.99

## Roca/Imtra Wiper Controls

### ROCA THREE WIPER CONTROL BOX AND SWITCH

- Offers control of three wipers with a wide range of operational settings
- Smart wash function incorporated into switch
- Compatible with Roca W10 & W12 motors
- Choose a primary wiper or combined synchronized operation (intermittent, slow and high speed settings)



Item	Model	Description	Ship	Net
305904	532113	12/24 VDC Control box, 39" harness	1 lbs	\$284.99

### ELECTRONIC WIPER SWITCH

Stand-alone, compact wiper switch; 12/24 VDC; wiring harness included; controls speeds (low, high and 3 levels of intermittent) and will also engage a washing system. Works with most popular wiper motors. Compatible with Exalto Type I & Type 2 motors and all Roca models including the W38.



Item	Model	Description	Ship	Net
303973	210341	For 1 wiper	1 lbs	\$199.99
303974	210342	For 2 wipers	1 lbs	259.99

## Imtra Washing Components

Complete your wiper system with the ability to clean that salty windshield; don't just smear the salt water around. Systems can operate off of a separate reservoir or through your ship's pressure water system by means of a simple solenoid. Select from a host of bulkhead connectors, fittings, tubing and more.



Item	Model	Description	Ship	Net
300268	SV1/4-12V	Solenoid valve, 1/4", 12 VDC	1 lbs	\$109.99
300269	312-1035	Reservoir (4L) with pump, 12 VDC	2 lbs	84.99
300270	2186	Thru-bulkhead connector	1 lbs	54.99
550694	2161	Bulkhead mount washing jet	1 lbs	94.99
300272	2129	Elbow fitting	1 lbs	9.99

Item	Model	Description	Ship	Net
300273	2166	Tee fitting	1 lbs	\$10.99
300274	2119	Straight coupling, 1/4"	1 lbs	6.49
300275	2154F	Tubing, Black, 1/4", soft for exterior (per foot)	1 lbs	1.89
300276	2157F	Tubing, Black, 1/4", hard for interior (per foot)	1 lbs	1.29
304005	21000.326	Washing jet	1 lbs	16.99

## Ongaro Wiper Arms & Replacement Blades

### ONGARO STANDARD WIPER MOTOR KIT

- Adjustable to either 80° or 110° sweeps
- Self-park to port or starboard
- Includes a single speed deluxe motor, 11"-14" arm and 11" blade
- Fits the same hole pattern as AFI, TMC and American Bosch



Item	Model	Ship	Net
302147	31011	2 lbs	\$79.99

### ONGARO HEAVY DUTY WIPER MOTOR

- Will power up to 24" arm and 24" blade
- Self-parking with 4 adjustable sweeps 40° - 100°
- 2-speed motor
- Same hole pattern as AFI, TMC and American Bosch

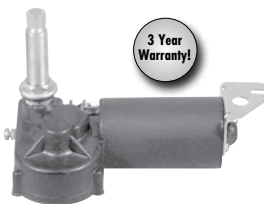

Item	Model	VDC	Shaft	Net	Item	Model	VDC	Shaft	Net
302493	31991	12	1-1/2"	\$89.99	303061	31992	24	1-1/2"	\$99.99
302144	30991	12	2-1/2"	89.99	302495	30992	24	2-1/2"	99.99
302496	32991	12	3-1/2"	99.99	303062	33892	24	3-1/2"	109.99
303016	40400		Rocker switch 3-position 20A					Ships 1 lbs	21.99

### ONGARO DELUXE ADJUSTABLE J-HOOK WIPER ARM

- Powder-coated 304 stainless steel
- Heavy Stainless Steel spring
- Replaces all competitive arms on heavy duty motors



Item	Model	Size	Ship	Net
550829	33650	12"-18"	1 lbs	\$29.99
	33651	19"-24"	1 lbs	29.99

### ONGARO DELUXE ULTRA REPLACEMENT BLADE

- Powder-coated steel with natural rubber
- Replaceable blade inserts (will fit most arms)

Item	Model	Size	Ship	Net	Item	Model	Size	Ship	Net
303128	33011	11"	1 lbs	\$16.99	302991	33018	18"	1 lbs	\$16.99
303129	33012	12"	1 lbs	16.99	302992	33020	20"	1 lbs	17.99
302989	33014	14"	1 lbs	16.99	302993	33022	22"	1 lbs	17.99
302990	33016	16"	1 lbs	16.99					

### ONGARO DELUXE PANTOGRAPH ADJUSTABLE WIPER ARM

Black power-coated stainless steel; HD stainless steel spring; easy to install; replaces most competitive arms; 5/8" shaft

Item	Model	Size	Ship	Net
550704	33671	19" - 24"	2 lbs	\$65.99
	33670	12" - 18"	2 lbs	65.99

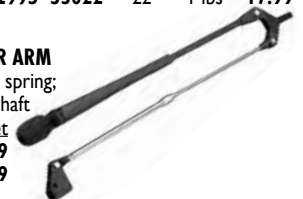



### ChartKit Full Size Paper Chartbooks

22" x 17" spiral bound full-color reproductions of U.S. government and private charts. Companion CDs include "Offshore Navigator Lite" software. Click your mouse to create a waypoint. Click again and a route is created. Distances, bearings and GPS positions are calculated and displayed instantly.



### Embassy Cruising Guides

- Crush-proof spiral bound
- Local expert knowledge
- Restaurant suggestions
- Yacht clubs and repair yards
- Hundreds of color photos
- Suggested courses and Loran/GPS waypoints
- Color NOAA chart segments
- Sightseeing tips
- Marina locations
- Launching ramps
- Detailed navigation advice



#### ChartKit Full-Size

ATLANTIC AND GULF COAST CHARTKITS All ship at 4 lbs			
Item	Model	Area of Coverage	Net
050925	R02-17	Canadian Border to Block Island, RI	\$132.99
805470	R03-17	New York to Nantucket and to Cape May, NJ	132.99
050853	R04-14	Chesapeake and Delaware Bays	132.99
050923	R06-14	Norfolk, VA to Fernandina Beach, Florida & ICW	132.99
805710	R07-16	Florida East Coast and the Keys	132.99
805698	R08-15	Florida West Coast and the Keys	132.99
050792	R16-04	New Orleans to Panama City, FL	132.99

BAHAMAS AND THE VIRGIN ISLANDS CHARTKITS - CD not included			
050787	R09-07	Bahamas to Crooked Island Passage	137.99
050069	R10-7	The Virgin Islands and Puerto Rico	86.99

PACIFIC COAST CHARTKITS			
805697	R12-10	Southern and Central, Ca, S.F to Ensanada	104.99
805667	R15-05	Pacific NW to Northern California	132.99

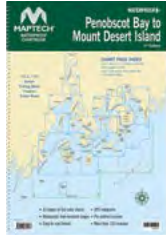

#### Maptech Waterproof Chartbooks & Compact ChartKits

### Waterproof Chartbooks

- Measure: 12" x 17" with durable plastic binding
- Easy-to-use, compact chartbooks
- Printed on quality, waterproof, tear-resistant paper

MAINE, NEW HAMPSHIRE, MASSACHUSETTS AND RHODE ISLAND All Ship 2 lbs			
Item	Model	Area of Coverage	Net
805727	WPB0210-03	Penobscot Bay to Mt. Desert Island, Maine, 3rd Ed	\$54.99
800749	WPB0220-03	Casco Bay to Camden, Maine, 3rd Ed	54.99
805687	WPB0230	Cape Ann to Portland, Maine, 2nd Ed	54.99
050914	WPB0245-01	Cape Cod Canal to Casco Bay, 1st Ed.	54.99
050915	WPB0320-01	Narragansett to Block Island, 1st Ed.	54.99

CONNECTICUT, NEW YORK, AND NEW JERSEY All Ship 2 lbs			
800750	WPB0325-05	Long Island Sound, 5th Ed	54.99
805728	WPB0340-04	South Shore Long Island, 4th Ed	54.99
805689	WPB0350-03	Hudson River, New York Harbor, 3rd Ed	54.99
050793	WPB0360-03	New Jersey Coast, Raritan Bay to Cape May, 3rd Ed	54.99

CHESAPEAKE BAY All Ship 2 lbs			
805720	WPB0430-01	Upper Chesapeake Bay, 1st Ed	72.99
805721	WPB0440-01	Lower Chesapeake Bay, 1st Ed	72.99

#### Richardsons' Waterproof Chartbooks All ship at 2 lbs

Item	Model	Area of Coverage	Net
800658	BB4	Buzzards Bay, South Cape and the Islands, 4th Edition	49.99
800659	LIS4	Long Island Sound, 4th Edition	54.99
800600	KEYS3	Florida Keys and Bimini, 3rd Ed	54.99
050916	TB2	Tampa Bay to Flamingo, 2nd Edition	64.99

#### Richardsons' Great Lakes & Inland Waters

12" x 18" spiral-bound • Includes reproductions of government charts, descriptions of marine facilities, bridge signals, numerous aerial harbor photographs, emergency procedures and an index. Most also include GPS waypoint labels on chart pages.

Item	Model	Description	Ship	Net
050790	HR3	Hudson River and Adjacent Waterways: New York Harbor to Sorel (includes Lake Champlain). St. Lawrence River: Sorel to Cornwall. Erie and Lyons (includes Cayuga and Seneca Lakes), 3rd Ed	3 lbs	\$77.99
800751	LO7	Lake Ontario: Thousand Islands, Bay of Quinte, Welland Canal, St. Lawrence Seaway east to Cornwall, west to Hamilton, 7th Ed	3 lbs	95.99
805703	LE7	Lake Erie: Lake St. Clair, St. Clair River, Niagara River, Welland Canal, northeast to Niagara, northwest to Sarnia, 7th Ed	3 lbs	95.99
050789	LH7	Lake Huron: North Channel, Georgian Bay, west through the straits of Mackinac, south to Sarnia, north to St. Joseph Island, 7th Ed	3 lbs	104.99
800698	LM10	Lake Michigan: Green Bay, Lake Charlevoix and Straits of Mackinac, 10th Ed	2 lbs	77.99
050676	LS4	Lake Superior: Isle Royale, Apostle Islands, Keweenaw Waterway, St. Mary's River, Soo Locks and the De Tour Passage, 4th Ed	3 lbs	86.99
050662	WC	Weatherite chartbook carrier	1 lbs	20.99

#### Embassy Cruising Guides

EMBASSY CRUISING GUIDE All ship at 4 lbs			
Item	Model	Area of Coverage	Net
805476	CGNEC-14	New England Coast, 14th Ed	\$41.99
050924	CGLIS-17	Long Island Sound to Cape May, NJ, 17th Ed Perfect companion to ChartKit 805470 R03-17	41.99
805733	CGCBF-07	Chesapeake Bay to Florida, 7th Ed Perfect companion to ChartKits 050853 R04-14 and 050923 R06-14	41.99
800741	CGFL-07	Florida and the Bahamas, 7th Ed Perfect companion to ChartKits 805710 R07-16 and 805698 R08-15	41.99

#### Maptech Waterproof Charts All ship at 1 lbs

MAINE, NEW HAMPSHIRE, MASSACHUSETTS AND RHODE ISLAND			
805716	WPC019-05	Block Island, RI to Nantucket, MA, 5th Ed	\$22.99
800743	WPC005-06	Cape Cod's South Shore and Buzzards Bay, 6th Ed	22.99
800608	WPC007-05	Boston Harbor Entrance to York, ME, 5th Ed	22.99
805711	WPC018-05	Narragansett Bay, RI, 5th Ed	22.99
800744	WPC020-05	Cape Cod Bay, 5th Ed	22.99
050912	WPC021-07	Massachusetts Bay & Boston Harbor, MA, 7th Ed	22.99
050844	WPC027-03	Portsmouth, Great Bay and Isles of Shoals, 3rd Ed	22.99
804155	WPC036	Cape Ann to Cape Elizabeth, ME, 3rd Ed	22.99
805693	WPC042	Blue Hill Bay to Machias Bay, ME, 2nd Ed	22.99
805713	WPC073-02	Casco Bay, ME, 2nd Ed	22.99
805726	WPC074-03	Penobscot Bay, ME, 3rd Ed	22.99
800697	WPC075-02	Stonington to Mt. Desert Island, 2nd Ed	22.99
805725	WPC076-03	Boothbay Harbor, ME, 3rd Ed	22.99
805724	WPC077-01	Muscongus Bay, ME, 1st Ed	22.99
805717	WPC083-02	Merrimack River and Plum Island Sound, 2nd Ed	22.99
800703	WPC084-03	Marblehead to Cape Ann, MA, 3rd Ed	22.99
805718	WPC085-02	Martha's Vineyard and Nantucket, MA, 2nd Ed	22.99

CONNECTICUT, NEW YORK AND NEW JERSEY			
803333	WPC001	Long Island Sound, 9th Ed	27.99
800701	WPC086-02	Fishers Island to Block Island, 2nd Ed	22.99
805471	WPC006-04	Peconic Bays to Montauk, NY, 4th Ed	22.99
800742	WPC017-03	Watch Hill, RI to New Haven, CT, 3rd Ed	22.99
805474	WPC016-04	Western Long Island Sound, 4th Ed	22.99
805702	WPC003-06	Long Island's South Shore, 6th Ed	22.99
805475	WPC004-07	Hudson River, NYC to Troy Lock, 7th Ed	22.99
804177	WPC048	Champlain Canal, Troy Lock to Lake Champlain, 1st Ed	22.99
050845	WPC049-03	Lake Champlain, 3rd Ed	22.99
800187	WPC008	NY Harbor and Approaches, 5th Ed	22.99
804163	WPC034	Sandy Hook to Atlantic City, NJ, 4th Ed	22.99
800745	WPC035-03	Little Egg Harbor to Cape May, NJ, 3rd Ed	22.99

CHESAPEAKE BAY AND MID-ATLANTIC			
805683	WPC022	The Potomac River, 2nd Ed	22.99
800657	WPC025	Upper Chesapeake Bay, 4th Ed	22.99
805712	WPC026-03	Lower Chesapeake Bay, 3rd Ed	22.99
804186	WPC044	Annapolis to Cambridge, 2nd Ed	22.99
800746	WPC047-03	Delaware Bay and The C&D Canal, 3rd Ed	22.99
805423	WPC080	Annapolis, MD, 1st Ed	22.99
805719	WPC089-03	Albemarle and Pamlico Sounds, NC, 3rd Ed	22.99
805472	WPC099-02	Cape May, NJ to Savannah, GA, 2nd Ed	22.99

FLORIDA EAST COAST AND THE KEYS			
805707	WPC009-05	Upper FL Keys: Miami to Upper Matecumbe, 5th Ed	22.99
805708	WPC010-04	Middle FL Keys: Tavernier to Sugarloaf Key, 4th Ed	22.99
805709	WPC011-04	Lower FL Keys: Summerland to Dry Tortugas, 4th Ed	22.99
805473	WPC012-04	Florida East Coast to Grand Bahama, 4th Ed	22.99
805715	WPC013-03	West Palm Beach to Miami, 3rd Ed	22.99
805684	WPC014	Melbourne to Palm Beach, 2nd Ed	22.99
805691	WPC015-02	St. Augustine to Melbourne, 2nd Ed	22.99
804187	WPC028	Flamingo to Everglades City, 1st Ed	22.99
805722	WPC029-02	Everglades City to Charlotte Harbor, 2nd Ed	22.99
805729	WPC030-04	Tampa Bay to Tarpon Springs, 4th Ed	22.99
804190	WPC031	St. Petersburg Beach to Captiva Pass, 2nd Ed	22.99
805723	WPC032-02	Manasota Key to Ft. Myers Beach, 2nd Ed	22.99



**WEEMS & PLATH ELEGANT NAVIGATION SET**

- Brass one-hand dividers
- Deluxe brass arm parallel rules
- 1-3/4" liquid filled brass compass
- Elegant mahogany finish box with polished brass hardware

Item	Model	Ship	M.A.P.
805378	319	2 lbs	\$164.99



**WEEMS & PLATH ULTRALIGHT DIVIDER/COMPASS**

- Quick acting, strongly made, one-hand dividers
- For circles up to 7.5"
- Interchangeable points and leads included
- Stainless steel points

Item	Model	Size	Ship	M.A.P.
803220	176	7"	1 lbs	\$19.99

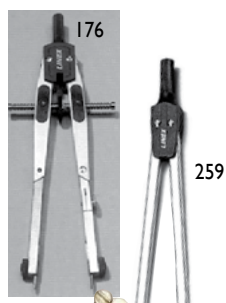

**WEEMS & PLATH FIXED POINT DIVIDERS**

- Matte nickel-plated brass self-centering dividers

Item	Model	Size	Ship	M.A.P.
803221	259	5"	1 lbs	\$16.99



**WEEMS & PLATH ONE-HAND DIVIDERS**

- Brass handles
- Tapered sides & polished stainless steel tips
- Lifetime warranty

Item	Model	Size	Ship	M.A.P.
803216	170	7"	1 lbs	\$32.99



**WEEMS & PLATH PROTRACTOR WITH HANDLE**

- Triangular, precision divided
- 7.75" on short sides
- Crafted with clear vinylite

Item	Model	Ship	M.A.P.
803234	101	1 lbs	\$14.99

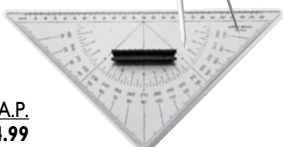

**WEEMS & PLATH COMPUTE-A-COURSE™**

- Features an adjustment for local variation; for instant readings of both true and magnetic courses
- Measures distances, position fixes and solves time/speed/distance problems
- Instructions, cover and practice chart section included

Item	Model	Size	Ship	M.A.P.
803233	111	7-3/16" x 8-1/2"	1 lbs	\$31.99



**WEEMS & PLATH PARALOCK PLOTTER**

- Locking knob enables the 2 rulers to be fixed in any given separation which allows fast determination of GPS position
- 2 sets of holes enable finger tips to act as friction pads
- Opening width is the same as standard rulers

Item	Model	Size	Ship	M.A.P.
800106	90	7-1/4"L	1 lbs	\$26.99

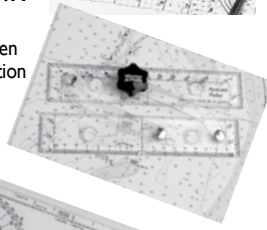

**WEEMS & PLATH PARALLEL PLOTTER**

- Roller mounted plotter contains popular distance/ inch scales and a semi-circular protractor
- Plot easily in restricted spaces

Item	Model	Size	Ship	M.A.P.
803231	120	3" x 12.5"	1 lbs	\$22.99
803219	60	2.7" x 8"	1 lbs	22.99

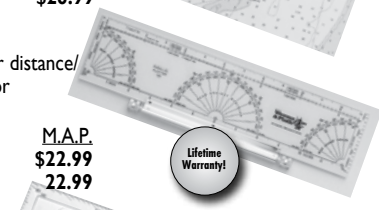

**WEEMS & PLATH PARALLEL RULER**

- Bevels on the long sides
- Smooth motion, cork-discs for sure grip
- Deep seat precision dividing 360°
- Made of crystal-clear acrylic with protractor markings
- Aluminum arms and handles

Item	Model	Size	Ship	M.A.P.
803225	140	12"	1 lbs	\$19.99
803226	141	15"	1 lbs	21.99
803227	138	18"	1 lbs	29.99



**WEEMS & PLATH NAUTICAL SLIDE RULE**

**Time Speed Distance Calculator**

- A solution to all speed-time-distance problems
- Speed in knots or mph; time in hours, minutes or seconds
- Distance in nautical or statute miles (or yards)
- Accurate, easy to read circular pattern
- Standard in U.S. Navy

Item	Model	Size	Ship	Net
800100	105	7-3/8" square	1 lbs	\$22.99



**DAVIS CHARTING KIT**

- Includes one arm protractor, course plotter and protractor triangle
- Also includes the Davis parallel ruler, professional dividers and a pencil
- Conveniently organized in a 5-3/4" x 16-1/4" plastic carrying case, with instructions

Item	Model	Ship	Net
803212	083	1 lbs	\$43.99

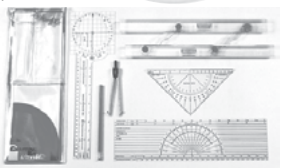

**WEEMS & PLATH LIGHRule™**

- Vessel identification tool shows the actual view of vessels for port, starboard, bow and stern lights
- Identifies 60 light configurations and provides a magnifying lens
- Displays audible signals for restricted visibility, maneuvering and warning
- Made of durable plastic and stored in a vinyl sleeve

Item	Model	Size	Ship	M.A.P.
805408	190	15-3/4" x 5-1/4"	1 lbs	\$29.99



"A Great Gift Idea"  
Practical Sailor

**ROADRULE® USATONS NAVIGATIONAL TOOL**

- Durable two-sided Black PVC
- Identifies the most common U.S. aids to navigation
- Identifies rules of the road and maneuvering
- Identifies warning signals for U.S. waters

Item	Model	Size	Ship	M.A.P.
800094	290	15-3/4" x 5-1/4"	1 lbs	\$29.99

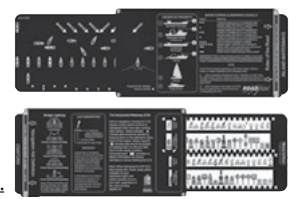

**WEEMS & PLATH PROFESSIONAL MARINER'S NAVIGATION KIT**

- Includes Navitote (made with Tough Duck, which is a PVC backed, polyester duck fabric), Paralock Plotters, Vectormaster, parallel plotter, chart correction template, mechanical pencil, ultralight divider, professional brass pencil compass

Item	Model	Ship	M.A.P.
800510	3250	4 lbs	\$189.99



**WEEMS & PLATH 3" DIAMETER CRYSTAL GLASS MAGNIFIER**

- Optical-grade, crystal glass with compass rose
- 4x magnification
- Packaged in felt-lined gift box

Item	Model	Ship	M.A.P.
800579	515	2 lbs	\$38.99



**WEEMS & PLATH LOG BOOKS**

**The Ship's Log**

- Lined pages for recording ship's data and activities
- Includes guest register, vessel specifications and serial number list pages, as well as quick reference pages on rules of the road, weather reference, radio procedures and more

**The Cruising Log**

- Provides ample space for recording information about your excursions, guest registry and quick reference pages

**The Maintenance Log**

- Ample space to list vessel specifications, spare part numbers, previous repairs and maintenance, etc.
- Also includes quick reference pages

Item	Model	Description	Ship	M.A.P.
803260	797	The Ship's Log	1 lbs	\$24.99
803261	798	The Cruising Log	1 lbs	24.99
803264	804	The Maintenance Log	1 lbs	24.99



**WEEMS & PLATH NAVITOTE**

- Durable 10 oz. khaki colored PVC backed polyester duck fabric with Blue piping, nickel-plated grommets and web handle

Item	Model	Size	Ship	M.A.P.
803232	325	26-1/2" x 22"	2 lbs	\$27.99



**WALKER COMMON SENSE LOG BOOK**

- Tabbed sections for cruising log, vessel info, fuel log, maintenance log, and more (122 pages)

Item	Model	Size	Ship	Net
050721	978-0945265313	7-3/4" x 10"	1 lbs	\$19.99



**DAVIS QUICK REFERENCE NAVIGATIONAL RULES- All ship 1 lbs**

- Color, weatherproof and punched for binder or bulkhead
- 8-1/2" x 11" • Used by U.S.C.G. and U.S. Power Squadrons

Item	Model	U.S. Navigation Rules	Net
803249	125	U.S. Navigation Rules	\$8.99
803250	126	Coastwise Piloting	8.99
803251	127	International Nav Rules	8.99
803255	131	Weather Forecasting	8.99
803256	132	Celestial Navigation	8.99

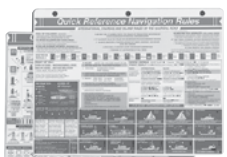

**NAVIGATION RULES & REGULATIONS HANDBOOK**

- Contains - International and Inland rules of the road and their respective annexes, - Bridge-to-bridge radiotelephone, regulations, - Vessel traffic management regulations, - Other pertinent regulations for waterway users. 33 CFR 83.01(g) requires: "The operator of each self-propelled vessel 12 meters or more in length shall carry, on board and maintain for ready reference, a copy of these rules."

Item	Model	Ship	Net
050344	978-1-937196-23-3	1 lbs	\$10.99





**Binoculars**

**NEW!**

**STEINER HERITAGE™ LIFETIME WARRANTY**



**Steiner Bluhorizons Series Binoculars**

- Autobright™ sunlight adaptive lens technology
- Fast-Close-Focus™
- Compact, lightweight design
- Textured armor for a better grip
- Neoprene carry case
- Ergonomic eyecups
- Rainproof IPX4
- Heritage™ Lifetime Warranty

Item	Model	Objective Diameter	Magnification	Field of View at 1000 Yds.	Close Focus Range	Ship	Net
800753	2043	22mm	8x	410'	6.6'	1 lbs	\$189.99
Ⓞ 800752	2044	26mm	10x	321.5'	9.8'	2 lbs	199.99



**Steiner Military / Marine Binoculars**

- Military Binoculars, Adapted for Rugged All-around Use
- Compact, Lightweight, Nearly Indestructible
- Ship 1 lbs

Item	Model	Magnification	Field of View	M.A.P.
800752	2036	8 x 25	360'	\$189.99
	2037	10 x 25	300'	199.99



**Steiner Commander 7x50**

- Field of view 438' @ 1,000 yards
- Submersible to 33'
- 20 mm eye relief
- Includes protective case, lens cover and floating strap
- Steiner heritage lifetime warranty

Item	Model	Ship	M.A.P.
800655	2304 w/o compass	5 lbs	\$1049.99
Ⓞ 800656	2305 w/compass	5 lbs	1299.99



**Steiner Marine 7x50**

- Field of view: 356' @ 1,000 yards
- Waterproof and shockproof
- 20 mm eye relief
- Unique Sport Auto Focus makes the re-focus unnecessary from distance of 20 m to infinity
- Includes web strap, rain and spray guard for the eyepieces and attached objective lens caps

Item	Model	Ship	M.A.P.
805208	575	4 lbs	\$299.99



**Steiner Navigator Pro 7x50**

- Field of view: 370' @ 1,000 yards
- Waterproof up to 16' depth
- Unique Sport Auto Focus makes the re-focus unnecessary from distance of 20 m to infinity
- Has carrying strap, lens covers and bag

Item	Model	Ship	M.A.P.
800677	7655 w/o compass	5 lbs	\$449.99
Ⓞ 800678	7155 w/compass	5 lbs	599.99

**CLICLOC BINOCULAR FLOAT STRAP FOR 7X50**

Item	Model	Ship	Net
800681	7680/3 Yellow	1 lbs	\$44.99



**Nikon A211 Aculon**

- Fully rubber armored and water resistant
- Multi-layer coated optics
- Tripod adaptable
- Quick, easy central focus
- Aspherical eyepiece lens elements
- Turn-and-slide eyecups
- 7x50 - Field of view: 335' @ 1000 yards
- 10x50 - Field of view: 341' @ 1000 yards

Item	Model	Ship	M.A.P.
800615	8247 7x50	3 lbs	\$109.95
800616	8248 10x50	3 lbs	119.95

We sell remanufactured binoculars at great prices. Visit [www.defender.com](http://www.defender.com) for our current selection.



**Nikon OceanPro 7x50**

- Field of view: 377' @ 1,000 yards with compass and 378' @ 1,000 yards non-compass
- Waterproof and fogproof
- 22.7 mm eye relief
- Enhanced resolution and high contrast for low light and bad weather conditions
- Fold-down, supple rubber eye cups
- Has floating neck strap and case
- Center focus • Nitrogen filled

Item	Model	Ship	M.A.P.
805458	16026 w/compass	4 lbs	\$299.95
802869	7440 w/o compass	4 lbs	249.95



**Nikon Action EX™ ATB 7x50**

- Field of view: 335' @ 1,000 yards
- Waterproof and fogproof
- 17.1 mm eye relief
- Turn-and-slide rubber eyecups with detents
- Center focus with a diopter control
- Includes neck strap and case
- Nitrogen filled

Item	Model	Ship	M.A.P.
805336	7239	4 lbs	\$159.95



**Nikon A211 Aculon 12x50**

- Field of view 272' @ 1,000 Yards
- Water resistant
- Quick, easy central focus with turn-and-slide eyecups and aspherical eyepiece lens elements
- Multi-layer coated optics
- Fully rubber armored
- Tripod adaptable

Item	Model	Ship	M.A.P.
800617	8249	3 lbs	\$129.95



**Standard Binoculars**



**5 YEAR LIMITED WARRANTY!**



**Fujinon Mariner Series 7x50**

Fujinon Mariner Series binoculars are ideal for marine leisure activities. Designed primarily for use on boats, these binoculars are waterproof, lightweight and rugged. The combination of reasonable price and high functionality makes these binoculars ideal for use not only on the water but everywhere else as well.

- 100% waterproof
- Polycarbonate housings
- Maximum brightness - fully coated optics

Model	WP-XL (no compass)	WPC-XL (with compass)
Magnification	7	7
Obj. lens diameter	50 mm (1.94")	50 mm (1.94")
Eye relief	18 mm (0.71")	18 mm (0.71")
Apparent field of view	351 Ft. @ 1000 yards	368 Ft. @ 1000 yards
Exit pupil mm	7.1 mm (0.28")	7.1 mm (0.28")
Relative brightness	51	51
Length	184 mm (7.24")	184 mm (7.24")
Max width	194 mm (7.64")	194 mm (7.64")
Weight	31 oz.	31 oz.
Foam flotation neck S=strap	Yes	Yes
Waterproof	Yes	Yes
Warranty	1 Year Limited	1 year limited

**Fujinon Polaris FMT Series 7x50**

- Unique EBC coating allows 95% of light to pass through the binocular great for low-light performance.
- Field flattener lens provides sharp images from edge-to-edge, with no distortion.
- Designed with waterproof and fogproof seals (nitrogen purged). O-ring sealed.
- Rubber armored body allows user to have a firm grip, even with one hand.
- Mil spec shock and impact resistant body construction.

Model	FMTR-SX (no compass)	FMTRC-SX (with compass)
Magnification	7	7
Obj. lens diameter	50 mm (1.94")	50 mm (1.94")
Eye relief	23 mm (0.71")	23 mm (0.71")
Apparent field of view	394 Ft. @ 1000 yards	394 Ft. @ 1000 yards
Exit pupil mm	7.14 mm (0.28")	7.14 mm (0.28")
Relative brightness	51	51
Length	200 mm (7.87")	200 mm (7.87")
Max width	218 mm (8.58")	218 mm (8.58")
Weight	3.35 lbs	3.46 oz.
Foam flotation neck strap	Yes	Yes
Waterproof	Yes	Yes
Warranty	5 year limited	5 year limited

Item	Model	Ship	Net
802797	WP-XL w/o compass	3 lbs	\$174.99
802798	WPC-XL w/compass	3 lbs	M.A.P. 229.95

Item	Model	Ship	M.A.P.
802807	FMTR-SX	5 lbs	\$699.95
802808	FMTRC-SX w/compass	5 lbs	849.95

**Image Stabilized Binoculars**



**Fujinon Techno-Stabi™ 12x28**

Enjoy the power of 12x magnification without having to use a tripod. With image stabilization of ±3°, you'll see the details of far-off subjects without the hand shake that spoils the image of non-stabilized, high-power optics. It's especially useful when viewing from a moving boat or vehicle. The TS 12x28 uses Optical Stabilized technologies to minimize the synergistic vibration that typically occurs just from holding the unit. The multi-coated optics allow for exceptional light transmission, which is great for low-light performance.



Magnification	12x
Obj. lens diameter	28 mm
Eye relief	14 mm
Real field of view	55.3°
Apparent field of View	5°
Prism type	Roof prism
Focus method	Manual by turning knob
Dioptric correction	+/-3.0 diopters
Correction angle	+/-3°
Power source	1 x CR2
Dimensions	150 x 120 x 50 mm
Weight	Approximately 1 lb

Item	Model	Ship	Net
803509	TS12x28	4 lbs	\$599.99

**Fujinon Techno-Stabi™ 14x40**

Unlike so-called image stabilizing binoculars that can only compensate for hand tremors and cannot go near the water, the Techno-Stabi can be used anywhere! Comes with a flotation strap for use on or around the water. Includes a mil spec hard case for secure storage when not in use.



Magnification	14x
Obj. lens diameter	40 mm
Eye relief	13 mm
Field of view	210.0' @ 1000 yd
Angle of View	4°
Prism type	Roof prism
Focus method	Manual by turning knob
Dioptric correction	+/-4.0 diopters
Correction angle	+/-5°
Power source	(4) AA alkaline batteries (Included)
Dimensions	186 x 148 x 86 mm
Weight	Approximately 3 lbs

Item	Model	Ship	M.A.P.
803489	TECHNO STABI 14X40	9 lbs	\$1299.95

**Binocular Accessories**

**STEINER FLOAT STRAP**

Fits all Steiner's 7x50 binoculars and most other binoculars (this model is for all loop fastening models). Bright Yellow padding for enhanced visibility. Floating strap is 2.17" wide. Long-lasting and durable nylon exterior won't fade in sunlight.



Item	Model	Ship	Net
800139	768	1 lbs	\$29.99

**BECKSON SOFT-MATE BINOCULAR HOLDER**

Soft flexible PVC. Holds binoculars, books, magazines, tools, etc.

Item	Model	Size	Ship	Net
613519	HH-4	8-1/4"H x 8-3/4"W x 2-3/4"D	2 lbs	\$49.99



**SEATEAK BINOCULAR RACK**

Hand-sanded and hand-finished 100% teak. Designed for binoculars without a built-in compass.

Item	Model	Outside Dimensions	Ship	Net
401175	62702	8-5/8" L x 3-1/2" W x 4-7/8" H	2 lbs	\$23.99



**M.A.P.** Some manufacturers set M.A.P. (Minimum Advertised Pricing) for their products, so we cannot advertise a lower price. However, this does not always apply to selling price. The actual price you will be charged is probably lower. Please call us at 800-628-8225 for further details.

# RITCHIE®

## GLOBEMASTER



Defender offers and supports the full line of Ritchee Globemaster compasses. Visit [defender.com](http://defender.com) for more details.

All models feature: Built-in compensators, DirectiveForce magnets for fast heading lock-on, 12 VDC Green Night Lighting and a 5-year warranty.

## VENTURE SR-2

SR-2



INC-45 Clinometer included

## VENTURE SR-2 BULKHEAD COMBIDIAL

Item	Model	Boat Style	Dial Style	Mount Hole	Ship	Net
800091	SR-2	Sail	3-3/4" CombiDial	4-5/8" - 4-13/16"	3 lbs	\$214.99

## NAVIGATOR



BN-202

DNW-200

FN-201

## NAVIGATOR

Item	Model	Boat Style	Dial Style	Mount Hole	Ship	Net
<b>Bulkhead Mount</b>						
802914	BN-202	Power, Sail	4-1/2"	5-3/4"	3 lbs	\$354.99
803118	BN-C Front Cover	-	-	-	1 lbs	32.99
803119	NC-20 Back Cover	-	-	-	1 lbs	39.99
<b>Binnacle Mount</b>						
802914	DNP-200 Stainless	Power, Sail	4-1/2" Flat	-	4 lbs	434.99
802915	DNB-200 Black	Power, Sail	4-1/2" Flat	-	4 lbs	434.99
802916	DNW-200 White	Power, Sail	4-1/2" Flat	-	4 lbs	434.99
<b>Flush Mount</b>						
802918	FN-201 Black	Power, Sail	4-1/2" Flat	4-3/4" - 5-1/8"	3 lbs	329.99
802917	FNW-201 White	Power, Sail	4-1/2" Flat	4-3/4" - 5-1/8"	3 lbs	329.99

## VOYAGER



RU-90

F-82

B-81

B-80

## VOYAGER

Item	Model	Boat Style	Dial Style	Mount Hole	Ship	Net
<b>Flush Mount</b>						
802899	RU-90	Power, Sail	3" Flat	3-1/2" - 4-1/8"	2 lbs	\$129.99
802898	F-82	Power, Sail	3" Flat	3-1/2" - 4-1/8"	2 lbs	142.99
<b>Bracket Mount</b>						
802891	B-81	Power, Sail	3" CombiDial	-	2 lbs	146.99
802892	B-80	Power, Sail	3" Flat	-	2 lbs	146.99

## SUPERSPORT



SS-1002

SS-2000

## SUPERSPORT FLUSH MOUNT

Item	Model	Boat Style	Dial Style	Mount Hole	Ship	Net
802874	SS-2000	Power	4-1/2" Blue PowerDamp Flat	4-3/4" - 5-1/8"	3 lbs	\$399.99
805348	SS-1002	Power	3-3/4" Blue PowerDamp Flat	4"	2 lbs	224.99

## HELMSMAN



HB-741

HD-744

HF-742

## HELMSMAN

Item	Model	Boat Style	Dial Style	Mount Hole	Ship	Net
<b>Bracket Mount</b>						
800026	HB-741	Power, Sail	3-3/4" CombiDial	-	3 lbs	\$209.99
800025	HB-740	Power, Sail	3-3/4" Flat	-	3 lbs	209.99
<b>Deck Mount</b>						
800028	HD-744	Power, Sail	3-3/4" Flat	-	2 lbs	224.99
800034	HD-745	Power, Sail	3-3/4" CombiDial	-	3 lbs	224.99
<b>Flush Mount</b>						
805359	HF-742	Power, Sail	3-3/4" Flat	4"	2 lbs	199.99

## EXPLORER



V-57W.2

F-50

S-53

B-51

F-50W

## EXPLORER

Item	Model	Boat Style	Dial Style	Mount Hole	Ship	Net
<b>Dash Mount</b>						
802879	V-57W.2 White	Power	2-3/4" Direct Read	3"	1 lbs	\$82.99
803513	V-57.2 Black	Power	2-3/4" Direct Read	3"	1 lbs	84.99
<b>Bracket Mount</b>						
802885	B-51 Black	Power	2-3/4" Direct Read	-	1 lbs	76.99
802886	B-51G Gray	Power	2-3/4" Direct Read	-	1 lbs	76.99
<b>Flush Mount</b>						
802889	F-50 Black	Power	2-3/4" Direct Read	3-3/4"	1 lbs	84.99
802890	F-50W White	Power	2-3/4" Direct Read	3-3/4"	1 lbs	84.99
<b>Surface Mount</b>						
802881	S-53 Black	Power	2-3/4" Direct Read	-	1 lbs	76.99



# Plastimo Compasses

CONTEST COMPASS RANGE							
Item	Color	Mounting Type	Card	Zone	Card Dia.	Ship	Net
<b>Mini Contest</b>							
803066	Specify Color	Bulkhead Flush	Conical	A	3.2"	2 lbs	\$154.99
<b>Contest 101</b>							
800711	Specify Color	Bulkhead Flush	Conical	Universal	4"	2 lbs	\$264.99
800712	Specify Color	Tilted Bulkhead Flush	Conical	Universal	4"	2 lbs	264.99
<b>Contest 130</b>							
800720	Specify Color	Bulkhead Flush	Conical	A	5"	4 lbs	\$289.99
800721	Specify Color	Tilted Bulkhead Flush	Conical	A	5"	4 lbs	289.99
OLYMPIC COMPASS RANGE							
<b>Olympic 115</b>							
800716	Specify Color	Flushmount	Flat	Universal	4"	3 lbs	\$264.99
800717	Specify Color	Flushmount	Conical	Universal	4"	3 lbs	264.99
800718	Specify Color	Tilted Flushmount	Conical	Universal	4"	3 lbs	264.99
<b>Olympic 135</b>							
800724	Specify Color	Pedestal	Flat	A	5.1"	5 lbs	\$339.99
OFFSHORE COMPASS RANGE							
<b>Offshore 75</b>							
800707	Specify Color	Flushmount	Conical	Universal	70mm	3 lbs	\$134.99
800708	Specify Color	Tilted Flushmount	Conical	A-B	70mm	1 lbs	142.99
<b>Offshore 95</b>							
800725	Specify Color	Flushmount	Flat	A	3.2"	2 lbs	\$174.99
800726	Specify Color	Flushmount	Conical	A	3.2"	2 lbs	174.99
800727	Specify Color	Bracket Mount	Flat	A	3.2"	2 lbs	189.99
800728	Specify Color	Bracket Mount	Conical	A	3.2"	2 lbs	184.99
<b>Offshore 105</b>							
800709	Specify Color	Flushmount	Flat	Universal	3.6"	3 lbs	\$259.99
800710	Specify Color	Flushmount	Conical	Universal	3.6"	5 lbs	274.99
<b>Offshore 115</b>							
800714	Specify Color	Flushmount	Flat	Universal	4"	3 lbs	\$264.99
800715	Specify Color	Flushmount	Conical	Universal	4"	3 lbs	264.99
<b>Offshore 135</b>							
800729	Specify Color	Flushmount	Flat	A	5.1"	4 lbs	\$274.99
800730	Specify Color	Flushmount	Conical	A	5.1"	4 lbs	299.99

THERE ARE MULTIPLE COMPASS/CARD COLOR COMBINATIONS.  
PLEASE CALL 800-628-8225 OR VISIT DEFENDER.COM FOR COLOR OPTIONS.



Mini-Contest

Contest 130 Bracket Mount



Olympic 135



Olympic 135 with Binnacle



Offshore 75

Offshore 95

Offshore 105

Offshore 135

## Ritchie® X-Port Tactician™ Surface Mount

- CombiDial with tactical quadrants show wind shifts and headers
- CourseMinder™ movable bezel and heading indicator locks-in rhumb or lay lines
- Forward lubber line to steer magnetic courses; 45° lubber lines; 25° heel angle
- Compact 4-1/4" base diameter; low 2-3/4" mounted height
- Twist on/off for easy removal
- High-visibility Blue 3" dial with extra large numerals



## Ritchie SportAbout™

- Easy-to-read 2" direct-reading dial
- International safety Yellow case; 2-9/16" diameter
- Silicone impact-resistant case with neck lanyard
- QuickSight V-Notch and lubber line for heading alignment
- Comes with chem sticks for night lighting
- Exclusive 5-year Ritchie warranty



## Weems & Plath Hand Bearing Compass

- Factory certified accurate to within 1°; durable and easy to use day or night
- Liquid dampened card with contrasting Black and Red numbers
- Photo luminescent night lighting
- Colorful, sturdy rubber housing protects the compass
- 1-3/16" x 3-3/16"
- Includes lanyard
- Works at high altitudes



Lifetime Warranty!

Item	Model	Ship	M.A.P.
805447	2005	1 lbs	\$129.99

## Davis Handbearing Compass

- Simply frame the target in the rear sight and align it with the front sight
- Direct-reading; liquid-damped
- Rugged plastic construction
- (2) AAA Batteries included



Item	Model	Ship	Net
803004	215 w/LED	1 lbs	\$39.99

## Plastimo Floating Iris® 100 - Universal

- Soft rubber casing protects against shocks
- Magnetic set keeps it horizontal at any angle
- Includes case, bracket and assembly
- Double reading, gimbaled, cone shaped card
- Two mobile lubber lines
- Dial: 2.37" Diameter

Item	Model	Description	Ship	Net
800693	63875	Blue trim with LED	2 lbs	\$242.99
	63874	Blue trim without LED	1 lbs	157.99
800695	63877	Yellow trim with LED	2 lbs	242.99
	63876	Yellow trim without LED	1 lbs	164.99



5 Year Warranty!

## Plastimo Iris 50 - Zone A/B

- Course reading from above
- Wide, 20° field of view
- Built-in photoluminescent lighting
- Outstanding legibility with 1° graduations
- Ultra-sonic welding prevents bubbles and leaks
- No parallax error
- Operates without batteries
- 3.32" dia. x 1.32" H
- Will not slip when wet

Item	Model	Color	Ship	Net
800696	63870	Blue	1 lbs	\$119.99
	63871	Yellow	1 lbs	119.99



5 Year Warranty!

Calibrated as a dual zone compass. Zone A: North Atlantic and North Pacific  
Zone B: South Atlantic, Indian Ocean, Central Pacific, Tahiti, Reunion Island

NEW!

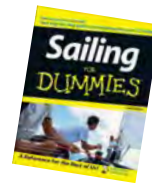

NEW!

**2019 ELDRIDGE TIDE AND PILOT BOOK, 145th Edition**

Reference for East Coast power and sailboaters from Nova Scotia to Key West. Contains: Daily tides/currents, current diagrams, navigation rules and regulations, weather, GPS, lights and fog signals, first aid and much more.

Item	Description	Ship	Net
050451	272 pages, Paperback	1 lbs	\$13.99

**NAUTICAL ALMANAC 2019**

The cornerstone for all celestial navigation, listing the celestial bodies used for navigation, a sight reduction table and other information valuable to the offshore navigator. The content is identical to the United States Naval Observatory edition.

Item	Description	Ship	Net
050927	272 pages, Paperback	2 lbs	\$25.99

**THE ONE-MINUTE GUIDE TO THE NAUTICAL RULES OF THE ROAD, 2nd Edition**

The United States Power Squadron's Guide and a quick access guide to international and US boating rules of the nautical road satisfies the Coast Guard requirement. This expanded edition provides rule-by-rule translations of what each one really means when applied on the water. Complete with color diagrams.

Item	Description	Ship	Net
050711	157 pages	1 lbs	\$18.99

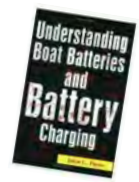
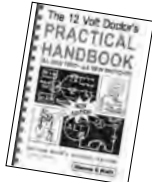
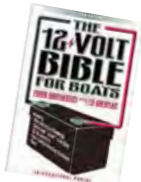
**ELECTRICAL & MECHANICAL BOOKS**

**THE 12 VOLT BIBLE FOR BOATS, 2nd Edition** Author: Miner Brotherton. Clear introduction to 12 Volt electrical systems used on small boats. Thoroughly updated as to modern equipment, materials and practices while retaining the simplicity that made the 1st edition a boating best-seller.

Item	Description	Ship	Net
050359	194 pages, Paperback	1 lbs	\$16.99

**12 VOLT DOCTOR'S PRACTICAL HANDBOOK** Author: Edgar J. Beyn. Covers basic electricity, switches, troubleshooting, engine instruments, safety standards, solar power, batteries, pumps and electrolytic corrosion.

Item	Description	Ship	Net
050361	220 pages, Spiral bound	1 lbs	\$25.99

**THE 12 VOLT DOCTOR'S ALTERNATOR BOOK** Author: Edgar J. Beyn.

The 12 Volt Doctor's Alternator Book simplifies the mysteries of the boat's alternator. Includes simple drawings and clear instructions which help the boater understand his or her alternator. Basic understanding can save your battery's life.

Item	Description	Ship	Net
050360	93 pages, Spiral Bound	1 lbs	\$30.99

**UNDERSTANDING BOAT WIRING** Author: John Payne. Well illustrated, confidence-inspiring guide to wiring and wiring standards, electricity basics, circuit protection, planning and installation, switches, grounding and more.

Item	Description	Ship	Net
050719	89 pages, Paperback	1 lbs	\$12.99

**BOATOWNER'S ILLUSTRATED ELECTRICAL HANDBOOK, 2nd Edition** Author: Charlie Wing. Maintain, repair and upgrade your boat's DC and AC electrical systems. Covers onboard electrical projects from fixing loose connections to rewiring your boat to ABYC standards.

Item	Description	Ship	Net
050599	320 pages, Hardcover	3 lbs	\$34.99

**UNDERSTANDING BOAT CORROSION, LIGHTNING PROTECTION & INTERFERENCE**

Author: John Payne. Includes galvanic corrosion, what it is and how to avoid it, stray current corrosion and protecting against it, lightning protection, grounding and much more.

Item	Description	Ship	Net
050718	96 pages, Paperback	1 lbs	\$12.99

**MARINE MEDICINE GUIDE**

**MARINE MEDICINE - A COMPREHENSIVE GUIDE, 2nd Edition**  
Medical advice for sailing, pleasure boating, fishing, and emergencies. More than 100 illustrations. This edition features the latest information on marine first aid and includes chapters on hazardous marine life, submersion injury, dive medicine, rescue and evacuation, wound cleaning/closing and more.

Item	Description	Ship	Net
050194	333 pages, Paperback	1 lbs	\$14.99

**US CHART NO. 1 - NAUTICAL SYMBOLS, ABBREVIATIONS & TERMS USED ON**

**NAVIGATIONAL CHARTS, 12th Edition** This edition presents both of the major symbology sets used for marine navigation. The symbols used on paper nautical charts produced by NOAA and the NGA and digital raster representations of those charts, such as NOAA Raster Nautical Chart (NOAA RNC's) are presented in lettered sections organized in categories. New in this edition are the corresponding symbols used to portray Electronic Navigational Chart (ENC) data on Electronic Chart Display and Information Systems (ECDIS) as specified by the International Hydrographic Organization (IHO).

Item	Description	Ship	Net
050321	129 pages, Spiral bound	1 lbs	\$13.99

**SAILING FOR DUMMIES** Author: Peter and J.J. Isler. This hands-on guide helps you chart a course to sailing success, from getting familiar with nautical terms and seamanship basics to setting sail, navigating, anchoring and docking or even riding out a storm.

Item	Description	Ship	Net
050625	432 pages, Paperback	1 lbs	\$19.99

**CHAPMAN PILOTING - SEAMANSHIP & SMALL BOAT HANDLING, 68th Edition**

Re-written and re-illustrated in color. Covers marine electronics, satellite navigation, communications systems and safety at sea.

Item	Description	Ship	Net
050921	920 pages, Hardcover	7 lbs	\$55.99

**UNDERSTANDING BOAT BATTERIES & BATTERY CHARGING** Author: John Payne.

An easy-to-understand guide to the foundation of a marine electrical system: batteries and the systems that charge them. Topics include battery types, selection, safety, installation, maintenance, charging, alternators, regulators and more.

Item	Description	Ship	Net
050717	89 pages, Paperback	1 lbs	\$13.99

**SAILBOAT ELECTRICAL SIMPLIFIED** Author: Don Casey.

Basic Marine DC / AC circuit trouble shooting with 320 Illustrations. Boat wiring has never been more clearly explained and illustrated.

Item	Description	Ship	Net
050358	176 pages, Hardcover	2 lbs	\$20.99

**BOATOWNER'S MECHANICAL AND ELECTRICAL MANUAL, 4th edition**

Author: Nigel Calder

Packed with new and updated information on every system found aboard virtually every pleasure boat. If it has screws, wires or moving parts, it's covered in this trusted manual. Includes troubleshooting chart and clear illustrations. Dimensions: 8 1/2" x 11".

Item	Description	Ship	Net
050429	944 pages, Hardcover	1 lbs	\$55.99

**SPlicing & KNOTS BOOKS****THE SPlicing HANDBOOK, 3rd Edition**

Author: Barbara Merry. Includes step-by-step illustrations and explanations for the most useful and popular splices in traditional twisted and modern braided ropes.

Item	Description	Ship	Net
050402	256 pages, Paperback	1 lbs	\$19.99

**REEDS KNOT HANDBOOK: A COMPLETE GUIDE TO KNOTS, HITCHES AND BENDS** Author: Jim Whippy.

Whether a knot is strong under load, quick to release, works well in wet conditions or with different types of rope/cord, you will be able to select the correct knot for every situation.

Item	Description	Ship	Net
050183	128 pages, Paperback	1 lbs	\$8.99

**CREATIVE ROPECRAFT** Author: Stuart Grainger.

Widely considered the standard work on both practical and decorative knotwork, packed with the author's exquisite, detailed line illustrations for projects ranging from belts, mats, hammocks, trays and lamps.

Item	Description	Ship	Net
050697	122 pages, Paperback	1 lbs	\$15.99

**THE KNOTS BOX: USEFUL KNOTS FOR EVERY SITUATION, INDOORS AND OUT** Author: A. Hyatt Verrill. The Knots Box covers all the fundamentals of knot tying, from simple to strong, tight, and hard working.

Item	Description	Ship	Net
050893	88 pages, Paperback	1 lbs	\$11.99





**Sextants**



**CELESTAIRE ASTRA IIB SEXTANT**

Excellent optics and lightweight aluminum alloy frame. LED lighting of the arc and drum powered by AA batteries (not included). Comes in a varnished wooden case with standard 3.5 x 40 scope, instruction booklet, certificate of accuracy, oil, adjusting wrench, spare bulb and springs. Accuracy +/- 20 sec. throughout the arc. Has a front silvered index mirror for better reflection.

Item	Ship	M.A.P.
<b>800590</b>	Specify whole horizon mirror or traditional split mirror. 9 lbs	<b>\$699.00</b>



**CELESTAIRE ASTRA III PRO SEXTANT**

- Frame material: Bronze arc fused to an aluminum frame
- LED lighting of the arc and drum (requires 2 AA batteries - not included)
- Wooden case • 3.5 x 40 telescope
- Instruction book included • Adjusting wrench included
- Certificate of accuracy

Item	Ship	M.A.P.
<b>800591</b>	Specify whole horizon mirror or traditional split mirror 10 lbs	<b>\$875.00</b>



**DAVIS MARK III TRAINING SEXTANT**

Includes booklet describing how to find your position accurately anywhere on earth. Used by professional and amateur navigators alike. Rugged, full sized and reads to within 2 minutes of arc.

Item	Model	Ship	Net
<b>803267</b>	<b>011</b>	1 lbs	<b>\$47.99</b>



**DAVIS MICROMETER MASTER SEXTANT**

Features these professional specifications: precision machined slow travel gear and worm-gear mechanism; highly visible, easy-to-read micrometer drum and vernier allowing readings to 2/10 minute of arc. 7 large sunshades allow complete, independent adjustment of shading density for horizon and index mirrors; 3-power telescope with anti-reflective coated glass lenses, plus separate hooded sight tube for glare-free sun shots. The Mark 25 features a full-field Beam Converger™ that replaces conventional half-silvered mirror, an improved reinforced plastic that stiffens the frame for greater measurement accuracy and an LED illuminating system. Case included.

Item	Model	Ship	Net
<b>803269</b>	<b>025 Mk 25</b>	4 lbs	<b>\$207.99</b>

**Waterway Guides**

**WATERWAY GUIDES**

Updated annually by on-the-water cruising editors, Waterway Guide's seven editions cover coastal waters from Maine to Florida, the Bahamas, Cuba, the Gulf of Mexico, the Great Lakes and the inland waterways of the Great Loop cruise.

- Guides are spiral bound and clearly organized
- Sections are color-coded for easy reference
- Region-specific "Skipper's Handbook" is in each edition
- Covers hundreds of marinas with charts showing precise locations and comprehensive data on amenities
- Each guide features navigation alerts, anchorage information, photos with routes to assist with planning, docking, bridge and lock schedules and mileage charts



**WATERWAY GUIDE NORTHERN 2019**

Long Island Sound and New England waters, from Cape May, New Jersey to Maine  
Item **050951** Model **9780998586397** Ship 4 lbs Net **\$38.99**

**WATERWAY GUIDE SOUTHERN 2019**

Florida, the Keys and the Gulf Coast to Brownsville, TX  
Item **050947** Model **9780998586373** Ship 4 lbs Net **\$38.99**

**WATERWAY GUIDE CHESAPEAKE BAY 2019**

Cape May, New Jersey to Norfolk, VA, Delaware Bay and C & D Canal  
Item **050945** Model **9780998586366** Ship 3 lbs Net **\$38.99**

**WATERWAY GUIDE GREAT LAKES 2019, VOLUME I**

Hudson River and the New York Canal system plus the waterway of Lake Ontario; Lake Huron and Lake Erie  
Item **050949** Model **9781732514201** Ship 3 lbs Net **\$38.99**

**WATERWAY GUIDE GREAT LAKES 2019, VOLUME II**

Lake Superior and Lake Michigan plus the Inland Rivers from Chicago to the Gulf Coast  
Item **050950** Model **9781732514218** Ship 3 lbs Net **\$38.99**

**WATERWAY GUIDE ATLANTIC ICW 2019**

Intracoastal Waterway from Norfolk, Virginia to Jacksonville, Florida  
Item **050946** Model **9780998586359** Ship 3 lbs Net **\$38.99**

**WATERWAY GUIDE BAHAMAS 2019** Bahamas plus Turks and Caicos Islands

Item **050948** Model **9780998586380** Ship 3 lbs Net **\$38.99**

**WATERWAY GUIDE CUBA**

Item **050907** Model **978-0-9968998-7-1** Ship 2 lbs Net **\$52.99**

**Cruising Guides**



**SKIPPER BOB'S CRUISING SERIES**

Skipper Bob and his wife Elaine cruised over 44,000 miles while living aboard both a trawler and a sailboat. In authoring these guides, he wanted to provide others with the knowledge he gained through his years of experience. All ship 1 lbs.

Item	Description	Net
<b>050952</b>	Anchorage Along the Intracoastal Waterway, 23rd Edition	<b>\$15.99</b>
<b>050953</b>	Marinas Along the Intracoastal Waterway, 22nd Edition	<b>13.99</b>
<b>050958</b>	Cruising the New York Canal, 22nd Edition	<b>11.99</b>
<b>050959</b>	Cruising the Trent-Severn Canal, 19th Edition	<b>11.99</b>
<b>050954</b>	Cruising the Gulf Coast, 15th Edition	<b>14.99</b>
<b>050944</b>	Cruising America's Great Loop, 17th Edition	<b>17.99</b>
<b>050955</b>	Bahamas Bound, 17th Edition	<b>14.99</b>
<b>050961</b>	Cruising the Rideau and Richelieu Canals, 21st Edition	<b>11.99</b>
<b>050889</b>	Cruising Comfortably on a Budget, 15th Edition	<b>22.99</b>
<b>050960</b>	Cruising from Chicago to Mobile, 15th Edition	<b>14.99</b>

**THE INTRACOASTAL WATERWAY CHARTBOOK, 6TH EDITION** by John Leslie Kettlewell  
234 strip charts of the waterway from Norfolk to Miami reproduced in full color. Preferred route is clearly marked in Magenta for the entire route. Statute miles noted in five-mile increments in the margins. Marinas are marked on charts with phone numbers. 11.7" x 8.5" x 1.2".  
Item **050308** Spiral-bound, 304 pages Ship 2 lbs Net **\$73.99**

**THE INTRACOASTAL WATERWAY - NORFOLK TO MIAMI, 6TH EDITION**  
The piloting guide of choice for boaters traversing the Intracoastal Waterway between Virginia and Florida. Double the size of its predecessor and includes enhanced coverage of anchorages, pilotage and facilities. 8.5" x 11".  
Item **050668** Paperback, 244 pages Ship 2 lbs Net **\$29.99**

**VOYAGING WITH KIDS - A GUIDE TO FAMILY LIFE AFLOAT** by Behan Gifford, Sara Dawn Johnson, Michael Robertson. Choosing a boat that is right for your family; handling the naysayers; keeping your children safe, healthy and entertained afloat - this inspirational and comprehensive guide may be just what you need to turn your dream into a reality.  
Item **050432** Paperback, 320 pages Ship 3 lbs Net **\$18.00**

**THE CRUISING LIFE: A COMMONSENSE GUIDE** by Jim Trefethen. Thousands of ordinary people are living their dreams of sailing the world thanks to The Cruising Life, and this completely updated 2nd Edition aims to help thousands more find adventure over the horizon. Even if you've never sailed before, this A-to-Z guide can have you cruising to exotic ports within five years.  
Item **050431** Hardcover; 304 pages Ship 2 lbs Net **\$22.99**

**GUIDE TO PLANNING & CRUISING THE GREAT CIRCLE ROUTE, 2ND EDITION** by G. Bickley Remmey Jr. Revised by Laura Cannell. This updated edition is a comprehensive, mile-by-mile guide to the longest cruise possible in the United States, extending from Florida through the ICW, the Erie Canal, Great Lakes, the Illinois River and along the Gulf Coast. 8.9" x 5.9".  
Item **050628** Paperback; 232 pages Ship 1 lbs Net **\$21.99**

**CORNELL'S OCEAN ATLAS, 2ND EDITION** by Jimmy and Ivan Cornell. This book contains (60) monthly pilot charts of the world's oceans and (69) detailed charts of the most commonly sailed transoceanic routes. 11.7" x 16.5".  
Item **050922** Spiral-bound; 120 pages Ship 3 lbs Net **\$72.99**

**WORLD CRUISING ROUTES, 8TH EDITION** The primary guide to planning routes and itineraries when sailing across an ocean or around the world. Geared specifically to the needs of small-boat sailors, over 1000 routes are defined by the best time of year for the passage, prevailing winds and currents and the most favorable routes to take. 10" x 7.9" x 1.6".  
Item **050926** Flex Cover; 616 pages Ship 4 lbs Net **\$55.99**



## Navigation Software



### CHART NAVIGATOR SOFTWARE

#### Key Planning Features:

- Find the chart you want quickly - graphically or by chart name/number
- Link 2 or more charts, photos and 3D together in split-screen mode
- Quick dragging, zoom and scale options
- Routes: Plan and organize routes with your mouse
- Print route plans and chart segments
- Print and view tide and current graphs

#### Key Navigation Features:

- GPS ready: View your position on the chart
- Autopilot ready: Outputs NMEA 0183 data to autopilots
- 6 color palettes for all light conditions
- Marks: Mark areas of interest and "Go To" them quickly
- Man Overboard: Instant range and bearing to MOB location
- Tracks: Record where you've been with an option to convert tracks to routes
- Alarms: Create custom alarm areas including anchor alarms
- Measurement tools: A2B and instant range and bearing lines based on GPS position

#### Minimum System Requirements

- PC
  - Windows 2000 or XP or higher
- Video monitor resolution of 256 colors at 800 x 600 (or better)
- 1 GB of free disk space
- Microsoft Internet Explorer 4.0 or higher (included)

#### GPS

- Industry-standard NMEA 0183 GPS
- Serial or USB connection cable

#### Autopilot

- Connected GPS (as above)
- Industry-standard NMEA 0183 autopilot
- Serial data connection cable
- Note: Autopilot interface is not required

Item	Model	Ship	Net
256539	SWCNS	2 lbs	\$229.99



### CHART NAVIGATOR PRO SOFTWARE

#### Features

- Maptech's GPS planning and navigation software
- ALL raster, vector, contour 3D, photo, topo and more
- ALL US coastal areas and major river systems on USB flash drive
- Weather forecasts and free chart updates via the Internet

#### Planning

Chart Navigator Pro makes it easier to plan your next cruising adventure with features like chart quilting, multi-level undo, integrated gazetteer, geo-referenced Coast Pilot and route obstacle detection. Connect to the

Internet, and you can download the latest weather forecasts and charts.

#### Navigation

Made easier with Chart Navigator Pro's full-screen cruise mode which replaces the standard Windows menus and toolbars with big, fat buttons that are much easier to use while underway.

#### Charts

Chart Navigator Pro includes the entire US coastline on a USB flash drive. There are no US "regions" or "unlocks" to worry about - every chart for the US coastline is included. The cartography includes the Atlantic Coast, Gulf Coast, major Inland Waterways and the US waters in the Great Lakes as well as the Pacific Coast, Alaska and Hawaii. These aren't overview charts - they include the most detailed charts Maptech has to offer.

#### PC minimum requirements are

- Windows 2000 or XP or higher
- USB flash drive
- 1 GB of available hard disk space for program and related databases
- Super VGA (800 x 600) or higher resolution monitor

Item	Model	Ship	Net
805416	SWCNPRO	2 lbs	\$369.99



### NAVIGATION US BOATING CHARTS WITH TIDES & CURRENTS ON DVD

#### Features

- Each tide station is labeled with the present tidal height and includes an arrow that indicates whether the tide is ebbing or flooding
- Right click on an icon to read the station name, view its tide graph or get additional data about the station
- The tide graph shows the time and estimated water height of predicted high and low tides

- Current graph shows fluctuations in the current's speed and direction hour to hour
- Tide and current data for a two year period

#### Navigational Software

- The PC Navigational software lets users easily create routes by clicking the mouse for real-time navigation or trip planning
- Each click puts a waypoint on a chart
- Click again and you're creating a route
- Chart segments and route plans can be printed on standard printers
- If you have a computer onboard, connect a GPS to it and you will see your vessel's location on the detailed charts for real-time tracking and positioning

#### Complete US Coverage

- USB flash drive covers the entire US and is arranged in 23 "Chart Kit Regions" which makes it easy to find specific charts for all your favorite boating and fishing areas

Item	Model	Ship	Net
253761	DVDRUSTC	1 lbs	\$94.99

#### MAPTECH USB GPS RECEIVERS

- 48-channel, waterproof design. 2.08" diameter x 0.75" • NMEA compatible
- WAAS and EGNOS enabled • Magnetic housing for secure positioning
- OS compatibility: Windows: XP/Vista/7/8/10; MAC: 10.4.11-10.6.6 + Linux and Windows CE
- Package contains one USB GPS sensor with a 5' cable and driver software

Item	Model	Ship	Net
259267	MTUSBGPS	Ship 1 lbs	Net \$94.99



### Rose Point Coastal Explorer

- Advanced route planning featuring multi-level undo, powerful route manipulation tools, and route obstacle detection
  - Easy access to NOAA weather, and guidebook information including ActiveCaptain, Coast Pilot and more
  - Support for your GPS, heading sensor, depth sounder, autopilot, water speed and temperature sensors, wind and weather instruments, AIS receiver and most NMEA 1083/2000@ instruments
- Chart support – NOAA ENC and RNC, USACE IENC, CHSDC, AVCS, C-MAP MAX/PC, NV. charts, ENC (S-57/S-63), BSB version 1-5, Maptech RML and PCS, SoftChart, PhotoChart, Rose Point charts for British Columbia

#### System Requirements:

- PC with Microsoft Windows 7, Windows 8, or Windows 10 (32-bit or 64-bit)
- 500 MB or more hard drive space (actual requirements depend on installation options)
- DVD-ROM drive or internet access for program and chart installation
- Super VGA (800 x 600) or higher resolution monitor, 1024 x 768 or higher is recommended
- NMEA 0183, NMEA 2000, or Garmin compatible GPS and/or other marine electronics with an appropriate PC interface
- Internet access required for some features

**In the box:** The box contains a DVD with the Coastal Explorer program and all US charts in raster and vector formats as well as the Exploring Coastal Explorer booklet.

Item 253749 Model 70003 Ship 1 lbs M.A.P. \$369.00



### TZ Navigator v3

TZ NAVIGATOR is the entry level product for the TIMEZERO technology. The product is designed for both recreational sailing and motor boat users. Apart from its revolutionary 3D charts, TZ NAVIGATOR includes the features below that have made the product such a success:

- Routes
- Waypoints
- Worldwide tides
- Weather forecast module
- AIS/ARPA module
- The TIMEZERO chart zones delivered with the product include a raster or vector chart zone + 3D data +
- Photos in standard resolution

#### The options available for TZ NAVIGATOR are the following:

- Furuno Radar module: Display and control of radars DRS and FAR
- Furuno Sounder module: Display and control of Furuno sounders via Ethernet
- Routing module: Calculate the optimal route taking into account the polars to provide the different speeds of the sailing boat for each angle and wind speed and the weather forecast (Wind, waves, currents)

Item 260893 Model TZ-100 M.A.P. \$475.00



### TZ Navigator Professional v3.3

#### The main TZ PROFESSIONAL features are:

- AIS/ARPA targets with anti-collision alarms
- GRIB Format weather forecast service
- 2D/3D chart fusion chart engine
- S57 Weekly updated charts
- Oceanographic forecasts for fishing zone forecasting
- Ethernet connected Furuno radar native compatibility
- Optional module monitoring
- Up to 3 monitors can be used simultaneously working on independent workspaces

#### New features:

- Furuno DFF3D MultiBeam sonar compatibility (DFF3D required)
- FLIR M200 compatibility (Flir M200 required)
- Marport Trawl positioning integration
- Marks and objects database optimization
- Import of OLEX tracks and marks.
- Provided with one token to allow you to install the software.

Item 260894 Model TZ-108 M.A.P. \$1425.00

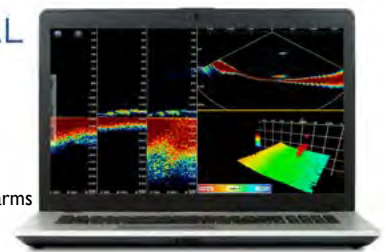

Please visit [www.Nobeltec.com](http://www.Nobeltec.com) for more information, features and system requirements.





## Shakespeare Marine Antennas

The Classic Series provides quality antennas with high-gloss epoxy finishes at affordable prices and with two year warranties. The superior construction of the Galaxy Series continues to set the standard - high-performance, durable construction, beautiful finish and five year warranties. The Galaxy ferrules are stainless steel and their proprietary, high gloss polyurethane finish won't yellow in the sun.

VHF ANTENNAS					
Item	Model	Description	Cable	Ship	Net
	251531	5911	Stowaway 10" unity gain emergency antenna	12' Cable	1 lbs \$58.99
	258414	5104	Classic 3 dB end-fed w/matching stub 4' antenna	15' RG-58	3 lbs 45.99
	261712	5101-RL	Classic 6 dB end-fed 8' antenna (93" RL)	15' RG-58	3 lbs 74.99
D	252363	5102	Classic 6 dB 8' antenna	15' RG-58	90 lbs 93.99
	257972	396-I	Classic 3 dB 5' antenna	15' RG-58	3 lbs 109.99
	261713	5225-XR-RL	Galaxy 6 dB extra-tough collinear 8' antenna (93" RL)	20' RG-8/X	5 lbs 149.99
	253766	5400-XT	Galaxy little giant 3 dB 4' antenna	20' RG-8/X	3 lbs 138.99
	260594	6400-R	Phase III 3 dB collinear 4' antenna	None	5 lbs 209.99
D	260593	6225-R	Phase III 6 dB collinear 8' antenna	None	90 lbs 247.99
	251517	5018	Galaxy 9 dB collinear 17'6" antenna	20' RG-8/X	12 lbs 419.99
	260592	6018-R	Phase III 9 dB 17'6" antenna	None	14 lbs 574.99

VHF ANTENNAS STAINLESS STEEL					
	253245	5241-R	Classic 3 dB 3' stainless steel whip	15' RG-58	3 lbs \$69.99
	251523	5215	Squatty Body® stainless steel whip w/SS "L" bracket	None	2 lbs 57.99
	256680	5242-A	Classic 3 dB low profile 36" vhf antenna	None	2 lbs 75.99
	256681	5216	Classic 15" vhf sailboat end-fed, center loaded	None	1 lbs 47.99
	251482	5215-C-X	Classic Squatty Body 3 dB 3' antenna	60' RG-8/X	5 lbs 102.99
	256343	5218	5218 VHF antenna, 19" with magnetic mount	15' RG-58	2 lbs 56.99
	257469	5215-AIS	Squatty Body 3' masthead mounting for AIS transceivers	None	2 lbs 55.99
	257550	5250-AIS	Classic Skinny Mini™ 3 dB 3' stainless steel whip	15' RG-58	3 lbs 58.99

SATELLITE RADIO/WEATHER ANTENNAS					
	260795	SRA-50	Galaxy SiriusXM® satellite antenna with 4-way mounting system	25' Cable	1 lbs \$83.99

AM/FM RADIO ANTENNAS					
	253769	4353	Classic on-glass AM/FM antenna	6' Cable	1 lbs \$42.99
	260590	4356	Classic 36" low profile Stainless Steel whip antenna	15' RG-62	2 lbs 46.99
	260589	4355	Classic 36" low profile stainless steel sailboat antenna	10' RG-62	2 lbs 47.99
	251473	4351	Classic 3' AM/FM antenna	10' RG-62	2 lbs 65.99
	260588	4354	Classic 2' low profile Stainless Steel whip antenna	10' RG-62	2 lbs 62.99
D	252886	5120	Classic 8' AM/FM antenna	15' RG-62	4 lbs 74.99
	253768	5420-XT	Galaxy 4' little giant AM/FM entertainment band	12' RG-62	3 lbs 99.99
D	255088	5235-XT	Galaxy 8' AM/FM antenna	20' RG-62	4 lbs 109.99

QUICKCONNECT VHF ANTENNAS					
	260796	QC-3	3dB 3' stainless steel ahip antenna	None	1 lbs \$26.99
	260797	QC-4	3dB 4' fiberglass antenna	None	1 lbs 47.99
D	260798	QC-8	6dB 8' fiberglass antenna	None	2 lbs 57.99

QUICKCONNECT MOUNTS All models include 20' of RG-58					
	260800	QCM-N	Nylon ratchet mount with cable for quick connect antennas	2 lbs	\$26.99
	260799	QCM-S	Stainless steel ratchet mount with cable for quick connect antennas	3 lbs	56.99
	260802	QCM-NR	Nylon ratchet rail mount with cable for quick connect antennas	2 lbs	36.99
	260801	QCM-SR	Stainless steel ratchet rail mount with cable for quick connect antennas	4 lbs	68.99

ANTENNA MOUNTS					
	256350	4711	Nylon Low profile flange mount, 1" H x 2.5" base	1 lbs	\$5.99
	256349	4710	Stainless steel low profile mount, 1" H x 2.5" Base	1 lbs	16.99
	253287	4365	Straight 4" H, 1"-1/4 thread stainless steel mount	1 lbs	22.99
	252292	4186	Nylon ratchet mount assembled	1 lbs	8.99
	252293	4187	Stainless steel ratchet mount 1" thread	2 lbs	37.99
	256679	5187	Stainless steel ratchet mount (No exterior nuts, 5° teeth)	3 lbs	42.99
	252906	4187-HD	Heavy duty ratchet mount stainless steel 1" thread	3 lbs	48.99
	257975	4722	Nylon rail mount 7/8" and 1" rails	1 lbs	12.99
	257974	4721	Nylon economy ratchet rail mount 7/8" to 1"	1 lbs	14.99
	257973	4720	Economy rail mount for round or square 7/8", 1" or 1-1/4" rail or flat surface	1 lbs	20.99
	253291	4190	Stainless steel ratchet rail mount - Side position 7/8" or 1"	2 lbs	39.99
	257752	4188-SL	Stainless steel ratchet rail mount - Top position, 1" or 1-1/4"	3 lbs	49.99
	252297	408-R	Upper bracket for 1", 1-1/8", 1-1/2" diameter antennas	1 lbs	17.99

CONNECTORS AND COUPLERS					
	254173	PL-259-G	Gold-plated PL-259 connector for RG8/AU and RG-213 coax	1 lbs	\$10.99
	255016	PL-259-CP-G	Gold-plated centerpin PL-259 for RG-58/AU or RG8/X coax	1 lbs	10.99
	259583	PL-259-8X-G	Gold-plated PL-259 for RG-8X with cable strain relief	1 lbs	10.99
	252131	PL-258-G	Gold-plated PL-258 barrel connector for RG-8X or RG-58/AU	1 lbs	7.99
	255017	PL-258-CP-G	Gold-plated centerpin PL-258 barrel connector	1 lbs	15.99
	255054	RA-259-239-G	Gold-plated right angle PL-259 to SO-239 adapter	1 lbs	11.99
	251474	4357-S	AM/FM/VHF marine band separator	1 lbs	68.99
	256351	ART-3	Art-3 antenna/radio tester	1 lbs	125.99
	260734	4360	Seawatch marine tv distribution amplifier / band separator / power supply	2 lbs	39.99

COAXIAL CABLE AND EXTENSIONS					
	257969	SRC-35	35' replacement cable for SRA-25, SRA-40 and SRA-50	1 lbs	\$44.99
	251507	4352	10' AM / FM extension cable - 93-ohm RG-62 cable with male and female Motorola connectors installed	1 lbs	35.99

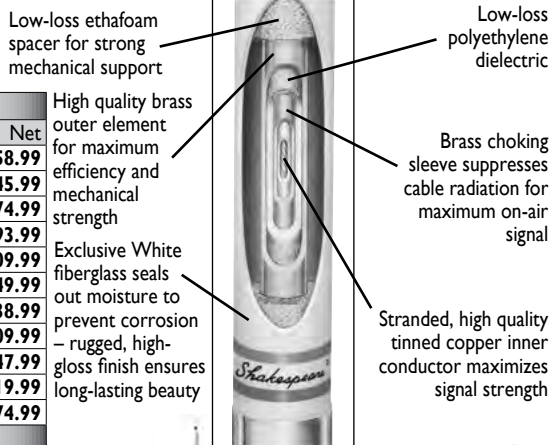



See defender.com for new Apollo series stereos with party mode



MS-BB300R

MS-AV755



MS-RA70



MS-AV650



MS-RA55

- Construction - True marine chassis
- Performance - Power • Output - Amplified output
- Warranty - 3 Years parts and labor, including all water damage
- New product development - Developing products from the "waterline" up

**RECEIVERS**

**FUSION 755 SERIES TRUE MARINE ENTERTAINMENT SYSTEMS**

- Color TFT display
- IPX5 front and rear
- Fusion Link and UNI-Dock™ ready
- Pandora control
- Single din cut-out
- 4 x 70 Class D amplifier
- Internal Bluetooth with A2DP and AVRCP
- 4-zone with discrete pre-out and sub-out

**MS-UD-755 Features:** • AM/FM/Sirius ready/USB rear • Internal UNI-Dock

**MS-AV-755 Features:** • DVD/CD/AM/FM/Sirius ready/USB rear • HDMI video out

Item	Model	Ship	Net
261555	MS-UD755	6 lbs	\$599.99
261554	MS-AV755	7 lbs	749.99
261842	MS-ARX70B/MS-ARX70W	1 lbs	49.99

(Black or White)



**FUSION MS-RA70 & MS-RA70N MARINE STEREO RADIOS**

- 50 W x 4 Class AB amplifier
- Single din cut-out
- Built-in high level Bluetooth
- AM/FM/iPhone/iPod/Android interface
- 2-zone with one discrete Pre-out and Sub-out
- IPx6 when mounted

Item	Model	Description	Ship	Net
261443	MS-RA70i	Apple or Android interface via UNI-Dock or panel mount USB cable	3 lbs	\$249.99
261405	MS-RA70Ni	Apple or Android interface via UNI-Dock with FusionLink and NMEA network	3 lbs	289.99



**FUSION BLACK BOX ENTERTAINMENT SYSTEM**

- AM/FM/SiriusXM-ready/USB/AUX/iPod/iPhone/MTP/Bluetooth
- Expandable up to 3 zones
- FUSION-Link NMEA 2000 connectivity
- Panel mount USB and 3.5 mm auxiliary cable connection
- 50 Watts x 4
- Apple & MTP Android/Windows Media playback
- A2DP audio streaming with AVRCP

Item	Model	Ship	Net
260651	MS-BB100	3 lbs	\$289.99
260469	MS-BB300R	7 lbs	479.99



**FUSION 650 SERIES MARINE ENTERTAINMENT SYSTEMS**

- Grayscale LCD display
- Fusion Link and UNI-Dock ready
- IPX5 front and rear
- 3-zone with discrete Pre-out and Sub-out
- Single din cut-out
- Pandora control
- Internal Bluetooth with A2DP and AVRCP
- 4 x 70 Class D amplifier
- 2-AUX in

**MS-UD-650 Features:** • AM/FM/Sirius ready/USB rear • Internal UNI-Dock

**MS-AV-650 Features:** • DVD/CD/AM/FM/Sirius ready/USB rear • Component video out

Item	Model	Ship	Net
260194	MS-UD650	6 lbs	\$479.99
260193	MS-AV650	7 lbs	599.99



**FUSION MS-RA55 MARINE AM/FM/iPOD STEREO**

- Output power: 40 W x 2 channels
- Display: Daylight viewable, 2.3", LCD
- A2DP Bluetooth wireless technology
- AM/FM/iPod/iPhone ready\*
- IPX5 front and rear
- MultiZone™ technology

Item	Model	Description	Ship	Net
261200	MS-RA55	MS-RA55 Marine stereo	2 lbs	\$179.99
258807	MS-RA200MP	Adaptor plate	1 lbs	13.99



**FUSION STEREOACTIVE PORTABLE WATERSPORT BLUETOOTH MARINE STEREO**

- Functions: Bluetooth / AM/FM radio / USB / iPhone / Android / Weatherband\*
- Input: USB and Bluetooth, Power: Rechargeable, select color: Blue, Red, or White
- Max. output power: 40 W, mount: Puck mount, portable • 20 hour battery life

Item	Model	Description	Ship	Net
261444	WS-SA150	Watersport marine stereo	5 lbs	\$209.99
261445	WS-DK150	ActiveSafe floating waterproof case	2 lbs	94.99



**AMPLIFIERS & SPEAKERS**



MS-BT100

MS-BT200

MS-OS420



MS-EL602

XS-F65CWB



XS-FL65SPGW

MS-SW10

MS-AM-504



MS-AM702

SG-DA51600

**FUSION MARINE BLUETOOTH MODULES** Streams audio from Bluetooth capable devices

Item	Model	Applications	Ship	Net
259679	MS-BT100	Any stereo with auxiliary input, no data display	1 lbs	\$39.99
259680	MS-BT200	MS-RA205 and 700 series with data display	1 lbs	67.99

**FUSION 2-WAY COMPACT BOX SPEAKERS**

Item	Model	Description	Ship	Net
259571	MS-OS420	(2) 4", 100 W, outdoor	7 lbs	\$59.99

**FUSION EL SERIES 2-WAY SHALLOW MOUNT SPEAKERS**

Item	Model	Size	Power	Color	Ship	Net
259570	MS-EL602	(2) 6"	150 W	White		\$51.99
261839	EL-F65I	(1) 6.5"	80 W	White or Black	5 lbs	99.99
261840	EL-F65ISPG	(1) 6.5"	80 W	Sport Gray w/LED	5 lbs	120.00

**FUSION XS SERIES 2-WAY SPEAKERS**

Item	Model	Size	Power	Color	Ship	Net
261832	XS-F40CWB	4"	120 W	White or Black	4 lbs	\$119.99
261833	XS-F65CWB	6.5"	200 W	White or Black	5 lbs	169.99
261835	XS-F77CWB	7.7"	240 W	White or Black	5 lbs	199.99
261834	XS-FL65SPGW	6.5"	200 W	Gray or White w/LED	5 lbs	199.99
261836	XS-FL77SPGW	7.7"	240 W	Gray or White w/LED	5 lbs	229.99

**FUSION SUBWOOFERS**

Item	Model	Size	Power	Grills	Ship	Net
261837	XS-S10CWB	10"	600 W	(1) Single speaker, White	10 lbs	\$189.99
261838	XS-SL10SPGW	10"	600 W	(1) Single speaker, White	10 lbs	189.99
260472	SG-S10W	10"	450 W	(1) Single speaker, White	15 lbs	299.99
261699	SG-SL10ISP	10"	450 W	(1) Speaker, White or Chrome with LED	15 lbs	329.99

**FUSION AMPLIFIERS**

Item	Model	Description	Ship	Net
259814	MS-AM702	2 channel 140 W; drive up to 4 speakers (2 ohms)	2 lbs	\$104.99
260652	MS-AM402	2 channel 400 W; drive a subwoofer, an extra pair of speakers or even 4 speakers (at 2 ohms)	7 lbs	219.99
260653	MS-AM504	4 channel 500 W; drive the SW10 subwoofer and up to 2 additional pairs of speakers or drive 2 pairs of speakers for maximum power	9 lbs	319.99
261700	SG-DA51600	Signature Series Marine 5 channel amplifier	11 lbs	599.99





**BOSS RECEIVERS AND PACKAGES**

**MGR450B BLUETOOTH MARINE STEREO RADIO**

- Weatherproof, gauge style multimedia player
- Output: 60 watts x 4 max power
- Plays MP3, WMA, FM / AM, digital media from smartphones
- Compatible with audio out from smartphones and MP3 players
- Play and control music and apps like Spotify / Pandora wirelessly
- Audio streaming
- Auxiliary Input
- Built-in preset EQ
- Fully marinated
- No CD mechanism
- Pre-amp output
- RDS tuner
- USB charging and playback
- Switchable tuner

Item	Model	Description	Ship	Net
261556	MGR450B	Receiver only	3 lbs	\$104.99
261557	MGR420R	Wired remote control*	2 lbs	84.99
261558	MGR25C	Remote extension cable, 25'	1 lbs	34.99

\*4' cable - extension sold separately

**MR762BRGB MP3/CD/AM/FM RECEIVER WITH BLUETOOTH**

- Featuring multi-color illumination options
- Wireless remote
- Single DIN marine Bluetooth enabled CD/USB/SD, MP3, WMA, FM/AM receiver
- Front AUX input; full detachable front panel
- Switchable US and Europe tuner
- USB/SD card slot
- Output power: 60 W x 4 channels
- Wireless remote
- Bluetooth audio streaming
- 4 x 60W
- Wireless APP control, Android APP on Google Play

Item	Model	Description	Ship	Net
260254	MR762BRGB	Receiver only	4 lbs	\$109.99

**MR752UAB MP3/AM/FM/CD MULTIMEDIA RECEIVER WITH BLUETOOTH**

- Single DIN marine Bluetooth enabled CD/USB/SD, MP3, WMA, FM/AM receiver
- Front AUX input; full detachable front panel
- Switchable US and Europe tuner
- USB/SD card slot
- Output power: 60 W x 4 channels
- Wireless remote
- Wireless APP control, Android APP on Google Play

Item	Model	Description	Ship	Net
259987	MR752UAB	Multimedia receiver only	4 lbs	\$104.99
259988	MCK752WB.6	Package with (2) MR6W speakers and antenna	8 lbs	124.99

**MR508UABS SINGLE-DIN CD PLAYER WITH BLUETOOTH AND WIRELESS REMOTE**

- Weatherproof 50 W x 4 max power, balance/fader/bass/treble and preset built-in EQ
- Plays USB/SD, MP3, WMA, FM/AM and smart phones
- USB, SD, aux, inputs, front and rear pre amp outputs
- Make and receive calls; play and control music and apps like Spotify/Pandora wirelessly

Item	Model	Description	Ship	Net
261149	MR508UABS	Receiver only (Silver or White)	4 lbs	\$94.99
261150	MCK508WB.6	White receiver with (2) MR6W speakers	8 lbs	104.99

**SINGLE-DIN MECH-LESS MULTIMEDIA PLAYER (NO CD/DVD) WITH BLUETOOTH**

- Weatherproof 50 W x 4 max power, balance/fader/bass/treble and preset built-in EQ
- Plays USB/SD, MP3, WMA, FM/AM and smart phones
- USB, SD, aux, inputs, front and rear pre amp outputs
- Detachable front panel, wireless remote

Item	Model	Description	Ship	Net
261151	MR632UAB	Receiver only (White)	1 lbs	\$64.99

**MGR350B BLUETOOTH ENABLED (AUDIO STREAMING) IN-DASH MARINE GAUGE DIGITAL MEDIA AM/FM RECEIVER**

- IPX6 rated
- Blue back-lit illumination
- Rear aux-in
- White LCD display
- Rear USB
- AM/FM tuner
- 60W x 4 channels
- Weather band
- Bluetooth® A2DP

Item	Model	Description	Ship	Net
260256	MGR350B	Receiver only	2 lbs	\$89.99
261426	STEWH T MCKGB350W.6	Package with (2) MR6W speakers	7 lbs	116.99

**BOSS SPEAKERS**

**MRGB65 6-1/2" 2-WAY MARINE FULL RANGE SPEAKER**

- Featuring multi-color illumination options
- 200 watts max power
- ABS basket
- Resin impregnated surround material
- RGB-LED illuminated grills allow user to strobe, flash, fade through several colors

Item	Model	Specify Grill Color	Ship	Net
260258	MRGB65	Silver or White	1 lbs	\$69.99

**TUBE PORTABLE MARINE BLUETOOTH SPEAKER**

- USB Charging (USB cable and cigarette lighter adapter included)
- Waterproof IPX 5
- 1800mAh battery
- FM Tuner
- LED Light bar
- Shoulder strap included

Item	Model	Ship	Net
261850	TUBE	4 lbs	\$41.99

**MARINE SPEAKERS (PAIR)**

Item	Model	Size	Peak Power	Freq. Response	Voice Coil	Ship	Net
253250	MR50W	5.25"	150 W	120Hz - 18kHz	3/4" Alum.	4 lbs	\$23.99
259177	MR6W	6.5"	180 W	85Hz - 20kHz	1" Alum.	4 lbs	25.99
253222	MR60W	6.5"	200 W	80Hz - 20kHz	1" Alum.	5 lbs	30.99
253199	MR652C	6.5"	350 W	60Hz - 20kHz	1-1/2" Alum.	7 lbs	59.99
253187	MR752C	7.5"	400 W	40Hz - 20kHz	1-1/2" Alum.	8 lbs	65.99
253218	MR690	6x9"	350 W	60Hz - 20kHz	1" Alum.	8 lbs	57.99



**SONY AM/FM BLUETOOTH MARINE STEREO RECEIVERS**

- 12 VDC
- In-dash single DIN (7" x 2")
- Functions: AM/FM, MP3, WMA, WAV, AAC, FLAC, Bluetooth, USB, AUX, smartphone

Item	Model	Description	Watts	Ship	Net
261055	DSX-M55BT	Stereo receiver, Sirius XM ready	(4) x 55	2 lbs	\$129.99
261346	DSXM5511BT	Stereo receiver with 2 speakers	(4) x 55	7 lbs	169.99
261345	MEX-M71BT	Stereo receiver with CD player	(4) x 55	4 lbs	159.99
261344	MEX-M100BT	Stereo receiver with CD player	(4) x 100	5 lbs	269.99



**SONY MARINE SPEAKERS**

- Hear rich bass and clear vocals with a rigid woofer cone structure
- Hear soaring highs and resounding lows with a wide 45-20000Hz frequency range
- IPX5 certified for marine use
- Sold in pairs (2 per box)

Item	Model	Description	Peak Power	Ship	Net
258948	XS-MP1611	6-1/2" dual-cone speakers	140 watts	3 lbs	\$59.99
259957	XS-MP1611B	6-1/2" dual cone speakers	140 watts	4 lbs	59.99
258949	XSMPI621	6-1/2" 2-way marine speakers	160 watts	4 lbs	129.95

## Marine Receivers, Remotes & Amplifiers



### MRD87i WATERPROOF MARINE RADIO

Poly-Planar's MRD87i radio with concert hall sound now contains Sirius/XM radio, NMEA2000® compatibility, USB connectivity and audio player. Other features include:

- 200 Watt 45Wx4 amplifier
- 2x16 LCD display
- Made for iPod/iPhone/iPad
- SD card reader
- AM/FM/RDS digital tuner
- EQ presets
- NOAA weather band
- 3.5 mm aux. audio input
- SUBWOOFER output
- Powered and line variable
- Cutout is single DIN 7-1/8" x 2-1/8" with 7-5/16 depth clearance
- Face dimensions: 7-9/16" x 3-1/8"



- Remote control interface
- Preset channel memory

Item	Model	Ship	Net
261138	MRD87i	6 lbs	\$289.99

### POLY-PLANAR REMOTE CONTROLS

Item	Model	Description	Ship	Net
258437	MR45R	Wired, waterproof remote control with 6' wire length, For MR45 and MRD80 series	2 lbs	\$64.99
258806	MRR2I	Wireless, floating, waterproof infrared remote control for all Poly-Planar systems, 15' range	1 lbs	\$46.99



### GSMR30 BLUETOOTH MARINE STEREO RADIO

- Waterproof
- Bluetooth audio streaming
- USB-in for music, movie, and photo
- Compatible with audio output of smartphones and MP3 players
- AUX-in
- 1 video output
- 1 subwoofer output
- 1 pre-amp output
- Output power: 4 x 45W
- Easy pairing with auto reconnect
- 18 preset AM/FM stations



Item	Model	Description	Ship	Net
261542	GSMR30	AM/FM, MP3, MP4, JPEG, USB, Smart phone	2 lbs	\$184.99

### GSMR20 GAUGE SERIES MARINE RADIO

- Power: 12 Volt DC
- Output Power: (4) x 45 W
- Functions: AM/FM, MP3, Bluetooth, USB, AUX, Smart phone
- Gauge style, Mount: In-dash
- Cutout: 3.15" Diameter

Item	Model	Ship	Net
261618	GSMR20	2 lbs	\$109.99



### ME-52 AMPLIFIER

- 2-Channel 50 Watt Expansion Amplifier
- For adding additional speakers to an existing system or as a separate zone amp
- Includes separate, panel-mounted, waterproof volume control knob
- Powers up to (4) - 4 ohm speakers

Item	Model	Ship	Net
258805	ME52	2 lbs	\$85.99



### ME-70BT MARINE AMPLIFIER

- Includes remote display keypad
- (4) 45 W audio power out (180 W total)
- Phone / Android charging
- Input: USB music player, AUX input
- 100 meter Bluetooth® range
- NMEA 2000 certified
- Backlit 3-line display with adjustable illumination

Item	Model	Description	Ship	Net
261139	ME70BT	Amplifier and remote display keypad	4 lbs	\$247.99



## Poly-Planar Speakers

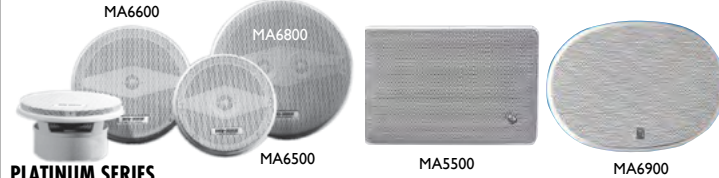

### PLATINUM SERIES

- The first truly waterproof, full-range marine speakers to offer the performance of a home stereo system
- Constructed to withstand the most severe effects of sun and saltwater
- Ideal replacement or upgrade speakers for those who want increased audio power, smooth response and minimum distortion

Color: White powder coated stainless steel grill

Item	Model/Shape	Description	Cone Size	Ship	Net/Pair
251345	MA6500	Round 2-way, 320W (pr)	5-1/4"	8 lbs	\$134.99
251346	MA6600	Round 2-way, 400W (pr)	6-1/2"	9 lbs	164.99
251347	MA6800	Round 2-way, 400W (pr)	8"	11 lbs	189.99
251348	MA6900	Oval 3-way, 400W (pr)	6" x 9"	16 lbs	217.99
259880	MA905-W	Panel 2-way, 400W (pr)	9" H x 6" W x 1" D	8 lbs	\$123.99
251344	MA5500	Panel 3-way, 280W (pr)	10"H x 6-1/4"W x 1-1/2"D	6 lbs	197.99

### TITANIUM SERIES

- Waterproof, ultra-low magnetic field complements any yacht
- 3-way speakers
- Perfect replacement or upgrade of existing speakers
- Magnets will not interfere with navigation equipment

Rated Frequency: 55Hz to 20KHz Color: Black or White

Item	Model	Description	Cone Size	Ship	Net/Pair
259879	MA8505*	Round, 200 W (pr)	5"	4 lbs	\$85.99
255927	MA8506	Round, 200 W (pr)	6"	5 lbs	109.99

### PREMIUM SERIES

- Includes interchangeable White and Graphite colored grills (2) White, (2) Graphite
- 2-way coaxial
- Flush mount
- Waterproof: IP65

Rated frequency: 95 KHz to 20 KHz

Item	Model	Description	Cone Size	Ship	Net/Pair
259877	MA7050	160 W (pr)	5"	6 lbs	\$65.99
259878	MA7065	180 W (pr)	6-1/2"	9 lbs	87.99

### PERFORMANCE SERIES

- Low magnetic field speakers
- Peak power: 80 W (pr)
- Ideal as initial, upgrade or replacement speakers

Color: Black or White

Item	Model	Description	Cone Size	Ship	Net/Pair
251341	MA4054	Round, 2-way	4"	3 lbs	Starting At \$42.99
251342	MA4055	Round, 2-way	5"	4 lbs	52.99
251885	MA4056	Round, 2-way	6"	4 lbs	61.99
255306	MA4600*	Round, dual cone	6"	3 lbs	43.99

\*White only

### GUNWALE SURFACE MOUNT SPEAKER

- Mount these full-sized speakers out of the way under the gunwale where they're protected from the elements
- Delivers rich, full sound
- Molded, one-piece plastic grill protects the speaker components from splash and spray
- Two-way, vented port design offers full range response
- Peak power: 200 W (pr)

Color: White

Item	Model	Size	Ship	Net/Pair
255305	MA9020	10-1/2"H x 6"W x 5-1/4"D	9 lbs	\$85.99



### Compact Box Speakers

- Low magnetic field
- Two-way bass reflex box speakers
- Peak power: 100 W (pr)
- Stainless Steel gimbal bracket included

Specify Color: Black or White.

Item	Model	Dimensions	Ship	Net/Pair
251939	MA800	7-1/2" x 5" W x 5" D	9 lbs	\$99.99



### MA840

- Ideal for locations where other speakers won't fit
- Low magnetic field
- Peak power: 80 W (pr)
- Stainless steel grill and bracket

Specify Color: Black or White

Item	Model	Dimensions	Ship	Net/Pair
251942	MA840	4-1/4" H x 4" W x 4-1/2" D	3 lbs	\$55.99



### MA7500

- Contemporary design
- Low magnetic field
- Peak power: 100 W (pr)
- Stainless steel grill and bracket included

Specify Color: Black or White.

Item	Model	Dimensions	Ship	Net/Pair
254135	MA7500	7-3/4" H x 5-1/8" W x 4-3/4" D	8 lbs	\$114.99



### MA9060

- Stainless steel grill
- Peak power: 200 W (pr)

Specify Color: Black or White

Item	Model	Dimensions	Ship	Net/Pair
253853	MA9060	9" H x 6" W x 5-1/2" D	11 lbs	\$159.99



### COMPONENT SPEAKERS- Ships at 2 lbs

Specify Color: Gray or White

Item	Model	Description	Cone Size	Net/Pair
257701	MA3013	Round, 60 W (pr)	3"	\$38.99
259874	MA50G	Oval, 35 W (pr), Gray only	2"	42.99







**ACX11 USB/AUX ACCESSORY INPUT EXTENSION CABLE**

Item	Model	Description	Ship	Net
261137	ACX11	Waterproof panel/mount, rubber cover, 6.5' cable	2 lbs	\$22.99

**IC 3.5PM MP3 ADAPTER (includes 4' patch cord)**

Item	Model	Description	Ship	Net
255926	IC-3.5PM	Waterproof dash mount, rubber cover, 4' cable	1 lbs	\$13.99

**WATERPROOF DUAL-PORT USB CHARGER**

Item	Model	Description	Ship	Net
259875	USB-PM	Includes 70" wire for powering outlet	1 lbs	\$24.99

**UNIVERSAL RADIO MOUNT**

Item	Model	Description	Ship	Net
256743	RM-10	Under dash or overhead mounting	2 lbs	\$19.99



**BLUETOOTH AUDIOLINK**

- Plug into the auxiliary port on any stereo via 2 - RCA jacks
- A Black and Red power lead must be supplied with DC power

Item	Model	Description	Ship	Net
260654	BTAL-01	Bluetooth Audiolink	1 lbs	\$32.99

**STEREO WEATHER ENCLOSURE & SPLASH COVER**

- Gasketed enclosures to mount stereo in a U-bracket mount
- Fits DIN style, dual post style

Item	Model	Description	Dimensions	Ship	Net
252230	WC400W	White weather enclosure	4"H x 9"W x 7"D	3 lbs	\$49.99
252211	WC3	Splash cover	-	1 lbs	\$19.99
261140	WC4	Splash cover, Black or White	-	1 lbs	\$19.99

**Hailer Horns & VHF Radio Remote Speakers**

**NEWMAR DECK HORN/HAILER/PA SPEAKER**

- Paging, hailing, fog horn and alarm systems
- Audio output: 20W / 30W peak
- Waterproof
- Impedance: 8Ohm

Item	Model	Dimensions	Ship	Net
253486	PA-30/20	9.1" D x 7.9" W x 4.7" H	3 lbs	\$47.99

**STANDARD HORIZON 7" HAILER HORN**

- UV resistant, White ABS plastic for long life
- All stainless steel fasteners
- 4 OHM impedance; 40 W max input

Item	Model	Dimensions	Ship	Net
254148	240SW	5" x 7"	3 lbs	\$44.99

**STANDARD HORIZON ROUND HAILER SPEAKER**

- Economic hailer / foghorn for all of your amplifying needs
- Ohms: 4
- Maximum wattage: 30
- Material: Plastic
- Connector: Bare wire

Item	Model	Dimensions	Ship	Net
251861	220SW	5" round	2 lbs	\$32.99

**POLY-PLANAR REMOTE VHF SPEAKERS**

- Surface mount and waterproof
- Specify: Black or White
- Sold individually

Item	Model	Dimensions	Watts	Ship	Each
252009	MB41	4-5/8" x 4-5/8" x 2-1/8" D	20	2 lbs	\$31.99
251959	MB21	2-15/16" x 2-3/4" x 1-5/16" D	16	1 lbs	22.99

**POLY-PLANAR REMOTE VHF SPEAKER FLUSH MOUNT**

Mount these speakers where you can hear them and keep your VHF radio in an out-of-the way location where it won't get wet.

- Round, flush mount
- Polypropylene cones
- Heavy duty ABS plastic enclosures
- 5" round, 1-1/2" deep
- Plastic grills
- 20 W Max

Please Specify: Black or White

Item	Model	Ship	Net
251340	MA1000-R	1 lbs	\$33.99

**SSB Accessories**

**SHAKESPEARE SSB ANTENNAS**

**Whip antenna with conductors running full-length (no loading coil)**

This award-winning performer is often referred to as the standard of the industry by virtue of its capabilities and popularity.

- Reinforced insulating qualities allow input power up to 1 kW
- Conductors are permanently sealed in Shakespeare White fiberglass
- The Style 393 antenna is electrically the same as the 390 but comes in 3 sections so it can be shipped UPS
- Chrome-plated brass ferrule with standard 1-in-14 thread
- Side feed termination bands
- 2 Sections: Base 162", Tip 112"

Item	Model	Description	Ship	Net
251494	390	23', Deck/side mounted, 2 sections	10 lbs	\$189.99
251495	393	23', Deck/side mounted, 3 sections	90 lbs	274.99

**GUEST Dynaplate GROUNDING PLATES**

Item	Model	Dimensions	Protection	Ship	Net
252162	4006	6" x 2" x 1/2"	12 sq. ft.	2 lbs	\$97.99
252163	4008	8" x 2-1/2" x 1/2"	20 sq. ft.	3 lbs	164.99
252164	4012	12" x 3" x 1/2"	40 sq. ft.	4 lbs	257.99
252165	4018	18" x 6" x 1/2"	100 sq. ft.	12 lbs	559.99

For maximum protection and support of SSB, use 4018 super.

**COPPER FOIL**

Cut to length. This foil has many ham, marine, hobby and commercial applications. Note: Thickness is 3x the standard grounding copper sold elsewhere. Sold per foot.

Item	Description	Ship/Ft	Net/Ft
253129	.003" Thick x 3" Wide	1 lbs	\$1.34

**Lightning Protection**

**FORESPAR LIGHTNING MASTER STATIC DISSIPATER**

- Lowers the exposure to a direct lightning strike by controlling the conditions which trigger direct strikes
- They reduce the buildup of static ground charge and retard the formation of the ion streamers which complete the path for a lightning strike
- The dissipater employs the point-discharge principal to continually leak off the lightning causing ground potential in low amperage dissipation over a long period of time instead of the short duration, high amperage discharge occurring with a lightning strike
- This is the same technology from the same manufacturer which is successfully employed to protect commercial broadcast and television towers from lightning strikes
- Forespar does not claim that this product is 100% effective in preventing a lightning strike

Item	Model	Ship	Net
252171	151100	1 lbs	\$149.99

**Marine Transceiver**

**IC-M802 DIGITAL SSB - NMEA AWARD WINNER**

**Features:**

- Rugged 150 Watt SSB transceiver - HAM ready
- Large dot matrix LCD display
- Built-in digital selective calling
- One touch email access

**System also includes:**

- RC25 Remote controller
- OPC1106 Separation cable
- OPC1107A DC power cable
- Microphone hanger
- ACC plugs
- HMI35 Hand microphone
- SP24 External speaker (Black)
- Mounting bracket kits
- DC power cables
- Spare fuse

**Other Features**

- Wide band receive coverage (0.5 - 29.9999 MHz)
- Remote control mic allows you to select channels directly
- Accessory RS-232C port allows connection of modem, etc.
- GPS input
- NMEA 0183 version 3.01
- A headphone jack in front of the controller
- Wfax (a.k.a. Weatherfax ) capable

**Dimensions:** 9-7/16" x 3-11/16" x 9-3/8" **Voltage:** 13.6 VDC

Item	Model	Description	Ship	Net
254785	IC-M802 11	Digital Single Side Band	20 lbs	\$1899.00

**AT-140 AUTOMATIC ANTENNA TUNER**

- Easily connects to the IC-M802
- Eliminates tedious manual antenna tuning
- Automatically bypasses tuning to improve frequency reception
- Designed specifically for e-mail and shortwave listening
- When the tuner cannot tune the antenna, the IC-M802 bypasses the tuner and displays a warning indicator on the LCD

Item	Model	Description	Ship	Net
254786	AT-140	Automatic digital tuner	7 lbs	\$499.99

**ACCESSORIES**

Item	Model	Description	Ship	Net
254838	SP-24	External speaker: 4" x 4"	1 lbs	34.99
254837	OPC1147N	Icom OPC1147 SSB control cable	2 lbs	69.99

SSB (Single Side Band) radios are used for ship-to-ship and ship-to-shore communications for merchant vessels and yachts to receive weather data, emails, Coast Guard and other authority communications. SSB has also worked where cell phones do not due to lack of tower ability and/or poor signal strength.

**Some things to consider when purchasing a SSB:**

The antenna tuner should be located as close to the antenna as possible. Copper foil should be used to connect the radio to a grounding plate. When two or more foils are to be connected, they should be soldered to ensure a permanent electrical connection. Please call or email us for more information.

# Majestic Global Ultra Slim LED TVs



For more details and specifications please visit [www.defender.com](http://www.defender.com)



## MAJESTIC GLOBAL TV WITH BUILT-IN GLOBAL SOLUTION TUNERS -19", 22" 32"

- ★ Majestic has a range of 12 Volt DC LED TVs using the latest state-of-the-art technology which connect to phones and tablets and are designed to handle the tough outback and harsh marine environment.
- ★ Their engineering team has developed their own power supply stage to handle a large voltage range from 9 V to 27 Volt DC and still perform perfectly without any interruption. The 12 Volt LED TVs are packed with features such as USB for multimedia, they come with up to 2X HDMI inputs, component input, VGA input and much more.
- ★ The MMMI Majestic Multi Media Interface allows your iOS or Android phone to be connected to the Majestic 12 Volt DC LED TV and the TV will act as a large screen, displaying everything on your phone.
- ★ All have built-in DVD Player, PVR on DVB-T Signals, Majestic Link, ARC, USB for Multi Media and MMMI for iOS and Android capable devices to give you full HD video interface.

Item	Model	Description	Ship	Net
261476	LED194GS	18.5" LED TV 12 V with DVD Player, 1x HDMI, USB, MMMI ATSC, DVB-T, DVB-S	9 lbs	\$379.99
261081	LED222GS	21.5" LED TV 12 V with DVD Player, 2x HDMI, USB, MMMI ATSC, DVB-T, DVB-S	11 lbs	459.99
261647	LED323GS	32" LED TV 12 V with DVD Player, 2x HDMI, USB, MMMI ATSC, DVB-T, DVB-S	16 lbs	584.99

Includes 12 Volt DC cigarette 2 M power cable, remote and AC power pack.

## MAJESTIC 12V HDTV AND INTERNET - IN ONE ANTENNA!!

- ★ The UFO XXLW antenna features a 40 dB High gain
- ★ TV amplifier-300% more power than the standard 30 dB antennas.
- ★ There is a WiFi booster in the base, plus a junction box, router with cables and 4 LAN ports, so you can hardwire and get a great TV and WiFi signal throughout the boat. The WiFi router will provide approximately 300 m (984 ft) transmitting distance around the boat, and the WiFi booster will pick up signal from approximately 1000 m (3280 ft) depending on the signal level.
- ★ With the easy to use Android based software, simply log into the router portal, and once locked on you will have reliable WiFi and LAN signal throughout the boat.



### Specifications:

**TV Frequencies:**DVBT, DVBT-2, ATSC, ISDB **Radio Frequencies:** FM& DAB  
**WiFi802:11B:**11M 2.4G 27 dB **WiFi802:11G:**6M 2.4G 26 dB :54G2.4G 24 dB  
**Upload Speed:** 50 Mbps **Download Speed:** 100 Mbps **Voltage:** 10v-28v **In the box:** TV antenna, WiFi booster, junction box, router, 10 m coax cable, 3 m CAT5 cable, and power cables

Item	Model	Description	Ship	Net
261797	UFOXXLW	HDTV / WiFi antenna	3 lbs	\$269.99

### MOUNT AND ACCESSORIES

253316	UFOXJBOX	12 Volt DC junction box for all UFO models	1 lbs	39.99
259759	BKTLA-7C	Wall mount brackets with 2 piece slide 75 mm & 100 mm (15", 19" & 22")	2 lbs	23.99
260013	MJBKTMA007	UFO X mast mount bracket Swing arm 2 piece (mini) Elegant	1 lbs	28.99
261085	ARMLA-55-3	design multi-joint horizontal 180 degree swing Armla-55-3 folds flush	5 lbs	134.99



LIKE US ON FACEBOOK  
[FACEBOOK.COM/DEFENDERINDUSTRIES](https://www.facebook.com/DEFENDERINDUSTRIES)

## TV Antennas

### GLOMEX® 14" DIAMETER SHARK FIN OMNIDIRECTIONAL TV ANTENNA KITS

- Able to receive polarized TV signals both horizontally and vertically
- Fits perfectly with new radome aerodynamic lines
- Reinforced base, coupled with the Glomex micro-fused, electro-polished stainless steel mount (GX-V9172 - sold separately), ensures the best antenna stability
- Able to receive analog and digital signals with automatic tuning for both.



Item	Model	Description	Ship	Net
204944	V9112/12AASY	Antenna with shark fin	4 lbs	\$89.99
205054	V9112AGC	14" TV antenna with auto gain control	6 lbs	109.99
204945	V9172	Angled mount for 10/14" shark fin antenna	2 lbs	25.99

### GLOMEX ALTAIR HDTV ANTENNA DOME WITH AUTOMATIC AMPLIFIER

- Power Supply: 12 / 24 Volt DC, Draw: 25 mA
- Polarization: horizontal / vertical
- Frequency range: 40-890 MHz • Diameter: 10", Lifetime warranty



Item	Model	Description	Ship	Net
205055	V9126AGC	HDTV antenna dome with automatic amplifier	5 lbs	\$139.99

### SHAKESPEARE 2061 SEAWATCH MULTI-DIRECTIONAL FLAT HDTV ANTENNA

- Dimensions: 12" x 13"; Gain: 28 dB; Amplifier: embedded low noise
- Power: AC/DC adapter; Applications: FM / VHF / UHF
- Includes 20' mini coaxial cable (attached to antenna)

Item 260585	Model 2061	Ship 2 lbs	Net \$36.99
-------------	------------	------------	-------------

### SHAKESPEARE 3004 SEAWATCH OMNI-DIRECTIONAL HDTV ANTENNA

- Dimensions: 8" H x 4"; Gain: 30 dB; Amplifier: embedded low noise
- Power: AC/DC USB adapter; Applications: FM / VHF / UHF
- Includes 20' RG-59 coax cable; Mount: 1"-14 threaded

Item 260586	Model 3004	Ship 3 lbs	Net \$99.99
-------------	------------	------------	-------------

### SHAKESPEARE SEAWATCH MARINE TV ANTENNA

- Dimensions: 15" D x 3" H
- Gain: 30 dB; Power: AC/DC adapter
- Applications: FM / VHF / UHF
- Includes F-Connectors, cable

Item 260587	Model 3015	15" Diameter x 3" H	Ship 6 lbs	Net \$129.99
Item 260591	Model 3019	19" Diameter x 3" H	8 lbs	164.99

### SHAKESPEARE ACCESSORIES FOR THE 2020/2025/2030

Item	Model	Description	Ship	Net
260734	4360	TV/AM/FM separator	1 lbs	\$39.99
260735	4364-B	1' extension mast with bag	1 lbs	27.99



## VHF Antennas

### Lifetime Warranty on MANTA-6 VHF MARINE ANTENNA

- Provides both sail and power mariners with a stainless alternative to the large White fiberglass antenna for VHF/FM marine radio.
- Stainless steel 17-7ph whip, housing/UV resistant cap and mounting bracket
- Nickel plated brass whip post
- All connections soldered
- AIS compatible
- No grounding plane needed
- Includes NOAA weather frequencies
- SO-239 connector

Item	Model	Length	Gain	Frequency Range	Power Output	Ship	Net
251126	206	34"	3 dB	156-163 MHz	Up to 250 W	2 lbs	\$59.99
252425	234				Replacement whip for manta-6 VHF antenna	2 lbs	18.99

### SHAKESPEARE® SQUATTY BODY 5215 ANTENNA

- A favorite with sailboat owners, this lightweight, low profile, stainless steel antenna was specially designed for masthead mounting.
- Band: VHF marine band
- Stainless steel whip
- Supplied cable type: None
- SWR: Nominally 1.5:1 at 156.8 MHz
- Stainless steel, L-shaped bracket supplied for mounting

Item	Model	Length	Gain	Max. Input	Ship	Net
251523	5215	3'	3 dB	50 Watts	2 lbs	\$57.99



### GAM ELECTRONICS MARINE ANTENNAS

- Every loading coil is hand wound, factory tuned and tested
- Stainless steel coil housing sealed to prevent moisture damage
- No ground plane required
- Mast mount/side mount bracket available through Defender
- All antennas have stainless steel whips except for the SSB antenna

Item	Model	Description	Ship	Net
250683	SS-2	3' 6 dB VHF antenna whip antenna	1 lbs	\$54.99
254961	Weatherfax/DSC	4.5' weather fax antenna	1 lbs	54.99

### MOUNTS FOR GAM ANTENNAS

Item	Model	Description	Ship	Net
250685	SS-B	Right angle mast bracket	1 lbs	\$5.99

### BOTTOM MOUNT ADAPTERS - FOR USE ON STANDARD MOUNT

Please specify housing/wire color: White/White, Black/Black or White/Black

Item	Model	Description	Ship	Net
260562	ADAP-II	Bottom wire cable exit adapter w/20' RG-58 coax	1 lbs	\$26.99

**SPLIT LEAD SSB ANTENNA** Eliminates the need for backstay insulators. Simply press fit onto your existing backstay wire. Secures with a simple plastic clamp at the base.

Item	Model	Ship	Net
255484	Split lead antenna	8 lbs	\$449.99







## The Newest Marine Satellite TV with Innovative TV-Hub and Easy Installation

With an IP-enabled below decks hub and device-friendly user interface, the four antenna systems of the TracVision TV series are designed for superior TV performance and ease of use on yachts and merchant vessels worldwide.



Visit [defender.com](http://defender.com) to see any KVH rebates running throughout 2019!!!

**ENGINEERED & MANUFACTURED IN THE USA!**

**Solid warranty & technical support**

2 years on parts  
1 year on labor

### TracVision TV1

With its 32 cm (12.5") antenna, the TV1 is ideal for small commercial vessels and pleasure boats that travel primarily along the coast or on inland waterways. A single-cable design and easy-to-use installation wizard and system controls make this antenna a breeze to install and use. DVB-S2 compatible; supports DIRECTV, DISH Network and Bell TV.

- 10-30 Volt DC 42 W nominal
- Includes 1 Power/RF cable (15m / 50')
- Dims: 13.5" Dia. x 13.3" H / 8 lbs

Item	Model	Ship	Net
259977	01-0366-07	46 lbs	\$2195.00

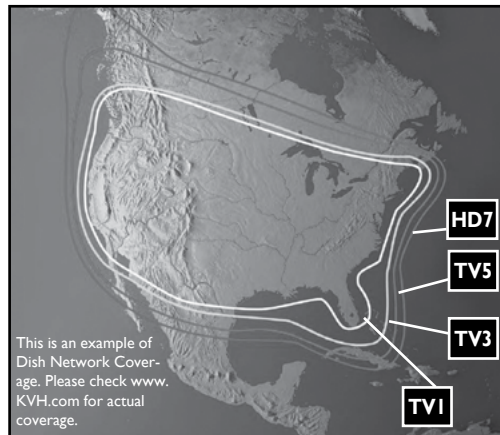

This is an example of Dish Network Coverage. Please check [www.KVH.com](http://www.KVH.com) for actual coverage.

### TracVision TV5

With this high efficiency 45 cm (18") antenna, worldwide regional programming comes right onboard. The rugged TV5 is ideal for commercial vessels, sportfish type and pleasure boats going offshore. DVB-S2 compatible; supports DIRECTV U.S. and Latin America, DISH Network and Bell TV.

- 10-30 Volt DC 53 W nominal
- Includes: (1) Power/RF cable: RG6 (30m / 100'), (3) RF cables: RG6 (30m / 100ft) are optional
- Dims: 19.2" Dia x 20.9" H / 25 lbs

Item	Model	Ship	Net
259979	01-0364-07	104 lbs	\$4495.00

OTHER KVH MODELS AVAILABLE AT [www.defender.com](http://www.defender.com)

### TracVision TV3

With a single-cable installation, the TV3 is a great choice for boats spending time within 100 nautical miles offshore. A compact 37 cm (14.5") antenna and convenient mobile device interface make installation a snap. Use TV3 for single- or multiple-receiver installations. DVB-S2 compatible; supports DIRECTV, DISH Network and Bell TV.

- 10-30 Volt DC 42 W nominal
- Includes: (1) Power/RF cable: RG6 (15m / 50') some configurations may require added cables
- Dims: 15.5" Dia x 17.6" H / 17 lbs

Item	Model	Ship	Net
D 259978	01-0368-07	62 lbs	\$3295.00

### TracVision HD7

Perfect for short or long voyages, the high definition for satellite TV at sea with simultaneous tracking of 3 DIRECTV satellites and no satellite switching!

KVH's 24" TracVision HD7 is a breakthrough in maritime satellite TV design, bringing high-definition programming from DIRECTV® to boats 45' and up. The HD7 simultaneously tracks DIRECTV's Ka- and Ku-band satellites, enables use of digital video recorders (DVRs) and offers the best tracking ever from KVH thanks to patent pending technology including:

- KVH's TriAD technology which simultaneously receives broadcasts from 3 DIRECTV satellites
- Watch, record, and replay with full DVR capability
- IP-enabled antenna control unit (ACU) and iPhone® app
- Antenna dish diameter: 24" (60 cm)
- System power: 100-250 Volt AC, 60 W nominal, 70 W peak

In the box: ACU, power, data, RF cables, ground wire, power inserter, SWM, 4-way splitter and hardware.

- Dims: 26.1" Dia x 27.4" H antenna / 61 lbs
- | Item   | Model        | Ship    | Net        |
|--------|--------------|---------|------------|
| 258026 | 01-0323-01SL | 135 lbs | \$11499.99 |



### Accessories

Item	Model	Description	Ship	Net
260144	19-0618	SWM splitter for DIRECTV	1 lbs	\$46.00
260145	19-0860	DirecTV Ethernet coax adapter (DECA) for automatic satellite switching for multiple receivers	1 lbs	49.99
259982	19-0730	H25 HD receiver with AC adapter and IR remote	8 lbs	134.99
260149	72-0563	RF remote for DIRECTV H25	1 lbs	144.99
260150	72-0634	TV IP autoswitch kit for Dish Network	2 lbs	338.99
260152	19-0747	Router 4 port wireless	2 lbs	214.99

❖ For more detailed product specifications and our complete selection visit [www.defender.com](http://www.defender.com) or call 800-628-8225. ❖

**AN AIS TRANSPONDER** receives information broadcast by other AIS-equipped vessels and base stations, all while your own vessel's static and dynamic information is being transmitted. AIS signals play an important role in navigational awareness. According to current regulations, SOLAS commercial vessels are required to carry a Class A AIS transponder, and commercial, and some recreational racing vessels, require a Class B AIS transponder.

**CLASS B AIS WITH SO-TDMA** technology: SO-TDMA allows AIS transponders to operate more with greater speed, range, and reliability than other Class-B AIS systems. It utilizes a time slot system that ensures every message gets through regardless of radio traffic in the area.

# Raymarine

## AIS700 Class B AIS Transponder with Antenna Splitter

The AIS700 is engineered using the very latest SO-TDMA (Self Organized Time Division Multiple Access) networking technology which allows it to perform faster and at longer ranges and speed over previous generation AIS products. For ease-of-installation, the AIS700 has a built-in VHF-band antenna splitter which allows it to share a single antenna with your current VHF radio. AIS700 also has its own internal, dedicated 72-channel GPS receiver with external antenna as required by international standards.

**Key Features:**

- Built-in AIS/VHF Splitter
- Full transmit and receive AIS for enhanced situational awareness and safety
- Latest SO-TDMA networking for longer range and faster performance
- Built-in antenna splitter simplifies installation with existing VHF radio antenna
- NMEA2000, NMEA0183, PC and SeaTalk<sup>ng</sup> compatible
- Software or hardware switchable silent mode for enhanced security when needed

Item	Model	Description	Ship	Net
261509	E70476	AIS700 transponder	4 lbs	\$999.99



# SIMRAD

## V3100 Class B AIS

The Simrad V3100 Class B AIS is designed to meet the needs of vessels operating in high-traffic areas. It incorporates SOTDMA technology and increased output power to provide improved transmission reliability and range in a cost-effective package for vessels that require greater performance than standard Class B AIS, but do not require a full Class A solution.

**Key features:**

- Enhanced performance compared to standard Class B AIS
- Transmit over greater distances with 5 W output power
- Transmit more frequent position updates with SOTDMA
- Greater transmission reliability in high-traffic areas
- Integrated 'black-box' solution
- NMEA 2000®, dual NMEA 0183®, and USB connectivity
- IP67 water-resistant housing
- Built-in SD card slot for AIS data logging

Item 261728	Model 000-14380-001	Ship 7 lbs	Net \$1049.00
-------------	---------------------	------------	---------------



# SIMRAD

# B&G



## NAIS-500 Class B AIS

Compact in size, lightweight, fully waterproof, with low power draw and featuring multiple connections, the NAIS 500 is ideal for networking with any NSS, NSO, or GO, Zeus or Vulcan series chartplotter / multifunction display and Simrad RS VHF system.

- Compact size; lightweight
- Waterproof to IPX7

- Multiple connection options: N2k, NMEA 0183, USB
- Support for wide voltage range: 9.6 - 31.2 Volt DC
- Low average power consumption: 180 mA at 12 Volt DC
- 50 channel IEC 61108-1 compliant GPS receiver
- Tested to IEC 60945 'Protected' category
- Multiplexed NMEA 0183

Item	Model	Description	Ship	Net
261603	00-13609-001	NAIS-500 with GPS	7 lbs	\$629.99

**MATCHING VHF/AIS/FM ANTENNA SPLITTER**

- NSPL-500 provides unique provision of pre-wired Motorola FM radio connector for direct connection to Navico SonicHub or plug-compatible VHF radio; plug and play

Item	Model	Ship	M.A.P.
261420	000-13612-001	1 lbs	\$249.00

# FURUNO

## Class B AIS Transponder

- Satisfies the standards for Class B AIS, IEC 62287-1
- Receives both Class A and Class B AIS information
- Enhances safe navigation by exchanging critical navigation information from AIS-equipped vessels nearby
- Improves the level of the situational awareness even in fog, darkness or congested waterways
- Flexible integration with AIS compatible radar and chartplotters
- Outputs data to TZZT2, TZZT, NavNet 3D, NavNet vx2 and PC through Ethernet
- Sturdy design mounts easily on a bulkhead



Item	Model	Description	Ship	Net
550209	FA50	Class B AIS transponder	9 lbs	\$995.00
257026	FA30	Class A & B AIS receiver	7 lbs	695.00

# SITEX

## SAS-600/SAS-900 Hybrid AIS with 6" Color Screen



The internationally certified SOTDMA AIS provide 5W of transmit power (vs. typical 2W) for the SAS-600 and 12W of transmit power for the SAS-900 as well as "Class A" transmit priority for enhanced safety even in high-traffic areas. Large clear LCD display with C-MAP chart compatibility let you view AIS targets and data over detailed cartography for professional performance. Receives and decodes all AIS message types and excels at multiple target management. Also features built-in long-range WiFi for use with tablets and remote displays.

- MB and SART alert and tracking systems
- AIS AtoN sensor information displays
- NMEA0183 and NMEA2000 ports to connect gyrocompass, ECDIS and DSC VHF
- IPx6 / IPx7 waterproof
- Ruggedized against shock, vibration and temperature

Item	Model	Description	Ship	Net
261719	SAS-600	Class B AIS, 5 W	6 lbs	\$1249.99
261720	SAS-900	Class A AIS, 12 W	7 lbs	2179.99



## MDA-5

This advanced Class B/S unit transmits at 5 watts - more than twice the power of traditional Class B AIS transceivers - so your boat can be "seen" over long distances and in the most challenging conditions. It also transmits your vessel's position and other dynamic data such as Speed over Ground, Course over Ground and Heading on a more frequent, "Class A Type" priority basis. This provides surrounding vessels with more accurate position information and is especially important for boats traveling at high speeds.

- Hi-power AIS Class B Type: 5W-SOTDMA
- NMEA0183, NMEA2000 and USB connections
- Integrated zero loss VHF antenna splitter - no second antenna needed
- Hi-power WiFi for easy integration with onboard tablets and laptops
- Ruggedized IP67 water, dust and vibration proof
- Small, lightweight and easy to install/mount anywhere
- Hi-fidelity AIS performance
- Low power consumption

Item 261721	Model MDA-5	Ship 3 lbs	Net \$774.99
-------------	-------------	------------	--------------



## Metadata Class B AIS Transponder

Next generation Rmax AIS technology provides state-of-the-art Class B AIS performance in a rugged, compact module. See and be seen with this advanced new SI-TEX AIS solution for any size of vessel.

- Internal 50-channel GPS smart antenna eliminates need for external GPS
- Fully IPx7 waterproof rated and measures only 5.5" x 3.9" x 1.9"
- Designed for plug-and-play integration with chartplotters, radars, onboard PCs
- Built-in NMEA0183 and NMEA2000® interfaces for easy connectivity
- Additional USB interface can be used to power module

Item	Model	Description	Ship	Net
261643PKG	MDA-1	Class B AIS transceiver with external GPS	2 lbs	\$549.99
259097	MDA-3	Metadata VHF / AIS antenna splitter	2 lbs	\$71.99







## MA-500TR Class B AIS Transponder with GPS Receiver

Receives dual AIS channels (channel 87B and channel 88B) simultaneously and receives both Class A and Class B AIS information.

- Individual DSC Call – when connected to a compatible VHF Radio
- CPA and TCPA Collision-Risk management

When a vessel comes into the CPA and TCPA range, the vessel icon blinks on the plotter display and emits a beep sound. When connected to external audio equipment installed on the deck tower, the collision alarm function will alert you even when you are away from the AIS transponder.

- 3-Line NMEA input/output
- Includes 12 channel GPS antenna
- IPX 7 waterproof protection

Item	Model	Ship	Net
260522	MA-500TR	7 lbs	\$589.99



## AIT3000 Nucleus Class B Transponder WITH BUILT-IN ANTENNA SPLITTER AND WIFI INTERFACE

Designed with the latest interfacing capability including NMEA0183, NMEA2000, USB and a WiFi server to allow tablets and iPads to connect – hence the name “Nucleus” as it becomes the hub for on board navigation.

- Data multiplex capability
- Patented ZeroLoss™ technology for the antenna sharing and a wireless interface for iPad connectivity iOS and Android apps available

- NMEA interface plus USB available for chartplotter or computer use
- Silence switch option and output for a FM stereo radio

Item	Model	Ship	Net
260281	ZDIGAIT3000	5 lbs	\$899.99



## AIT1500 Class B AIS Transponder NMEA 0183 AND USB

- Type: Class B transponder with internal GPS
- Power: 12/24 Volt DC

Item	Model	Ship	Net
260402	ZDIGAIT1500	4 lbs	\$539.99



## AIT1500N2K Class B AIS Transponder NMEA 2000 AND USB

- Type: Class B transponder with internal GPS
- Power: 12/24 Volt DC

Item	Model	Ship	Net
261330	ZDIGAIT1500N2K	4 lbs	\$539.99



## AIS Splitter SPL2000

SPL2000 AIS-VHF antenna splitter allows an existing antenna to be used for both the AIS and VHF (DSC) and even with an AM/FM radio. Unlike most simple splitters, it can also be used with a Class B transponder system, and it incorporates special circuitry to ensure safe operation of the two transmitting devices.

Item	Model	Ship	Net
255324	ZDIGSPL2000	5 lbs	\$294.99



Some manufacturers set M.A.P. (Minimum Advertised Pricing) for their products, so we cannot advertise a lower price. However, this does not always apply to selling price. The actual price you will be charged is probably lower. Please call us at 800-628-8225 for further details.

❖ For more detailed product specifications and our complete selection visit [www.defender.com](http://www.defender.com) or call 800-628-8225. ❖



It could save your life



SAFETY UNDERWAY

Collision Prevention



SAFETY AT ANCHOR

Anchor Watch



SAFETY FOR YOUR CREW

Man Overboard

Unlike an ordinary AIS that only sends and receives data, smartAIS transponders from Vesper Marine have built-in safety alarms to alert you of potential collision situations, if your anchor drags or in case of man overboard.

Universal compatibility with all MFDs, WiFi access, NMEA 2000 Gateway, 5 Hz GPS, galvanically isolated ports and smartphone upgradeable AIS platform are just a few of the exclusive features of smartAIS transponders.



## WatchMate Vision2 WiFi smartAIS Transponder

The Vesper Marine XB9010 WatchMate Vision2 AIS transponder is a Class B AIS transponder with NMEA0183, NMEA2000, USB and WiFi. This edition is faster, brighter and easier to use than the previous model (Watchmate Vision 9000) and offers capacitive touch screen and extra WiFi capacity.

- Touchscreen Intelligence with selectable 1 or 5 Hz GPS receiver
- Bright 5.7" color screen
- Intelligent filtering
- Screen magnifier/alarm banner
- Radar plotting screen
- Universal compatibility
- Fully waterproof IPx7
- Compatible with a wide variety of mobile applications, including the new FULL feature Vesper marine Watchmate app. iOS and Android compatible
- Built-in 50 channel GPS antenna
- Safety messages
- DSC calling
- Worldwide coastal outlines
- Galvanic isolated ports
- 10-32 Volt DC, 2W (33dBm transmit power)

Item	Model	Ship	Net
261662	XB9010	2 lbs	\$1150.00



## WatchMate XB8000 smartAIS Transponder

- Black box transponder with built-in smartAIS alarms
- External audible alarm included with the XB-8000 that sounds if it detects a risk in case of potential collisions, dragging anchor or man overboard situations. The alarm sounds even if your MFD or mobile device is switched off

- WiFi access to your transponder anywhere on board
- Use the free Android and Apple WatchMate app configures and monitor
- Free deckWatch app to remote control your transponder using Android Wear 2 smartwatches
- NMEA Gateway translates instrument data to WiFi, USB and NMEA0183 devices
- External 50 channel GPS antenna in the box
- Waterproof IPX7 rating
- Galvanic isolated ports
- Easy integration

Item	Model	Ship	Net
259064	XB8000	4 lbs	\$740.00
261790	XB-8000B1 Bundle (includes splitter & external alarm)	4 lbs	\$949.00



## B6000 AIS Transponder with Built-In NMEA 2000 Gateway

- View AIS on your chartplotter, multi-function display, PC or Mac
- Translates NMEA 2000 navigation data and routes it along with AIS and GPS data over USB to computers or NMEA 0183 to MFDs and chart plotters

Item	Model	Ship	Net
260733	XB6000	4 lbs	\$555.00
261791	XB-6000B2 Bundle (includes splitter)	4 lbs	



## SP160 AIS/VHF/FM Amplified Splitter

- The highest performance splitter which amplifies the AIS signal to significantly increase reception
- Connects an AIS antenna or a shared AIS/VHF antenna to a VHF radio, AIS transponder or receiver and an AM/FM radio
- Improves AIS performance
- 12 - 24 Volt DC
- 2.5 W nominal

Item	Model	Ship	Net
258471	SP160	1 lbs	\$229.00

# Uniden®



### UNIDEN ATLANTIS 270 FLOATING HANDHELD VHF

- New floating design
- Glow seals and power key
- 10 hour battery life
- 1160 mAh high capacity Li-Ion battery pack
- Selectable 1, 2.5 or 6 Watt transmit power
- Display size: 18 mm x 37 mm (0.71" x 1.46")
- "Power Boost" to increase radio performance to higher wattage instantaneously saving your battery in the lower setting and giving you longer range when needed
- Includes AC adapter, DC adapter, belt clip and charging cradle

Item	Model	Ship	Net
Ⓞ 259906	270	2 lbs	\$79.99

### UNIDEN MHS75 SUBMERSIBLE HANDHELD VHF MARINE RADIO

- Compact size, handheld VHF radio
- High capacity Li-Ion battery
- Meets rigid JIS8 submersible standards (5' for 30 minutes)
- Dual, Triple, and Quad Watch Plus
- Selectable 1, 2.5 or 5 Watt transmit power
- All NOAA weather channels with weather alert
- Rapid, clip-on DC charger
- Memory channel scan
- LCD screen displays large, easy-to-read messages
- Up to 12 hours of battery life
- Covers all USA, international and Canadian marine channels keeping you up-to-date with all the latest marine activity
- Includes DC charger, belt clip, wrist strap, Li-Ion battery, antenna

Item	Model	Ship	Net
Ⓞ 257275	MHS75	2 lbs	\$85.99

### UNIDEN MHS126 SUBMERSIBLE FLOATING HANDHELD VHF MARINE RADIO

- Floats to the surface, and its glow-in-the-dark seals and power key allows you to find it easily
- Easy-to-use settings to change between 3 levels of power: 1, 2.5 or 6 watts
- A bright strobe can easily be turned on, flashing SOS
- JIS8/IPX8 waterproof standard: Allows complete submersion of 5 feet for over 30 minutes
- "Power Boost" to increase radio's performance to higher wattage instantaneously saving your battery in the lower setting and giving you longer range when needed
- Includes AC adapter, DC charger, charging cradle, 1160 mAh Li-Ion (12 hour) rechargeable battery, an alkaline battery tray, antenna, lanyard and a heavy duty swivel belt clip

Item	Model	Ship	Net
Ⓞ 259593	MHS126	2 lbs	\$111.99

### UNIDEN MHS335BT SUBMERSIBLE FLOATING HANDHELD VHF MARINE RADIO WITH GPS

- Bluetooth® Wireless – Use SmartPhone to setup radio and TEXT messaging capability
- Full Class D DSC - Meets ITU-R M.493-13, 14, IEC 62238
- Integrated GPS receiver – WAAS, SBAS, QZSS for accuracy
- Auto plot to distress call – using the built-in compass screen
- Water activated MOB feature – take the radio overboard and just press the Distress key
- Water activated emergency strobe light – automatically activates when in water
- Flashlight feature – built-in flashlight
- 6 watt transmit power – transmits at full power to insure maximum range
- Floating radio – radio floats and is rated IPX8 (submersible to 4.9 feet for 30 minutes)
- NOAA weather channels – with Weather Alert and S.A.M.E. local location alerts
- Noise cancel features – for both received and transmitted audio
- Waypoint navigation – navigate to your stored locations using the compass screen
- Smartphone app (android and iOS) – use the setup the radios menu options, enter DSC directory information, TEXT message other VHF radios (text enabled radios) for private communications, update radio firmware
- Includes – AC and DC charging cable, charge cradle, hand strap, belt clip, antenna

Item	Model	Ship	Net
Ⓞ 261635	MHS335BT	2 lbs	\$249.99

# Cobra MARINE™



### COBRA HH150 3 WATT COMPACT VHF RADIO *Cobra's most affordable floating radio!*

- Floats and is waterproof rated at IPX7 standards
- 1,3,5 Watts of power transmission
- Illuminated LCD display and keypad
- Speaker microphone jack allows connection of hands-free accessories (single pin connection)
- Includes DC charger, wrist strap and belt clip
- Also comes with 6 NiMH rechargeable batteries

Item	Model	Ship	Net
261819	MR HH125 Black	1 lbs	\$59.99

### COBRA HH350 FLT FLOATING HANDHELD VHF RADIO

- Floating design and Orange core makes it easily retrieved if dropped overboard
- 6 Watts VHF: Select between 1, 3 and 6 Watts for short and long range communication
- External speaker/microphone jack for hip or body worn operation
- Includes AC and DC adapters, drop-in charger, Li-Ion battery and belt clip
- 8 Hours @ 6 Watts, 16 Hours @ 1 Watts - 5% TX, 5% RX, 90% standby
- 1000 mAh lithium ion polymer rechargeable battery

Item	Model	Ship	Net
Ⓞ 259960	MR HH350 FLT Gray or White	2 lbs	\$94.99

### COBRA HH450 FLOATING ALL-TERRAIN VHF/GMRS VHF RADIO

- Rewind-Say-Again™
- Transmit power: 1, 3 or 6 Watts (marine) and 1, 2 or 3 Watts (GMRS)
- Privacy combinations
- Includes AA battery tray, both AC and DC adapter, spring loaded belt clip
- 1000 mAh lithium ion polymer rechargeable battery

Item	Model	Ship	Net
Ⓞ 259774	MR HH450 Black*	2 lbs	\$122.99

\* Camouflage color available by special order.

### COBRA HH500 FLOATING VHF RADIO WITH BLUETOOTH WIRELESS TECHNOLOGY & REWIND-SAY-AGAIN

- 6 Watts of power selectable in 1, 3, 6 Watts
- Full access to all NOAA weather channels and alarm tones for weather emergencies
- Noise canceling microphone
- Weather alert
- Make and receive phone cell calls using Bluetooth wireless technology
- Rewind-Say-Again; replay missed VHF calls
- Includes AC and DC adapters, drop-in charger, Li-Ion battery, belt clip, etc.
- Includes bonus AA battery tray for using standard AA alkaline batteries
- 8 Hours @ 6 Watts, 16 Hours @ 1 Watt - 5% TX, 5% RX, 90% standby
- 1000 mAh lithium ion polymer rechargeable battery

Item	Model	Ship	Net
Ⓞ 259288	MR HH500 Black	2 lbs	\$134.99

### COBRA HH600 FLOATING VHF RADIO WITH BLUETOOTH WIRELESS TECHNOLOGY & REWIND-SAY-AGAIN

- 6 Watts, floating VHF radio with GPS and Man Overboard
- Make and receive phone cell calls using Bluetooth wireless technology
- Rewind-Say-Again; replay missed VHF calls
- Includes 12 Volt DC and 120 Volt AC chargers; charging stand with contacts

Item	Model	Ship	M.A.P.
Ⓞ 261152	MR HH600 Black or White	2 lbs	\$199.99



**3 YEAR WARRANTY!**



**A. HX100**  
**(Twin pack of floating 2.5 Watt handhelds)**  
 • Slim, form-fitting case design  
 • Selectable 2.5 and 1 W transmit power output  
 • NOAA weather channels and weather alert  
 • US, international and Canadian marine channels  
 • Programmable scan, priority scan and multi watch  
**Material:** Polycarbonate housing **Controls:** 9-button keypad **Antenna:** Flexible whip  
**Dimensions:** 2.32" W x 5" H x 1.34" D **Display:** LCD **Screen size:** 1.5" W x .9" H

**B. HX150**  
**(5 Watt floating handheld VHF)**  
 • Slim, form-fitting case design  
 • Selectable 5 and 1 W transmit power output  
 • NOAA weather channels and weather alert  
 • US, international and Canadian marine channels  
 • Programmable scan, priority scan and multi watch  
**Material:** Polycarbonate housing **Controls:** 9-button keypad **Antenna:** Flexible whip  
**Dimensions:** 2.32" W x 5" H x 1.34" D **Display:** LCD **Screen size:** 1.5" W x .9" H

**C. HX210**  
**(6 Watt floating handheld marine VHF transceiver)**  
 • All USA, international, and Canadian channels  
 • Floating/submersible IPX7 waterproof rating (1M or 3.3 ft. for 30 minutes)  
 • Selectable 6 W / 2.5 W / 1 W output power  
 • High resolution dot matrix LCD  
 • Programmable function keys  
 • High capacity 1800 mAh Li-ion battery  
**Material:** Polycarbonate housing **Controls:** On/Off volume knob, 13-button keypad  
**Antenna:** Flexible whip **Dimensions:** 2.33" W x 5.23" H x 1.85" D **Display:** LCD **Screen size:** 1.5" W x 1" H **Optional:** FBA-42 alkaline battery tray available

**D. HX300 (Compact Floating/Flashing 5 Watt Handheld VHF)**  
 • E2O (easy-to-operate) menu system  
 • Selectable 5 and 1 W transmit power output  
 • NOAA weather channels and weather alert  
 • US, international and Canadian marine channels  
 • Programmable scan, priority scan, dual watch and triple watch  
**Material:** Polycarbonate housing, die-cast chassis **Controls:** On/Off key, 9-button keypad  
**Antenna:** Flexible whip **Dimensions:** 2.32" W x 5" H x 1.34" D **Display:** LCD **Screen size:** 1.5" W x 0.9" H **Optional:** Alkaline battery tray available

**E. HX890 FLOATING 6 WATT CLASS H DSC HANDHELD VHF/GPS** **NEW!**  
 • 2 color options- Black and Navy Blue (4 Code CVS2500A, 32 Code FVP-42)  
 • Switchable daytime/nighttime modes  
 • Group monitor function utilizing DSC Group position call  
 • Meets military standard Mil-STD-810F  
 • 11-hour operating time 1800 mAh battery  
 • Separate receiver for CH70 (receiving DSC calls)  
 • MOB (man over board) function  
 • Oversized full-dot matrix display (2.3")  
 • Noise canceling function for receiver and transmitter audio  
 • All USA/International and Canadian marine channels  
 • Case size: 2.6" W x 5.43" H x 1.50" D (without knob and antenna)  
 • Weight 10.94 (322 g) (with Li-ion battery pack)  
 Includes rechargeable Li-Ion battery, Alkaline battery tray, 110 Volt AC wall charger, 220 V adapter, charging cradle, 12 Volt DC charger, PC programming cable and belt lip with lanyard, and it's backed by our industry leading 3 year waterproof warranty.

**F. HX40 6W Ultra Compact Marine Handheld Transceiver** **NEW!**  
 • Submersible/floating (when fitted into the optional flotation case SHC-29)  
 • Ultra compact case design: 2.05" W x 3.74" H x 1.3" D  
 • 6W / 5W\* transmit power output (selectable 6 / 2.5 / 1W)  
 • 600 mW loud audio output  
 • Preset key used to recall up to 10 favorite channels  
 • CH16/S Quick access (S: Sub-channel-default channel is 9)  
 • Built-in lithium polymer battery pack (7.4 V, 1850 mAh)  
 • NOAA weather channels with weather alert  
 • 3 Year waterproof warranty \* 5W required in some countries  
**Controls:** On/Off key, 9-button keypad **Antenna:** Flexible whip  
**Dimensions:** 2.32" W x 5" H x 1.34" D **Display:** Dot Matrix with backlit display  
 Includes rechargeable lithium polymer battery, AC adapter, DC cable with 12 Volt DC cigarette lighter plug, charger cradle and belt clip, and it's backed by our industry leading 3 year waterproof warranty.

**\$20 REBATE THROUGH 7/31/19**

**M.A.P.** Some manufacturers set M.A.P. (Minimum Advertised Pricing) for their products, so we cannot advertise a lower price. However, this does not always apply to selling price. The actual price you will be charged is probably lower. Please call us at 800-628-8225 for further details.

Item	Model	Color	Watts	Water protection	Floats	Battery type	Battery Life	Weather Alert	Wt.	Included accessories	Ship	M.A.P.
A	259425	HX100	Black	1/2.5	IPX-7	Yes	700 Ni-MH	7.5 hrs	Yes	8.6 oz	110 Volt AC charger, dual charging cradle and belt clips	3 lbs \$119.99
B	259426	HX150	Black	5/1	IPX-7	Yes	1030 Li-Ion	10 hrs	Yes	8.3 oz	110 Volt AC charger, charging cradle and belt clips	2 lbs 89.99
C	261148	HX210	Black	6/1	IPX-7	Yes	1850 mAh Li-Ion	15+ hrs	Yes	9.9 oz	110 Volt AC rapid charger, DC adapter, cradle, belt clip & hand strap	2 lbs Net 99.99
D	258866	HX300	Black	5/1	IPX-8	Yes	1800 Li-Ion	13 hrs	Yes	8.4 oz	12 Volt DC & 110 Volt AC USB chargers, wrist strap, belt clip	2 lbs 129.99
E	261722	HX890	Black/ Navy	6/2/1	IPX-8	Yes	1800 mAh Li-Ion	11 hrs	Yes	10.94 oz	Li-Ion battery, Alkaline battery tray, 110 Volt AC wall charger, 220 Volt AC adapter, charging cradle, 12 Volt DC charger, PC programming cable and belt clip with lanyard	2 lbs Net 199.99
F	261634	HX40	Black	6/2.5/1	IPX-7	*See specs	Lithium polymer-7.4V 1850 mAh	14 hrs	Yes	8.1 oz	Lithium polymer battery, AC adaptor, DC cable with cigarette lighter plug charger cradle, belt clip	2 lbs 119.99

**ACCESSORIES**

Item	Model	Description	HX40	HX100	HX150	HX210	HX300	HX890	Ship	Net
258484	CAT460	VHF marine antenna	•						1 lbs	\$16.99
258485	E-DC-19A	DC cable with cigarette lighter plug	•						1 lbs	28.31
252740	E-DC-6	12 Volt DC cable		•					1 lbs	8.99
259301	FBA-44	Alkaline battery tray					•		1 lbs	21.45
259300	FNB-122LI	1560 mAh Li-Ion battery					•		1 lbs	39.99
260185	SBR-13LI	7.4 V 1800 mAh Li-Ion battery pack						•	1 lbs	42.99
260188	SBT-13	Alkaline battery tray						•	1 lbs	21.99
256221	MH-57A4B	Mini speaker microphone with earphone jack	•						1 lbs	26.99
257337	MH-73A4B	Submersible speaker microphone	•						1 lbs	44.99
260690	SSM-14	Speaker microphone with jack						•	1 lbs	59.99
260691	SSM-55A	Earpiece/microphone						•	1 lbs	29.99
260692	SSM-64A	VOX headset						•	1 lbs	59.99





### WHY CHOOSE ICOM?

Quality is not sacrificed to achieve a lower price point. Every Icom radio is designed to operate in the harshest of environments and is built to MIL-STD 810; Icom is global in communications – Sold in over 80 countries in the world.  
Peace of mind is priceless in an emergency BUT doesn't come free.  
Icom is worth every penny!

### M93D • FLOATING HANDHELD WITH GPS

**Features:** • Slender 2-tone body • GPS built-in providing location, bearing and speed • Class D DSC (Meets ITU-R M494 standard) with a dedicated built-in DSC receiver • Float'n Flash • 5 W with 2.3" full dot matrix display and simple user interface • IPX7 waterproof rating • AquaQuake™ draining function • Active noise cancelling • 50 waypoint memories with alphanumeric name for navigation • Dual/tri-watch function • Battery indicator with 1570 mAh battery providing approximately 9 hours battery life  
**Includes:** • AC adapter BC-123SA\* • Battery charger BC-220 • Battery pack BP-285 • Cigarette lighter cable CP-25H\* • Belt clip MB-133 • Antenna FA-SC59V • Hand strap  
\* May differ depending on version.

Item	Model	Description	Ship	Net
Ⓞ 261125	M93D	Floating handheld with GPS	3 lbs M.A.P.	249.99
Ⓞ 261127	BP285	Replacement battery	1 lbs	99.99
261128	BC220	Rapid charger	1 lbs	58.99

### IC-M25

#### FLOATING VHF HANDHELD IN THREE STYLISH COLORS

The M25 waterproof radio is extremely lightweight, slim and utilizes Icom's popular Float 'N Flash™ functionality. The marine handheld is available in three colors: Metallic Gray, Pearl White and Marine Blue.

**Features:** • Large LCD with simple user interface • AquaQuake draining function • Weather channel with weather alert • IPX7 waterproof construction • Micro USB charging • Up to 11 hours of battery life • Optional microphone speaker (HM-213) • Large backlit LCD and simple user interface • 550 mW audio output • Weight: 7.8 oz • Battery life: Approximately 11 hours • Battery charger: BC-217SA

**Package Includes:** USB charger BC-217SA, antenna FA-SC59V, Belt clip MB-133 and hand strap

**Please Specify Color:** Metallic Gray, Pearl White or Marine Blue

Item	Model	Ship	M.A.P.
Ⓞ 260574	M25	2 lbs	119.99



### IC-M36 • CLEAR VOICE BOOST AND IT FLOATS

Automatically adjusts the outgoing voice and the incoming audio to compensate for the ambient noise level **Features:** • Waterproof construction equivalent to IPX7 (1 m [3.28'] depth for 30 minutes) • 6/1W Dual/Tri-watch functions • 4-step battery life indicator • Weather channel with weather alert • Auto scan function • Instant access to Ch 16 or Ch 9 • Weight: 10.4 oz **Includes:** • Li-Ion battery pack, BP-252-7.4V/980 mAh Li-Ion • Battery life approximately 8 hrs • Battery charger: BC-173 • AC adapter: BC-147SA/BC-174A/E • Belt clip: MB-109 • Antenna: FA-SC58V • hand strap

Item	Model	Ship	Net
Ⓞ 257293	M36	2 lbs	161.99



### IC-M73/IC-M73+ POWERFUL VHF WITH PROFESSIONAL FEATURES

**Features:** • Stylish, ergonomic design with a durable and rugged body • Wide viewing angle, high intensity LCD • IPX8 Submersible Plus™ • Uses a BTL (bridge-tied load) amplifier that doubles the audio output • Internal speaker delivers a loud 700 mW audio output • 6 Watts of transmit power • Large capacity Li-Ion battery allows for 16 hours of operation under normal conditions • AquaQuake water draining function • Dual/tri-watch function for monitoring channel 16 and/or call channel • 4 level battery indicator • Favorite channel and tag scan function • Optional waterproof speaker-microphones, HM-167 and HM-202 • Auto power save function • Weight: 11.3 oz.

#### IC-M73+ also includes:

- Active noise canceling technology
- Last call voice recording
- Cigarette lighter cable: CP-25H
- Battery pack: BP-245N
- Belt Clip: MB103
- AC adapter: BC-123SA/SE (Depending on version)
- Bass boost function
- Rapid charger BC-210
- Antenna FA-S64V
- Hand strap

Item	Model	Ship	Net
Ⓞ 259567	M73	3 lbs	177.99
Ⓞ 259568	IC-M73PLUS	3 lbs	217.99

### Uniden UM385 VHF Marine Radio

Uniden's space-saving 25-watt UM385 VHF marine radio is noted for its full-featured capabilities, affordable price and upgraded design. Full class-D digital-selective-calling capability, including position send, test call, request and text. Receives all U.S., International and Canadian marine channels. NOAA emergency weather alert including S.A.M.E. LCD shows channel names, radio menu, DSC features and GPS data. Meets JIS4 waterproof level, which is splash-resistant. Orange-backlit LCD and buttons. Dual- and Triple-watch modes. Manufacturers three-year warranty. Colors: Black, White. Color: Black. Type: Gimbal mount VHF radios **DSC:** Yes **Water protection:** JIS4/CFR46 **Channel control:** Dual **Scan mode:** Triple **Mic controls:** TX, 16/9 **LCD display:** 23 mm x 46 mm (0.91" x 1.81") backlit **Wattage:** 25/1 **Voltage:** 12 Volt DC **Weather alert:** Yes with S.A.M.E. **Warranty:** 3 years

Item	Model	Description	Ship	Net
261482	UM385	Fixed mount VHF - Black or White	4 lbs	\$97.99

### Uniden UM435 VHF Marine Radio

Uniden's short-chassis, fixed-mount UM435 VHF Marine Radio has been given an upgraded, space-saving design. Meets JIS-7 water-immersion standards (1 meter for 30 minutes). Features include: full class-D digital-selective calling, one-touch distress button, the ability to send and receive position information and Quik Command™ – a one-touch access to Coast Guard channels. High-performance transceiver receives emergency channels and NOAA weather alerts. Full-dot matrix display with intuitive menu. Manufacturer's three-year warranty. **DSC capable:** Yes **Water protection:** JIS-7 **Channel control:** Dual **Scan mode:** Triple **Mic controls:** Up/down, 16/9, Scan **LCD display:** 25.5 mm x 51 mm (1" x 2.01") backlit **Wattage:** 25/1 **Voltage:** 12 VDC **Weather alert:** Yes with S.A.M.E emergency weather alert **Dim:** 7" W x 3" H x 6" D **Warranty:** 3 years **Colors:** Black, White

Item	Model	Description	Ship	Net
261483	UM435	Fixed mount VHF - Black or White	4 lbs	\$107.99



### Sena SPH10

#### Bluetooth™ Stereo Headset/Intercom (2) Unit Package

Brings up four-way intercom conversations featuring a 900-meter (980 yards) range, hands-free calling **Features:**

- Full duplex 4-way intercom conversations,
- Multipoint Bluetooth pairing; fully water resistant; hands-free calling
- Cross-brand intercom compatibility; includes MP3 input

#### Package Includes:

- (2) SPH10 headsets • (2) Boom microphone • (2) Mini microphone
- (2) USB power and data cable (micro USB type) • (4) Rubber ear pads
- (2) Stereo audio cable; 2.5 mm to 3.5 mm

#### Specifications:

Supporting profiles: Headset profile, Advanced Audio Distribution Profile (A2DP), Audio Video Remote Control Profile (AVRCP), Hands-Free Profile (HFP)

**Audio:** • Built-in SBC code • Advanced Noise Control™ • Wind noise reduction

• Wide volume control • Sample rate: 48 kHz (DAC)

• Auxiliary audio-in connection via 2.5 mm jack

**Battery:** • Charging time: 2.5 hours • Talk time: 10 hours • Type: Lithium polymer

Item	Model	Description	Ship	Net
Ⓞ 260878PKG	SPH10-10	Headset package	4 lbs	\$358.20
Ⓞ 260822	SPH10-10	Spare/add-on headset	2 lbs	199.00

### Eartec UltraLITE Full Duplex

#### 4-way Voice Intercom

- No base stations or belt packs
- 4 oz. self-contained headsets

#### Package Includes:

- (2) UL2D - UltraLITE double ear cup headsets
- (2) LX600LI - Rechargeable Li-ion batteries
- CHLX2E - 2-battery multi-port charging base with adapter
- STSSC - Small, soft, padded case

**Audio:** • Standard DECT: 6.0 • Frequency: 1920 – 1930 MHz (USA)

• Euro Frequency: 1880 – 1900 MHz (EURO) • Channel bandwidth: 1.728 GHz

• Modulation type: GFSK • Transmission speed: 1.152 Mbps (baud rate)

• Duplexing: Time Division Duplex (TDD) • Speech encoding: ADPCM / 32bit/s

• RF Accessing Time Division: Multiple Access (TDMA) • 400 m range in open space

**Battery:** • Charge time 3 hours • Operation time 6 hours

• Headset power supply: Rechargeable lithium 3.7 V/ 800 mAh 3.0 Wh

• Charger power supply: AC / adapter: INPUT 110-40 Volt AC

Item	Model	Description	Ship	M.A.P.
Ⓞ 260980	UL2S	Single cup 2-person headset package	3 lbs	\$385.00
Ⓞ 260981	UL2D	Double cup 2-person headset package	4 lbs	425.00
Ⓞ 260982	UL2SD	(1) Single/(1) double cup 2-person headset package	3 lbs	405.00
Ⓞ 260984	UL4D	Double cup 4-person headset package	5 lbs	815.00

Spare/added headsets available as remote or server. Visit [www.defender.com](http://www.defender.com)





**ICOM M330/330G**

- Fixed mount Class D DSC marine VHF series
- Compact size for easy installation
- Entry level radio
- Integrated GNSS/GPS receiver with supplied external antenna (GPS version only)
- Integrated, easy-to-use interface
- Loud speaker with microphone

**DSC:** Yes **Water protection:** IPX7 submersible **Channel control:** Buttons **Scan mode:** Priority and normal **Mic controls:** Up/Down, 16/9 **Display:** Dot matrix **Wattage:** 25/1 **Voltage:** 12 Volt DC **Weather alert:** Yes **Warranty:** 3 year waterproof

**Please specify:** Black or White

Item	Model	Ship	M.A.P.
261631	M330 Without GPS	3 lbs	\$149.99
261632	M330G With GPS	3 lbs	199.99

**ICOM M424G**

Class D DSC VHF with intuitive menu and 2nd station capabilities and built-in GPS. AIS target call with optional MA-500TR Class B AIS transponder. 10 W loud audio, PA, foghorn. **DSC:** Yes **Water protection:** IPX7 submersible

**Channel control:** Buttons **Scan mode:** Priority and normal

**Mic controls:** Full controls **Display:** Backlit LCD **Wattage:** 25/1 **Voltage:** 12 Volt DC **Weather alert:** Yes **Warranty:** 3 year waterproof **Please specify:** Black or White



Item	Model	Description	Ship	Net
260398	IC-M424G	Fixed mount VHF radio with GPS	5 lbs	\$267.99

PLEASE VISIT  
WWW.DEFENDER.COM  
FOR COMPLETE  
SPECIFICATIONS



**ICOM IC-M400BB**

Two-piece, black box configuration. All function control, including DSC operation, can be made from the COMMANDMIC™, HM-195B/SW and the RF unit, IC-M400BB, can be installed in an out-of-sight place. • New, intuitive user interface • 10 W loud audio, public address and foghorn • AIS target call with MA-500TR • AquaQuake Commandmic IV

**DSC:** Yes **Water protection:** IPX7 submersible **Channel control:** Buttons **Scan mode:** Priority and normal **Mic controls:** Full controls **Display:** Dot matrix **Wattage:** 25/1 **Voltage:** 12 Volt DC **Weather alert:** Yes **Warranty:** 3 year waterproof **Please specify:** Black or White

Item	Model	Ship	Net
259569	IC-M400BB	5 lbs	\$339.99

Optional F/M 400BB/M424G black box provides second CommandMic IV capability for the M424 and M400BB.

**ICOM M506**

- Intuitive, menu-driven user interface
- Last call voice recording
- Active noise cancelling
- Built-in horn (automatic and manual)
- AquaQuake™ draining function
- Simple remote control speaker-microphone

**DSC:** Yes **Water protection:** IPX8 submersible **Channel control:** Dual **Scan mode:** Priority and normal **Mic controls:** Up/Down, Hi/Low, 16/9 **Display:** Dot matrix **Wattage:** 25 **Voltage:** 12 Volt DC **Weather alert:** Yes **Warranty:** 3 year waterproof **Color:** Black



Item	Model	Ship	Net
260006	IC-M506 01 NMEA 0183	5 lbs	\$341.99
260007	IC-M506 11 NMEA2K	5 lbs	423.99
260008	IC-M506 31 NMEA2K, Rear mic	6 lbs	464.99
260009	IC-M506 21 NMEA2K with AIS receiver	6 lbs	517.99
260010	IC-M506 41 NMEA2K with AIS receiver, rear mic	6 lbs	554.99

**ICOM M605**

The M605 is a system that allows the user flexibility on how to set up the radio, up to three stations. Boaters can now control up to three controllers using all the M605 functions with the HM-195 series COMMANDMIC™ and/or the RC-M600 Command Head. The full featured M605 also gives customers the option of the radio with an integrated AIS receiver.

**Features:** • 25W output power • 30W listen back hailer • GNSS antenna included • 4.3" wide color TFT LCD • NMEA2000™ and NMEA0183 connectivity • Class D DSC

Item	Model	Description	Ship	Net
261369	M605 11	M605 transceiver with display	6 lbs	M.A.P. \$799.99
261370	M605 21	M605 transceiver with display	8 lbs	999.99
261371	OPC2384	and AIS receiver OPC2384 12 to 8 pin cable for M605	1 lbs	44.99
261372	RCM600	Command head for M605	2 lbs	559.99
260573	HM195GB /W	Icom CommandMicIV Remote Speaker / Microphone / Controller	3 lbs	Starting At 112.00

FOR VHF ACCESSORIES PLEASE VISIT WWW.DEFENDER.COM



**NEW! RAY53, 63 AND 73 VHF RADIOS**



The Ray53, 63 and 73 all have a built-in GPS receiver and also include a connection point for an optional GPS/GNSS antenna. The

optional antenna improves the GPS reception when the radio is mounted below deck, in an enclosed pilothouse, or inside a metal enclosure. All are a full-function VHF marine radio with Class D Digital Selective Calling (DSC) and a built-in GPS receiver. Simply program your boat's MMSI number into the Ray53 and immediately benefit from the enhanced calling and safety features of DSC. All support both NMEA2000 and legacy NMEA0183 networking which enables it to connect with other onboard electronics. The radios also includes both a standard trunnion mounting kit as well as surface mounting hardware.

**RAY53 COMPACT VHF RADIO WITH GPS**

- Compact marine VHF with Digital Selective Calling
- Built-in GPS/GNSS receiver with the optional external antenna connection
- Supports the connection of an optional remote speaker (A80542) to provide audio at a second location

Item	Model	Ship	Net
261804	E70524	4 lbs	\$439.99

**RAY63 DUAL STATION VHF RADIO WITH GPS**

- Full-sized marine VHF with Digital Selective Calling
- Optional RayMic second station kit for full remote control
- Built-in GPS/GNSS receiver with an optional external antenna connection
- Compatible with Raymarine wireless hub and wireless handset
- Supports the connection of an optional remote speaker (A80542) to provide audio at a second location
- Supports dual control stations with the addition of optional RayMic second station kit

Item	Model	Ship	Net
261805	E70516	6 lbs	\$529.99

**RAY73 DUAL STATION VHF RADIO WITH GPS, AIS RECEIVER AND LOUDHAILER OUTPUT**

- Full-sized marine VHF with Digital Selective Calling
- Built-in Automatic Identification System (AIS) receiver
- Loudhailer output for public address and fog signaling
- Optional RayMic second station kit for full remote control
- Built-in GPS/GNSS receiver with an optional external antenna connection
- Compatible with Raymarine wireless hub and wireless handset
- Supports both NMEA2000 and legacy NMEA0183 networking
- Supports the connection of an optional remote speaker (A80542)
- Add the optional hailing horn (M95435) and use your Ray73 to communicate with crewmembers on deck, on the dock, or on another boat
- Supports dual control stations with the addition of optional RayMic second station kit

Item	Model	Ship	Net
261806	E70517	6 lbs	\$789.99

**RAYMARINE CABLES & ACCESSORIES**

Item	Model	Description	Ship	Net
261830	A80542	Passive remote speaker w/2m cable	2 lbs	\$89.99
261831	A80544	Raymic wireless handset	2 lbs	349.99
260297	A80291	5 m handset extension cable	1 lbs	36.99
260298	A80292	10 m handset extension cable	2 lbs	53.99
260299	A80290	15 m handset extension cable	3 lbs	71.99
260300	A80296	400 mm Fisticm adaptor cable	1 lbs	53.99
261807	R70739	Wireless handset adaptor cable	1 lbs	44.99
260840	R70484	Mic clip	1 lbs	5.00



**MAZU GLOBAL SATELLITE COMMUNICATION SYSTEM**

- Global coverage via Iridium Satellite System
- Provides access to email, texting, navigation, forecasts
- Requires mazu App for iPad use (free download)

Enjoy the convenience of all your onshore communication devices when you're offshore with the mazu m2500 Satellite System and mazu™ iPad® app. • Communication, navigation, safety and fishing software with one antenna and one account • Affordable, flexible monthly plans starting at \$39.99 • Dry Dock plan allows you to put your plan on hold for only \$9.95/month but still maintain access to email when you're not cruising.

**Features:**

- mazu™ iPad® app offer easy-to-use graphic interface
- Touchscreen controls make downloading charts, requesting weather forecasts a snap
- Save on satellite costs when near shore or docked with WiFi, cell connections
- Wireless connectivity
- Easy set up with just three pieces of hardware: smart antenna, base unit and keypad
- Power / data cable connects base unit, antenna
- Affordable, flexible, monthly satellite service plans
- Sentry monitoring available, global access

**Package Includes:** ISI-2000 Black Box, IGT-2100 antenna with 30 feet of cable, keypad and ISI power / data cable

Item	Model	Ship	Net
261601	NA28500	5 lbs	\$995.00



iPad not included

# STANDARD HORIZON



VISIT [WWW.DEFENDER.COM/REBATES.JSP](http://WWW.DEFENDER.COM/REBATES.JSP) FOR MORE DETAILS ON STANDARD HORIZON REBATES AVAILABLE THROUGH JULY 31, 2019

### A. STANDARD HORIZON GX1400 & GX1400G

Affordable ultra-compact with the Class D VHF feature that meets the IPX8 submersible waterproof rating of 4.92 feet for 30 minutes, the GX1400 and 1400G are designed for simple installation. The radio's rear chassis is only 5.9" deep for greater mounting flexibility in tight spaces. Features, including DSC test calling and automatic position polling make this a perfect choice for the budget conscious mariner in need of a full featured marine VHF. Other great features include All USA/International and Canadian marine channels, programmable soft keys, NOAA weather with weather alert, programmable memory and priority scan, dual watch and a microphone with clear voice noise reduction technology to eliminate unwanted background wind and engine noise. Transmits a digital mayday including vessel identification, latitude / longitude and time\* to facilitate a prompt rescue. Additional DSC features include individual, urgency, safety, position report and send, DSC test call and auto DSC channel switching. The GX1400G ECLIPSE includes a built-in 66 Channel GPS for automatic communication of your location when the DSC alert is activated, as well as providing position references when communicating with friends or safety personnel.

- Features:** • 25W marine VHF • DSC Class-D • Compact rear case design  
 • WHD 157 x 62 x 100 mm • IPX8 Submersible design  
 • Built-in GPS-GX1400G only • E2O Easy to operate menu system  
 • Standard Horizon clear voice  
 • Bright back light / Dot matrix display • Microphone w/ keys

Item	Model	Color	Description	Ship	M.A.P.
261792	GX1400	Black or White	Eclipse fixed mount VHF	3 lbs	\$149.99
261793	GX1400G	Black or White	Eclipse fixed mount VHF w/ GPS	3 lbs	179.99

### B. STANDARD HORIZON EXPLORER GX1800/GX1850/GX1800G

Mounting a VHF radio has never been easier. The Explorer GX1800/1850 has an ultra thin, compact rear case, but only 3.5" in depth or half the depth of comparable VHF radios on the market. Both models are capable of adding a second station Ram Mic. The GX1800 has NMEA0183 connectivity, while the GX1850 is NMEA2000 connected. The GX1800G is NMEA0183 and has a built-in 66 channel GPS.

- Features:** • Second station RAM Mic compatible • Optional new RAM Mic SSM-70H  
 • Compact rear case design • IPX8 Submersible design  
 • Built-in GPS version available / GX1800G • NMEA2000 version available / GX1850  
 • E2O Easy to operate menu system • Standard Horizon clear voice microphone  
 • Bright back light / Dot matrix display • Microphone w/ keys

Item	Model	Color	Description	Ship	M.A.P.
261794	GX1800	Black or White	Explorer fixed mount VHF	4 lbs	\$179.99
261795	GX1800G	Black or White	Explorer fixed mount VHF w/ GPS	4 lbs	249.99
261796	GX1850	Black or White	Explorer fixed mount VHF/NMEA2000	4 lbs	249.99

### C. STANDARD HORIZON MATRIX GPS GX2000

For mariners with an AIS transponder or black box receiver on-board  
 • Capability to display AIS information if connected to an external AIS • AIS target display: MMSI, call sign, ship name, BRG, DST, SOG and COG • Contact AIS ship to get position request and report functions with DSC when connected to an AIS receiver or transponder  
 • CPA (Closest Point of Approach) with connected optional GPS antenna • 30 Watt PA/ loud hailer with preprogrammed fog signals • ClearVoice noise canceling speaker microphone with channel selection and 16/9 key • Oversized rotary channel knob with push to enter, backlit display and keys • Optional connection for CMP3I RAM 3+ remote microphone with AIS display • Intercom between radio and microphone • Voice scrambler (optional)

Item 252866 Color: Black Ship 5 lbs M.A.P. \$229.99

### D. STANDARD HORIZON MATRIX AIS/GPS GX2200 With an Integrated 66 channel GPS receiver and dual channel integrated AIS.

• Integrated 66 channel WAAS GPS antenna  
 • Integrated dual channel AIS (Automatic Identification System) receiver  
 • AIS / AIS SART target display: MMSI, call sign, ship name, BRG, DST, SOG and COG  
 • 4800 or 38400 NMEA baud rate selection for plotters with 1 NMEA port • 30 Watt PA/Loud hailer with preprogrammed fog signals • ClearVoice noise canceling speaker microphone with channel selection and 16/9 key • GPS compass, waypoint and GPS status pages • Optional connection for CMP3I RAM 3+ remote microphone with AIS display  
 • Intercom between radio and microphone • Voice scrambler (optional)

Item 259881 Color: Black or White Ship 5 lbs M.A.P. \$399.99

### E. STANDARD HORIZON GX6000

**Features:** • Integrated AIS receiver • 3 year waterproof warranty  
 • AIS / AIS SART target display: MMSI, call sign, ship name, BRG, DST, SOG and COG • NMEA2000 and NMEA0183 compatible  
 • Programmable CPA and TCPA collision avoidance alarms • Dual zone 25W PA / Loud hailer with preprogrammed fog signals and listen back • GPS compass, waypoint and GPS status pages • E2O easy to operate menu system  
 • Oversized rotary channel knob with push to enter • Front panel microphone can be connected to rear panel and extended 20 feet using MEK-4 mic extension kit • Capable of connecting two optional RAM4 or four wireless RAM4W • Integrated voice recorder to play back up to two minutes of RX receive audio • Advanced 80dB commercial grade receiver with local/distance attenuator • Integrated 32 code (FVP-42) and 4 code (CVS2500A) voice scramblers

Item 261142 GX6000 with integrated Class B AIS receiver Ship 7 lbs M.A.P. \$499.99

\* Standard Horizon models are backed by an industry leading 3-year waterproof warranty.

Item	Model	Description	Ship	Net
261144	SSM-70H	Ram4 wired remote mic	3 lbs	\$119.99
261145	SSM-71H	Wireless remote mic	3 lbs	119.99
261146	SCU-30	Wireless base station	3 lbs	119.99
261147	SCU-31	GPS smart antenna	1 lbs	99.99
251861	220SW	4 Ohm/30 watt 4.5" round " PA/Hailing	2 lbs	32.99
254148	240SW	Horn speaker 4 Ohm/4 watt 5 x 8" PA/Hailing speaker	3 lbs	44.99

Item	Model	GPS Built In	WX Alert	Remote Mic	Scrambler	Hailer	Intercom	Waterproof Rating	Product Dimensions	Flush Mount Dimensions	Voltage VDC
A 261792	GX1400	Black or White	No	Yes	No	No	No	IPX8	6.1" H x 2.4" W x 3.9" D	5.2" H x 2" W	12
A 261793	GX1400G	Black or White	Yes	Yes	No	No	No	IPX8	6.1" H x 2.4" W x 3.9" D	5.2" H x 2" W	12
B 261794	GX1800	Black or White	No	Yes	No	No	Yes*	IPX8	6" H x 3.5" W x 3.2" D	5.4" H x 2.9" W	12
B 261795	GX1800G	Black or White	Yes	Yes	No	No	Yes*	IPX8	6" H x 3.5" W x 3.2" D	5.4" H x 2.9" W	12
B 261796	GX1850	Black or White	No	Yes	No	No	Yes*	IPX8	6" H x 3.5" W x 3.2" D	5.4" H x 2.9" W	12
C 252866	GX2000	Black Only	Compatible	Yes	Optional	Yes	Yes	JIS-7/IPX7	3.1" H x 7.1" W x 6.3" D	2.6" H x 6.3" W	12
D 259881	GX2200	Black or White	Built-in	Yes	Optional	Yes	Yes	JIS-7/IPX7	3.1" H x 7.1" W x 6.3" D	2.6" H x 6.3" W	12
E 261142	GX6000	Black	Compatible	Yes	Optional	Yes	Yes	JIS-8/IPX8	10" H x 9" W x 7" D	4.3" H x 6.9" W	12

\*when using the SSM-70H RAM mic

Item	Model	Description	GX1400	GX1800	GX1850	GX5500S	GX6000	GX2000 GX2200	Ship	Net
260839	CMP3I	CMP3I Remote station mic (Black or White)							3 lbs	\$109.99
255308	CT-100	23' ext. cable for CMP30/31 (RAM3/RAM3+)							1 lbs	23.16
255683	MLS-300B	External speaker, Black							3 lbs	44.99
255684	MLS-300W	External speaker, White							3 lbs	44.99
255194	MMB-84	Flush mount bracket							1 lbs	16.99
258482	MMB-97	Flush mount bracket							1 lbs	14.58
260527	HC1100	VHF radio dust cover							1 lbs	8.99
260528	HC1600	VHF radio dust cover							2 lbs	8.99
260529	HC2000	VHF radio dust cover							1 lbs	8.99





MR F57

# Cobra

## MARINE™

**3 Year  
Warranty!**

MR F77

### MR F57 & MR F77 FIXED MOUNT VHF RADIOS

#### Features for both MR F57 & MR F77

- Large and bright LCD display  
New 30 mm x 56 mm display
- Rewind-Say-Again® digital voice recorder with 20 seconds of playback
- PA Output PA function for public address to external speaker – 4 Watts and 8 Ohms
- Easy Softkey Operation – Intuitive softkey operation and animated menu structure
- Automatic Radio Check – Checks battery voltage on Tx, RF power output, antenna output and built in SeaTow ARC menu
- NMEA 0183 In and Out – NMEA in for primary or secondary GPS input. NMEA out to display other vessels and their information transmitted by DSC on your chartplotter
- Channel names and ID friendly VHF channel names next to the channel number
- Smart GPS easy connect – Easy plug and play connector for Cobra's "tucked away" high sensitivity GPS sensor
- External alarm capability – Ground sensing output for connecting as an external alarm for waypoint arrival notifications, MOB, etc.
- Same cut-out size; includes flush mount kit

Item	Model	Ship	Net
260386	MR F57B/W With REWIND and PA features	5 lbs	\$141.99

#### Added Features for the MR F77:

- Built in GPS Receiver – Connect the 12 Volt DC (Red and Black) wires and enter MMSI for full setup and operation
- GPS checker and alarm – Continual cross checking between primary and secondary GPS sources. Sounds alarm if a problem with boats chartplotter (or radio)

**DSC capable:** Class D **Water Protection:** IPX8/JIS8 **Channel control:** Keypad

**Scan Mode:** Dual **Mic Controls:** Tx button **LCD display:** Dot matrix LCD

**Wattage:** 25/1 **Voltage:** 13.8 Volt DC **Weather Alert:** Yes

**Dimensions:** 6.25" x 2.25" x 7.127" **Warranty:** 3 Years

Item	Model	Ship	Net
260387	MR F77B/W With built-in GPS receiver	5 lbs	\$164.99

#### CM 300-005 GPS FOR VHF

- Plug and play connector for the MR F57
- Supplies backup GPS data for the MR F77 GPS
- Works as a backup GPS for any vessel

**PLEASE CALL OR VISIT WWW.DEFENDER.COM FOR MORE INFORMATION**

#### MR F45-D FIXED-MOUNT VHF RADIO

- Class-D DSC - Updated to the latest Class-D Digital Selective Calling (DSC) technology
- Submersible - Designed to JIS7 standards
- Noise-canceling microphone blocks background noise for clearer conversations
- Instant access to national all hazards and weather information, 24 hours a day
- 25 Watt VHF

**DSC capable:** Class D

**Water Protection:** IE JIS7/IPX7 **Channel control:** Keypad

**Scan Mode:** Dual **Mic Controls:** Tx button, Channel Up/Down Button, 16/9 Button

**LCD display:** Dot Matrix LCD

**Wattage:** 25/1 **Voltage:** 13.8 Volt DC **Weather Alert:** Yes

**Dimensions:** 6.25" x 2.25" x 7.127" **Warranty:** 3 Years

Item	Model	Ship	Net
258486	MR F45-D White	3 lbs	\$117.99



#### RS40 VHF/AIS RADIO

Simrad RS40 replaces the current RS35 mid-level VHF, updated to comply with EN 301 025 (v2.2.1) which requires a GPS to be integrated in to the radio. It has a new front mountable design for easy installation, and a low profile design to align with style of Simrad MFD's. The connectivity of the RS40 allows seamless integration with a wider Simrad system through NMEA2000 and 0183 networks and let you get a GPS signal redundantly as a safety measure. It has a built-in AIS receiver, large screen with intuitive user interface and features an optional wireless handset with inductive charging.

Get GPS Signals 4 Ways:

- Built-in, external, through your NMEA0183 chartplotter or an external GPS500 antenna
- Built in AIS
- A dual-channel AIS receiver monitors the position of nearby AIS-equipped vessels
- AIS information can be viewed on the RS40's built-in screen, via overlays on your chart or radar screen through a compatible multifunction display

#### Wireless Handset

- Add up to two optional wireless handsets to take your radio anywhere on board
- The HS40 handset was designed as an intuitive portable companion to the RS40
- Each handset duplicates your radio's display and controls, enabling remote access to all key functions
- Multiple stations also allows the RS40 to double as a handy on-board intercom

#### Remote Mountable Fist Mic

- The removable fist mic can be connected to the front or rear of the radio. An optional extension cable allows the radio and mic to be mounted separately

#### Mount From The Front

- Easily removable top and bottom bezels which reveal mounting holes allowing the same style of mounting from the front that is featured on Simrad MFDs

#### Track Buddy

- Track your buddy by automatically requesting the position of another VHF radio by entering the MMSI into your contact list in the VHF, then start tracking

#### Navigation Mode

- Displaying your speed and course by pushing the NAV button
- Man Overboard (MOB) function let you drop a waypoint at the location of the MOB using the MOB button. The RS40 will enter MOB mode to show distance away and direction to get back to the position of the MOB event. This information will also transmit over NMEA2000 to the rest of your network

Item	Model	Description	Ship	Net
261746	000-14470-001	RS40 VHF/AIS/GPS radio	6 lbs	\$619.00
261747	000-14475-001	Wireless handset	2 lbs	179.99
261749	000-11229-001	Speaker	2 lbs	79.99
261754	000-14912-001	Suncover	1 lbs	16.39

# SIMRAD

**NEW!**

# LOWRANCE®

#### LINK-2 FLOATING HANDHELD VHF RADIO

- 1/5W transmit power
- Full Class-D DSC-enabled VHF radio
- Includes Man Overboard (MOB) functionality and storage for up to 300 waypoints
- "Get Buddy" feature allows buddies to receive bearing and distance data from other Link-2 units
- 128 x 128 pixel LCD with adjustable contrast settings
- GPS latitude, longitude (LL) and time display
- Special 3CH key to select your (3) favorite channels
- Distress call button with hinged door
- Flexible dual watch and tri-watch flexibility
- Weather alerts (US only)
- 2-year warranty

**Material:** Polycarbonate housing **Controls:** 8-button keypad **Antenna:** Rubber duck

**Dimensions:** 2.28" W x 5.55" H x 1.57" D **Display:** Backlit dot matrix LCD

**Screen Size:** 128 x 128 pixels

Item	Model	Ship	Net
© 259599	000-10782-001	2 lbs	\$249.99



# B&G

#### B&G FIXED MOUNT CLASS D DSC VHF

Entry Level with NMEA200 connectivity  
High Contrast black-on white display  
Inverted White on Black night mode

- US/CAN/INT
  - FistMic handset
  - Transmit power Hi 23W ±2W  
LOW .08W ±
  - Ports: 1 NMEA2000, 1TX, 1RX NMEA0183,
- In the box: Mounting bracket and knobs, mic clip

Item	Model	Description	Ship	Net
261417	000-13546-001	V20 Fixed mount VHF	5 lbs	\$192.00

**READ THIS!**

Electronics prices change frequently!

Also some manufacturers only allow us to print the MAP (Minimum Advertised Price) in our catalog, even though we may sell for less. Call 800 628-8225 or check our website for our low, current selling prices.

# Raymarine®

## i70s Multifunction Instrument Display with Wind and Depth Transducer

**INCREDIBLE VERSATILITY AND VISIBILITY**

The i70s features a large, ultra-bright 4.1" LCD screen with enhanced LED backlighting for superior visibility day and night. The LCD is optically bonded to the i70s' front window for high contrast and a wide viewing angle. The i70s multifunction instrument is packed full of powerful features but remains exceptionally easy to use. The i70s is compatible with SeaTalk<sup>®</sup> as well as NMEA2000 networking. Its user-selectable data source selection allows for easy integration on multi-sensor networks.

The i70s features a sleek, low-profile design complimenting the latest Raymarine multifunction displays. Each i70s instrument ships with 2 snap-on bezel options in the box featuring the latest Axiom inspired design. Includes Black bezel and sun cover.

### Compatibility Notes

p70 and p70R autopilot controllers have new bezel and sun cover accessories. These new, square-cornered bezels complement the i70s and Axiom multifunction displays, as well as the all-new, matching sun cover.

### Connectivity Notes

The new i70s instrument is equipped with a single SeaTalk<sup>®</sup> connector. When planning an i70s installation or replacing an older i70 instrument, please make sure to use a 5-way SeaTalk<sup>®</sup> connector block or SeaTalk<sup>®</sup> T piece to connect the i70s instrument to a SeaTalk<sup>®</sup> or NMEA2000 backbone.

Item **261115**

Model **E70327** i70s Instrument Display Only

Ship 2 lbs

Net **\$426.99**

Item **261129**

Model **T70226S** i70s Instrument Value Pack

13 lbs

**1179.99**



## iTC-5 Instrument Transducer Converter

- The Raymarine iTC-5 converts analogue transducer signals used in i70, ST70+ and ST70 instrument systems to SeaTalk<sup>®</sup>
- Transducers for speed/temperature, depth, wind and rudder angle can be connected to the one iTC-5 unit, eliminating the need for multiple ST70 pods
- Extended ST<sup>®</sup> systems can support multiple iTC-5 units
- SeaTalk<sup>®</sup> connections at the base of the unit simply connect the iTC-5 unit into the SeaTalk<sup>®</sup> backbone
- Please note the ST40/i40/i50/i60 and ST60+ displays cannot calibrate the iTC-5. Only the i70 has full transducer calibration
- The ST70/ST70+ can calibrate the depth, wind and speed/temp transducers (not rudder)

- If you don't have an ST70/ST70+ or i70 in your system, then the ST40/i40/i50/i60/ST60+ displays must be interfaced directly to the relevant analogue transducers

Item **259256**

Model **E70010**

iTC-5 Instrument transducer converter

Ship 2 lbs

Net **\$235.99**

VISIT [DEFENDER.COM/RAYMARINE.JSP](http://DEFENDER.COM/RAYMARINE.JSP) FOR MORE INFORMATION



Sample  
Cat5 with  
RJ45 Cable

The standard cable/connector of the computer industry that is very low cost but alternatives such as SeaTalk HS and RayNet are preferred connectors in the marine environment.



Sample  
Raynet  
Cable

Raymarine's current generation system that replaces the RJ45 connector with a waterproof, vibration tolerant twist-lock connector that is designed for the marine environment.



A80160

RayNet to  
SeaTalk<sup>®</sup> Adaptor

### RAYNET CABLES AND INSTALLATION ACCESSORIES

Item	Model	Description	Ship	Net
259144	A80007	HS5 Raynet network switch	2 lbs	\$251.99
259211	R70014	RayNet cable pullers (5 pack)	1 lbs	13.99

Item	Model	Connector A	Connector B	Length	Ship	Net
259207	A80162	Raynet (m)	Raynet (m)	100 mm	1 lbs	\$49.99
259206	A80161	Raynet (f)	Raynet (f)	400 mm	1 lbs	53.99
259208	A62361	Raynet (f)	Raynet (f)	2 m	2 lbs	71.99
259209	A80005	Raynet (f)	Raynet (f)	5 m	2 lbs	89.99
259214	A62362	Raynet (f)	Raynet (f)	10 m	1 lbs	117.99
259210	A80006	Raynet (f)	Raynet (f)	20 m	2 lbs	157.99
259180	A62360	Raynet (f)	RJ45 (m)	1 m	1 lbs	53.99
259204	A80151	Raynet (f)	RJ45 (m)	3 m	2 lbs	58.99
259205	A80159	Raynet (f)	RJ45 (m)	10 m	1 lbs	98.99
259212	A80160	Raynet (f)	RJ45 (f)	400 mm	1 lbs	53.99

**READ THIS!**

Electronics prices change frequently! Also, some manufacturers only allow us to print the M.A.P. (Minimum Advertised Price) in our catalog, even though we may sell for less. Call 800 628-8225 or check our website for our low, current selling prices.

### SEATALK<sup>®</sup> CABLES, COMPONENTS AND KITS

Item	Model	Description	Ship	Net
256617	A25062	Seataalk <sup>®</sup> Back Bone kit Consists of: A06031 terminators x2, A06037 backbone cable 20 m, A06036 backbone cable 5 m x2, A06028 T-connector x4, A06049 power cable, Seataalk <sup>®</sup> reference manual	5 lbs	\$230.99
259766	T70134	Seataalk <sup>®</sup> Starter Kit Consists of: A06064 5-way connector, A06031 terminators x2, A06040 spur cable 9'10", A06049 power cable	1 lbs	89.99

Item	Model	Description	Ship	Net
255564	A06064	5-way connector	1 lbs	\$28.99
252366	A06028	T-piece connector	1 lbs	19.99
252323	A06031	Terminator	1 lbs	9.99
256670	A06030	Backbone extender	1 lbs	14.99
257914	A06049	Power cable	1 lbs	19.99

### BACKBONE CABLES

Individual devices connect to the backbone by spur cables that run to T-pieces on the backbone. The backbone carries both data and power to attached devices. The backbone should be sized so that it will run past every location where an NG or NMEA 2000 device might be installed.

252879	A06033	1'3" Backbone cable (400 mm)	1 lbs	Net \$23.99
252880	A06034	3'3" Backbone cable (1 m)	1 lbs	28.99
252881	A06035	9'10" Backbone cable (3 m)	1 lbs	32.99
252882	A06036	16'4" Backbone cable (5 m)	1 lbs	41.99
259631	A06068	29.53' Backbone cable (9 m)	1 lbs	54.99
252883	A06037	65'7" Backbone cable (20 m)	3 lbs	69.99

### SPUR CABLES

Individual devices connect to the backbone by spur cables that run to T-pieces on the backbone.

256609	A06038	1'3" Spur cable (400 mm)	1 lbs	Net \$23.99
256610	A06039	3'3" Spur cable (1 m)	1 lbs	28.99
256611	A06040	9'10" Spur cable (3 m)	1 lbs	32.99
256612	A06041	16'4" Spur cable (5 m)	1 lbs	41.99

### CONVERTER KITS

254238	E22158	Seataalk to Seataalk <sup>®</sup> converter kit	1 lbs	Net \$87.99
259726	E70196	VHF NMEA 0183 to Seataalk <sup>®</sup> kit	1 lbs	87.99

**WORLD'S FIRST  
INSTRUMENT WITH AIS  
INTEGRATION!**



**DAVIS VANTAGE VUE™ WIRELESS WEATHER STATION**

Includes the Integrated Sensor Suite (ISS) which houses and manages the external sensor array and the console which provides the user interface, data display and calculations. These communicate via an FCC certified, license free, frequency-hopping transmitter and receiver which provides greater communication strength over longer distances.

- 3" x 4-3/8" Backlit LCD screen
- Updates every 2.5 seconds
- Wireless transmission up to 1000 ft.
- Records wind speeds 1 mph - 200 mph
- Solar-powered with stored energy backup
- Displays indoor/outdoor temperature, humidity, barometric pressure, wind speed, wind direction, rainfall and more
- 50 on-screen graphs for comparing current and past weather
- 22 alarms to warn of dangers such as high wind, flooding, etc.
- Radio compatible with Vantage Pro2

Item	Model	Ship	Net
255340	6250	7 lbs	\$359.99



**AIRMAR TECHNOLOGY CORPORATION**

**WX SERIES WEATHERSTATION**

Instruments meet a growing need for real-time, site-specific weather information. For applications where true and apparent wind are important, the 220WX is recommended and includes a 10Hz GPS, three-axis solid-state compass, rate gyro and tilt sensors. This model features configurable NMEA0183 and NMEA2000® digital data outputs providing unparalleled versatility for all your weather monitoring needs. Both models offer a truly best-in-class solution at a better price point than any other weather monitoring system on the market today.

- IPX6 waterproof rating
- Wind speed and direction
- Barometric pressure
- Air temperature plus calculated wind chill
- Ultrasonic wind readings
- Optional relative humidity
- Optional heater
- Cable not included. Choose from cables below.



Item	Model	Description	Ship	Net
260909	44-854-1-01	220WX WeatherStation	2 lbs	\$1164.99
260908	44-858-1-01	120WX WeatherStation	2 lbs	744.99

**CONNECTOR CABLES**

Item	Model	Description	Ship	Net
258768	WS2-C02	6.5' NMEA2000 5-Pin male connector	1 lbs	\$66.99
258769	WS2-C06	20' NMEA2000 5-Pin male connector	1 lbs	80.99
258770	WS2-C10	33' NMEA2000 5-Pin male connector	5 lbs	106.99
258771	WS2-C30	100' NMEA2000 5-Pin male connector	5 lbs	173.99

**NMEA 0183/NMEA 2000 COMBINATION CABLE KITS**

258772	WS-CC15	(1) 50' combination cable, splitter box, 3M connectors, (1) 20' DeviceNet cable for connecting to the NMEA 2000 network	6 lbs	230.99
258773	WS-CC30	(1) 100' combination cable, splitter box, 3M connectors, (1) 20' DeviceNet cable for connecting to the NMEA2000 network	9 lbs	279.99



**Fishfinders & Instruments**

**FISHTRAX™ THE GO ANYWHERE, DO ANYTHING, FISH FINDER**

For beginning to experienced anglers looking for affordability and ease of use, the Hawk-Eye/Norcross FishTrax Fishfinders can go anywhere and get you hi-def fishing capability on a convenient 3" display.

**All units provide**

- Easytouch™ user interface makes system setup and adjustment effortless
- Transducer is trollable, boat-mountable, floatable and portable
- Built-in expandability allows addition of accessories
- 2 Year warranty with 24 hour online technical support
- Runs off (4) AAA batteries (not included)

**Included in the box is:**

- Transducer (requires ACC-FS-1659 bracket)
- Operator's manual

**FISHTRAX™ 1 ICON DISPLAY**

The entry-level FishTrax™ 1 has a VirtuView™ ICON LCD screen that depicts sonar data in a series of icons which provide valuable fishing data in an easy-to-understand readout. The battery life of the FishTrax™ 1 is second to none!

- Fishtrax™ Intelligent Sonar delivers precise fish finder reading
- Audible fish alarm signals the presence of fish
- Variablezone™ water temperature sensor
- Weed and rock indicators indicate bottom compositions
- Glare-free Virtuview™ icon LCD display with LED backlight
- Display type: VirtuView™ ICON
- Frequency: 200 kHz
- Beam angle: 20 Degrees

Item	260828	Model	FTIP	Ship	2 lbs	Net	\$79.99
------	--------	-------	------	------	-------	-----	---------



**FISHTRAX™ 1X DOT MATRIX DISPLAY**

For intermediate anglers looking for advanced features to pinpoint optimal fish habitats. It incorporates a VirtuView™ dot matrix LCD screen that can be adjusted to show raw sonar data or FishTarget™ symbols that display fish as icons with a numeric depth readout. This model also includes auto-switching, dual-beam FishTrax™ Intelligent Sonar as well as a 10-level sensitivity adjustment, multi-level depth ranges and auto-zoom bottom tracking that intensifies prey targeting

- Auto Switching Dual Beam Fishtrax™ Intelligent Sonar delivers precise fish finder reading up to 240 ft. with 1/10th precision
- Audible fish and depth alarms signal the presence of fish and changes in water depth
- Variablezone™ water temperature sensor shows water
- Glare-free Virtuview™ dot matrix display with LED backlight
- Display type: VirtuView™ dot matrix
- Frequency: Dual-beam - 200/83 kHz
- Beam angle: 20/60 Degrees

Item	260829	Model	FTIPX	Ship	2 lbs	Net	\$109.99
------	--------	-------	-------	------	-------	-----	----------



**FISHTRAX™ 1C HD COLOR DISPLAY**

Designed for experienced anglers. Incorporates a full-color, high-definition display and has three operating modes: Fish Finder, Data, and Ice-Mode digital flasher.

- User selectable dual beam Fishtrax™ Intelligent Sonar delivers precise fish finder reading up to 240' with 1/10th precision
- Audible fish and depth alarms signal the presence of fish and changes in water depth
- Variablezone™ water temperature sensor
- 100-level sensitivity adjustment, multi-level depth ranges and auto zoom bottom tracking intensifies prey targeting
- Ice-mode digital flasher portrayal fine tunes display for ice fishing
- Glare-free Virtuview™ HD color display
- Easytouch™ user interface makes system setup and adjustment effortless
- Frequency: Dual-beam - 200/83 kHz
- Beam angle: 20/60 Degrees

Item	260830	Model	FTIPXC	Ship	2 lbs	Net	\$171.99
------	--------	-------	--------	------	-------	-----	----------



**FURUNO**

**FURUNO NX300 WEATHER RECEIVER**

Digital Paperless Navtex receiver 8 line, 4.5" monochrome LCD display, H-field loop antenna, 10 meter signal cable assembly, combination power/data cable and standard accessories

- 490/518 kHz Reception - 200-400 nm range from coast station
- 132 message / 28,000 character memory storage capacity
- Optimum station selection based upon position (\*L/L required)
- GPS NMEA0183 L/L position / SOG / COG / BTW data repeater
- RS-232 Data output to personal computer and printer
- H-Field antenna for enhanced reception (no ground required)
- 3 Modes: Message Selection, Message Display, Nav Data Display
- 15 Message categories - User selectable / customized
- Low power consumption and memory back-up w/lithium battery
- Power requirements: 12 - 24 Volt DC, 70 - 250 mA (3W Max.)

The Navtex receiver is the most economical way of monitoring navigational warnings, meteorological warnings, search and rescue information and other data for ships sailing within 200-400 nm of shore. Every incoming message is identified and new messages are read from the high-contrast 4.5" LCD display; no paper is required. However, you can print out the message via a PC. The NX300 consists of the compact, waterproof display and an H-field loop antenna. You can also use the NX300 as a nav repeater by using its NMEA 0183 port to connect it to your GPS or DGPS receiver.

Item	Model	Dimensions	Ship	M.A.P.
254706	NX300	6.9" W x 4.9" H x 3.4" D	7 lbs	\$695.00



**Most orders placed by 4:30pm Eastern time (Monday -Friday) ship the same day!**

**800-628-8225**

**www.defender.com**

WiFi Systems



**NEW!**

**KVH TRACPHONE LTE 1**

Delivering high-performance LTE service faster than 4G for HD streaming and Internet more than 20 miles offshore in the U.S. Now you can enjoy more reliable coverage and faster speeds than your cell phone, from KVH, the No. 1 global marine VSAT communications provider.\* Enjoy streaming fast onboard connections with no throttling thanks to integrated LTE Advanced (LTE-A) enhanced technology. Now your HD streaming and Internet experience offshore is faster than ever.\*\*

High-gain, dual antenna array means a stronger signal for higher speeds with service up to 2x farther offshore than your cell phone.

Enjoy the freedom and confidence of heading offshore knowing you – and your devices – stay connected.

The TracPhone LTE 1 offers extended and unmatched

coverage in U.S. waters that is only possible by combining the strength of two leading U.S. carriers.\*\*\*

With a 10 GB monthly plan and the option to add more data very affordably as you need it, you can do what you want, when you want, wherever you go. (Check with KVH on monthly subscription plan rates.)

The LTE Manager App allows you to customize your onboard Wi Fi, see your data usage, and receive usage alerts via text or email.

\* Euroconsult's Prospects for Maritime Satellite Communications, 2018

\*\* Speed and coverage area will vary based on antenna mounting location; onboard network equipment; position, height of, and distance to cell towers; network congestion; and network type.

\*\*\* Includes KVH-configured SIM card for KVH-supplied dual carrier service (requires KVH airtime activation)

Item	Model	Ship	Net
261724	01-0419	46 lbs	\$1595.00

**DIGITAL YACHT WIRELESS INTERNET**

Digital Yacht's range of wireless internet products include: long range WiFi adaptors that extend the WiFi connection range of your laptop, tablet or phone from typically 20-30 m up to anywhere between 1-4 miles (depending upon conditions) and wireless routers that then allow the long range internet connection to be shared with all mobile devices onboard the vessel.



**LONG RANGE WIFI ADAPTORS**

**WLS10-HIGH POWER WI FI ANTENNA SYSTEM**

- Flagship hi power Wi-Fi connection system with ranges of 4-6 nm\*
- Network interface for router compatibility and easy direct connection with browser interface
- Has a compact, DC powered below-deck mounted 600 mW booster/modem and external, hi-gain (12 dBm) antenna with 10 m (33') low-loss LMR400 coax interconnect cable
- Antenna measures 0.9 m (2.95') and can be supplied with deck, mast and industry standard 1" x 14TPI mountings
- WLS10 modem connects to an onboard PC through a regular RJ45 CAT5 network cable
- Connect to a router and everyone onboard can share long range wireless connection
- Supports 802.11b/g protocols as well as WEP/WPA/WPA2 encryption



Item	Model	Compatibility	Ship	Net
254725	ZDIGWLS10	Windows XP/Vista/7, Mac OS X 10.3 (and higher) and LINUX	9 lbs	\$694.99

\* WiFi range depends on many factors, but Digital Yacht has seen ranges of up to 4-6 NM with this system.



**WL70 WIFI BOOSTER ANTENNA**

- New 802.11n high sensitivity wi-fi modem
- High gain 15dBm omni-directional antenna (1.29m high)
- Will fit to a standard VHF type mount 1" x 14TPI thread (not supplied)
- USB bus powered via integral 5m (15') cable
- Windows XP/Vista/7/8/10 compatible
- Mac OS X 10.4 to 10.10 (Yosemite) compatible
- Compatible with all popular LINUX distributions including Raspberry Pi

Item	Model	Ship	Net
260655	ZDIGWL70	3 lbs	\$179.99

**DIGITAL YACHT TV ANTENNA**

**DVT100 TV ANTENNA**

A high performance, omni-directional TV antenna providing great reception of the latest digital, terrestrial TV signals while afloat. Weighs approximately 2 lbs (0.9Kg). 11" (280 mm) diameter.

- Global reception capability of latest DVB/HDTV signals
- TV and FM radio outlets
- Below-decks mounted amplifier with -7 db to +29 dB gain control
- Pole or standard 1"x14TPI adaptor mounting capability
- Supplied with 10 m (33 ft) coax
- Optional dual TV outlet amplifier (shown but not included)



Item	Model	Ship	Net
260570	ZDIGDTV100	4 lbs	\$179.99



Some manufacturers set M.A.P. (Minimum Advertised Pricing) for their products, so we cannot advertise a lower price. However, this does not always apply to selling price. The actual price you will be charged is probably lower. Please call us at 800-628-8225 for further details.

**MBR 500 & MBR 550**

The MBR 500 has an internal access point and is a Multi-Source Failover Router. This means that it can manage multiple sources at a time as well as produce the wireless signal to distribute the data to wireless devices. The MBR 500 will give you the ability to manage these sources from one easy to access browser based page. From this page you can manage any additional Wave WiFi devices such as access points and receivers, as well as third party satellite, or cell devices. With our MBR 550 you will enjoy the ability to travel with cell functionality built in. The 550 comes with a SIM slot for SIM activated Cell Data, and has all the other great features of the MBR 500.

The MBR 550 features:

- (2) Access Point antennas (2.4GHz)
- (1) 12VDC Power Adapter
- (1) Quick Start / Configuration Guide
- (2) Cellular Paddle antennas
- (1) SIM slot

Item	Model	Ship	Net
261896	MBR500	4 lbs	Call for Pricing!
	MBR550	4 lbs	



**YACHT AP WIRELESS ACCESS POINT**

Easy-to-install and configure Wi-Fi Access Point on both large and small vessels. The low profile 12" diameter is compact yet rugged and easy-to-install using 12V or 110 PoE. The Yacht AP operates at 802.11 b/g/n and has WPA2 encryption for security. Provides 500 mw of power output with 2 built in antennas for MIMO WiFi connectivity. Works seamlessly with all Wave WiFi products including its MBR series routers and high power EC series units.

Item	Model	Ship	Net
253845	Yacht AP	2 lbs	\$224.99



**ROGUE WAVE BY WAVE WIFI**

A compact wireless bridge and Ethernet converter with an incredible 800 mW output power. Featuring a user-friendly proprietary web based interface. Like all Wave WiFi products, the Rogue Wave is an Ethernet converter (EC), so a direct connection can be made to any other Ethernet enabled device. Perfect for wireless internet access on smaller inshore boats and RV's when connected to a laptop or PC, or when coupled wirelessly with Wave WiFi's Yacht AP Wireless Access Point.

Item	Model	Ship	M.A.P.
253141	ROGUEWAVE	3 lbs	\$335.99



**STAINLESS STEEL ROGUE PRO**

Provides better performance in a more attractive impact-resistant casing than the Rogue Wave. The Rogue Pro is a more robust marine-grade product packaged in a polished Stainless Steel marine-grade weather resistant housing (mount not included). The Rogue Pro makes it the ideal "personal" Ethernet converter/wireless bridge for boat captains and crew when directly connected to a laptop or PC, or when coupled wirelessly with Wave WiFi's Yacht AP Wireless Access Point.

Item	Model	Ship	M.A.P.
259455	ROGUEPRO	4 lbs	\$420.99



**THE MOST COMPLETE LINE OF ANTENNAS AND ACCESSORIES IN THE MARKET**

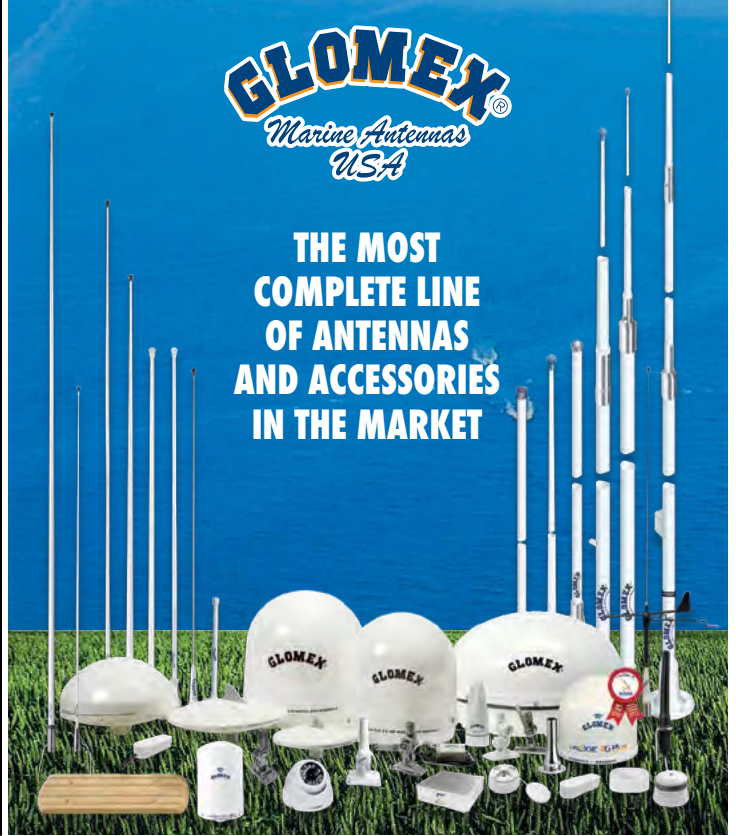





## B&G Triton²/Simrad IS42 Color Digital Instruments

A multi-purpose sailing instrument and autopilot display featuring a 4.1-inch, 320 x 240 pixel, color screen, optically bonded for zero condensation and featuring transreflective LCD technology for exceptional contrast and visibility in all lighting conditions. White LED backlit. 8 mm mounting height matches other Simrad MFD's and system components. With the addition of a Triton²-IS42 Pilot keypad the instrument becomes a fully functional Pilot controller.

### Key Features

- Optically bonded 4.1-inch color display
- Display wind, speed, depth, engine data, autopilot status and more (sensors required)
- Intuitive operation
- Easy installation
- Add an OPI2 keypad for full Simrad autopilot control
- Compatible with Simrad AC12, AC42, NAC-2 and NAC-3 autopilot computers
- Low-profile glass helm design
- Low 1.8 watts power consumption (maximum)
- Advanced AIS, receive AIS messages and call DSC targets (compatible VHF required)
- Certified NMEA2000® connectivity
- Speed & depth packages include display, DST800 transducer, and backbone starter kit (Includes network power cable, 4.5 m (15 ft) N2K cable, 3 x T-connectors, 2 x network terminators)
- B&G speed, depth & wind package includes display, DST800 transducer, wind sensor, 20 m mast cable and backbone starter kit (includes network power cable, 4.5 m (15 ft) N2K cable, 3 x T-connectors, 2 x network terminators)

B&G				
Item	Model	Description	Ship	Net
261062	000-13294-001	Triton² Digital display	2 lbs	\$549.00
261063	000-13299-001	Triton² Speed, Depth & Wind package	10 lbs	1399.00
261064	000-13298-001	Triton² Speed, Depth package	6 lbs	949.00
261065	000-13296-001	Triton² Controller for autopilot	1 lbs	269.00
SIMRAD				
261068	000-13285-001	IS42 Digital display	2 lbs	\$549.00
261075	000-13293-001	IS42 Speed, Depth package	5 lbs	949.00
261069	000-13287-001	OPI2 Controller for autopilot	1 lbs	269.00
260550	000-12316-001	WR10 Wireless controller with base	2 lbs	M.A.P. 349.00

## Simrad IS42J J1939 Gauge and Gateway

4.1" color display that offers a clear view of engine status and performance for up to two J1939 diesel engines. More than a standalone gauge, the IS42J also bridges the gap between those engines and your boat's NMEA2000® network. This enables engine monitoring from other Simrad gauges and displays.

### Key Features

- Bright, optically bonded 4.1" color display
- Monitor up to two J1939 connected engines
- Built-in J1939 to NMEA2000® gateway
- Intuitive operation with waterproof silicone keys
- Easy to install and configure
- Low-profile glass helm design
- Displays and converts many J1939 SPN's
- Configurable data types for digital values and sidebars
- Fuel usage and fuel economy monitoring



Item	Model	Description	Ship	Net
261782	000-14479-001	IS42J Digital gauge	2 lbs	\$799.00
261783	000-12631-001	Track engine harness	1 lbs	125.00
261784	000-14040-001	Caterpillar J1939 adapter harness	1 lbs	95.00
261785	000-14039-001	Yanmar J1939 adapter harness	1 lbs	39.00
261786	000-14376-001	NMEA2000 Medium duty cable, 2 m	1 lbs	47.99
261787	000-14377-001	NMEA2000 Medium duty cable, 6 m	2 lbs	62.00
261788	000-14378-001	NMEA2000 Medium duty cable, 10 m	2 lbs	87.00
261789	000-14379-001	NMEA2000 Medium duty cable, 20 m	3 lbs	99.00

## FURUNO



## Furuno FI-70 Instruments

Furuno's professionally designed FI70 instrument series is designed to meet the needs of sail boaters and power boaters alike.

- The FI70BW package offers a solution to boaters looking for an economical solution to display wind speed and direction
- The FI70DSW package offers a solution to boaters looking for an economical solution to display water depth and vessel speed as well as wind speed and direction
- The FI70 is the perfect add-on to the package to give additional amazing user interface - almost anything can be customized. Conveniently choose the way you want information to be displayed, in a way that is most relevant to you

**FI70BW package** consists of the FI5001 wind sensor and FI70 digital data display.

**FI70DSW package** consists of the FI5001 wind sensor, DST-800PSF digital depth/speed/temp sensor, and two FI70 digital data displays

**Both packages include** the IF-NMEA01 Analog-NMEA2000 converter as well as the FI5002 junction box for a simple installation and full compatibility with other navigation equipment. Whether you use these instruments by themselves or as a part of your NavNet system, the FI70BW will add both function and beauty to your helm.

The FI5001 in both packages, is an analog wind transducer capable of detecting wind angle accuracy of better than  $\pm 10^\circ$  and wind speed accuracy of better than  $\pm 5\%$  (20 kt). Apparent wind direction is displayed on the FI70 display.

Item	Model	Description	Ship	Net
260696	FI70BW	FI70BW Basic wind package	10 lbs	\$1195.00
260695	FI70DSW	FI70DSW Depth/speed/wind	3 lbs	1895.00
260489	FI70	4.1" Color LCD instrument / data organizer	3 lbs	495.00



## Depth Sounders



Euro Black

Chesapeake White SS

Chesapeake Black SS

## Faria Depth Sounders

- Depth range: 61 meters (199 feet)
- Automatic gain control
- Deep and shallow water alarms
- Metric or US standard units
- Back lighting for maximum night vision
- All models feature a 2" dial and require a 2-1/16" cutout

Please specify: In-hull or transom mount transducer

Item	Description	Ship	Starting at
300863	Euro Black	2 lbs	\$139.99
300866	Chesapeake White SS	3 lbs	131.99
300867	Chesapeake Black SS	2 lbs	131.99

SEE PAGE 29 FOR GPS SPEEDOMETERS

READ THIS!

ELECTRONICS PRICES CHANGE FREQUENTLY!

Also some manufacturers only allow us to print the MAP (Minimum Advertised Price) in our catalog, even though we may sell for less. Call 800 628-8225 or check our website for our low, current selling prices.

# Raymarine®



To satisfy any of your vessel's instrument requirements, Raymarine provides everything from the compact but powerful i40 to the high-end, large screen i70s.

For information on the i70s series instruments, please go to page 246.

## i40 Instruments

- Red backlighting for improved visibility
- Large controls for ease of use at sea
- Low power consumption for increased battery life
- SeaTalk interface (SeaTalk<sup>®</sup> when used with SeaTalk converter)
- Built-in transducer interface
- Same footprint as the older Raymarine ST40 instrumentation

Item	Model	Description	Ship	Net
259368	E70063	i40 Speed Display	2 lbs	\$171.99
259369	E70140	i40 Speed System w/Thru-Hull Transducer	4 lbs	251.99
259370	E70141	i40 Speed System w/Transom Mount Transducer	4 lbs	251.99
259371	E70066	i40 Bidata Display	2 lbs	197.99
259372	E70145	i40 Bidata System w/Thru-Hull Transducers	6 lbs	349.99
259374	E70064	i40 Depth Display	2 lbs	171.99
259375	E70142	i40 Depth System w/Thru-Hull Transducer	4 lbs	244.99
259376	E70143	i40 Depth System w/Transom Mount Transducer	5 lbs	274.99
259377	E70065	i40 Wind Display	2 lbs	171.99
259378	E70144	i40 Wind System w/ RotaVecta Transducer	4 lbs	394.99



## i50 Instruments for Power & Sail Boats/i60 Instruments Sail Boats

- Large numerals and digits (analog for the i60) • Red backlighting for improved visibility
- SeaTalk and SeaTalk<sup>®</sup> interfaces • NMEA 2000 (compatible) interface
- Built-in transducer interface • Includes suncover
- 110 mm x 115 mm (4.33" x 4.53") footprint identical to older Raymarine instruments

Item	Model	Description	Ship	Net
259379	E70058	i50 Speed Display	2 lbs	\$336.99
259381	E70060	i50 Tridata Display	2 lbs	493.99
259383	E70059	i50 Depth Display	2 lbs	337.99
259385	E70061	i60 Wind Display (Analog)	2 lbs	449.99
259386	E70062	i60 Wind Display (Analog Close Hauled)	2 lbs	381.99

## i50 & i60 Instrument Package

The i50 / i60 Speed/Depth and Temperature Package includes:

- (3) Displays: (1) i50 Depth, (1) i50 Speed and (1) i60 Analog wind
  - (1) P19 transducer (M78713-PZ-A) and 45 feet of cable
  - (1) ST800-P120 transducer (E26031) and 45 feet of cable
  - (1) Short arm masthead wind transducer (E22078) and 98.4 feet of cable
- Note: No other SeaTalk<sup>®</sup> cables are included

Item	Model	Description	Ship	Net
259422	E70153	i50 / i60 Instrument combo pack	17 lbs	\$1179.99
259380	E70147	i50 Speed System with thru hull transducer	5 lbs	393.99
259382	E70149	i50 Tridata System with thru hull transducers	7 lbs	635.99
259384	E70148	i50 Depth System with thru hull transducer	5 lbs	421.99
259387	E70150	i60 Wind System with thru hull transducer	8 lbs	869.99

## Wireless Performance Sailing Gateway and Bundle Packs

### Micro-Talk™ Wireless Performance Sailing Gateway

Raymarine's new Micro-Talk Wireless Performance Sailing Gateway seamlessly joins together wired and wireless systems, enabling you to achieve all-new levels of high performance sailing!



E70361

Benefits include:

- Performance sailing with wireless wind enhancement on your Raymarine MFD; with accurate lay lines
- Use the power of your Raymarine MFD to inspire enhanced competitive sailing
- True wind achieved with sophisticated airflow and yaw algorithms
- Provides real-time data with robust and fast refresh rate
- Mast rotation position sensing, for wing sail boats
- Quick installation, light and wireless connection to wind vane

Use the Raymarine wireless, ultra-light, solar-powered transmitters with the i60, i70 and i70s instrument systems. When used in conjunction with the optional Raymarine Wireless Mast Rotation Sensor, the system can also provide ultra-precise wind information onboard sailing craft with rotating masts, including winged sailboats. Mast rotation angle is also transmitted to Raymarine LightHouse II (v17) multifunction displays. Enjoy LOW power draw when used with Raymarine solar-powered wireless devices

For other Raymarine wireless systems, visit our website at [www.defender.com](http://www.defender.com).

Component Description	Package Name	Model	i60 Wind	Wind for ST <sup>®</sup> g	Wind with heading	i70s Wind	i70s Wind	i70s Vertical Wind	Microtalk Gateway
			261280	261281	261282	261283	261284	261285	261286
Micro-Talk Wireless Performance Sailing Gateway		E70361	X	X	X	X	X	X	X
Wireless Masthead Transducer		T120	X	X	X	X	X		
		T222						X	
Multifunction Wireless Remote Display		T113	X	X	X	X	X		
DST800 Depth, Speed, Temperature Plastic Through Hull Transducer		A22111				X	X	X	
i70s Multifunction Color Instrument Display		E70327				X	X	X	
Evolution™ EVI Heading Sensor		E70096			X		X	X	
i60 Wind Instrument Display		E70061	X						
SeaTalk <sup>NG</sup> Power Cable		A06049	X		X	X	X	X	
SeaTalk <sup>NG</sup> 5-Way Block		A06064	X		X	X	X	X	
SeaTalk <sup>NG</sup> Network Terminator (x2)		A06031	X		X	X	X	X	
SeaTalk <sup>NG</sup> T-Connector		A06028	X		X	X	X	X	
SeaTalk <sup>NG</sup> Backbone Cable (5M)		A06036	X		X	X	X	X	
Ship			5 lbs	4 lbs	6 lbs	9 lbs	10 lbs	14 lbs	2 lbs
Net			\$1596.99	\$975.99	\$1592.99	\$1773.99	\$2235.99	\$3129.99	\$269.99



## NavPilot 300

The NavPilot 300 outboard autopilot, with Fantom Feedback has a streamlined, simplified installation that no longer requires use of a physical rudder feedback unit. Combined with Furuno's unique adaptive learning technology, NavPilot 300 provides unmatched outboard autopilot performance. The NavPilot 300/PG includes the PG700 fluxgate compass heading sensor with magnetic field distortion correction, providing highly accurate and stable heading information. Fantom Feedback is designed for planing and semi-displacement outboard vessels from 24 to 50 feet, with one to four outboard engines, where it achieves precise course control from slow trolling to speeds of well over 60 knots and the revolutionary Gesture Controller is a revolutionary offers a unique way to steer your boat remotely. Using Bluetooth signals, control the Autopilot from anywhere on the boat within 10 meters. Just push, hold the button, point to the desired heading, and release to let the Autopilot redirect the boat! Feature-rich including the Fish Hunter feature that can also be used for Man Overboard (MOB), this autopilot has it all!



Item	Model	Description	Ship	Net
261670	NAVPILOT 300	Autopilot for outboard engines	15 lbs	\$1275.00
261671	FAP-3011	Control head	30 lbs	495.99
261672	GC001	Spare gesture controller remote	1 lbs	234.99

## SI-TEX

Since 1975, SI-TEX Marine electronics has been a world leader in marine electronics and innovation and has long been the choice of professionals around the world. SI-TEX offer a full line of premium quality marine electronics systems including radars, navigation systems, VHF radios, fishfinders, autopilots, AIS and more products that have proven their performance and reliability in the harsh marine environment. Unmatched in product knowledge and old-fashioned personal customer service make Si-Tex a great boater's choice!

Item	Model	Control Head Type	Rudder Feedback	Compass	Vessel Size	Steer to Wind	Heading Output	Feature Benefits	Ship	Net
261702	SP110C-RF-1	4.1" x 4.1" Fixed mount, color LCD push button	Yes	9 Axis	up to 15m (49')	with wind sensor	with sensor	Includes SP110 color system w/ 9 Axis compass, rudder feedback, no drive unit	5 lbs	\$1594.99
	SP110C-RF-2	4.1" x 4.1" Fixed mount, color LCD push button	Yes	9 Axis	up to 15m (49')	with wind sensor	with GPS	Includes SP110 color system w/ 9 Axis compass, rudder feedback & 12CI reversing hyd. pump	12 lbs	1904.99
	SP110C-RF-3	4.1" x 4.1" Fixed mount, color LCD push button	Yes	9 Axis	up to 15m (49')	with wind sensor	with GPS	Includes PI 10 color system w/ 9 Axis compass, rudder feedback & "Type S" dash drive	14 lbs	2294.99
	SP110C-RF-4	4.1" x 4.1" Fixed mount, color LCD push button	Yes	9 Axis	up to 15m (49')	with wind sensor	with GPS	Includes SP110 color system w/ 9 Axis compass, rudder feedback & "Type T" dash drive	15 lbs	2374.99

### DRIVES & 2ND STATIONS

Item	Model	Description	Ship	Net
258593	81167	Hydraulic pump 18CI for SP-70/80	8 lbs	\$399.99
258594	81783	Hydraulic pump 30CI for SP-70/80	10 lbs	479.99
258713	I0080035	2nd station for SP70 above with 30' bulkhead connector	3 lbs	419.99
258714	I0080038	2nd station for SP80 above with 25' cable	2 lbs	499.99

## Octopus Type R Remote Drive System

For both single or dual engine systems. The installation kit simply clamps to the steering cylinder with no drilling or cutting required. Two packs are available to suit the most common Mercruiser and Volvo-Penta sterndrive systems. These drives include the connection kits and steering cables. Add the appropriate rudder feedback shown below. The drives are supplied with a 6' cable (single engine). Optional 9' cable available by special order for dual engines.

Item	Model	Description	Ship	Net
260408	OCTAFMDRESYA	Choose one of the Sterndrive system models below Mercruiser from 1994, North American Volvo from 1997	17 lbs	\$1181.99
	OCTAFMDRESYSB	Mercruiser from 1983-93, European Volvo Diesel from 1994	17 lbs	1181.99

## Straight Shaft Drive Units

Item	Model	Description	Ship	Net
260406	OCTAFMDMSW	Type 'S' Straight shaft behind-the-dashboard drive unit	12 lbs	\$850.99
260407	OCTAFMDTPW	Type 'T' tilt shaft behind-the-dashboard drive unit	12 lbs	945.99



### ADD THE APPROPRIATE RUDDER FEEDBACK UNIT

## ACS - For All Rotary Mechanical Drive Units

### RUDDER FEEDBACK POTENTIOMETER MODULES

Choose one of the Rudder Feed Back Potentiometer module models below

Item	Model	Description	Ship	Net
260404	OC15SUK27A	Comnav and Si-Tex kit	1 lbs	\$226.99
	OC15SUK27B	Raymarine kit	1 lbs	226.99
	OC15SUK27D	Coursemaster	1 lbs	226.99
	OC15SUK27E	Garmin, Furuno, TMQ and Simrad kit	1 lbs	226.99
260405	OC15SUK83	Simrad Resistance-to-Frequency conversion kit*	1 lbs	189.99

\* Required for Simrad Autopilots

### ACCESSORIES

Item	Model	Description	Ship	Net
257850	OC15109-6	Steering cable assembly - 6 ft	5 lbs	\$131.99
257848	OC15SUK12B	Type B - I/O connection kit	2 lbs	169.99
257849	OC15SUK12C	Type C - I/O connection kit	3 lbs	164.99

## Octopus Gear Pumps

From the design team that brought you the legendary Octopus hydraulic drives, the gear pump offers industry leading reliability and performance in a smaller, lighter, quieter package. Lower power consumption, can be used with smaller autopilot course computers, has a smaller footprint, lower noise and vibration (ideal for sailboat installations) and is suitable for balanced and unbalanced cylinders. Available in 12 & 24 Volt DC.

Item	Model	Description	Ship	Net
260818	OCTAFG0612	600CC/min - 12 Volt DC (6-9ci cylinder)	3 lbs	\$432.99
260819	OCTAFG0624	600CC/min - 24 Volt DC (6-9ci cylinder)	7 lbs	449.99
260820	OCTAFG1012	1000CC/min - 12 Volt DC (10-15ci cylinder)	5 lbs	499.99
260821	OCTAFG1024	1000CC/min - 24 Volt DC (10-15ci cylinder)	9 lbs	578.99

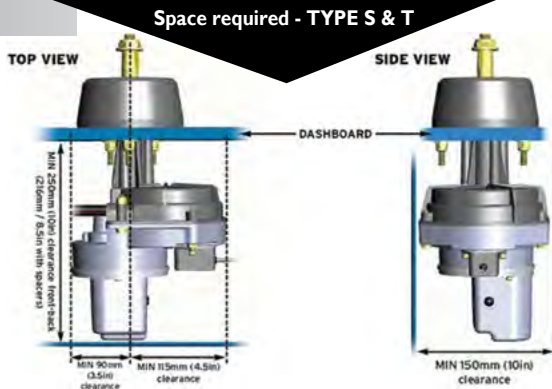



**Evolution InBoard/  
Outboard Autopilots**  
Race, cruise or fish - Evolution will take command



Follow-On Tiller

**Autopilots consist of three main components:  
A drive mechanism, a course computer/processor,  
and a choice of control head shown below.**

Add one of the remote controllers to remotely provide basic, onboard wireless control of any Raymarine SeaTalk autopilot. They are a great value and simple to set up.

The E15023 SmartPilot acts as an instrument repeater and lets you see your data while away from the display. The compact Raymarine S100 remote control gives you basic, onboard wireless control of any Raymarine SeaTalk autopilot, even if you're below deck and out of sight of your autopilot.

**FOLLOW-ON TILLER**

Brings fully functional power steering to remote and secondary control stations anywhere onboard. The Follow-On Tiller controller is designed for use on Raymarine Evolution autopilot systems installed on powerboats only. It is not compatible with Evolution wheel drive, tiller drive, or linear drive systems configured for sailing vessels.

Item **261513** Model **A80532** Ship 2 lbs Net **\$537.99**

**WIRELESS REMOTES**

Connect and control wirelessly with the smartpilot remote and the S100. Set a new course or monitor instrument and navigation data.

Item	Model	SmartPilot wireless remote	Ship	Net
255631	E15023	SmartPilot wireless remote	2 lbs	\$514.99
255632	E15024	S100 wireless remote	2 lbs	378.99

**CONVERTER KIT**

Seataalk converter kit needed to connect to Evolution autopilot

254238	E22158	ST <sup>10</sup> g converter kit*	1 lbs	\$87.99
--------	--------	-----------------------------------	-------	---------



SmartPilot



S100

p70s



p70Rs

**SMARTPILOT CONTROL HEADS**

Item	Model	Control Head	Ship	Net
261168	E70328	p70s control head	2 lbs	\$478.99
261169	E70329	p70Rs control head	2 lbs	537.99

Ready to Install systems-in-a-box are listed below: see the grid at bottom of the page.

**Linear Drives**



**Hydraulic Drives**



Item	Model	Drive Type	Max Vessel Displacement	Max Stroke	Max Rudder Torque	Peak Thrust	Power Consumption	ACU	Ship	Net
253654	M81130	Type 1 linear	24,000 lbs (11,000 kg)	12" (300 mm)	6500 lbs/in	650 lbs	18-36 W	ACU-200	18 lbs	\$1643.99
253537	M81131	Type 2 linear	33,000 lbs (15,000 kg)	12" (300 mm)	10,500 lbs/in	1050 lbs	48-72 W	ACU-400	19 lbs	1917.99
253538	M81132	Type 2 long linear	44,000 lbs (20,000 kg)	16" (400 mm)	14,700 lbs/in	1050 lbs	48-72 W	ACU-400	20 lbs	1899.99
254608	E12207	Type 2 hydraulic linear	48,500 lbs (22,000 kg)	10" (254 mm)	11,300 lbs/in	1488 lbs	N/A	ACU-400	29 lbs	2682.99
253539	M81202	Type 3 hydraulic linear	77,000 lbs (35,000 kg)	12" (300 mm)	23,100 lbs/in	2200 lbs	N/A	ACU-400	34 lbs	2693.99

Item	Model	Drive Type	Ram Capacity	Max Stall Pressure at 12 VDC	Peak Flow Rate	ACU	Ship	Net
253547	M81120	Type 1 hydraulic	4.9 in <sup>3</sup> - 14 in <sup>3</sup>	750 PSI (50 bar)	67 in <sup>3</sup> /min	ACU-200	6 lbs	\$712.99
253546	M81121	Type 2 hydraulic	14 in <sup>3</sup> - 21 in <sup>3</sup>	1450 PSI (100 bar)	122 in <sup>3</sup> /min	ACU-400	7 lbs	886.99
253545	M81122	Type 3 hydraulic	21 in <sup>3</sup> - 30.5 in <sup>3</sup>	1160 PSI (80 bar)	175 in <sup>3</sup> /min	ACU-400	8 lbs	1096.99

**Evolution Systems Pilots**

**EVOLUTION SYSTEM PACKS WITH DRIVES**

Item	Model	Pilot Pack Description	Typical Vessel Type	Contents	Ship	M.A.P
261323	T70157-I	EV-200, hydraulic	Hydraulic mid-sized power	Evolution autopilot with p70Rs control head, ACU-200, EVI sensor core, EVI cabling kit and type 1 hydraulic pump	19 lbs	\$2899.99
261325	T70158-I	EV-200, linear	Mechanically steered mid-sized sail	Evolution autopilot with p70s control head, ACU-200, EVI sensor core, EVI cabling kit and type 1 mechanical linear drive	46 lbs	3299.99

**EVOLUTION SYSTEM PACKS - NO DRIVES**

Item	Model	Pilot Pack Description	Typical Vessel Type	Contents	Ship	M.A.P
261407	T70155-P70S	EV-200 sail	Mid-size sail/type 1 drives	Evolution autopilot with p70s control head and ACU-200, EVI sensor core, EVI cabling kit (suitable for type 1 drives)	13 lbs	\$1999.99
261324	T70156-I	EV-200 power	Mid-size power/type 1 drives	Evolution autopilot with p70Rs control head and ACU-200, EVI sensor core, EVI cabling kit (suitable for type 1 drives)	14 lbs	1999.99
261409	T70160	EV-300 solenoid	Vessels with solenoid controlled steering	Evolution solenoid autopilot with p70Rs control head and ACU-300, EVI sensor core, EVI cabling kit (suitable for solenoid drives)	14 lbs	2899.99
261406	T70161-P70S	EV-400 sail	Large sail/type 2 and 3 drives	Evolution autopilot with p70s control head and ACU-400, EVI sensor core, EVI cabling kit (suitable for type 2 and 3 drives)	14 lbs	2999.99
259642	T70162	EV-400 power	Large power/type 2 and 3 drives	Evolution autopilot with p70Rs control head & ACU-400, EVI sensor core, EVI cabling kit (suitable for type 2 and 3 drives)	14 lbs	2999.99



Evolution Autopilots



Evolution EV-100 Wheel Pilot

The EV-100 wheel pilot comprises a fully enclosed wheel-drive for simple installation and superb autopilot performance.

- Quick and easy installation
- Fits most types of wheel
- Simple, robust clutch engagement mechanism
- Revs per minute (rpm): 9
- Thrust: 30 Nm
- Connections: STng (x1), NMEA 2000 with adapter cable
- Ideal for smaller, wheel-steered yachts

\*Always take the fully laden displacement weight of your vessel into account; this is often 20% above the designed displacement.

Item	Model	Pilot Pack Description	MAX Cubic in Displacement	Vessel Type	EV Sensor	ACU	Supplied Control Head	Drive Unit Supplied	Ship	Net
261304	T70152-P70S	EV-100 Wheel pilot	16,500 lbs (7485 kg)	Sail	EV-I	100	p70s	Wheel drive	15 lbs	\$1334.99



Evolution EV-100 Power Autopilot

The EV-100 Power autopilot system consists of the revolutionary EV-sensor core, the fully-sealed and compact ACU-100, a p70Rs control interface, and Raymarine's new highly efficient 0.5 litre hydraulic pump. The EV-100 is perfect for vessels with single outboard engines and hydraulic steering, install the entire system above or below decks as required, and benefit from world-leading autopilot performance at a truly head-turning price.

- Designed for smaller powerboats
- The drive unit is matched to the ram capacity of the steering system

Item	Model	Pilot Pack Description	MAX Cubic in Displacement	Vessel Type	EV Sensor	ACU	Supplied Control Head	Drive Unit Supplied	Ship	Net
261410	T70154	EV-100 Power	Cubic inch displacement of .5 liter pump 3.1-6.7	Power	EV-I	100	p70s	0.5L Hydraulic Pump	15 lbs	\$1341.99



Evolution EV-100 Tiller Autopilot

- The tiller drive unit is compact and unobtrusive and used by some of the world's top single-handed sailors
- The EV-100 tiller is ideal for smaller, tiller-steered yachts

Item	Model	Pilot Pack Description	MAX Cubic in Displacement	Vessel Type	EV Sensor	ACU	Supplied Control Head	Drive Unit Supplied	Ship	Net
261326	T70153	EV-100 Tiller pilot	13,200 lbs (6000 kg)	Sail	EV-I	100	p70s	Tiller drive	13 lbs	\$1419.99



EV1 Sensor Core

The EV-I is designed for Evolution mechanical and hydraulic autopilot systems. SeaTalk<sup>ng</sup> networking enables a single cable connection for power and data to the Evolution ACU (actuator control unit) and extended SeaTalk<sup>ng</sup> and NMEA 2000 networks. Can also be used as a heading sensor.

Item 259645 E70096 Ship 2 lbs Net \$589.99



EV-150 Hydraulic Autopilot System for PowerBoats

The Evolution ACU150 Hydraulic autopilot system pack is a complete autopilot-in-a-box kit at a GREAT PRICE that is ready to install on many popular fishing and cruising powerboats with hydraulic steering. EV-150 system is engineered specifically to meet the needs of small to medium sized hydraulically steered vessels with a steering ram capacity between 4.9 cu. in. (80 cc) and 14.0 cu in (230 cc).

The EV-150 system is for 12 Volt DC electrical systems only. The system comes complete with our p70Rs autopilot controller, EV1 Sensor Core, ACU150 Actuator Control Unit, Type I Hydraulic Pump, and an Evolution autopilot cabling kit.

Item 261235 T70330 Ship 15 lbs Net \$1999.99



Tiller Autopilots

Raymarine ST1000 & ST2000 Removable Cockpit Autopilots for Tiller Steered Yachts

Invented by Autohelm in 1973, tiller pilots have consistently been the world's most popular pilot ever since, setting the standard for performance, reliability and ease of use. AutoTack lets you handle the sheets while the pilot tacks the boat and AutoSeastate intelligently keeps the boat on course while conserving power.

Whether used as a stand-alone pilot or with SeaTalk/ NMEA GPS, the clear, backlit LCD and 6 button keypad make these pilots safe and easy to use.

Recommended Maximum Displacement

- Raymarine ST1000: 3,000 kg (6,600 lbs)
- Raymarine ST2000: 4,500 kg (10,000 lbs)

Remember to always take the fully laden displacement weight of your vessel into account (often 20% above the designed displacement).

Item	Model	Description	Ship	Net
250145	A12004	ST1000+ Advanced tiller pilot for sailing vessels up to 6,600 lbs (3,000 kg)	5 lbs	\$400.99
250146	A12005	ST2000+ Advanced tiller pilot for sailing vessels up to 10,000 lbs (4,500 kg)	6 lbs	491.99









**Over 60 Years of  
Autopilot Design  
and Development**

Renowned for their reliability, Simrad pilots have won more awards than their competition combined. Choose from a selection of displays, controllers, computers and drives below to safely steer your boat. Every Simrad steering innovation builds upon a legacy encompassing over sixty years of autopilot development which continues today at Simrad Yachting's autopilot research hub in Norway.

Use this table for guidance in choosing the autopilot for your needs but always confirm with Simrad or your installer.



Steering System	Size/Capacity/Compatibility	Recommended AP Drive	Required Computer
Outboard/Stern Drive with Hydraulic Steering	Hydraulic cylinder < 15 cubic in or 250 cc	RPU80	NAC-2
	Hydraulic cylinder(s) 10-33 cubic in or 160-550 cc	RPU160	NAC-3
	Hydraulic cylinder(s) 17-58 cubic in or 290-960 cc	RPU300	NAC-3
Outboard/Stern Drive with Mechanical Steering	Compatible with Morse 290,304411 and Teleflex SSC52 cables	Helm-1	NAC-2
Inboard with Hydraulic Steering	Hydraulic cylinder < 15 cubic in or 250 cc	RPU80	NAC-2
	Hydraulic cylinder(s) 10-33 cubic in or 160-550 cc	RPU160	NAC-3
	Hydraulic cylinder(s) 17-58 cubic in or 290-960 cc	RPU300	NAC-3
Inboard with Mechanical Steering	Boats up to 9000 kg	T0	NAC-2/AC42
	Boats up to 12000 kg	T1*	NAC-3
	Boats up to 20000 kg	T2*	NAC3/AC42/H5000
	Boats up to 36000 kg	T3*	NAC-3
	Boats up to 55000 kg	T4 (24 VDC Only) †	NAC-3
Sailing Boat with Quadrant or Tiller	25 ft to 37 ft	SD10	NAC-2
	Up to 45 ft	DD15	NAC-3
	Boats up to 9000 kg	T0	NAC-2
	Boats up to 12000 kg	T1*	NAC-3
	Boats up to 20000 kg	T2*	NAC-3
	Boats up to 36000 kg	T3	NAC-3
	Boats up to 55000 kg	T4†	NAC-3

\* 12 VDC or 24 VDC (24 VDC is Special Order only) †Special Order only - Call for details

## Tiller Autopilots



### Simrad TP10, TP22, TP32 Tiller Pilots

Designed to use minimum power while providing maximum thrust. The storm-proof body contains all controls and has been tested for hours in total immersion. Exceptionally quiet, this series gives fast and positive performance to meet the needs of the serious cruising yachtsman. The Tillerpilot TP10 is a no-nonsense design at a very attractive price. The TP10 is not suitable for ferro-cement yachts, steel yachts or hydraulically steered vessels; however, other

sailing vessels up to 32' can be accommodated. The Tillerpilots TP22 is built for vessels up to 32' and TP32 for vessels up to 37' are the ultimate state-of-the-art cockpit pilots. As well as having the ability to interface with Simrad's instrument system, they can also accept NMEA wind data and navigation (steer to waypoint/route) data via SimNet and NMEA 2000®. The built-in NMEA processor allows NMEA 0183 compatible equipment to be connected directly to the TP22 and TP32 without any need for a separate interface unit. 10-16 VDC.

TP22 and TP32 features:

- Steer to compass
- Easy installation
- Intelligent steering action
- SimNet capability
- Auto tack
- Storm proof
- Night illumination

Item	Model	Description	Max Displacement	Ship	Net
259215	TP10	For sailing vessels up to 32' (3.7 tons)	7,400 lbs	5 lbs	\$394.99
259216	TP22	For sailing vessels up to 34' (5 tons)	10,200 lbs	6 lbs	494.99
259217	TP32	For sailing vessels up to 37' (6.3 tons)	12,600 lbs	7 lbs	679.99



# WindSense<sup>®</sup>

## Perfect for Day Sailors!

WindSense is a new wireless wind system designed to allow iPads, tablets, SmartPhones and PCs to display accurate apparent wind speed and direction. It features a high quality, precision mast head sensor with 20 m cable that connects to a below-decks interface unit providing a WiFi and NMEA 0183 wired connection. Existing NMEA compatible sensors can also be connected to the NMEA input to allow the wireless network to share other available on board instrument data. It's compatible with a wide range of apps for iOS and android. The built-in WiFi will typically footprint a GRP boat up to 30 m (98 ft)

It has been attractively priced and positioned as a low cost replacement or addition to any marine electronics system, but offers significantly enhanced accuracy, reliability and functionality with easy interfacing enabling a tablet to become a complete instrument display with other connected sensors. There are many vessels equipped with just a speed and depth system that require wind data, too and, also, many older wind systems requiring replacement where customers do not want the substantial cost of a totally new instrument package. Depending upon the app utilized, true wind information, VMG and other sailing performance parameters may also be calculated.

**Key features:**

- Stand alone or networkable (via NMEA 0183) wind system with precision mast head unit
  - Wired connection with super-thin cable from MHU-to-below-deck interface with wireless WiFi and wired NMEA connections
  - Ultra tough Igildur™ mast head unit bearings for exceptional life and corrosion resistance
  - Full range of apps for iOS and Android plus compatible with multiple PC and MAC apps
- Installation is easy with an ultra-thin mast head unit cable with removable connector which plugs directly into the interface unit. It's then just a matter of connecting power and any other NMEA interface connections you require. WindSense is compatible with a wide variety of new and existing apps and charting programs with instrument displays. Both TCP/IP and UDP connections are supported. There are also free apps from Digital Yacht plus use popular, low cost apps from many 3rd party developers too. Apps can also calculate true wind information, VMG and other performance sailing data like polars and laylines for racing.

Item	Model	Ship	Net
261239	ZDIGWS	4 lbs	\$494.99

### Product Installation

### WindSense<sup>®</sup>

- Ultra thin mast head unit cable is easy to install and offers superior reliability over other proprietary wireless solutions
- WindSense interface unit can be installed with a footprint suitable for a boat up to 30m LOA
- WiFi interface supports UDP and TCP/IP connection protocols and support for up to 7 connected devices
- WiFi interface can be programmed to join another wifi network if required

## SCANSTRUT ROKK Mini

designed for life at sea

ROKK Mini is a compact and multi-adjustable mounting system for smart phones, tablets, small fishfinders, digital and action cameras. Small in size but big on features, ROKK Mini is simply the toughest, most reliable mount for your tech onboard. No compromise.

1. Buy a mini adjustable body
2. Choose your top plate based on what you want to mount
3. Choose your base plate based on where you want to mount it.
4. It's that easy!

TOP PLATES

BASE PLATES

**NEW! LOWRANCE HOOK2 BUNDLES FOR 4X, 4X GPS, 5X AND 5 MODELS**

Hook2 bundles include quick release adjustable body, Hook2 clamp and choice of mounting.

Item	Description	Ship	M.A.P.
261801PKG	Screw down mount	1 lbs	\$69.99
260960PKG	Rail clamp	2 lbs	84.99
261153PKG	Kayak track base	2 lbs	84.99
<b>BUNDLE FOR TABLETS</b>			
261825PKG	Surface mount	2 lbs	\$117.99
260888PKG	Rail mount	2 lbs	94.99
261826PKG	Suction mount	2 lbs	129.99
<b>BUNDLE FOR CELL PHONES</b>			
261827PKG	Surface mount	2 lbs	\$90.99
261166PKG	Rail mount	2 lbs	94.99
261167PKG	Suction mount	2 lbs	94.99
<b>COMPONENTS</b>			
260784	ROKK Mini adjustable body	1 lbs	\$34.99



Item	Model	Description	Ship	Net
260789	RL-508	Universal tablet clamp	1 lbs	\$19.99
260790	RL-509	Universal phone clamp	1 lbs	14.99
260791	RL-510	GoPro plate	1 lbs	11.99
260792	RL-511	1/4" Camera plate	1 lbs	11.99
260793	RL-512	Raymarine Dragonfly 4, 5, and 7 Pro	1 lbs	11.99
<b>BASE PLATES</b>				
260785	RLS-401	Mini surface mount	1 lbs	\$11.99
260786	RLS-402	Mini rail mount	1 lbs	19.99
260787	RLS-403	Mini cable tie mount	1 lbs	14.99
260788	RLS-404	Mini self adhesive surface mount	1 lbs	14.99
261156	RLS-405	ROKK Mini suction mount	1 lbs	22.99
<b>ACCESSORIES</b>				
260794	RL-TETH	Safety tether	1 lbs	\$11.99

**NEW!**

**ROKK WATERPROOF WIRELESS 12/24V CHARGERS**

Say goodbye to smartphone charging cords when you join the wireless world of Qi (pronounced chee from the Chinese word qi) inductive charging with the Rokk waterproof wireless charger. For compatibility with your phone visit: www.defender.com

- Sealed unit with an IPX6 waterproof rating
- Compatible with 12 & 24 Volt DC power systems

Item	Model/Description	Ship	Starting at
261694	Choose mount method (Bezel, hidden or surface)	4 lbs	\$64.99
<b>Receiver Patch kits for Non-Qi enabled phones:</b>			
261816	SC-CW-RCV-LU Receiver patch - Lightning	1 lbs	12.75
261817	SC-CW-RCV-MU Receiver patch - Micro USB	1 lbs	12.75



**ROKK CHARGE+ WATERPROOF USB SOCKET**

- Universal fit for any USB Type-A connector
- Charge up to 2 devices at a time
- Click & Lock lid
- Output current 4.2 A (total)
- IPX6 waterproof with cover closed
- Up to 3x faster than standard USB sockets
- Anti-corrosion coating on circuit board
- 316 stainless hinge and spring
- Dimensions: 3.7" L x 1.53" W
- Voltage: 12 - 24 Volt DC

Item	Model	Ship	lbs	M.A.P.
202460	SC-USB-02			\$36.50





Better Maps

Compatible with Raymarine, Garmin, Standard Horizon

C-MAP 4D MSD

261851	NA-D062	Nova Scotia to Chesapeake Bay	\$312.99
	NA-D063	Chesapeake Bay to Cuba	312.99
	NA-D064	Gulf of Mexico	312.99
	NA-D065	The Caribbean & Central America	312.99



C-MAP 4D Continental MSD Chart (Vector Only)

261852	NA-D033	Atlantic Coast, Gom & Caribbean Continental	164.99
	NA-D035	Pacific Coast: Panama to Alaska Continental	164.99

Compatible with B&G, Simrad & Lowrance

C-MAP N+ MSD Chart

261853	NA-Y062	Nova Scotia to Chesapeake Bay	\$312.99
	NA-Y063	Chesapeake Bay to Cuba	312.99
	NA-Y064	Gulf of Mexico	312.99
	NA-Y065	The Caribbean & Central America	312.99



C-MAP N+ Continental MSD Chart (Vector Only)

261854	NA-Y033	Atlantic Coast, Gom & Caribbean Continental	164.99
	NA-Y035	Pacific Coast: Panama to Alaska Continental	164.99

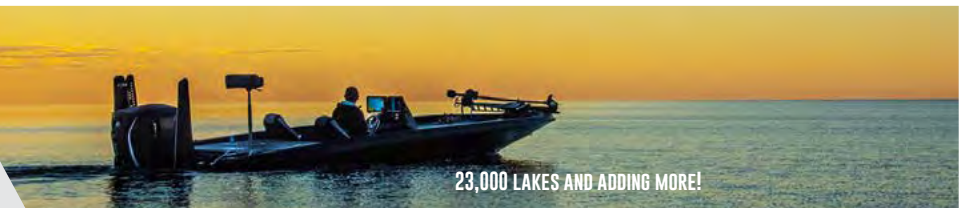
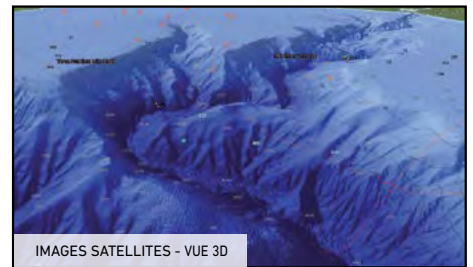
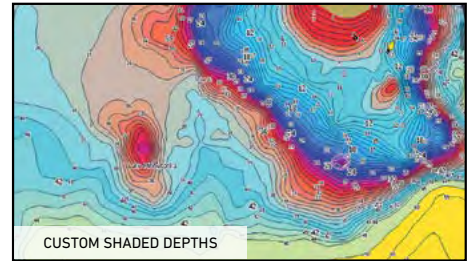
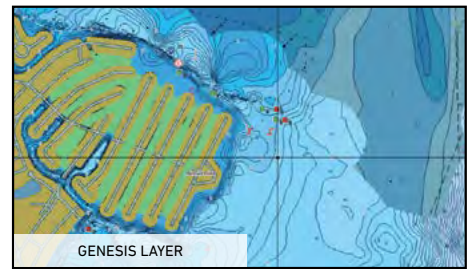

Every Navionics product includes a one-year subscription to daily updates and advanced features:



Create new maps in real time with SonarChart™ Live.



Head to your destination with a detailed route created just for you by Dock-to-dock Autorouting.



Select a fishing range or highlight shallow water with Advanced Map Options.



Transfer routes and markers and update charts wirelessly with Plotter Sync.

A compatible plotter is required for advanced features.

**DAILY UPDATES** ensure you have all our latest chart edits. Catch more fish using the most detailed and accurate marine and lake charts you'll find, with clearly marked shorelines, underwater structure, artificial reefs, wrecks, rocks, and more.

**SONARCHART™ 1 FT HD CONTOURS** make it easy for you to study both sharp and subtle changes in depth and find the most likely places where fish may congregate. Enhance the detail in your area with depth data from your sonar. For Navionics+ US & Canada, SonarChart™ must be downloaded.

NAVIONICS+ LAKE/MARINE CHARTS

Item	MSD/NAV#	Description	Net
259765	MSD/NAV+NI	US & Canada	\$189.99
260708	MSD/NAV+3XG	Caribbean & S. America	189.99
259871	MSD/NAV+W	Global Regions	234.99
261054	MSD/NAV+CA	Canada & Alaska	139.99

HOTMAP PLATINUM LAKE

Item	MSD/NAV#	Description	Net
261054	MSD/NAV+NO	North	\$147.99
	MSD/NAV+SO	South	147.99
	MSD/NAV+EA	East	147.99
	MSD/NAV+WE	West	147.99

PLATINUM+ MARINE CHARTS XL

CF format cards available while supplies last, call to order

Item	MSD/NAV#	Description	Net
257882	MSD/673P+	Maine	\$189.99
	MSD/674P+	Boston-New York	189.99
	MSD/637P+	New Jersey-Delaware	189.99
	MSD/634P+	Chesapeake Bay	189.99
	MSD/645P+	North Carolina	189.99
	MSD/642P+	S Carolina-N Florida	189.99
	MSD/699P+	N Bahamas	189.99
	MSD/632P+	Central & S Florida	189.99
	MSD/630P+	East Gulf of Mexico	189.99
	MSD/651P+	Central Gulf of Mexico	189.99
	MSD/635P+	West Gulf of Mexico	189.99
	MSD/644P+	California South-Baja & Hawaii	189.99
	MSD/643P+	California & Oregon	189.99
	MSD/638P+	Puget Sound	189.99
257881	MSD/647P+	Lake Superior	234.99
	MSD/646P+	Lake Michigan	189.99
	MSD/652P+	Lake Huron	234.99
	MSD/649P+	Lake Erie & Saint Clair	234.99
	MSD/648P+	Lake Ontario-Champlain	234.99

## AXIOM™

### AXIOM XL

**NEW!**



### AXIOM



### AXIOM Pro



Support for the **best charts** from Navionics and LightHouse Raster and Vector Charts sourced from leading map makers like NV Digital, Blue Latitude and more. C-MAP chart compatibility available in Lighthouse 3 software update.

**Lighthouse 3 OS** is fast, fluid and easy to learn. An uncluttered interface is easily personalized for your style of navigating.  
 • Built-in RealVision 3D™ sonar • LightHouse 3 operating system • Blazing fast quad core performance

#### AXIOM XL GLASS BRIDGE MULTIFUNCTION DISPLAY

At the heart of each Axiom XL display is a blazing fast quad core processor that delivers a responsive and powerful all-in-one big screen navigation experience. Axiom XL brings together multiple technologies and sensors into single or multi display helm solution. Integrate Axiom XL with additional Axiom XL displays or connect seamlessly with Raymarine's family of Axiom and Axiom Pro displays at remote stations.

A powerful network and video integration platform, Axiom XL displays feature three Ethernet ports for connecting radar, CHIRP and 3D sonar modules, plus additional Axiom family displays. FLIR thermal camera support enhances awareness and HDMI input enables Axiom XL to serve as a remote PC or entertainment display. Enjoy multi-touch screen control or add the Raymarine RMK-10 keypad for complete remote system control.

**Starting at \$6799.99**

#### AXIOM AND AXIOM PRO

The other powerful multifunction navigation systems from Raymarine. With built-in RealVision 3D™ sonar, the all new LightHouse 3 operating system, and blazing fast quad core performance, Axiom will transform your time on the water.

**Starting at \$849.99**

	AXIOM	AXIOM DV	AXIOM RV	AXIOM PRO S	AXIOM PRO RVXI	AXIOM XL
Controls*	Touch Only	Touch Only	Touch Only	Hybrid Touch with Buttons	Hybrid Touch with Buttons	Multi-Touch
IPS Display	No	No	No	Yes	Yes	Yes
Sounder	None	High Chirp/DownVision/600W Dual Frequency	High CHIRP/DownVision/SideVision/RealVision 3D/600W Dual Frequency	Compatible with Raymarine CPT-S Transducers Only	1kW High, Medium, Low CHIRP/DownVision/SideVision/RealVision 3D/1kW Dual Frequency	Optional RVXI000 remotely mounted 3D CHIRP sonar module.
Micro SD Slot	1 Rear	1 Rear	1 Rear	2 Front	2 Front	Uses Card Reader
Ethernet	Yes	Yes	Yes	Yes	Yes	Yes
Seataalk ng/NMEA2000	Yes	Yes	Yes	Yes	Yes	Yes
NMEA 0183 connection	No	No	No	2 in & 1 out	2 in & 1 out	Card Reader
Radar compatible	Yes	Yes	Yes	Yes	Yes	Yes
Thermal vision	IP Camera Input Only	M132 or M232 Capable	M132 or M232 Capable	M132 or M232 Capable + Analog	M132 or M232 Capable + Analog	M132 or M232 Capable + Analog
External Sonar						
GPS 10Hz 72 Channel	Built-in	Built-in	Built-in	Built-in	Built-in	Built-in
WiFi-Remote App Capable	Built-in	Built-in	Built-in	Built-in	Built-in	Built-in
Stdbby/Auto button for AP	No	No	No	Yes	Yes	Yes

\* All units compatible with the RMK-10 for complete remote system control

#### RMK-10 REMOTE KEYPAD

The fully backlit RMK-10 includes dedicated keys for home, menu, zoom in/out, window control, waypoint management, power/brightness, as well as Evolution autopilot control. The RMK-10 can be surface-mounted or flush-mounted, and is available with key mats for horizontal or vertical installation. This gives you the flexibility to install the RMK-10 just about anywhere.



Item	Model/Description	Ship	Net
261310	RMK-10 portrait	3 lbs	\$313.99
261311	RMK-10 portrait or landscape	3 lbs	331.99

#### Oceanic Systems Logo Poseidon® Data Visualization Stations

- Sleek, and bright, these stations provide user adjustable screen design
- Designed with ease of installation in mind. With minimum cabling to speed installation and reduce weight and complexity
- Configurable, clean and modern graphics with choice of background images, CCTV camera windows and customized floor plans, making it quick and easy to customize
- Comes with incorporated image library which users can configure, resize and modify position

#### 5180 POSEIDON® SYSTEM UNIT

- The centerpiece of the Poseidon® system, providing alarms, control and monitoring to all of your vessels PLC, NMEA200 and Oceanic UDP devices
- Boasts a powerful Quad Core processor, is passively cooled and is supported by a high-quality SSD. The system has no moving parts, so it is suitable for harsh marine environments
- Dual CAN, dual Ethernet and dual HDMI, there is no shortage of connectivity
- Soon to be available in 10.1", 15.6" 19" & 21.5" sizes, it will be a valuable addition to any Networked marine bridge system



**NEW!**



**- Available Spring of 2019 -**



## Quantum 2 CHIRP Radar with Doppler Collision Avoidance



The next generation of CHIRP pulse compression radar, Raymarine's Quantum 2 CHIRP radar with Doppler collision avoidance technology, provides superior target awareness at both long and extremely short ranges.

Using advanced Doppler processing, the system instantly highlights moving radar contacts and color codes them to indicate whether they are inbound or outbound, making it easy to discern potentially dangerous targets when navigating in high-traffic areas.

### Features:

- Fully automatic target acquisition and tracking
- Customizable safety or alarm zones
- Calculates the course, speed, closest point of approach
- The new True Trails enables you to see a historical "wake" behind every moving contact 24-mile range for early detection of traffic, navigation aids, landfall and weather
- Easy upgrade – Quantum 2 fits the same bolt pattern as other Raymarine scanners
- Safe emissions – mount Quantum anywhere onboard
- Lightweight and easy to install, this radar has very low power consumption, friendly to those vessels running exclusively on battery power
- Available in traditionally wired or WiFi models

Item	Model/Description	Ship	Net
D 261559	E70498 Quantum Q24D WiFi only - No cables	36 lbs	\$1899.99
D	T70416 Quantum Q24D WiFi, 10 m power & data cable	36 lbs	1949.99
D	T70417 Quantum Q24D WiFi, 15 m power & data cable	36 lbs	1999.99

## CHIRP Radar

### QUANTUM™ 24C CHIRP PULSE COMPRESSION RADAR

Quantum wireless radar, by FLIR, is the new generation of marine radar featuring CHIRP pulse compression technology.

Setting a new standard for compact solid state radar, the Quantum wireless Chirp radar delivers superior radar imaging on both long and extremely short ranges. Integrated WiFi and thin cabling simplifies installation plus Quantum's energy efficient and lightweight design provides safe radiated emissions and substantially reduced power consumption.

Item	Model/Description	Ship	Net
D 261435	E70344 Quantum Q24C WiFi only - No cables	36 lbs	\$1499.99
D	E70210 Quantum Q24C WiFi, 10 m power cable	36 lbs	1649.99
D	T70243 Quantum Q24C WiFi, 10 m power & data cable	36 lbs	1699.99

## GPS Sensors

### Raystar RS150 GPS sensor with Pole Mount adaptor

- Compact and accurate Satellite Differential GPS
- Self contained waterproof GPS receiver and antenna combined
- Delivers accuracy better than 3 meters
- Includes a 1"-14 TPI antenna mount adaptor,
- 72-channel GPS receiver
- Fast 10 Hz position updates
- Satellite differential GPS-compatible. Space-Based Augmentation System (SBAS) enabled with WASS, EGNOS, MSAS and GAGAN support
- A GNSS receiver with GLONASS compatibility
- Low power consumption: 30 mA (1 LEN)
- SeaTalkng and NMEA2000 compatible (using a device net adapter cable)
- Designed for low profile surface mounting or optional pole mounting

Note: Seataalk systems need the optional E22158 converter kit (Sold separately)

Item	Model	Description	Ship	Net
261475	T70327	Raystar RS150 GPS sensor with Pole Mount adaptor	1 lbs	\$289.99

### Digital Yacht DualNav GPS Sensor - for non Seataalk devices

- Super accurate (50) channel GPS with GLONASS
- Power: 9.6-28.8 Volt DC
- Utilizes industry standard NMEA0183 data format
- Draw: 30 mA @12 Volt DC
- Includes 10 m cable

Item	Model/Description	Ship	Net
259801	ZDIGGPS150	2 lbs	\$169.99



## Magnum Open Arrays

Magnum high performance open array radars bring long range performance, best-in-class target tracking, and unmatched small target radar imaging to Raymarine multifunction navigation displays. Packaged in a sleek and modern open array pedestal that looks great atop any vessel, the Magnum radar is also built to withstand the elements. Available in 4 kW or 12 kW power output options and with either a 4-foot or 6-foot array, Magnum radar is compatible with Raymarine's Axiom and Axiom Pro multifunction navigation displays running LightHouse 3. Magnum is also compatible with all LightHouse 2 multifunction displays, C and E-Series Widescreen and E-Series Classic multifunction displays.

- **Superior Bird Mode** - Use Magnum's fully automatic bird mode to find sea birds at long range. Get to the fish faster and use less fuel
- **Enhanced Radar Imaging** - Raymarine's beam sharpening technology allows smaller antennas to perform like much larger systems, with better than 1 degree bearing resolution for incredible target separation, map-like coastal detail and superior long-range performance
- **Best in Class Target Tracking** - Magnum delivers superior situational awareness with fully automatic ARPA target acquisition and tracking. Combine Magnum with a Raymarine Evolution 9-axis heading sensor for fast and accurate target plots
- **Trusted Performance** - Superior target detection out to 96 nautical miles offers advanced visibility of approaching weather systems and large vessels coming over-the-horizon. Plus, Magnum is built with the same radar technologies chosen for over 2,000 USCG vessels
- Includes VCM100, and 15 m Raynet cable

Item	Model/Description	Ship	Net
261855	T70408 4 kW Magnum with 4' Open array	102 lbs	\$4699.99
	T70410 4 kW Magnum with 6' Open array	102 lbs	5199.99
261856	T70412 12 kW Magnum with 4' Open array	92 lbs	6199.99
	T70414 12 kW Magnum with 6' Open array	103 lbs	6699.99

FOR MORE INFORMATION PLEASE VISIT [WWW.DEFENDER.COM/RAYMARINE.JSP](http://WWW.DEFENDER.COM/RAYMARINE.JSP)



## Oceanic Systems Digital Tank Level Gauges

- Digital displays for fuel, fresh water, gray water, or black water tanks
- Feature a high and low level alarm sounder and flashing RED LED
- Alarm limits are user settable and the sounder can be muted from the front of the panel
- Fitted with a 10 Amp relay that can control an external alarm or device
- BLUE LED display automatically adjusts its brightness to the ambient light levels
- Certified to NMEA2000 standard it attaches via a single "Micro" plug
- Current draw is less than 150 mA from the network and has a IP66 waterproof rating

AVAILABLE SPRING 2019

# Raymarine®



## Raymarine Sonar Modules

	RVX1000 3D CHIRP	CP570 PROFESSIONAL SONAR	CP470 CHIRP SONAR	CP370 DIGITAL CLEARPULSE™
Item	<b>261669</b>	<b>260325</b>	<b>260324</b>	<b>260323</b>
Description	RealVision 3D sonar technology, CHIRP Side and DownVision, plus a high powered 1kW dual channel CHIRP sonar	Engineered for serious anglers, bring best-in-class target separation and high resolution CHIRP sonar imagery	Intelligently filters out unwanted noise while producing high resolution fish targets and reliable bottom tracking	The CP370 delivers exceptional clarity, sharper fish targets and automatic operation
Depth Range	High Frequency CHIRP = 900 ft   DownVision = 600 ft   SideVision = 300 ft Port and Starboard   1kw = 5,000 ft	10,000 ft (3000 m)	10,000 ft (3000 m)	5000 ft (1500 m)
Ship	4 lbs	16 lbs	6 lbs	4 lbs
Net	<b>\$1499.99</b>	<b>\$1788.99</b>	<b>\$1069.99</b>	<b>\$789.99</b>

DUAL FREQUENCY TRANSDUCERS									
Item	Model	Material	Mounting Style	Power	Frequency	Connector	Ship	Net	
<b>259146</b>	<b>A102138</b> P58	Plastic	Transom Mount	600 w	50 / 200	7 pin a-series style	2 lbs	<b>\$91.99</b>	
<b>254871</b>	<b>E66054</b> P66	Plastic	Transom Mount	600 w	50 / 200	8 pin CP370 style	3 lbs	<b>147.99</b>	
<b>259767</b>	<b>A80171</b> P319	Plastic	Through Hull	600 w	50 / 200	7 pin a-series style	3 lbs	<b>163.99</b>	
<b>250480</b>	<b>E66087</b> B60 20°	Bronze	Through Hull	600 w	50 / 200	7 pin a-series style	5 lbs	<b>274.99</b>	
<b>250481</b>	<b>E66088</b> B60 12°	Bronze	Through Hull	600 w	50 / 200	7 pin a-series style	5 lbs	<b>274.99</b>	
<b>250478</b>	<b>E66085</b> B60 20°	Bronze	Through Hull	600 w	50 / 200	8 pin CP370 style	6 lbs	<b>274.99</b>	
<b>250479</b>	<b>E66086</b> B60 12°	Bronze	Through Hull	600 w	50 / 200	8 pin CP370 style	5 lbs	<b>274.99</b>	
<b>250001</b>	<b>A66090</b> B744V	Bronze	Through Hull w/ Fairing	600 w	50 / 200	7 pin a-series style	8 lbs	<b>405.99</b>	
<b>255341</b>	<b>A66091</b> B744V	Bronze	Through Hull w/ Fairing	600 w	50 / 200	8 pin CP370 style	8 lbs	<b>391.99</b>	
<b>259270</b>	<b>P79-RAYA</b> P79	Plastic	In-Hull	600 w	50 / 200	7 pin a-series style	3 lbs	<b>128.00</b>	
<b>251831</b>	<b>E66008</b> P79	Plastic	In-Hull	600 w	50 / 200	8 pin CP370 style	3 lbs	<b>154.99</b>	

CHIRP/DOWNVISION									
Item	Model	Material	Mounting Style	Power	Frequency	Connector	Ship	Net	
<b>261333</b>	<b>A80351</b> CPT100-DVS	Plastic	Transom Mount	600 w	50 / 200	9 pin	3 lbs	<b>\$109.99</b>	
<b>259725</b>	<b>A80277</b> CPT-110	Plastic	Through-Hull	600 w	50 / 200	9 pin	4 lbs	<b>244.99</b>	
<b>260581</b>	<b>A80350</b> CPT-120	Bronze	Through Hull w/ Fairing	600 w	50 / 200	9 pin	6 lbs	<b>309.99</b>	
<b>261050</b>	<b>E70342</b> CPT-S	Plastic	Transom Mount	600 w	50 / 200	9 pin	2 lbs	<b>54.99</b>	
<b>261478</b>	<b>E70339</b> CPT-S 0°	Plastic	Through-Hull	600 w	50 / 200	9 pin	3 lbs	<b>134.99</b>	
<b>261047</b>	<b>E70341</b> CPT-S 20°	Bronze	Through-Hull	600 w	50 / 200	9 pin	4 lbs	<b>219.99</b>	
<b>261048</b>	<b>E70340</b> CPT-S 12°	Bronze	Through-Hull	600 w	50 / 200	9 pin	5 lbs	<b>219.99</b>	

CHIRP TRANSDUCERS (CP470/570/AXIOM PRO)									
Item	Model	Material	Mounting Style	Power	Frequency	Connector	Ship	Net	
<b>259580</b>	<b>T70063</b> B75 (Pair)	Bronze	Through Hull	600 w	50 / 200	11 pin	8 lbs	<b>\$1299.99</b>	
<b>259578</b>	<b>A80012</b> M265LH	Plastic	In-Hull	1000 w	50 / 200	11 pin	13 lbs	<b>1299.99</b>	
<b>259673</b>	<b>A80038</b> M265LM	Plastic	In-Hull	1000 w	50 / 200	11 pin	14 lbs	<b>1431.99</b>	
<b>259581</b>	<b>T70072</b> B1751 8-15° (Pair)	Bronze	Through Hull	1000 w	50 / 200	11 Pin	24 lbs	<b>2449.99</b>	
<b>259582</b>	<b>T70075</b> B1751 16-24° (Pair)	Bronze	Through Hull	1000 w	50 / 200	11 Pin	24 lbs	<b>2449.99</b>	
<b>261390</b>	<b>T70318</b> RV-212 5-15° (Pair)	Bronze	Through Hull	3D 300W/Downvision 600W Conical 900W	50 / 200	25 Pin	11 lbs	<b>1582.99</b>	
<b>261391</b>	<b>T70319</b> RV-220 15-25° (Pair)	Bronze	Through Hull	3D 300W/Downvision 600W Conical 900W	50 / 200	25 Pin	4 lbs	<b>1582.99</b>	

## Voyager Planner Software

Voyage Planner allows you to effortlessly manage waypoints, routes and tracks between your vessel's multifunction display and your home planning PC. It also allows real-time import and export with a PC while onboard. Syncs wirelessly via SeaTalk<sup>h</sup>s (Ethernet) or the internet via a WiFi or router equipped PC or laptop. Alternatively, you can use a traditional Compact Flash (CF) or Micro SD Card (MSD) card. Voyage Planner imports and exports to Raymarine, GPX and KMZ formats.

**Compatible with:** Windows Vista, Windows 7, 8, & 10\* (Apple OSX is not supported.) \*In Windows 10, touch operation may show inconsistent behavior  
**Core features include:**

- Intuitive and lightning fast waypoint, route creation and edits
- Instant on-the-fly SeaTalk<sup>h</sup>s or WiFi sync of waypoints and routes between your Raymarine multifunction display and Voyage Planner
- Easy waypoint, route and track transfer via CF or microSD card
- Multiple charts in tab or tile view
- Distance and bearing tool
- Link digital photos to the map
- Depth soundings in feet or meters



Item **259234** Model **E112115** Ship 1 lbs **Net \$62.99**



## Element Sonar GPS Multifunction Display

Element delivers the sharpest view of the underwater world with HyperVision™ 1.2 mHz super high-resolution sonar technology. HyperVision technology takes DownVision, SideVision, and Raymarine RealVision 3D sonar to the next level of precision imaging and fish identification, letting you see structures, vegetation, and fish with photo-like clarity. Other unique features include:

- Onboard quad-core processor to deliver instantaneous chart redraw, fast response, and smooth RealVision 3D imaging
- Simple keypad controls and an angler-centric user interface so you can focus on the fish - not the helm
- An oversized waypoint key puts you on your favorite spots, and Element's RealBathy™ personal depth map generator lets you make your own high definition bathymetric maps on the fly.

### Element Key Features

- High-visibility sunlight viewable 7", 9", and 12" displays
- Compact HV-100 all-in-one transducer combines Hyper, Down, Side, RealVision and conventional CHIRP sonar channels into one simple installation
- 1.2 megahertz HyperVision sonar provides outstanding resolution up to 100' while 350 kHz Down and SideVision delivers photo-like imaging up to 600'
- Dedicated keypad controls for simple operation, plus an oversized waypoint key for marking favorite spots
- Raymarine RealBathy™ personal sonar mapping and Navionics SonarCharts Live support
- User-programmable keys allow quick access to most-used configurations
- Support for Raymarine LightHouse NC2 with Fishing Hot Spots, Navionics, C-MAP and other regional charting options
- NMEA2000 networking for VHF, engine, tanks, and heading sensor integration

Item	Model	Description	Ship	Net
261861	E70532-00-NAG	Element 7 HV (NAV Nav+ US & CAN Chart)	7 lbs	\$799.99
261864	E70532-05-NAG	Element 7 HV with HV-100 (Nav+ US & CAN)	7 lbs	949.99
261866	E70534-00-NAG	Element 9 HV (NAV Nav+ US & CAN Chart)	7 lbs	1199.99
261869	E70534-05-NAG	Element 9 HV with HV-100 (Nav+ US & CAN)	13 lbs	1349.99
261871	E70536-00-NAG	Element 12 HV (NAV Nav+ US & CAN Chart)	13 lbs	2399.99
261874	E70536-05-NAG	Element 12 HV with HV-100 (Nav+ US & CAN)	7 lbs	2549.99



VISIT [WWW.DEFENDER.COM](http://WWW.DEFENDER.COM) FOR HYPERVISION TRANSDUCERS, ACCESSORIES AND LEGACY TRANSDUCER SUPPORT

## ClearCruise™ Augmented Reality [AR]

ClearCruise™ AR is bringing enhanced on-water perception to Raymarine's family of Axiom® multifunction displays. With ClearCruise AR, Raymarine Axiom users can make smarter decisions with navigation objects overlaid directly on Axiom's high definition video display.

- Video Imagery enable by Cam210 HD Marine cameras
- Visualize marks and waypoints for easier navigation
- Recognize and respond to nearby marine traffic, especially complex navigational situations with multiple targets to consider, with color codes and instant object identification
- Active GoTo lets you quickly recognize and respond to MOB situations
- AR200 Video Stabilization Module ensures accurate display of AR data while underway
- AR200 Video Stabilization sensor works with Raymarine CAM210 and CAM220 IP cameras and Axiom multifunction displays

Item	Model	Description	Ship	Net
261768	T70452	ClearCruise CAM210 AR pack	9 lbs	\$1299.99
261769	T70453	ClearCruise CAM220 AR pack	8 lbs	1099.99
261770	E70537	AR200 Module for camera stabilization	4 lbs	499.99



## Add Thermal Analytics

When the M132 or 232 series cameras, below, are combined with Raymarine Axiom MFD's, Flir's new ClearCruise™ intelligent thermal analytics technology offers boaters an entirely new level of awareness and safety. ClearCruise provides audible and visual alerts objects such as boats, obstacles or navigation markers are identified in the scene.

### M132 ADJUSTABLE TILT MARINE THERMAL CAMERA

Use the latest Boson™ thermal core to see at night in 320 x 240 thermal resolution with 4XeZoom. Specifications: 9Hz refresh rate, 24° x 18 FOV Tilt range: (+110°, -90°) 12/24VDC 15w typical, 18W (max) H264 video stream E-Zoom: 2X Range performance: Person in the water: approximately 1500 ft, Small vessel: approximately 0.67 nm (1.3 km)



Item	Model/Description	Ship	Net
261247	E70432 M132 camera	10 lbs	\$2499.00

### M232 PAN AND TILT MARINE THERMAL CAMERA

Flir's smallest, most affordable pan and tilt thermal night vision camera. Features the latest generation Boson thermal core, with 320 x 240 resolution and 4X eZoom. M232 also uses IP technology, simplifying installation by eliminating extra cables. Specifications: 9 Hz refresh rate, 24° x 18 FOV Pan: 360° Tilt range: (+110°/-90°) 12/24 Volt DC, 15W typical, 18 W (max) H264 Video stream E-Zoom: 4X Range performance: Person in the water: approximately 1500 ft. Small vessel: approximately 0.67 nm (1.3 km)

Item	Model/Description	Ship	Net
261245	E70354 M232 camera system	10 lbs	\$3499.00

### CAM210/220 IP DAY & NIGHT MARINE CAMERAS

These rugged, high definition, day and night, network bullet IP video cameras, have high bright IR LED's for operation in total darkness. Both have Plug and play integration with Raymarine MFDs with Lighthouse II or better.



**CAM210** is great for all above deck applications and sports a bullet style with integrated suncover and its small frame size lets it be installed almost anywhere. It also has digital defog processing improves the captured image in poor weather conditions (such as smog, fog or smoke).

**CAM220** is designed for above and below deck applications its dome design provides all round selected visibility and also has a simple mechanical frame that allows the camera to be locked, rock steady, into position.

Item	Model	Description	Ship	Net
261585	E70346	CAM210IP marine camera	3 lbs	\$617.99
261480	E70347	CAM220IP marine camera	5 lbs	459.99

# B&G

## Zeus3 Multifunction Displays

The Zeus<sup>3</sup> is a complete chartplotter navigation system for blue water cruisers and regatta racers. This high-performance multifunction display features a widescreen display incorporating SolarMAX™ HD technology for brilliant daytime visibility and ultra-wide viewing angles. A high-performance processor enables responsive operation and quick chart redraw while moving, panning or zooming. Zeus<sup>3</sup> is powered by B&G software designed specifically for sailors and packed with a wide array of sail-specific functionality. See all key sailing data on a single screen with SailSteer, view laylines and tacking angles overlaid on charts, and plan more accurately with sailing time arrival estimates that factor in the realities of travel by wind. RacePanel delivers a range race-proven functionality including integration with B&G H5000 tactical systems for additional analytical and predictive capabilities. To ensure reliable control in all conditions and situations, Zeus<sup>3</sup> combines an all-weather touchscreen with a rotary dial and keypad capable of controlling all display functions. Both sets of controls can be used simultaneously, or Zeus<sup>3</sup> can be switched to non-touch mode for dependable operation under the most extreme conditions. Built-in WiFi lets you access GoFree® online services to download charts, weather information and software updates direct to your display via any WiFi internet hotspot. GoFree WiFi also lets you mirror your Zeus<sup>3</sup> screen on a compatible smartphone and control your Zeus display from a compatible tablet for an extra display that you can use anywhere on board. Built-in Insight charts start your navigation needs with the capability of adding an optional C-Map or Navionics chart MSD card. Available in 7", 9" and 12".

- Superbright SolarMAX display
- Ultra-Wide viewing angles
- All-Weather touchscreen that works when wet
- Higher resolution
- Built-in WiFi
- Full Keypad
- Integrated ForwardScan capability – just add transducer
- Sail Steer and Wind Plot pages
- Sirius Weather\* and GRIB file compatibility

\*requires WM-3 Weather Module and Sirius Subscription



Item	Model/Description	Ship	Net
261202	000-13241-001 7" Display	7 lbs	\$1299.00
261203	000-13242-001 9" Display	5 lbs	2299.00
261204	000-13243-001 12" Display	19 lbs	3499.00
261315	000-13802-001 7" Display with 4G radar	57 lbs	2999.00
D 261316	000-13803-001 9" Display with 4G radar	57 lbs	3949.00
D 261317	000-13804-001 12" Display with 4G radar	57 lbs	4999.00

Features & Comparisons	Zeus3	Vulcan 7R, 9 & 12
Sailing Specific Software	Yes	Yes
Radar Compatible	Yes	Yes
Ethernet Networking	Yes	No
Built-In WiFi	Yes	Yes
NMEA2000 Networking	Yes	Yes
NMEA0183 Networking	Yes	No
Multi Touch and Hard Key Controls	Yes	No
Insight Cartography	Yes	Yes



Vulcan 12 Display



# B&G

## B&G VULCAN Series

The B&G Vulcan series is a powerful line of all-in-one chart plotters and depth sounders for mid-sized sailboats. Vulcan incorporates B&G's forward-looking collision avoidance sonar technology for safe passage making in areas where chart accuracy is uncertain. Vulcan includes B&G 3G and 4G radar support giving the user ultimate situational awareness for passage making at night and in poor weather. Vulcan will also connect to B&G sailing instruments and autopilot systems for a fully integrated electronics package. No physical buttons and low profile mounting options makes Vulcan one of the cleanest and most integrated looking navigation devices for aftermarket installs. Combine this with an extensive set of advanced sailing software features inherited from its bigger brother, the Zeus3, and the Vulcan is the go-to standalone navigation display for the aspiring sailor. Radar bundles available on 7", 9" and 12" models.

- Easy to use multi-touch user interface
- Glass dash styling
- Super bright widescreen display
- Radar integration
- Built in WiFi connectivity
- Built in 10 Hz, high sensitivity GPS antenna
- Built in echosounder (Broadband and Chirp)
- Built in ForwardScan sonar
- Advanced NMEA2000 networking
- Fusion Link and sonicHub2 audio support
- AIS SARTs
- GRIB weather support
- H5000 system integration
- SailSteer, laylines with sailing time, WindPlot
- Adjustable page split ratios and panel layouts
- Best-in-class cartography support

## B&G Vulcan Sailing Features

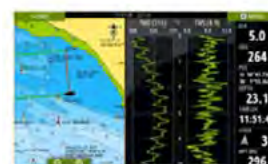

VULCAN DISPLAY				
Item	Model	Description	Ship	Net
261141	000-13214-001	Vulcan 9 FS - 9" display	9 lbs	\$1049.00
261519	000-14149-001	Vulcan 12 FS - 12" display	14 lbs	2199.00
261604	000-14079-001	Vulcan 7R with 3G radar	42 lbs	1999.00
261565	000-14156-001	Vulcan 12 FS with 3G radar	51 lbs	3399.00
261566	000-14157-001	Vulcan 12 FS with 4G radar	51 lbs	3899.00

Other models available at [www.Defender.com](http://www.Defender.com)



## NSS evo3

The NSS evo3 series is a realization of the future of fishing, the connected vessel and boating electronics. The combined styling, technology and performance push new boundaries. Navigate, take control and enjoy an unprecedented level of built-in functionality with NSS evo3. New SolarMAX™ HD display technology offers exceptional clarity and ultra-wide viewing angles combined with an all-weather TouchSensible™ touchscreen and expanded keypad for total control in all conditions. Includes Insight (AMER) cartography. Other chart options: C-MAP (Max-N, MAX-N+, Navionics Gold, Nav+ and Platinum+), Insight, Insight Genesis, NV Digital Chart (Raster US charts).

### Key Features:

- Widescreen SolarMAX™ HD display
- Take control of Simrad autopilot systems with the NSS evo3 touchscreen or keypad
- Reliable control: Switch between multi-touch and a full keypad with rotary dial
- Integrated echosounder featuring dual-channel CHIRP, ForwardScan® sonar and StructureScan® HD imaging capability
- Built-in GoFree™ WiFi
- Enjoy easier trip planning with TripIntel™ technology

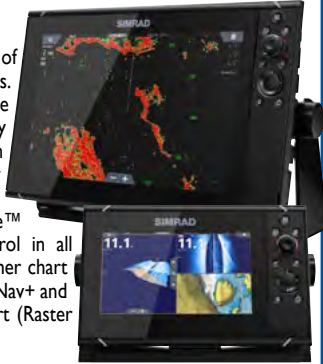

### MULTIFUNCTION DISPLAYS

Item	Model	Description	Ship	Net
261189	000-13233-001	NSS7 evo3 combo 7"	4 lbs	\$1299.00
261190	000-13234-001	NSS9 evo3 combo 9"	9 lbs	2299.00
261191	000-13235-001	NSS12 evo3 combo 12"	15 lbs	3499.00
261192	000-13236-001	NSS16 evo3 combo 16"	20 lbs	5499.00

### RADAR/SONAR PACKS

Item	Model	Description	Ship	Net
D 261193	000-13790-001	NSS7 evo3 4G radar pack	46 lbs	\$2999.00
D 261194	000-13791-001	NSS9 evo3 4G radar pack	48 lbs	3949.00
261195	000-13792-001	NSS12 evo3 4G radar pack	61 lbs	4999.00

## GO XSE Active Imaging 3-in-1 Navigation Displays



For the recreational power boater who is looking for an all in one navigation product for cruising, fishing and watersports. The GOs feature a compact size, making it an ideal choice for small runabout boats with limited dash space as well as offered in 7", 9" and 12" versions that ship with an Active Imaging 3-in-1 transducer and a C-MAP Insight Pro SD card.

Simrad GO9 XSE Multi-function display has built in Echosounder, GPS and WiFi with super-bright, multi-touch widescreen display and NMEA2000 and radar interface. Includes Active Imaging 3-in-1 transducer and a C-MAP Insight Pro card.

Item	Model	Description	Ship	Net
261849	000-14137-001	GO12 XSE with Active Imaging 3-in-1 w/ C-MAP Pro	10 lbs	\$2149.00
D 261848	000-14141-001	GO12 XSE with Active Imaging 3-in-1, C-MAP Pro + Broadband 3G radar	95 lbs	3499.00
D 261847	000-14142-001	GO12 XSE with Active Imaging 3-in-1, C-MAP Pro + Broadband 4G radar	91 lbs	3999.00
261846	000-13212-001	GO9 XSE with Active Imaging 3-in-1, C-MAP Pro	9 lbs	1099.00
D 261845	000-13763-001	GO9 XSE with Active Imaging 3-in-1, C-MAP Pro + Broadband 4G radar	95 lbs	2599.00
261844	000-14078-001	GO7 XSR with Active Imaging 3-in-1, C-MAP Pro	5 lbs	649.00
261843	000-12451-001	GO5 XSE with Active Imaging 3-in-1, C-MAP Pro	6 lbs	419.00

HDS LIVE provides premium performance and support for the best collection of innovative sonar features available – from Active Imaging™, StructureScan® 3D with Active Imaging, FishReveal™ and LiveSight™ sonar, to exciting navigation functionality like C-MAP® Genesis Live mapping.

Includes preloaded C-MAP® US Enhanced mapping with 1-foot contours on 4,000-plus lakes, C-MAP® Easy Routing, Navionics® autorouting capability and C-MAP Genesis Live mapping and will simplify your time on the water with onscreen text messages and call notifications, and an intuitive user interface.

HDS Live features a high-resolution SolarMAX™ HD screen, provides industry leading images that are always easy to see – from any angle, in direct sunlight or even through polarized sunglasses.

The high-performance, dual-core processor produces smooth, lag-free operation, responsive touchscreen performance, and faster chart redraws and sonar updates.

### Main Features:

- LiveSight: Get live views of fish movements across the bottom, in and around cover and structure with new, revolutionary LiveSight™ sonar, which is at its best when trolling at very slow speeds or fishing from a single spot
- C-MAP Genesis LIVE: Create your own high-definition 1/2" contour maps – in real time
- Smartphone notifications: Never miss an important text or call with smartphone notifications built into HDS LIVE. Turn off phone for uninterrupted fishing, or leave them on to receive popup notifications on the screen of your HDS LIVE display.

## HDSLIVE



Item	Model	Description	Ship	Net
<b>HDS LIVE</b> - Includes 3-in-1 transom mount transducer				
261757	000-14434-001	HDS-16 Live Active Image 16"	16 lbs	\$4499.00
261758	000-14428-001	HDS-12 Live Active Image 12"	16 lbs	2999.00
261759	000-14422-001	HDS-9 Live Active Image 9"	12 lbs	1799.00
261760	000-14416-001	HDS-7 Live Active Image 7"	10 lbs	999.00

## Lowrance Elite Ti2

Featuring support for Active Imaging™, FishReveal™ and built-in US inland charts and Genesis Live onscreen mapping, the Elite Ti2 fishfinder/chartplotter is big enough for use as standalone display, but has a small enough footprint to be a perfect fit for boats with limited console space. NMEA2000® engine support is featured as well as Bluetooth connectivity and built-in WiFi.

An easy-to-use touchscreen, wireless networking, smartphone notifications and trolling motor/Power Pole® integration – Elite Ti2 was designed to help you have an easier time finding fish. Available in high-resolution 7", 9", and 12" displays with wireless networking, and Active Imaging support. Compatible with Active Imaging and Sonar Hub sonar transducers and Sonic Hub2 entertainment.

### Key Features:

- Active Imaging™ 3-in-1 (CHIRP/SideScan/DownScan) ready
- Active Imaging™ 2-in-1 (SideScan/DownScan) ready
- FishReveal™ Smart Target View
- C-MAP® Easy Routing, Navionics autorouting capability
- Preloaded C-MAP US inland mapping with 1-foot contours on 4,000 lakes, plus a multitude of mapping options, including C-MAP, Navionics® and more)
- Built-in CHIRP and Broadband Sounder®
- Touchscreen control of Power-Pole® anchors, MotorGuide® Xi5 trolling motor
- Integrated wireless connectivity
- Quick Access control bar provides one-touch access to system controls



Item	Model	Description	Ship	Net
<b>Active Image 3-in-one sounder w/ Navionics+ chart</b>				
261761	000-14659-001	Elite12 Ti2 Active Image w/ TM transducer	20 lbs	\$2069.00
261762	000-14649-001	Elite9 Ti2 Active Image w/ TM transducer	9 lbs	1069.00
261763	000-14639-001	Elite7 Ti2 Active Image w/ TM transducer	8 lbs	819.00
261764	000-14635-001	Elite7 Ti2 W/ HDI TM transducer	8 lbs	669.00



# LOWRANCE®

## HDS CARBON 16" TOUCHSCREEN

### GPS CHARTPLOTTER

Item #261741

# \$2499

## Unbelievable Price!

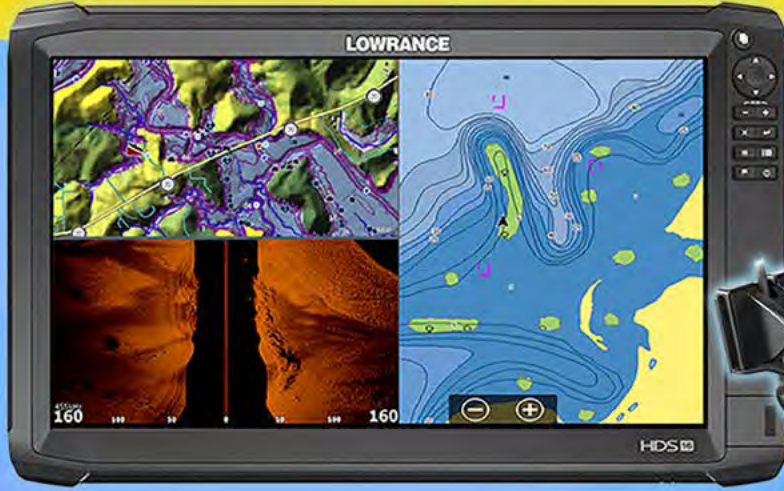

List price \$4199  
While Supplies Last!

Includes FREE:

• TotalScan Transom Mount Transducer

Exclusive at Defender!

### Lowrance HDS-16 Carbon Multifunction Display with TotalScan Transducer

- Ultra-Wide viewing angles, even with sunglasses
  - A four panel split is the equivalent of 4 7" displays on one screen
  - TotalScan transom mount transducer included featuring Broadband CHIRP, StructureScan and DownScan imaging
  - Dual-Core processor provides lightning-fast screen refreshes
  - Plug and play via NMEA2000 & 0183 capability
  - Automatic notification of software updates & troubleshooting reports to Lowrance, if needed
  - Built-in WiFi & use of the free app to view and control from a smartphone or tablet
- Item **261741**      Model **000-13735-001**      Ship 16 lbs

- **Massive 16" Display**
- **Includes Transducer**
- **Sunlight Multi-Angle Viewable Touchscreen**
- **Now Active Imaging™ capable (with software v.18.3 download)**

Net \$2499.00



# HOOK<sup>2</sup>

## HOOK<sup>2</sup>

# LOWRANCE®

Lowrance's new Hook<sup>2</sup> redefines value for boaters looking for high quality navigation and sonar at affordable prices. Hook<sup>2</sup>'s home screen features a phone like interface providing enhanced usability. Wide beam sonar, automatic settings, and the addition of SideScan capabilities, Hook<sup>2</sup> lets any angler fish like a pro. 5", 7", 9", and now, 12" screen sizes available.

- Built-in GPS antenna on all models
- Transom mount transducer included
- Navionics+ charting for USA and Canada
- 1ft HD contours for 18,000 lakes
- Smartphone-like menu system
- Wide cone angle, high chirp sonar provides 2x the sonar coverage of a normal transducer
- DownScan and SideScan capable
- Modernized industrial design
- Quick release mounting bracket on 5" models
- Split Shot transducer provides high chirp and DownScan sonar
- Triple Shot transducer provides high chirp, DownScan, and SideScan sonar
- Micro-SD card slot

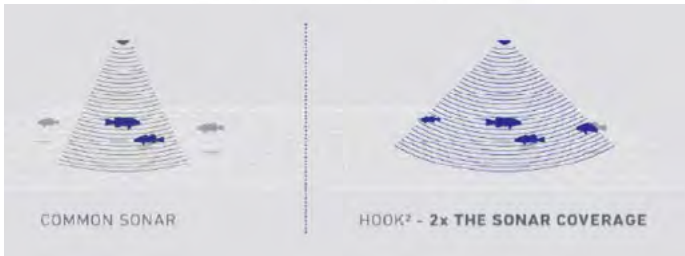

HOOK <sup>2</sup> WITH SPLIT SHOT HDI TRANSDUCER					
Item	Model	Description	Ship	Net	
261567	000-14282-001	5" display with US/Can Nav+	4 lbs	\$329.00	
	000-14290-001	7" display with US/Can Nav+	5 lbs	549.00	
	000-14298-001	9" display with US/Can Nav+	11 lbs	769.00	

HOOK <sup>2</sup> WITH TRIPLE SHOT TRANSDUCER					
Item	Model	Description	Ship	Net	
261568	000-14286-001	5" display with US/Can Nav+	4 lbs	\$429.00	
	000-14294-001	7" display with US/Can Nav+	5 lbs	649.00	
	000-14302-001	9" display with US/Can Nav+	11 lbs	869.00	

Other models available at [www.Defender.com](http://www.Defender.com)



### FishHunter

The days of having to own a boat to get quality fishfinding sonar are over. With Lowrance® FishHunter Pro, anglers fishing from the bank, dock or pier will know where to cast every time, getting 3D views from a wireless, castable transducer designed for stationary fishing. Wirelessly connect your smartphone to use as a display. Upgrade to FishHunter 3D to create custom bathymetric and structure maps.

FISHHUNTER					
Item	Model	Description	Ship	Net	
Ⓞ 261551	000-14239-001	FishHunter Pro	1 lbs	\$149.00	
Ⓞ 261552	000-14240-001	FishHunter 3D	1 lbs	199.00	



### BROADBAND 3G & 4G RADAR

Broadband 3G and 4G boasts a massive 30-50% increase in range over the original BR24 while retaining its impressive short-range credentials. Utilizing solid-state technology, this breakthrough provides superior target detection and separation, low power consumption and extremely low radiation. The revolutionary Broadband 4G™ radar offers all of the benefits of the Broadband 3G™ radar including a true 200' working range. For a new level of navigational safety:

- Target detection capability with a new 36 nautical mile range and 18 range scales to accommodate its increased performance
- Beam sharpening - enables azimuth resolution equivalent to a 3.5 ft open array radar



Item	Model	Description	Ship	Net
D 258954	000-10423-001	B&G 4G with 20 m (66') cable	37 lbs	\$1999.00
D 258952	000-10421-001	Simrad 4G with 20 m (66') cable	37 lbs	1999.00
D 258953	000-10419-001	Lowrance 4G with 10 m (33') cable	37 lbs	1899.00
D 258746	000-10422-001	B&G 3G with 20 m (66') cable	37 lbs	1499.00
D 258745	000-10420-001	Simrad 3G with 20 m (66') cable	37 lbs	1499.00
D 258747	000-10418-001	Lowrance 3G with 10 m (33') cable	37 lbs	1299.00

### 10 HZ GPS ANTENNA WITH INTEGRATED ELECTRONIC COMPASS

Excellent time-to-first-fix with 10-hertz, multi-GNSS, high-speed updates - up to 10 times per second the Navico GPS offer smoother and more accurate location updates. Note: This heading sensor is not recommended for MARPA or autopilot control! Please use the Precision 9 sensor for this. Support GPS,



GLONASS, WASS/EGNOS/MSAS and Galileo-capable.

Item	Model	Description	Ship	Net
259604	000-11043-001	Simrad GS-25 GPS antenna with integrated electronic compass	2 lbs	\$199.00
259605	000-11048-001	B&G ZG100 GPS antenna with integrated electronic compass	2 lbs	199.00
259603	000-11047-001	Lowrance Point-1 GPS antenna with integrated electronic compass	2 lbs	199.00

### STRUCTURESCAN 3D

StructureScan 3D sonar imaging system delivers a stunning three-dimensional view beneath your boat helping to understand where fish and structure are in relation to the boat.



Item	Model	Ship	Net
260580	000-12395-001	4 lbs	\$999.00

### S5100 HIGH-PERFORMANCE CHIRP SONAR MODULE

Three fully independent channels able to deliver high-resolution sonar coverage across multiple depth ranges, precision-focused for offshore sportfishing anglers.

Transducer: 3 x 9 pin X Sonic sonar connectors

Supply voltage - Operating: 9-32 Volt DC

Power Consumption: Max 85 W

Item 261327	Model 000-13260-001	Ship 5 lbs	Net \$1999.00
-------------	---------------------	------------	---------------



### DUAL FREQUENCY TRANSDUCERS

Item	Model	Best use suggestions	Type	Frequency	Material	Power	Connector	Ship	Net
259773	P66	Tried and true classic! Also provides speed and temp. An outboard fisherman's favorite	Transom Mount	50/200 kHz	Plastic	600 w	7-pin	3 lbs	\$139.99
261616	000-13942-001	"Shoot-through" transducer. No drilling or hauling required for easy installation in non-cored hulls, black connector	In-Hull	50/200 kHz	Plastic	600 w	7-pin	3 lbs	109.99
261251	B60-12-BL	Entry level through hull. Inboard and I/O boats. 12° fixed tilt	Through Hull	50/200 kHz	Bronze	600 w	7-pin	6 lbs	199.99
	B60-20-BL		Through Hull	50/200 kHz	Bronze	600 w	7-pin	6 lbs	224.99

### CHIRP TRANSDUCERS

PRICES STARTING AT									
261187	000-12728-001	HDI skimmer M/H transom mount for shallow depths. Also provides DownScan sonar	Transom Mount	M, H	Plastic		9-pin	2 lbs	\$104.99
261188	000-12569-001	HDI skimmer L/H transom mount for middle depths. Also provides DownScan sonar	Transom Mount	L, H	Plastic		9-pin	3 lbs	209.99
260928	000-12568-001	TotalScan Skimmer. All-in-one solution for NSS evo2, evo3, GO, HDS Gen3, Carbon or Elite-Ti	Transom Mount	M, H, Structure	Plastic		9-pin	4 lbs	289.99
261244	B175	Huge power and sensitivity provide pro level performance. Multiple frequency band choices.	Through Hull	L, M, H, H-W	Bronze	1000 w	None	8 lbs	915.00
261237	B785	Single band CHIRP pairs perfectly with NSS evo2 and SonarHub sounders. Includes fairing block	Through Hull	M	Bronze	600 w	None	19 lbs	693.75
261238	B285	High power, single band CHIRP perfect for NSS evo2 and SonarHub. Includes fairing block	Through Hull	M, H-W	Bronze	1000 w	None	19 lbs	1143.75
261253	B265	High performance, dual band CHIRP for BSM-3, S5100, adn NSS evo3. Includes fairing block	Through Hull	LM, LH	Bronze	1000 w	None	24 lbs	1269.00
261569	000-13771-001	High performance, dual band with WIDE beam high frequency CHIRP. Includes fairing.	Through Hull	L, H-W	Bronze	1000 w	9-pin	24 lbs	1889.99

### STRUCTURESCAN TRANSDUCERS

259192	000-10802-001	LSS-2 StructureScan transducer Provides DownScan and SideScan sonar	Transom Mount	455/800 kHz	Plastic		9-pin	3 lbs	\$219.99
260450	000-11460-001	LSS-2 StructureScan stainless through hull pair with fairing blocks	Through Hull	455/800 kHz	Stainless		9-pin	13 lbs	1099.99

FOR MORE TRANSDUCER OPTIONS VISIT: [WWW.DEFENDER.COM/SIMRAD-ELECTRONICS.JSP](http://WWW.DEFENDER.COM/SIMRAD-ELECTRONICS.JSP)

### HALO PULSE SOLID-STATE WITH PULSE COMPRESSION RADARS

**Broadband Halo Radar** Solid-State with Pulse Compression Technology Simrad Halo radar is the world's first high performance, solid-state open array radar with pulse compression technology designed specifically for light commercial and recreational marine use. Halo radar uses solid-state electronics and low-power 25 W pulsed, frequency-swept transmission bursts to deliver pulse radar-like range and resolution without the associated warm-up time, power consumption or electromagnetic emissions of magnetron radars.



**NEW!**

#### Key Features

- Advanced pulse compression technology with beam sharpening
- Simultaneous Dual Range operation sees both near and far
- VelocityTrack™ Doppler technology for collision avoidance
- Easy operation with harbour, offshore, weather, and bird modes
- MARPA target tracking (up to 10 targets, 20 in dual range).
- All new lightweight, low profile dome design, with integrated LED lights
- Includes 10 M cable, RJ45 to 5pin 1.5 M cable, RJ45 waterproofing boot

Item	Model	Description	Ship	Net
D 261779	000-14535-001	Simrad Halo 24 24" radome	37 lbs	\$2699.00
D 261781	000-14538-001	B&G Halo 24 24" radome	37 lbs	2699.00
D 261780	000-14541-001	Lowrance Halo 24 24" radome	37 lbs	2699.00

**Open Array Radar** features Blue 4 level static accent pedestal lighting. Halo™ Pulse Compression Radar's blue 4 level static accent pedestal lighting may not be approved for use in your boating location. Please check your local boating regulations before turning the blue accent lights ON.

**The Halo24 24-inch Dome radar** offers an almost real-time view, with industry-first 60 RPM operation at close range for the ultimate in collision avoidance. Identify hazards in an instant with VelocityTrack™ Doppler technology, and enjoy simultaneous short and long-range coverage—up to 48 nautical miles—from one compact 24-inch dome antenna.

#### Key Features

- Advanced pulse compression technology with beam sharpening
- Simultaneous Dual Range operation sees both near and far
- Ultra-fast 60 RPM operation at ranges up to 2nm (dome only, open array is 48RPM)
- Easy operation with harbor, offshore, weather, and bird modes
- MARPA target tracking (up to 10 targets, 20 in dual range).
- All new lightweight, low profile dome design, with integrated LED lights
- Includes Pedestal, Antenna, and RI-12 box and scanner cable

Item	Model	Description	Ship	Net
260559	000-11469-001	HALO 3 open array 3 feet	72 lbs	\$5000.00
260560	000-11470-001	HALO 4 open array 4 feet	74 lbs	5500.00
D 260561	000-11471-001	HALO 6 open array 6 feet	100 lbs	6000.00

### FORWARDSCAN™ SONAR KIT WITH SLEEVE AND PLUG

The ideal forward-looking, two dimensional echo-sounder for power and sailboat owners who want safety that comes with knowing the depth of the water. Unlike other forward-looking sounders, the ForwardScan™ can display bottom imagery up to 8 times the current depth. It integrates with your onboard NSS evo or compatible with Vulcan FS and Zeus3.



Item 260196	Model 000-11674-001	Ship 5 lbs	M.A.P. \$749.00
-------------	---------------------	------------	-----------------

There is no substitute  
for paper charts and guides.

# There is no substitute for MAPTECH®

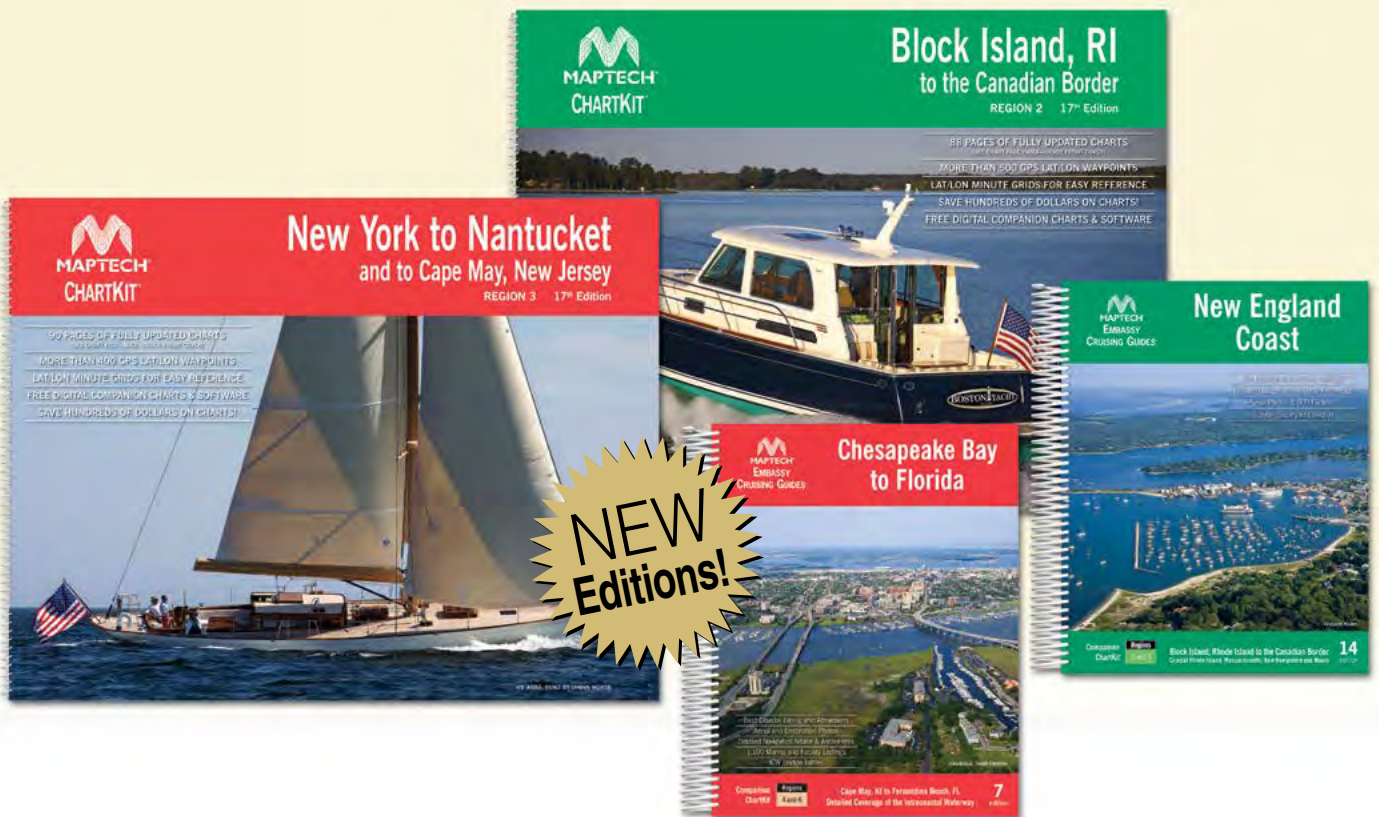

## SAFE, RELIABLE AND EASY TO USE

**ChartKit®** – Get the big picture. Go beyond the limits of digital screens with our large, 17" x 22" charts.

**Embassy Cruising Guide®** – The perfect ChartKit® companion and the most comprehensive guide available.



**MAPTECH®**

Our product family also includes electronic navigation software, digital charts, waterproof chartbooks, waterproof charts, and waterproof inland lakes and waterways maps.

SEE PAGES 222 & 230 FOR MAPTECH CHARTS & SOFTWARE





**NEW!** NavPro Series MFDs with Hybrid Touch Control, Professional Features

- These powerful MFDs give fishermen, sailors and cruisers everything they need to navigate, catch fish and safely enjoy their time on the water.
- Bright, high-resolution 9-inch and 12-inch LCD displays
  - Hybrid Touch Control - operate the system using the large touchscreen display or a combination of robust hard keys, four-directional pad or rotary knob
  - Built-in 10kHz GPS antenna
  - Built-in Wi-Fi and Bluetooth connectivity for easy important data management and software updates, allow for multiple display options and remote control of NavPro Series MFDs using a smartphone or tablet
  - Compatible with advanced C-MAP 4D cartography. US Coastal & Rivers Continental 4D card included in the package
  - Offered as Chart Plotter or with built-in CHIRP Sonar (see Models with suffix "F")
  - Available in 46-65kHz, 100-140kHz or 160kHz-200kHz CHIRP
  - Mirror Control second display and remote control via NavPro app
  - Automatic storage and synchronization of important data using free Captain Cloud data storage
  - Backed by SI-TEX's 2-Year Warranty and U.S. based customer service

Item	Model	Description	Ship	Net
261714	NAVPRO 900	9" Chart plotter	5 lbs	\$919.99
261715	NAVPRO900F	9" Chart/Fish Finder	5 lbs	1069.99
261716	NAVPRO 1200	12" Chart plotter	9 lbs	1874.99
261717	NAVPRO 1200F	12" Chart/Fish Finder	9 lbs	2029.99

TRANSDUCERS*			Starting at	
261718	95-155 kHz (chose Tilt angle 0, 12, 20°)	5 lbs	\$254.99	

\*Adapters available to allow the unit to be installed on older non-CHIRP transducers. Like 50/200 kHz Dual Frequency transducers and 120kHz Single Freq. transducers. This allows the NavPro 900F to be used to retro fit onto any of the older SI-TEX Transducers. For example any of the transducers used by legacy CVS-106 Sounders. 50/200 & 120kHz

**T-760 Radars**

The T760/761 Radar system boasts a long list of professional-grade features, including powerful 4 kW output, up to 48 nm range, multi-speed antenna rotation, standard 50-target AIS tracking capability and standard 10-target MARPA, features often associated with larger, costlier systems. Control of all these features is achieved via the T-760's touch screen LCD display and single rotary encoder dial for simple, intuitive operation.

- T-760, equipped with an 18-inch compact radome antenna for solid all-weather performance in a wide range of conditions and range scale choices from 1/8th nm to 24 nm.
- T-761 features a 24-inch radome antenna that delivers a narrower beam-width resulting in excellent target resolution and increasing the effective range up to 48 nm

**Features:**

- Multi-speed antenna rotation (16/27/36/48 rpm) for optimum target detection and tracking over a range of boat speeds
- Relative Motion, True Motion, North-Up, Head-Up and Course-Up presentation modes, Auto or Manual Sea/Rain Clutter modes, 11 Trail Indication settings (including Off and Continuous) and more
- Track up to 50 AIS targets with Input from a SI-TEX Metadata AIS module (or other AIS receivers)
- MARPA tracking of up to 10 targets at distances up to 20 nm.

**A 2 year warranty and the best technical service on the planet, this is a great value!**



Item	Model	Description	Ship	Net
D 259958	T-760	T-760 7" color LCD display with touchscreen and 18" radome	60 lbs	\$1599.99
D 259959	T-761	T-761 7" color LCD display with touchscreen and 24" radome	102 lbs	2399.99

**Explorer NavPro Black Box Multifunction Navigation System**

The compact new Explorer NavPro provides advanced C-MAP MAX-based electronic charting (on mini SD card) and a wealth of new features and functions.

**New features:**

- HDMI video output (versus the previous VGA output),
- NMEA2000 networking for engine monitoring and AIS (automatic identification system) integration
- An extremely fast and powerful processor provides quick, seamless operation, especially when panning and zooming the data-rich vector chart display
- A new user interface and file management system make it simple-to-use and easy-to-save, edit and manage data in the system's massive 4GB mark, track and route memories
- Optional RF remote control allows the Explorer NavPro to be operated wirelessly from various positions around the boat
- Two NMEA 0183 ports and a GPS smart antenna port allow for easy installation and versatile integration with other onboard systems
- The Explorer NavPro is backed by a two year warranty



DISPLAY REQUIRED				
Item	Model	Description	Ship	Net
261233	EXPLORER NavPro	Explorer NavPro Black Box Multifunction Navigator	5 lbs	\$619.99
261234	EXPLORER NavPro -W	Explorer NavPro-W Black Box Multifunction Navigator w-GPS Antenna	5 lbs	821.99
ACCESSORIES				
261081	LED222GS	Majestic Global 22" Display	11 lbs	\$459.99
261476	LED194GS	Majestic Global 19" Display	9 lbs	379.99

**SP-110C-RF3 Autopilot-in-a-Box Kit**

A complete Autopilot-in-a-Box kit that is ready to install on Boats with Cable Steering Systems. No need to convert your cable steering to expensive hydraulic steering.

**Features:**

- Control head displays Compass heading, Selected Heading and Rudder Angle information simultaneously
- Compact 4.1" x 4.1" Splash proof Control head with large easy to read Color LCD Display
- Very easy to select your desired headings, operate, and setup, via a new easy to use menu system
- High Quality Rate Gyro Compass
- Autopilot uses Input of GPS Speed over ground (SOG) and Course over ground (COG) to enhance performance
- NMEA-0183 GPS Interface accepts inputs from most Chart plotters for steering to waypoints and routes
- NMEA-0183 Output of Compass heading at 10kHz for interface to MFD's with Chart/Radar Overlay
- Autopilot Steering Modes:
  - Manual (Power Steer)
  - Auto (Pilot maintains selected Magnetic course)
  - GPS (Steers to Waypoint or Routes when Interfaced with GPS)
  - Wind (Steers to wind when interfaced to wind sensor for Sailboat installations)
- Off Course Alarm

**Specifications:**

- Control Head Dimensions: 110 mm L x 110 mm W
- Voltage supply VOLTAGE: 12/24 Volts DC
- Current consumption: 0.5 amps at 12VDC in standby mode
- Maximum Drive Output Current 15 Amps
- Data Connections: NMEA-0183 GPS Input, NMEA-0183 10kHz Compass heading Output
- Course Detection <1 Degree



Item	Model/Description	Ship	Starting at
261702	Cable Driven Autopilot and Head	28 lbs	\$1594.99

**LIKE US ON FACEBOOK**  
[WWW.FACEBOOK.COM/DEFENDERINDUSTRIES](http://WWW.FACEBOOK.COM/DEFENDERINDUSTRIES)

# Maretron®

## NMEA2000® Vessel Monitoring and Control Systems

Maretron, a world leader in vessel monitoring and control systems, designs, manufactures and markets leading edge products for commercial and recreational marine markets.

- **Safety** - Alarms for fire, smoke, combustible gases, carbon monoxide and high bilge water
- **Security** - Includes cameras, motion detectors and magnetic door and port hold sensors
- **Ease of use** - Provides one simple, common user interface for all systems
- **Remote monitoring and notification** - Includes monitoring remotely plus video, email and text notifications
- **Future support** - Easily expandable systems grow with your needs

### FULL COLOR INSTRUMENT DISPLAYS:

Connect directly to the NMEA2000 Network for custom screen configurations with the applicable sensors integrated in the network.

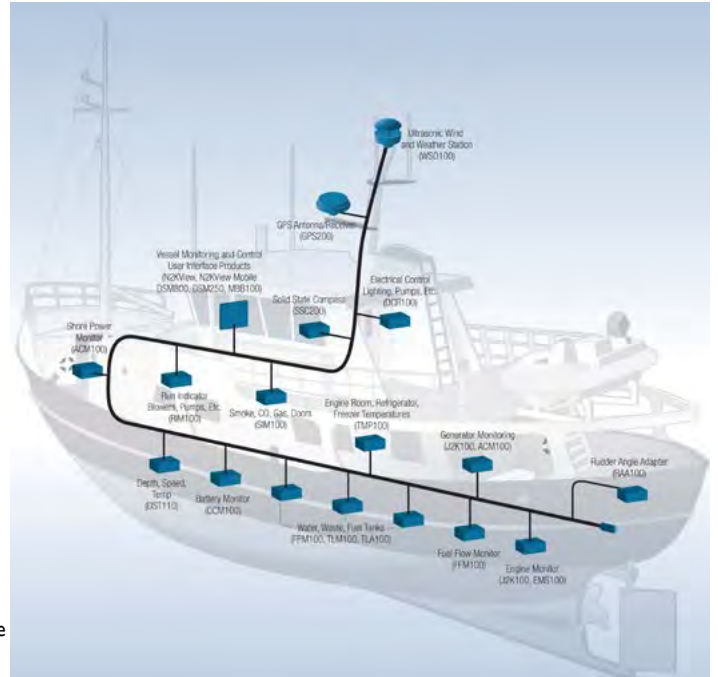

Item	Model	Description	Ship	Net
261481	DSM410-01	Maretron DSM410 NMEA2000 Multifunction 4.1" color display	1 lbs	\$494.99

### MARETRON NMEA2000 CABLE FEATURES:

- Simple trunk and drop line topology interconnects all NMEA2000 equipment and allows powered component removal or reconnection while rest of network remains operational
- Cable includes power and ground for powering equipment that draws less than 1 amp/device
- Connectors include keys and keyways for simple error free connections
- Screw thread connectors reduce chances of accidental disconnects of essential equipment
- Waterproof connection system prevents corroded intermittent connections and continues to operate even while submerged in the bilge
- Three independent cable shields (Power pair, signal pair and overall cable) protects system from external noise sources such as high power radio transmitters and radar units
- Nickel plated brass suited for a harsh environment, with screw thread connectors, reduce chances of accidental disconnects of essential equipment
- Phosphor bronze contact base material with gold over nickel plate for reliable connections
- Overmolded cable connector ends provide strain relief
- Simple, easy to use diagnostic components enable trained and untrained personnel to diagnose and troubleshoot network installations

### NMEA2000 CABLE-STARTER-KIT Connect two products together on an NMEA2000 Network

Kit includes: (1) Powertap, (2) Male terminators, (2) Tees, (2) 2 M cable, (1) 10 M cable; easy to expand - add a tee and branch cable for each additional product

Item 260049	<b>CABLE-STARTER-KIT</b>	Ship 4 lbs	<b>Net \$174.99</b>
-------------	--------------------------	------------	---------------------



Item	Model	Description	Ship	Net
257591	CGI-100	Micro bulk cable (sold per foot) - (Gray)	1 lbs	\$0.99
256430	BHF-CM-CF	Micro bulkhead feed-thru	1 lbs	26.99
260153	NGI-100C	Mini bulk cable (sold per foot) - (Gray)	1 lbs	1.79
258210	BHF-NM-NF	Mini bulkhead feed-thru	1 lbs	47.99
<b>MID CABLES</b>				
260662	DM-DBI-DF-00.5	Mid double-ended cordset - M to F - 0.5 m (Blue)	1 lbs	\$24.99
	DM-DBI-DF-01.0	Mid double-ended cordset - M to F - 1 m (Blue)	1 lbs	26.99
	DM-DBI-DF-02.0	Mid double-ended cordset - M to F - 2 m (Blue)	1 lbs	28.99
	DM-DBI-DF-03.0	Mid double-ended cordset - M to F - 3 m (Blue)	1 lbs	29.99
	DM-DBI-DF-04.0	Mid double-ended cordset - M to F - 4 m (Blue)	1 lbs	34.99
	DM-DBI-DF-05.0	Mid double-ended cordset - M to F - 5 m (Blue)	2 lbs	38.99
	DM-DBI-DF-06.0	Mid double-ended cordset - M to F - 6 m (Blue)	2 lbs	39.99
	DM-DBI-DF-08.0	Mid double-ended cordset - M to F - 8 m (Blue)	2 lbs	44.99
	DM-DBI-DF-10.0	Mid double-ended cordset - M to F - 10 m (Blue)	3 lbs	49.99
257587	CM-CF-4	Multiport box (micro-mid male homerun / micro-mid female drops)	1 lbs	79.99
260132	ELB-CM-CF	Micro/mid 90 degree male-to-female connector	1 lbs	29.99
256537	FA-CF-ST	Micro/mid field connector female	1 lbs	16.99
256429	FA-CM-ST	Micro/mid field connector male	1 lbs	16.99
256436	IT-CM-CF	Micro/mid inline terminator	1 lbs	18.99
256451	CF-SPWR05-CF	Micro/mid powertap tee female 5 m	1 lbs	41.99
<b>MICRO CABLES</b>				
260661	CM-CGI-CF-00.5	Micro double-ended cordset - M to F - 0.5 m (Gray)	1 lbs	\$22.99
	CM-CGI-CF-01.0	Micro double-ended cordset - M to F - 1 m (Gray)	1 lbs	23.99
	CM-CGI-CF-02.0	Micro double-ended cordset - M to F - 2 m (Gray)	1 lbs	25.99
	CM-CGI-CF-03.0	Micro double-ended cordset - M to F - 3 m (Gray)	1 lbs	27.99
	CM-CGI-CF-04.0	Micro double-ended cordset - M to F - 4 m (Gray)	1 lbs	29.99
	CM-CGI-CF-05.0	Micro double-ended cordset - M to F - 5 m (Gray)	1 lbs	32.99
	CM-CGI-CF-06.0	Micro double-ended cordset - M to F - 6 m (Gray)	1 lbs	34.99
	CM-CGI-CF-08.0	Micro double-ended cordset - M to F - 8 m (Gray)	2 lbs	39.99
	CM-CGI-CF-10.0	Micro double-ended cordset - M to F - 10 m (Gray)	2 lbs	42.99

OTHER CABLES, CONNECTORS AND VESSEL MONITORING AND CONTROLS ARE AVAILABLE AT WWW.DEFENDER.COM



# BRING IT ON.

Introducing the perfect marine combo.



See Pages 242-243 for More Information.



**CONTACT DEFENDER TODAY.**  
 Ask for Charlie Brown.  
[www.defender.com](http://www.defender.com)





[www.icomamerica.com/marine](http://www.icomamerica.com/marine)

©2017 Icom America Inc. The Icom logo is a registered trademark of Icom Inc. 20822

 ICOM®

# FURUNO

## Nothing Is Faster Than TimeZero for TZTouch and TZTouch 2

Equipped with powerful TimeZero™ technology, NavNet TZtouch2 and TZtouch series will completely transform the way you navigate. Scroll, pan, zoom in/out with a smooth, fast and seamless graphics engine. Navigating in a fully 3D environment offers you a true perspective and wider area of view around the ship, which allows you to better plan your route. TimeZero™ technology updates the information on your screen with virtually no redraw as you go.

Total control at your fingertips

LED backlighting pushes light through every pixel for remarkable brightness and clarity. Anti-reflective glass coating makes your display viewable in any lighting conditions. Configure your system with a wide variety of sensors, and build a navigation suite that meets all of your needs.

Freely choose the charts that fit your individual needs and preference. MapMedia's NOAA raster and vector charts for the U.S. coasts, Gulf of Mexico, Alaska and Hawaii come pre-loaded. In addition, MapMedia brings you free satellite photos and detailed fishing bathymetric charts that can be download for the U.S.

NOTE: Outside of the U.S., "C-MAP" and "Datacore by Navionics" vector cartography can be purchased and downloaded to your NavNet with ease. MapMedia cartography integrates cutting edge algorithms with high resolution image processing techniques to deliver a fusion of digital navigation charts and satellite photography. For more details and features visit: [www.defender.com](http://www.defender.com)

## DRS ANXT

### SOLID-STATE DOPPLER RADAR 6 FOOT OPEN ARRAY

The Furuno NXT Radar is the next step in Radar evolution; a Solid-State Radar with pulse compression, Target Analyzer™ and Fast Target Tracking™ utilizing Doppler technology. Combined with FURUNO exclusive RezBoost™ technology for beam sharpening, NXT packs the performance of a larger Radar in a more compact package. Includes pedestal and 10m cable. Open array sold separately.

**AVAILABLE BY SPECIAL ORDER  
PLEASE CALL 800-628-8225**



**PLEASE LIKE US ON FACEBOOK!  
FACEBOOK.COM/DEFENDERINDUSTRIES**

## 1st Watch Wireless 19" Radar Dome

Installation of this wireless compact and lightweight radar is simple. Mount it, plug in the power cord and you're done. The portability of the iOS devices this makes the system a good option for boats where space constrictions are of concern. Match the DRS4W with Nobeltec app for radar overlay onto charts. \*Requires FREE marine radar app.

### Other Features:

- 14 ranges from 0.5 to 24 NM
- Echos are color coded for quick "at a glance" echo strength for alerting you to close targets approaching
- Auto adjusts for sea clutter, gain, noise and interference
- Guard alarm zone watches for targets entering or exiting the alarm zone.
- Off center feature allows focus on specific areas around or ahead without losing track position.

Item	Model	Ship	Net
<b>D 260369</b>	<b>DRS4W</b>	46 lbs	<b>\$995.00</b>

## FM4800 Fixed Mount/FM4850 Black Box Marine VHF Radio

This the ultimate 5-In-1 tool of VHF radios, with built-in Class D DSC, GPS receiver, AIS receiver, and simplified loud hailer with intercom capability. The compact design makes it perfect for any boat, especially space constrained vessels.

**Features:** • Built-in, external GPS, or GPS through an existing source such as multifunction display capable

• Hailer with intercom, 8 patterns of alert sounds available and listen back for external sound collection

• The 4800 is remote cable  
• The FM4850 kit comes standard with one HS4800 handset, which features an LCD display, and one SP4800 speaker

Item	Model	Description	Ship	Net
<b>261731</b>	<b>FM4800</b>	Fixed mount	7 lbs	<b>\$695.00</b>
<b>261820</b>	<b>FM4850</b>	Black box	7 lbs	<b>695.00</b>



## NAVNET TZTOUCH

Item	Model	Description	Ship	Net
<b>259232</b>	<b>TZT9</b>	9" Multi-function touch screen display	21 lbs	<b>\$3795.00</b>
<b>259231</b>	<b>TZT14</b>	14.1" Multi-function touch screen display	31 lbs	<b>4995.00</b>
<b>D 259813</b>	<b>TZTBB</b>	TZTBB TZ touch black box system	36 lbs	<b>4495.00</b>
<b>260487</b>	<b>TZTL12F</b>	12.1" TZTouch2 Multi-function touch screen display	13 lbs	<b>2895.00</b>
<b>260488</b>	<b>TZTL15F</b>	15.6" TZTouch2 Multi-function touch screen display	17 lbs	<b>4295.00</b>

## DRS4D-NXT 24" Doppler Radome

The Furuno NXT Radar is the next step in Radar evolution; a Solid-State Radar with pulse compression, Target Analyzer™ and Fast Target Tracking™ utilizing Doppler technology. Combined with FURUNO exclusive RezBoost™ technology for beam sharpening, NXT packs the performance of a larger Radar in a more compact package.

Features include target analyzer, fast tracking, and REXBoost Beam sharpening, exclusive to Furuno. Includes 15m cable

Item	Model	Ship	Net
<b>D 260954</b>	<b>DRS4DNXT</b>	64 lbs	<b>\$2095.00</b>



## DRS4DL+ SINGLE WIRE RADAR SOLUTION

The DRS4DL+ is a 19" dome radar sensor for NavNet TZtouch and NavNet TZtouch2 designed with all-new functionality taken from our commercial radars. This 4kW radar is presented in a compact, rugged 19" dome with a 5.2 degree horizontal beam width antenna. Furuno's automatic, real-time digital signal processing presents navigators with some of the clearest targets they'll ever find from a radar of this compact size.

- Fast Target Tracking™/ARPA†, a function adopted from our commercial radar, instantly displays target course and speed vectors, with the press of a button. Target vectors increase situational awareness and can increase overall safety on your vessel.
- Utilizes a wired connection, compatible with NavNet TZtouch\* (TZT9/TZT14/TZTBB) and TZtouch2 (TZTL12F/15F, resulting in a very simple installation.
- Spin speed is at a fixed 24 RPM, and has range scales from 1/8 nm to 36 nm.

†Requires heading sensor

\*Not compatible with NavNet 3D.

Item	Model	Ship	Net
<b>261600</b>	<b>DRS4DL+</b>	26 lbs	<b>\$1795.00</b>

## RD33 Navigational Data Organizer

Allows the operator to select the perfect way to display data from interfaced equipment such as GPS, chartplotter, radar, fishfinder, autopilot, instruments and other sensors including engine information. The high contrast, color 4.3" LCD may be installed in a compact space, remote from its sources. Supports both CAN bus and NMEA0183 interfaces.

Item	Model	Ship	Net
<b>258442</b>	<b>RD33</b>	4 lbs	<b>\$545.00</b>



**FOR OUR ENTIRE SELECTION OF ELECTRONICS  
FROM FURUNO, PLEASE VISIT  
WWW.DEFENDER.COM/FURUNO-ELECTRONICS.JSP**



# FURUNO

## GPS Navigator GP33/39

The GPS Navigator GP33 & 39 are the perfect GPS navigators for a wide range of vessels. Big on features and performance, these advanced 4" color, LCD units provide accurate and reliable position fixing, thanks to a super sensitive, 12-channel, external GPS receiver combined with integrated SBAS (WAAS, EGNOS, MSAS) technology.

The waypoint and route data can be exported/imported via a USB flash drive or signal converter (for the GP 39) and via PC to PC (for the GP33).

Both units can be networked with a fishfinder, sonar, radar or other navigation equipment for feeding highly accurate navigation data. Both receive the TLL (Target Latitude/Longitude) sentence from networked fishfinders or sonars and can display the received information, allowing you to easily mark fish school locations.

Item	Model	Ship	Net
254831	GP33	5 lbs	\$595.00
261136	GP39	5 lbs	395.00



GP39



GP33



## BBDS1 Sounder

The BBDS1 network fishfinder for NavNet TZtouch features a bottom discrimination function as well as the FDF (Furuno Digital Filter) capability of the DFF1. The BBDS1 determines the bottom structure and separates it into the following categories: Mud, sand, gravel and rock. This is achieved by analyzing echo characteristics from the bottom components such

as particle size and hardness. Connect the BBDS1 to your NavNet TZtouch network and get ready for your NavNet system to provide you with valuable information to locate rich fishing grounds.

### Standard Features:

- Frequency: 50/200 kHz alternately • Output power: 600 W/1 kW • Power supply: 12-24 Volt DC: 1.1-0.4 A (in output power of 1 kW) • Temperature: -15 to +55° Celsius (in operation) • Relative humidity: 93% at 40° Celsius • Waterproofing: IP20 (not waterproofed)

### Required Conditions for Bottom Discrimination

- Detection range: 5-100 m • Boat speed: 0-10 knots • MFD8/12/BB software: version 2.06 or later

Item	Model	Description	Ship	Net
259544	BBDS1	Fishfinder sounder	7 lbs	\$595.00

## DFF3D Multi-Beam Sonar for NavNet TZtouch and TZtouch2

Furuno's DFF3D takes 3D fishfinding to new depths. We're talking depths of over 980 feet, with side scanning over 650 ft. See fish and bottom structure as you've never seen them before, at depths previously unfathomable. Now you can visibly see fish schools and the underwater landscape at great depths in amazing detail. The DFF3D turns your NavNet TZtouch or TZtouch2 MFD into a multi-beam sonar that can see 120-degrees port to starboard, allowing you to see the depth and direction fish schools are moving, while displaying the seabed condition in real time.

**Frequency:** 165 kHz **Power Usage:** 12-24 VDC **Range:** 300 m down - 200 m sidebar

Item	Model	Description	Ship	Net
261440	DFF3D	Network sounder	13 lbs	\$1695.00

Transducers sold separately. Visit [www.defender.com](http://www.defender.com) for a complete listing.



display into a powerful, dual-frequency digital fishfinder. Connects directly to the display or an ethernet hub with an ethernet cable. If it is connected to an ethernet hub that has multiple displays attached, each of those displays will have access to the network sounder. The unit has selectable 1, 2 or 3 kW output power and two operating frequencies from 28 to 200 kHz choices with FFS (Furuno Free Synthesis) technology. Obtain detailed echoes of bottom structure and fish. The DFF3 is a direct replacement for the BBFF3 sounder.

Item	Model	Description	Ship	Net
257235	DFF3	Network sounder	15 lbs	\$1995.00

## NAVNET TZTOUCH & TZTOUCH2 Accessories

Item	Model	Description	Ship	Net
257025	PSU012	Power supply for radars	9 lbs	\$571.99
261674	SC33	Compact dome satellite compass	13 lbs	2095.00
260483	BBWX3	Sirius/XM satellite weather receiver	3 lbs	639.99

## FCV295 LCD Sounder Fishfinder

- 10.4" "Fogging-Free" color LCD
- Output power is selectable from 1, 2 or 3 kW
- Digital filter delivers crystal clear target presentation
- Digital filter also eliminates noise to deliver sharp and detailed echo presentation
- Furuno Free Synthesizer (FFS) transceiver allows adjustable operating frequency between 28 and 200 kHz • 12-24 Volt DC

Item	Model	Description
257476	FCV295	10.4" Display



Ship	Net
25 lbs	\$2395.00

## Color Radar Systems

Easy-to-install, stand-alone, portrait view, LCD, color displays packaged with your choice of radars options.

### Display features:

- Bonded LCD provides clear view in all weather • FTT (Fast Track Targeting) • Stable AIS/ARPA target-tracking for up to 100 AIS/10 ARPA targets, with zoom display function (requires heading and AIS input) • Enhanced auto tuning/gain/anti-clutter controls • Echoes in Yellow, Green, Orange or multiple colors

Item	Model	Description	Ship	Net
D 258011	1835	10.4" Color LCD, 4 kW, 36 NM, 24" Radome	79 lbs	\$4095.00
D 261387	1815	8.4" Color LCD, 4 kW, 36 NM, 19" Radome	57 lbs	1995.00
258012	1935	10.4" Color LCD, 4 kW, 48 NM, 3.5' Open array	96 lbs	5695.00
258013	1945	10.4" Color LCD, 6 kW, 64 NM, 4' Open array	98 lbs	6495.00
256156	PG500R	Rate compensated heading sensor	4 lbs	811.99
258270	FMD1835	10.4" Color LCD second station display	24 lbs	3195.00



1835

## Monochrome Radars

**1623 Radar** Small in size, the 1623 is big on power, clarity and advanced radar features. The slim-line monochrome LCD display and lightweight radome antenna make it ideal for power or sailboats as small as 17 ft.

**1715 Radar** A high contrast LCD radar designed for pleasure craft and small fishing boats. Radar echoes are presented in four shades of Gray on the 7" Silver Bright LCD. Narrow pulse lengths and dual IF bandwidths present detailed pictures of coastline and targets at short ranges.

- Table top or panel mounting • NMEA0183 format
- Multi rotational speed adjustments based on range selection

Item	Model	Description	Ship	Net
D 254879	1623	6" Monochrome display, 2.2 kW, 16 NM, 15" Radome	32 lbs	\$1295.00
D 255125	1715	7" Monochrome display, 2.2 kW, 24 NM, 18" Radome	42 lbs	1595.00



1623

## GP1871F & GP1971F Chartplotter/FishFinder Combos

### MULTI TOUCH INTERFACE AND POWERFUL C-MAP 4D CHARTS!

The all-glass, multi touch display gives you access to every feature via convenient and intuitive slide-out menus. Everything in the menu is intuitive and contextual, so the content relates to the current display mode. The chartplotter utilizes full-featured C-Map 4D charts.

### Chart Features:

- Rich vector chart, such as relief vectors, tidal streams and marine plans, significantly boosting situational awareness.
- Creating routes and waypoints is as simple as touch-and-go.
- When connected to an AIS receiver, you can see valuable AIS data on the display.
- C-Weather-downloadable wind, wave, weather, humidity and temperature information to add to your planning.
- Built-in to the plotter is a TruEcho CHIRP, as well as a conventional fishfinder, transmitting at 300 W, 600 W or 1 kW. Simply tell the unit what transducer you are using and it will select the type of fishfinder to use.

### Sonar Features:

- TruEcho CHIRP- multi spectrum of frequencies transmissions, for vast amount of detail and clearly marking individual game fish and bait fish.
- Conventional fishfinding-with RezBoost data processing for an ultra-crisp, high-resolution picture. ACCU-FISH fish-size assessment, and bottom discrimination function to get to the most productive fishing grounds.

### Radar Features:

- Radar overlay- On the chartplotter display via wireless connection to the Furuno DR54W 1st Watch Wireless radar. The compact 19" radar dome can also display the radar presentation on a connected smart phone or tablet, offering a major upgrade in safety and versatility.

### Autopilot Feature:

- NAVpilot 300 and NAVpilot 711C – connectivity and controlled directly from the chartplotter via the CAN bus network interface.

Item	Model	Description	Ship	Net
261665	GP1871F	7" Chartplotter/Fishfinder	6 lbs	\$875.00
261666	GP1971F	9" Chartplotter/Fishfinder	6 lbs	1275.00



NEW!

**SIMRAD**<sup>®</sup>  
Go With Confidence

# Rediscover Radar

## Our Safest Radar Yet



The new HALO24 packs proven Halo™ radar performance into a compact 24-inch dome.

Avoid collisions with VelocityTrack™ technology to highlight approaching hazards, plus industry-leading

60 RPM rotation for an almost real-time view and with instant availability from standby – HALO24 is our safest dome radar yet.

[SIMRAD-YACHTING.COM](http://SIMRAD-YACHTING.COM)

**FOR MORE INFORMATION PLEASE SEE PAGE 265**



Edson's Vision Series Mounting System is a revolutionary design that provides the simplest, most attractive solution to your electronics mounting requirements.

**EASY THREE STEP ORDERING**

- 1 Select Mount Style and Height      2 Select REQUIRED Mounting Plate      3 Select OPTIONAL Light Arm/Wing/Accessories

- All new, sleek modern design
- First all modular system
- Extremely versatile
- Simple selection for any radar, dome, light or camera combination



- Easy to install
- Easy to add accessories
- Upgradable for future additions and modifications
- White powder-coated marine grade aluminum

**RADAR OR SATELLITE DOME MOUNTS - ANGLED**

- 6", 12" and 18" tall      • Aft raked 30 degrees
- Optional light arm      • Optional antenna mounting wing

Item	Model	Size	Ship	Net
258419	68010	6" Tall	4 lbs	\$228.99
258420	68020	12" Tall	12 lbs	268.99
258421	68030	18" Tall	16 lbs	328.99

Also available in 24" and 36".

**HEAVY DUTY OPEN ARRAY MOUNTS - ANGLED**

- 12" Tall      • Aft raked 30 degrees
- Optional antenna mounting wing

Item	Model	Size	Ship	Net
258423	68120	12" Tall	12 lbs	\$382.99

**MAST MOUNT PLATFORM**

- Swivel foot fits most masts      • Rivets included
- Mounting plate required

Item	Model	Ship	Net
258426	68670	12 lbs	\$386.99

**DUAL MOUNTS**

- For radar dome/sat dome or open array/sat dome
- 18" high (radar dome) and 24" high (open array)
- Aft raked 30 degrees

Item	Model	Size	Ship	Net
258424	68200	18" Tall	16 lbs	\$764.99
258425	68250	24" Tall	20 lbs	1147.99

**EDSON VISION POLE MOUNT**

- Material: Anodized aluminum      • Includes 1" rail support bracket
- Includes deck mount base flange      • Requires mounting plate

Item	Model	Size	Ship	Net
258845	67460	2-3/8" Diameter x 90" Tall	90 lbs	\$607.99



**EDSON MOUNTING PLATES**

- Powder coated, marine grade aluminum      • Required for all mounts
- | Item   | Model | Fits                                                                        | Ship  | Net    |
|--------|-------|-----------------------------------------------------------------------------|-------|--------|
| 258427 | 68500 | Universal: fits most 2/4 kW and broadband radars                            | 4 lbs | 112.99 |
| 258739 | 68510 | For Furuno 15 "24" radar domes                                              | 3 lbs | 112.99 |
| 258741 | 68590 | Also fits Si-Tex 2/4 kW Domes                                               | 6 lbs | 112.99 |
| 260912 | 68551 | Intellian, KVH (M5, TV5, and Trac 50), RAY45, Sea Tel, SeaKing Sat TV domes | 5 lbs | 112.99 |
| 601645 | 68600 | Raymarine Quantum, 2 and 4 kW radar dome                                    | 4 lbs | 112.99 |
| 254365 | 68530 | Intellian i1, i2 and i3, Sea Tel C14, KVH M1, M2, M3, TV1 and TV3           | 3 lbs | 112.99 |
|        |       | For Simrad/Lowrance/Northstar broadband and 2 kW HD radar domes             |       |        |

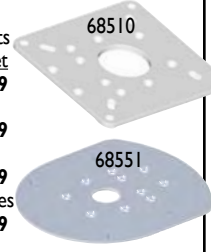

More unit specific mounting plates available at [www.defender.com](http://www.defender.com)

**ACCESSORIES**



Item	Model	Description	Ship	Net
258428	68630	Light arm receiver for angled mounts	1 lbs	\$39.99
258429	68650	Light arm for radar domes and sat domes*	2 lbs	154.99
258431	68640	Antenna mounting wing with light arm receiver for aft angled mounts	11 lbs	278.99
605741	67510	Atwood LED steaming / anchor navigation light	1 lbs	99.99
251713	67400	GPS mount with light extension	1 lbs	147.99
251718	67500	Anchor / steaming light	1 lbs	57.99

\*Receiver or wing is required to mount light arms \*\*Light sold separately

**Stainless Steel Mounts**

**STAINLESS GPS MOUNT**

Puts your handheld GPS securely and conveniently within reach on your steering pedestal guard. 3" mount is pre-drilled to fit the Garmin GPS swivel mount bracket. The arm will also accept most other round GPS brackets up to 5". Units are made to fit 1", 1-1/8" and 1-1/4" pedestals.

Item	Model	Size	Ship	Net
259606	830ST-3-100-125	3" mounting base	2 lbs	\$179.99
259607	830ST-5-100-125	5" mounting base	2 lbs	189.99

**HORIZONTAL RAIL MOUNT PLATFORMS**

- Stainless clamp-on ball mount for GPS and other accessories
- Includes poly platform for mounting
- Ideal for mounting handheld instruments on the pedestal guard
- 3" model is pre-drilled to accept Garmin's marine mount for handhelds and small chartplotters
- Fits 1", 1-1/8" and 1-1/4" tubing

Item	Model	Size	Ship	Net
252892	831ST-3-DISK	3"	2 lbs	\$125.99
252893	831ST-5-DISK	5"	2 lbs	136.99

**STAINLESS CLAMP ON ACCESSORY MOUNTS**

- Mount drink holders, instruments or nearly anything else that requires a secure location on the pedestal guard.
- For angled guards, they rotate and lock in place with set screws
- Highly polished solid 316 stainless steel construction
- Includes adapter sleeves for 1", 1-1/8" and 1-1/4" guard pipes

Item	Model	Size	Ship	Net
252894	832ST-3-125	3" platform	1 lbs	\$107.99
253171	832ST-7-125	7" platform	2 lbs	116.99

**MOUNTING HARDWARE (FITS 1", 1-1/8", 1-1/4" PIPES)**

Item	Model	Description	Ship	Net
255659	861-100-125	Clamp mount	1 lbs	\$40.99
255528	831ST-BALL	Large ball mount (use with radar cables)	1 lbs	85.99
600686	831ST-1-14	Stainless steel GPS antenna rail mount	1 lbs	107.99
259630	830ST-100-125	Stainless steel pedestal guard mounting arm	2 lbs	170.99



**Vision Series™ Instrument Housings & Mounts**

- Easily mounts to pedestal guards or consoles      • Stainless trim ring for protection
- White high-gloss thermoformed ABS housing      • UV resistant - won't fade or crack
- Mounts to 1", 1-1/8" or 1-1/4" pedestal guards      • Fits straight, angled and offset guards
- Stainless steel arm or ball-clamp required for 1-1/4" guards

**HOUSINGS FOR SQUARE SAIL INSTRUMENTS**

Item	Model	Description	Ship	Net
255234	2010-55x55	1 instrument (clamp-on mount)	3 lbs	\$233.99
255235	2020-55x55	1 instrument (side arm mount)	4 lbs	305.99
255236	2030-55x55	1 instrument (ball mount)	4 lbs	265.99



**VISION SERIES DEEP POD**

- Uncut, removable faceplate with 10.2" W x 5.72" H usable face
- Fits Raymarine Axiom 7, Garmin 7607, Simrad NSS 7

Item	Model	Included Mounts	Ship	Net
255295	2020-105X65D	(1) Side-mount arm	5 lbs	\$434.99
255282	2010-105X65D	(2) Clamp-on	6 lbs	382.99



**VISION SERIES DOUBLE INSTRUMENT HOUSING**

- Useable faceplate area: 10.2" W x 5.72" H

Item	Model	Included Mounts	Ship	Net
255238	2020-105x65	(1) Side-mount arm	5 lbs	\$405.99
255239	2030-105x65	(2) Ball mounts	7 lbs	416.99



**VISION SERIES TRIPLE INSTRUMENT HOUSING**

- Useable faceplate area: 15.4" x 4.6"

Item	Model	Included Mounts	Ship	Net
255241	2010-15x55	(2) Clamp-on	7 lbs	\$414.99
255240	2000-15x55	Housing only	5 lbs	396.99



**MEDIUM RADAR/CHARTPLOTTER HOUSING**

- Fits Raymarine Axiom 9, Axiom Pro 9, Simrad NSS 9evo3, Zeus3 9

Item	Model	Included Mounts	Ship	Net
600624	2030-10x14	(2) Ball mounts	10 lbs	\$576.99



# NAVPOD

Waterproof Housings for Marine Electronics



## ANGLE GUARD FOR SAILPODS

Item	Model	Description	Ship	Net
D 258584	AG118	AngleGuard 9.5" Wide 1.25" Single bend	36 lbs	\$240.99
D 258585	AG127	AngleGuard 9.5" Wide 1.25" Double bend	46 lbs	264.99
D 259219	AG18	AngleGuard 9.5" Wide 1" Single bend	36 lbs	200.99
D 259218	AG27	AngleGuard 9.5" Wide 1" Double bend	49 lbs	224.99
D 258586	AG218	AngleGuard 12" Wide 1.25" Single bend	36 lbs	240.99
D 258587	AG227	AngleGuard 12" Wide 1.25" Double bend	46 lbs	264.99
256715	SG10	Straight Guard 9.5" Wide 1" Straight	8 lbs	144.99
252889	SG125	Straight Guard 9.5" Wide 1.25" Straight	13 lbs	200.99

## SAILPODS FOR 9.5" GUARDS

260699	GPI900-01	Raymarine 3S95/eS97/eS98/Axiom Pro 9	5 lbs	\$352.99
261535	GPI050-15	Raymarine Axiom 12	6 lbs	344.99
260607	GPI205	Raymarine eS127 / eS128 / Axiom Pro 12	6 lbs	399.99

## SYSTEMPODS FOR 9.5" GUARDS - UN-CUT MODELS

258319	GPI040	Usable face = 17.5" W x 7.375" H	9 lbs	\$344.99
258574	GPI080	Usable face = 17.125" W x 9.125" H	7 lbs	399.99
251385	GPI170	Usable face = 20.77" W x 9.64" H	10 lbs	399.99

## SYSTEMPODS FOR 9.5" GUARDS - PRE-CUT MODELS

260609	GPI514	Raymarine eS75 / eS77 / eS78 + 1 instrument	5 lbs	\$264.99
261532	GPI500-33	Raymarine Axiom 7 + 1 instrument	5 lbs	264.99
261545	GPI040-06	Simrad Evo3/B&G Zeus3 9" + 1 instrument/IS42 & Triton2 & AP44	6 lbs	368.99
260605	GPI040-19	Raymarine eS95/eS97/eS98 / Axiom Pro 9 + 1 instrument	6 lbs	368.99
260704	GPI040-22	Raymarine eS95/eS97/eS98 / Axiom Pro 9 + space	6 lbs	368.99
260627	GPI518	Simrad GO7 / B&G Vulcan 7 + 1 instrument	5 lbs	264.99

## PRECUT CARBON FIBER FINISH POWER & PEDESTAL PODS

- Durable and reliable enclosures designed to match high-tech equipment
- Constructed out of durable ABS thermoplastic polymer
- Sports a sleek, high-gloss carbon-fiber finish and are ideally suited for inland boating and modern cruisers
- Designed to resist impacts, vibration and moisture ingress
- Manufactured with a double gasket system for a watertight seal

**NEW!**



Item	Model	Description	Ship	Net
261484	PED4400-11-C	Raymarine Axiom7 pedestal front mount*	9 lbs	\$259.99
261485	PED4600-07-C	Raymarine Axiom9 pedestal front mount*	9 lbs	343.99
261486	PP4400-11-C	Raymarine Axiom7 power front mount*	10 lbs	394.99
261709	PP4800-07-C	Raymarine Axiom9 power front mount*	5 lbs	344.99
261488	PED5050-15-C	Raymarine Axiom12 pedestal rear mount	10 lbs	368.99
261489	PP5050-15-C	Raymarine Axiom12 power rear mount	9 lbs	368.99
261599	PP5058	Lowrance HDS-12 GEN2 and GEN3 and Carbon 12	9 lbs	368.99
261612	PP4600-08-C	Lowrance HDS-9, GEN 2 & GEN3, CARBON 9	5 lbs	320.99
261598	PP4403	Lowrance HDS-7 GEN2 & GEN3 and HDS Carbon 7	4 lbs	240.99

\*Raymarine front mount kit required

## POWERPODS - PRE-CUT MODELS

Item	Model	Description	Ship	Net
258886	PP4101	Autopilots / Instruments w/ 3.6" hole	2 lbs	\$232.99
261598	PP4403	Lowrance HDS-7 GEN2 & GEN3 and Carbon 7	4 lbs	240.99
261599	PP5058	Lowrance HDS-12 GEN2 & GEN3 and Carbon 12	9 lbs	368.99
260701	PP4500-02	Raymarine eS75 / 77 / 78	5 lbs	256.99
260231	PP4404	Raymarine a75 / 77 / 78	5 lbs	240.99
260702	PP4900-01	Raymarine eS95/eS97/eS98 / Axiom Pro 9	7 lbs	379.99
261489	PP5050-15-C	Raymarine Axiom 12	9 lbs	368.99
260619	PP5205	Raymarine eS127 / eS128 / Axiom Pro	8 lbs	423.99
260643	PP4408	Simrad GO7 / B&G Vulcan 7	4 lbs	240.99
261270	PP4800	Simrad GO9 / B&G Vulcan 9	7 lbs	344.99
261531	PP4500-09	Simrad EVO3/B&G Zeus3 7	4 lbs	256.99

## INSTRUMENT PODS FOR 9.5" - PRE-CUT MODELS

260003	GPI1301	3 Instruments, 3.6" holes	4 lbs	\$264.99
260242	GPI1401	4 Instruments, 3.6" holes	6 lbs	280.99

## RAILMOUNT NAVPODS FOR 1" AND 1.25" TUBES - PRE-CUT MODELS

259089	RMX4101	Autopilots/Instruments w/ 3.6" hole	4 lbs	\$320.99
260703	RMX4500-02	Raymarine eS75 / 77 / 78	7 lbs	376.99
259557	RMX4402	Raymarine e7 / e7D	5 lbs	368.99
261533	RMX4400-11	Raymarine Axiom 7*	6 lbs	368.99
260707	RMX4900-01	Raymarine eS95/eS97/eS98 / Axiom Pro 9	8 lbs	455.99
261534	RMX4600-07	Raymarine Axiom 9*	6 lbs	429.99

\* Requires Raymarine Front Mount Kit & Right angle NMEA connector

## ACCESSORIES

257607	TPK300	Tamper-proof wrench	1 lbs	\$16.99
251780	TP125	Top plate-SS for 9.5" wide, 1.5" angleguard for Edson steering systems	2 lbs	136.99
260440	TP225	Top plate-White for 9.5" wide, 1.5" angle-guard for Lewmar/Whitlock steering systems	3 lbs	160.99

All SailPods, SystemPods and InstrumentPods are also available for 12" wide guards. Find over 200 precision pre-cut NavPods at [www.defender.com](http://www.defender.com)



Some manufacturers set M.A.P. (Minimum Advertised Pricing) for their products, so we cannot advertise a lower price. However, this does not always apply to selling price. The actual price you will be charged is probably lower. Please call us at 800-628-8225 for further details.



# SEAVIEW

**STEP 1:**  
Select mount style and height



**STEP 2:**  
Choose your modular top plate



**STEP 3:**  
Pick optional accessories such as light bars and spreader kits



PMA-57-M1



PMA-DM1-M2



## Step 1: Select Mount Type

Item	Model	Description	Ship	M.A.P.
<b>AFT LEANING FOR 18"-24" CLOSED DOME RADARS OR 16" DIAMETER OR SMALLER SATDOMES</b>				
258891	PMA-57-M1	5" Aft leaning modular mount / 7" x 7" base plate	7 lbs	\$172.00
258892	PMA-107-M1	10" Aft leaning modular mount / 7" x 7" base plate	8 lbs	196.00
<b>FORWARD LEANING FOR 18"- 24" CLOSED DOME RADARS OR 16" DIAMETER OR SMALLER SATDOMES</b>				
258901	PMF-57-M1	5" Fwd leaning modular mount / 7" x 7" base plate	7 lbs	\$172.00
258902	PMF-107-M1	10" Fwd leaning modular mount / 7" x 7" base plate	7 lbs	196.00
<b>DUAL MOUNTS</b>				
258898	PMA-DM1-M2	13.25" Dual mount for most closed dome radars and satdomes	56 lbs	704.00
258899	PMA-DM2-M2	23.75" Dual mount for open array radars up to 4.5' and satdomes	136 lbs	1040.00

## Mast Mounts

Item	Model	Description	Ship	M.A.P.
256627	SM-18-R	Mast mount for 18" Raymarine and broadband 3G/4G radars	7 lbs	\$264.00
256628	SM-18-U	Mast mount for 18" Furuno, SI-TEX, Lowrance and Koden radars	7 lbs	268.00
258922	SM-G18-U	Stainless steel guard For 12" - 20" radars (fits SM-18-R or SM-18-U)	8 lbs	\$252.00



## MAST MOUNT ACCESSORIES

SP5S				
SP2S1 / SP1S1				
SP3S with two SP1BOX				

## Uncut Sail Pods

Item	Model	Description	Ship	M.A.P.
<b>SINGLE INSTRUMENT PODS</b>				
261596	SP1S	Two options - includes 1 each SS clamp Uncut single instrument (4.63" x 4.63" useable face)	3 lbs	\$136.00
	SP1S2	Uncut single instrument (5.25" x 5.37" useable face) fits B&G Triton2 instruments*	3 lbs	148.00
<b>SMALL MFD PODS</b>				
259847	SP2S	Small multifunction display with 2 rail clamps (11.75" x 7" useable face)	7 lbs	\$232.00
259848	SP3S	Medium multifunction display with 2 rail clamps (13.75" x 9" useable face)	8 lbs	268.00
259849	SP4S	Large multifunction display with 2 rail clamps (16.938" x 12.25" useable face)	10 lbs	308.00
259850	SP5S	3 Instrument with 2 rail clamps (14.75" x 5" useable face)	6 lbs	224.00
<b>ADD-ON TO ABOVE:</b>				
261597	SPIBOX	Two options includes installation hardware Add-on uncut single instrument (4.63" x 4.63" useable face)	2 lbs	76.00
	SPIBOX2	Add-on uncut single instrument (5.25" x 5.375" useable face) fits B&G Triton2 Instruments*	2 lbs	84.00

\*Includes 90 degree cable connector

AVAILABLE IN PRECUT VERSIONS: VISIT WWW.DEFENDER.COM

## Step 2: Select a Top Plate

Item	Model	Description	Ship	M.A.P.
258903	ADA-R1	Modular plate for closed dome and open array radars	5 lbs	\$96.00
260548	ADA-HALO3	Simrad Halo open array radar adapter plate (MUST BE USED WITH ADA-R1) Modular plate for mounts ending in <b>M1</b> to fit KVH M1/M2/M3/TV1/TV3, Intellian i1/i2/i3, Raymarine 33/37STV ending in <b>M2</b> to fit KVH M2/M3/TV3, Intellian i3, Raymarine 37STV	5 lbs	76.00
258905	ADA-S1	Modular plate for mounts ending in M1 or M2 to fit KVH M5/ M7/TV5/TV6, Intellian i4/i5/i6/d6, Raymarine 45/60STV	5 lbs	116.00
258906	ADA-S2	Modular plate for mounts ending in M2 to fit KVH M1/TV1, Intellian i1/i2, Raymarine 33STV	11 lbs	168.00
258907	ADA-S3	Modular plate for mounts ending in M1 or M2 to fit FLIR M or Ray T series thermal cameras	8 lbs	168.00
258909	ADA-F1	Modular plate for mounts ending in M2, fits FLIR M1000 or 2000 thermal cameras	4 lbs	136.00
261430	ADA-F2	Modular plate for mounts ending in M2, fits FLIR M1000 or 2000 thermal cameras	5 lbs	144.00



## Step 3: Select Optional Accessories

Item	Model	Description	Ship	M.A.P.
<b>LIGHT / GPS BARS (MUST ALSO ORDER A LIGHT BAR TOP BELOW)</b>				
258910	LTB-R	Light bar for closed dome radars	4 lbs	\$96.00
258911	LTB-S	Light bar for 20" diameter or smaller satdomes, folds 90°	4 lbs	160.00
<b>LIGHT BAR TOPS</b>				
258934	LTB-U1A	Universal light bar top for mounting your own light and or GPS	1 lbs	\$48.00
258914	LTBP-1197	Perko 1197 light with 7' of wire USCG approved for boats up to 20 m	1 lbs	60.00
258915	LTBA-7800	Attwood LED 7800 Ser. light with 7' of wire - USCG approved for boats up to 20 m	1 lbs	104.00
261858	LTB-U1A7800	Light bar top comes with the Attwood 7800 LED light and threads for GPS	1 lbs	189.99
261857	LTB-U1A1197	Light bar top comes with the Attwood 7800 LED light and threads for GPS	1 lbs	140.00
<b>ACCESSORIES</b>				
258918	SPI-MOD	Spreader kit for radar or satdome applications (fits modular parts ending in <b>M1</b> )	10 lbs	\$356.00
258919	SP2-MOD	Spreader kit for radar or satdome applications (fits modular parts ending in <b>M2</b> )	13 lbs	364.00
256307	PM-W4-7	4° Wedge - 7" x 7" or 8" x 8" radar base plate	2 lbs	60.00
258921	PM-W4-10	4° Wedge for 10" x 10" radar mount base plate	3 lbs	80.00

## Seaview Cable Glands

All Ship 1 lbs  
Guaranteed and proven watertight installation for your currently installed cables. No need to re-run your cables, simply install with your cable in place!  
**All cable glands feature:** • Rubber seal flush with cover to prevent unwanted build-up • Several cover options to choose from (custom finish is also an option) • Improved base gasket • Cables can be quickly removed if needed • Connections do not need to be cut • Strong impact resistant low profile design with no sharp edges



Item	Model	Description	M.A.P.
261606	CG20PG2	<b>Retrofit cable glands</b>	\$17.60
	CG30PG2	<b>Gray color only</b> For cables up to 0.39" (10 mm) For cables up to 0.59" (15 mm)	
261067	CG20A-B Black	<b>Small deck seal</b> for connectors up to Ø 20 mm (0.81"). Single cable from Ø 2-10 mm (0.08" - 0.39")	28.00
	CG20-SS SS		27.20
	CG30P-G Gray	<b>Medium deck seal</b> for connectors up to Ø 31mm (1.25"). 1 or 2 cables from Ø 2-15 mm (0.08" - 0.59")	17.60
	CG30A-B Black		34.40
	CG30-SS SS		29.60
	CGM17P-G Gray	<b>Multi deck seal</b> for connectors up to Ø 17 mm (0.67"). Cables from Ø 2-17 mm (0.08" - 0.67")	31.20
	CGM17A-B Black		52.00
	CGM17-SS SS		Net 54.99

## Sail Mounts

### SELF-LEVELING MAST MOUNTS

**Backstay Mounts - For 2kW / 4kW radomes** For Raymarine, Garmin and Navico BR24 and 3/4G

Please specify for backstay and mast mounted: Forward or Aft

Item	Model	Description	Model	Description	Ship	Net
251925	LMB-F1	Forward	LMB-A1	Aft	26 lbs	\$1349.99

For all other models

251936	LMB-F2	Forward	LMB-A2	Aft	24 lbs	1349.99
--------	--------	---------	--------	-----	--------	---------

### ACCESSORIES

Item	Model	Description	Ship	Net
260183	LMB-EXTSHORT*	0.6 m extension kit for LMB mounting pole	5 lbs	\$214.99
257244	LM-GPS	Single GPS/VHF antenna mount (all models)	1 lbs	79.99

\* Extension Kits include joiner and fastening kit.

### Mast Mounted - For 2kW / 4kW radomes

Item	Model	Description	Ship	Net
257478	LMM-1	For Raymarine, Garmin and Navico BR24 and 3/4G	10 lbs	\$799.99
257820	LMM-2	For all other models	5 lbs	799.99

### Self-Leveling Pole Mounts\* - For 2kW / 4kW radomes

Item	Model	Description	Ship	Net
D 257710	LMP-1	2.5 m SC100 for Raymarine, Garmin, Navico BR24 and 3/4G	90 lbs	\$1777.99
D 257479	LMP-2	2.5 m SC100 Pole mount (all other models)	90 lbs	1679.99

\* Includes base, pole, leveling cradle, 1200 mm deck strut and 25 mm rail stand off

### FIXED MOUNTS (NON-LEVELING)

#### SC 100 Fixed Pole Mounts\* - For 2kW / 4kW radomes

Item	Model	Description	Ship	Net
260399	SC101	6'4" Pole system for Raymarine, Garmin and Navico BR24 and 3/4G	90 lbs	\$1144.99
D 255980	SC102	8'3" Pole system for Raymarine, Garmin and Navico BR24 and 3/4G	90 lbs	1079.99

#### Fixed Mast Mounts

Item	Model	Description	Ship	Net
255968	M92698	Mast mount for Raymarine 18" radomes	6 lbs	\$369.99
255967	M92722	Mast mount for Raymarine 18" radomes	5 lbs	299.99
255965	SC12	Mast mount - medium for 18" radomes	3 lbs	259.99
255964	SC18	Mast mount - small for 12" radomes	3 lbs	259.99
257640	SC20	Mast mount for 18" Garmin radome, Navico BR24 and 3/4G and TV3/ Raymarine 37 STV/Intellian i3/Raymarine Quantum	6 lbs	279.99
258552	SC21	Mast mount for 24" radomes	6 lbs	299.99

\* Includes adjustable base, pole, top for radome / satcom, 1200 mm deck strut and 25 mm rail stand-off

## Power Mounts

### Aluminum Power Tower

Item	Model	Description	Ship	Net
260575	APT-150-01	6", for 2/4 kW Raymarine, Garmin and Navico	7 lbs	\$296.99
260576	APT-250-01	10", for 2/4 kW Raymarine, Garmin and Navico	7 lbs	305.99

### ACCESSORIES - all aluminum powder coated to match APT Series

260577	APT-LB-01	Central light bar with Easy-Fit mount system	4 lbs	91.99
260578	APT-GPS-01	Central antenna bar (single antenna), thread: 1" x 14 TPI	3 lbs	91.99
260579	APT-LB-GPS2-01	Central bar and wing plate for (2) antenna and (1) navlight	2 lbs	174.99
261154	WD-OPNARY-01	Scansstrut 4 DEG base wedge for open array	2 lbs	122.99
261155	WD-RAD-01	Scansstrut 4 DEG base wedge for radome	2 lbs	122.99

### Dual Power Towers

#### FOR OPEN ARRAYS FOR 2KW/4KW RADOMES

Item	Model	Radar	Ship	Net
D 261808	DPT-OA	Dual Power Tower Strut (Open Array)	71 lbs	\$556.99
D 261809	DPT-R	Dual Power Tower Strut (Dome)	43 lbs	457.99
	DPT-OA-PLATE-01	For all Open Arrays	12 lbs	108.99
	DPT-C-PLATE-01	Camera plate1-Flir M & Searchlights	9 lbs	125.99
	DPT-C-PLATE-02	Camera Plate2-Flir M100/200	12 lbs	125.99
	DPT-R-PLATE-02	Radar Plate2-Furuno domes	9 lbs	74.99
	DPT-R-PLATE-01	Radar Plate1-Ray, Gar & Navico domes	12 lbs	74.99
	DPT-S-PLATE-01	Satcom Plate1-up to 30cm (12")	9 lbs	96.99
	DPT-S-PLATE-02	Satcom Plate2-up to 45cm (17")	12 lbs	135.99
	DPT-S-PLATE-03	Satcom Plate3-up to 60cm (24")	14 lbs	220.99
261810	DPT-LB-01	Central Lightbar-use with up to 45cm domes	10 lbs	169.99
	DPT-LB-02	Central Lightbar-use with up to 60cm domes	15 lbs	185.99

### Tapered mast

Item	Model	Description	Ship	Net
D 258683	PTM-R1-1	For lights, cameras, GPS / VHF antenna plus Raymarine/Garmin/Navico 3G / 4G radome	86 lbs	\$1257.99
D 258684	PTM-R1-2	For lights, cameras, GPS / VHF antennas plus radars not named above	77 lbs	1257.99

### ACCESSORIES

255984	SC110	Nav light mount - fits Perko 0455/0466, Aqua Signal series 25 and 40 (port)	2 lbs	134.99
255985	SC111	GPS / VHF / Navtex antenna mount (starboard)	2 lbs	144.99
255986	SC112	GPS / VHF / Navtex antenna mount (port)	2 lbs	134.99
255987	PT3010	4° Base Wedge for aluminum and composite PowerTower®	1 lbs	84.99

## Satcom, Camera PowerTower

Item	Model	Description	Ship	Net
256110	SC45R	For Raymarine 45 SATELLITE TV	5 lbs	\$269.99
257468	SC35	For KVH M3 / TV3, Raymarine	3 lbs	224.99
258544	CAM-MM-01	For Raymarine and FLIR thermal cameras	3 lbs	269.99
258686	TB-01	T Bar-GPS / VHF antenna mount - for 4 antennas	4 lbs	319.99

Power Tower for Satcom, Cameras



Scanstrut® offers a comprehensive range of off-the-shelf installation solutions for every type of marine electronics. From mounting a radar on your yacht to a satcom antenna on your powerboat, Scanstrut has a choice of solutions that ensure a quick, easy and great looking installation. Scanstrut products are fully endorsed and recommended by all leading marine electronics manufacturers.



Self-Leveling Mounts



Self-Leveling Pole Mounts



Dual Self-Leveling Pole Mounts

Note: Available at [www.defender.com](http://www.defender.com)



Fixed Mast Mounts



Power Mounts



Accessory Bars



Dual Power Mounts



COMING SOON NEW SCANPODS  
VISIT.DEFENDER.COM/SCANSTRUT.JSP FOR DETAILS.



## 6-Series Light Duty, Small Case Alternators

### EXTERNALLY REGULATED WITH INTERNAL BACK-UP REGULATOR

These alternators deliver high output charging capacity in a package that is tailor made for simple, trouble-free installation on most popular marine engines. The patented "Smart Ready®" internal regulator provides an additional assurance of dependability. These internally fanned alternators are available in many different configurations. They are single output and ignition protected to USCG, ISO and SAE standards ensuring safe operation on gas or diesel engines.

- Smart Ready® internal regulator
- Meets USCG, ISO, SAE J1171 standards
- Model 621 features 1"-2" single foot (spindle)
- Model 60 features 3.15" dual foot (saddle)

To order pulley designations, add suffix to the model number: **SV, DV, K6** or **J10**

- **SV** for 1/2" single vee
- **DV** for 1/2" dual vee
- **K6** for K-6 serpentine
- **J10** to pair with AltMount® serpentine pulley conversion kits



2 year manufacturer's limited warranty

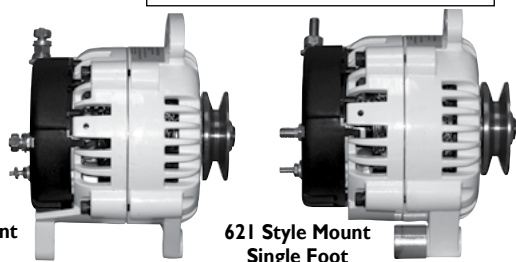

60 Style Mount Dual Foot

621 Style Mount Single Foot

6-Series Output	Power Take Off	Mounting	Individual Alternator Model			Alternator Kit w/ARS-5 Regulator			Alternator Kit with Max Charge Regulator					
			Item	Ship	M.A.P.	Item	Ship	M.A.P.	Item	Ship	M.A.P.			
70 A	2.8 HP	1-2" single foot	260756	621-70-xx	14 lbs	\$614.00	260768	621-VUP-70-xx	17 lbs	\$822.00	260771	621-VUP-MC-70-xx	17 lbs	\$851.00
		3.15" saddle	260751	60-70-xx	14 lbs	614.00	260761	60-YP-70-xx	17 lbs	822.00	260764	60-YP-MC-70-xx	16 lbs	851.00
100 A	4.0 HP	1-2" single foot	260757	621-100-xx	14 lbs	688.00	260769	621-VUP-100-xx	17 lbs	896.00	260772	621-VUP-MC-100-xx	17 lbs	925.00
		3.15" saddle	260752	60-100-xx	15 lbs	688.00	260762	60-YP-100-xx	17 lbs	896.00	260765	60-YP-MC-100-xx	17 lbs	925.00
120 A	4.8 HP	1-2" single foot	260758	621-120-xx	15 lbs	766.00	260770	621-VUP-120-xx	17 lbs	974.00	260773	621-VUP-MC-120-xx	17 lbs	1003.00
		3.15" saddle	260753	60-120-xx	15 lbs	766.00	260763	60-YP-120-xx	17 lbs	974.00	260766	60-YP-MC-120-xx	16 lbs	1003.00
150 A	5.2 HP	1-2" single foot	260759	621-150-xx	15 lbs	904.00								
		3.15" saddle	260754	60-150-xx	15 lbs	904.00								
70 A, 24V	5.6 HP	1-2" single foot	260760	621-24-xx	14 lbs	904.00				260774	621-VUP-24-70-xx	17 lbs	1161.00	
		3.15" saddle	260755	60-24-xx	14 lbs	904.00				260767	60-YP-24-70-xx	17 lbs	1161.00	

"XX" Pulley Designations: "SV" = 1/2" Single Vee, "DV" = 1/2" Dual Vee, "K6" = K-6 Serpentine, "J10" = J-10 AltMount® Serpentine.

PLEASE VISIT [WWW.DEFENDER.COM](http://WWW.DEFENDER.COM) FOR 6-SERIES CHARGING SYSTEM PACKAGES AND DETAILED SPECIFICATIONS ON BALMAR PRODUCTS.

## XT-Series and AT-Series Alternators

New AT (Advanced Technology) series alternators deliver the highest possible output in a small-case alternator package. Scaled to fit most original-position installations, 128 mm 170A XT-series alternators are available in 1-2" single foot and 3.15" dual foot mounting styles. Larger output, 200A AT-Series alternators are housed in a 139 mm diameter frame and can also be provided with a 4" dual foot mount. XT-Series and AT-Series alternators are designed to be used with Max Charge MC-614 voltage regulators and should only be used in dual vee belt or multi-groove serpentine belt applications.

New AltMount® serpentine pulley kits provide the ability to upgrade many engine models to support the XT/AT-Series. Alternator kit packages include: the selected alternator, the latest Max Charge regulator (MC-614-H regulator w/ harness) and a temperature sensor for both the alternator (MC-TS-A) and battery (MC-TS-B).

- Voltage: 12 Volt DC

To order Pulley Designations add suffix to the model number: **DV, K6** or **J10**

- **DV** for 1/2" dual vee
- **K6** for K-6 serpentine
- **J10** to pair with AltMount® serpentine pulley conversion kits



2 year manufacturer's limited warranty

AT-Series Output	Power Take Off	Mounting	Individual Alternator Model*			Alternator Kit with Max Charge Regulator				
			Item	Ship	M.A.P.	Item	Ship	M.A.P.		
170 A	5.2 HP	1-2" single foot	202517	XT-SF-170-xx	20 lbs	\$984.00	202519	XT-SF-170-xx-KIT	24 lbs	\$1220.00
		3.15" saddle	202518	XT-DF-170-xx	20 lbs	984.00	202520	XT-DF-170-xx-KIT	24 lbs	1220.00
200 A	6.0 HP	1-2" single foot	260776	AT-SF-200-xx	18 lbs	1323.00	260780	AT-SF-200-xx-KIT	22 lbs	1641.00
		3.15" saddle	260778	AT-DF-200-xx	18 lbs	1367.00	260782	AT-DF-200-xx-KIT	22 lbs	1713.00

"XX" Pulley Designations: "DV" = 1/2" Dual Vee, "K6" = K-6 Serpentine, "J10" = J-10 AltMount® Serpentine.



## ARS-5-H Multi-Stage Regulator

- 8-stage smart charging: bulk, absorption and float modes
- Enhanced settings optimize charging based on battery type, belt size and alternator output
- Alpha-numeric LED display shows performance data and makes programming easy
- Selectable preset programs for battery type: deep cycle lead acid, gel, absorbed glass mat and spiral wound (Optima)
- Install optional battery and alternator temperature sensors for enhanced regulator performance
- Compatible with Balmar high output alternators and other externally regulated P-type alternators



Item	Model	Volts	Ship	M.A.P.
250488	ARS-5-H with 54" wiring harness*	12	2 lbs	\$299.00
250483	ARS-5 without wiring harness	12	1 lbs	280.00

\*Includes 54" wiring harness, programming screwdriver and installation instructions

## Digital Duo Charge

- Second battery charging system eliminates the need for a battery isolator
- Solenoid drive provides control for an external solenoid (sold separately)
- Battery temperature sensing with optional MC-TS-B
- Remains in sleep mode when the voltage at the house battery is lower than 13/26 Volt DC
- When voltage rises past 13/26 Volt DC, it delivers up to 30 A charging current to battery



Item	Model	Volts	Ship	M.A.P.
204360	DDC-12/24	12/24	2 lbs	\$232.00

## Max Charge Multi-Stage Voltage Regulator

- Recently upgraded and provides an 8-stage smart charging system that's effective and easy to use
- Preset charging programs for 8 marine battery types
- Ability to program discrete settings for a wide variety of charging functions, providing complete control over how batteries are charged
- Separate sense wire allows accurate battery condition monitoring
- Belt load manager - enables user to selectively reduce field output, lessening stress on engine and drive belts
- Adding optional alternator and battery temperature sensors assures optimal protection for alternator and batteries as well as voltage compensation based on ambient battery temperature
- Bright 3-Digit LED display



Item	Model	Volt DC	Ship	M.A.P.
203797	MC-614-H	12	2 lbs	\$328.00
203798	MC-624-H	24	2 lbs	386.00
202294	MC-612-DUAL-H	12	3 lbs	376.00

(MC-612-Dual controls 2 alternators on a single engine)

## Temperature Sensor (TS-A and TS-B)

- Designed to aid your regulators in maximizing charging efficiency and insure your electrical system is operating safely
- Alternator temp sensor will automatically reduce field voltage when over-temperature conditions exist
- Battery sensor enables voltage regulator to increase or decrease charge rate based on internal battery temperature



Item	Model	Ship	Net
200190	MC-TS-A Alternator temp sensor - 54"	1 lbs	\$38.99
200191	MC-TS-B Battery temp sensor - 240"	1 lbs	47.99

**Sportsman Marine Batteries – Starting, Dual Purpose, Deep Cycle** 18-MONTH FREE REPLACEMENT WARRANTY**SPORTSMAN**

Our best-selling wet-cell marine battery! Made in the USA, these batteries are engineered to withstand the toughest marine environments. Available in 12 and 6 Volts DC, they provide long service life and excellent value.

Item	Model	Type	VDC	Group	CCA/MCA	AH	RC	Dimensions (L x W x H)	Ship	Net	
⚠	201411	24M600	Starting	12	24	550 / 675	75	90 min.	10.5" x 6.75" x 9.38"	37 lbs	\$109.99
⚠	204460	24M1000	Starting	12	24	800 / 1000	95	130 min.	10.5" x 6.75" x 9.38"	45 lbs	148.99
⚠	204685	27M1000	Starting	12	27	840 / 1050	105	182 min.	12.5" x 6.75" x 9.38"	57 lbs	164.99
⚠	201414	XH4D	Starting	12	4D	1050 / 1290	160	290 min.	20.75" x 8.50" x 10"	102 lbs	274.99
⚠	201415	XH8D	Starting	12	8D	1425 / 1755	180	440 min.	20.75" x 11" x 10"	132 lbs	309.99
⚠	204698	DP24M	Starting/Cycling	12	24	550 / 675	65	130 min.	10.5" x 6.75" x 9.38"	43 lbs	129.99
⚠	204697	DP27M	Starting/Cycling	12	27	650 / 800	80	175 min.	12.5" x 6.75" x 9.38"	51 lbs	149.99
⚠	204696	DP31M	Starting/Cycling	12	31	700 / 860	100	205 min.	13" x 6.75" x 9.5"	58 lbs	184.99
⚠	200206	DC24	Deep Cycle	12	24	500 / 615	75	140 min.	10.5" x 6.75" x 9.38"	42 lbs	145.99
⚠	201412	DC27	Deep Cycle	12	27	575 / 705	90	200 min.	12.5" x 6.75" x 9.38"	53 lbs	164.99
⚠	201413	DC31	Deep Cycle	12	31	650 / 800	105	225 min.	13" x 6.75" x 9.50"	63 lbs	199.99
⚠	201040	DC4D	Deep Cycle	12	4D	1000 / 1250	200	375 min.	20.75" x 8.50" x 10"	102 lbs	329.99
⚠	201050	DC8D	Deep Cycle	12	8D	1100 / 1375	225	450 min.	20.75" x 11" x 10"	135 lbs	389.99
⚠	204342	GC-4	Deep Cycle	6	GC2	640 / 800	225	400 min.	10.25" x 7.12" x 10.88"	61 lbs	199.99



Avoid costly freight fees!  
Ensure availability: Call us at  
800-628-8225 to place the order  
for store pickup at Defender - conveniently  
located between Boston and NYC.

**Power-Tec Dual Purpose AGM Batteries**

18-MONTH FREE REPLACEMENT WARRANTY

These batteries offer premium starting performance and advanced deep cycle service for marine applications. Made in the USA, these batteries have 2x the cycle life of conventional designs with 20x the vibration resistance. The micro-porous glass separators protect internal components and provide a spill-proof design for flexible installation. 100% maintenance free.

Item	Model	VDC	Group	CCA/MCA	RC	AH	Dimensions (L x W x H)	Ship	Net	
⊕	204141	8AU1H	12	U1	200 / 240	48 min.	32	8.31" x 5.13" x 7.25"	24 lbs	\$134.99
⊕	204142	8A22NF	12	22	350 / 420	85 min.	55	9.38" x 5.5" x 9.25"	39 lbs	209.99
⊕	204143	8A24M	12	24	525 / 800	135 min.	79	10.88" x 6.75" x 9.88"	53 lbs	274.99
⊕	204144	8A27M	12	27	580 / 900	175 min.	92	12.75" x 6.75" x 9.88"	63 lbs	314.99
⊕	204145	8A31DTM	12	31	800 / 1000	200 min.	105	12.94" x 6.75" x 9.38"	69 lbs	339.99
⚠⊕	204146	8A4DM	12	4D	1110 / 1420	380 min.	198	20.75" x 8.5" x 10"	133 lbs	599.99
⚠⊕	204147	8A8DM	12	8D	1450 / 1800	480 min.	245	20.75" x 11" x 10"	155 lbs	714.99

**NorthStar Ultra High Performance Marine AGM Batteries**

3-YEAR FREE REPLACEMENT WARRANTY

Delivers superior cranking, unrivaled cycling and faster recharge. Pure Lead AGM technology delivers the highest CCA ratings and reserve capacity available. Cycles over 900 times to 50% depth of discharge - the best deep cycle battery available. Faster recharge than conventional batteries. Proudly made in the USA!

Item	Model	VDC	Group	CCA/MCA	RC	AH	Dimensions (L x W x H)	Ship	Net	
⊕	202295	NSB-AGM24M	12	24	840 / 1010	160 min.	76	10.87" x 6.77" x 8.86"	60 lbs	\$344.99
⊕	202296	NSB-AGM27M	12	27	930 / 1080	195 min.	92	12.41" x 6.77" x 8.86"	69 lbs	379.99
⊕	202297	NSB-AGM31M	12	31	1150 / 1370	220 min.	103	12.91" x 6.77" x 9.88"	74 lbs	409.99
⊕	202298	NSB-AGM34M	12	34	880 / 1050	133 min.	65	10.87" x 6.75" x 7.87"	49 lbs	319.99
⚠⊕	205036	NSB-AGM8D	12	8D	1450 / 1800	500 min.	220	20.36" x 10.84" x 8.2"	152 lbs	729.99

**Lifeline Dual Purpose Sealed AGM Batteries**

12-MONTH FREE REPLACEMENT WARRANTY

Provide rapid recharge, long service life and 100% maintenance free use. Their superior cycle life and low internal resistance create high repeated cranking current.

Item	Model	VDC	CCA/MCA	AH	RC	Dimensions	Ship	Net	
⊕	204200	GPL-24T	12	550 / 680	80	149	11.13" x 6.66" x 9.25"	56 lbs	\$389.99
⊕	204201	GPL-27T	12	575 / 715	100	186	13.09" x 6.60" x 9.25"	64 lbs	429.99
⊕	204202	GPL-31T	12	600 / 750	105	195	12.9" x 6.75" x 9.27"	66 lbs	449.99
⚠⊕	204204	GPL-4DL	12	1100 / 1360	210	390	20.76" x 8.70" x 8.63"	128 lbs	779.99
⚠⊕	204206	GPL-8DL	12	1350 / 1675	255	475	20.76" x 10.89" x 8.60"	159 lbs	929.99
⊕	204338	GPL-4CT	6	750 / 925	220	492	10.28" x 7.06" x 9.92"	68 lbs	474.99
⚠⊕	204648	GPL-6CT	6	925 / 1025	300	692	10.28" x 7.06" x 12.94"	89 lbs	559.99

**OPTIMA 12 VDC AGM Batteries**

2-YEAR FREE REPLACEMENT WARRANTY

Spill-proof Optima BLUETOP® high-performance AGM batteries provide exceptional running time, superior starting power and high recharge rates. The dual purpose battery's advanced deep cycle capabilities are ideal for a variety of marine applications.

Item	Model	Description	CCA/MCA	AH	Ship	Net	
⊕	204148	34M	Blue Top marine starting	800 / 1000	50	40 lbs	\$279.99
⊕	204150	D34M	Blue Top dual purpose	750 / 870	55	44 lbs	299.99
⊕	205104	D27M	Blue Top dual purpose	800 / 1000	66	54 lbs	334.99
⊕	205105	D31M	Blue Top dual purpose	900 / 1125	725	60 lbs	349.99



Please note:  
Specifications  
may be  
subject to  
change per the  
manufacturer.

**Gel-Tech Deep Cycle Gel-Cell Batteries**

2-YEAR FREE REPLACEMENT WARRANTY

Spill-proof, vibration resistant and 100% maintenance free. Gel-Tech batteries are ideal for house-power, providing superior deep cycle service and starting capabilities. 650 cycles at 50% depth of discharge. Longer running time, extended life and faster recharge compared to traditional wet cell batteries. Made in the USA.

Item	Model	VDC	Group	CCA/MCA	RC	AH	Dimensions (L x W x H)	Ship	Net	
⊕	200021	8G1H	12	U1	200 / 290	47 min.	32	8.31" x 5.13" x 7.25"	24 lbs	\$167.99
⊕	200023	8G24M	12	24	410 / 575	140 min.	74	10.88" x 6.75" x 9.88"	53 lbs	309.99
⊕	200024	8G27M	12	27	505 / 700	170 min.	88	12.75" x 6.75" x 9.88"	63 lbs	359.99
⊕	200025	8G31DT	12	31	550 / 780	190 min.	98	12.94" x 6.75" x 9.38"	68 lbs	389.99
⚠⊕	200026	8G4D	12	4D	970 / 1245	395 min.	183	20.75" x 8.50" x 10.00"	127 lbs	719.99
⚠⊕	200027	8G8D	12	8D	1150 / 1470	500 min.	225	20.75" x 11.00" x 10.00"	157 lbs	859.99





## Battery Boxes & Accessories

### NOCO MARINE COMMERCIAL BATTERY BOXES

Rotationally molded from a low-density polyethylene plastic. Maintains their impact properties in climates down to -20° F. Four-corner fastening system, captive lid, large cable entry holes and a large electrolyte reservoir. Meets USCG Code of Federal Regulation 183.420 and ABYC E-10.7 specifications.

Item	Model	Group	Inside L x W x H	Outside L x W x H	Ship	Net
201057	HM408	4D	21.2" x 9.6" x 11.1"	24.7" x 13" x 14"	31 lbs	\$79.99
201058	HM426	Dual 6V	14.6" x 10.5" x 11.5"	17.9" x 14.3" x 14"	31 lbs	79.99
201059	HM484	8D	21" x 11.8" x 10.3"	24.4" x 15.4" x 12.3"	30 lbs	85.99
201729	HM485	Dual 8D	21" x 23" x 10.6"	26.4" x 24.4" x 12.5"	44 lbs	135.99



### NOCO SNAP-TOP BATTERY BOXES

Manufactured from injection molded polypropylene plastic that effectively collects electrolyte, allows ventilation and prevents accidental contact of ungrounded battery terminals. Meets USCG Code of Federal Regulations 183.420 and ABYC E-10.7 specifications.

Item	Model	Group	Inside L" x W" x H"	Outside L" x W" x H"	Ship	Net
201053	HM300BK	24	10.5" x 7.2" x 9.6"	14.0" x 10.0" x 10.7"	3 lbs	\$8.49
201054	HM327BK	27	13.2" x 7.2" x 10.1"	16.9" x 9.8" x 11.5"	3 lbs	9.49
201056	HM306BK	6V	10.6" x 7.6" x 11.2"	14.1" x 10.6" x 12.4"	3 lbs	9.99
201055	HM318BK	24-31	14.0" x 7.1" x 9.6"	17.6" x 10.0" x 10.7"	3 lbs	9.99

### NOCO ACCESSORIES

Item	Description	Ship	Net
201060	38" Battery box strap	1 lbs	\$3.99
201061	Group 24 battery tray	1 lbs	6.49
201062	Group 27 or 31 battery tray	1 lbs	6.79

### NOCO GENIUS BOOST PLUS ULTRASAFE LITHIUM JUMP STARTERS

Portable lithium-ion battery jump starter pack for jump starting a dead battery in seconds

- Spark-proof connections and reverse polarity protection
- Recharges USB devices like smartphones, tablets & more
- LED status indicators display the internal lithium battery charge level and charging status
- The LED flashlight is a rechargeable, lithium-powered flashlight with seven light modes, including SOS and emergency strobe



Item	Model	Description	Starting Current	Battery Types	For Gas Engines	Joules 3S Rating	For Diesel Engines	USB Charger	LED Flashlight	Ship	Net
202501	GB20	Genius GB20 Boost Plus	400A	12V Lead-Acid	Up to 4.0L	4650	Not Recommended	Yes	100 lumens	3 lbs	\$79.99
202502	GB40	Genius GB40 Boost Plus	1000A	12V Lead-Acid	Up to 6.0L	7000	Up to 3.0L	Yes	100 lumens	4 lbs	99.95
202503	GB70	Genius GB70 Boost Plus	2000A	12V Lead-Acid	Up to 8.0L	15700	Up to 6.0L	Yes	400 lumens	6 lbs	199.95
202504	GB150	Genius GB150 Boost Plus	4000A	12V Lead-Acid	Up to 10.0L	22500	Up to 10.0L	Yes	500 lumens	9 lbs	299.95

### SW SOLAR BATTERY MAINTAINER

202505	BLSOLARS	Solar Battery Charger & Maintainer	5 lbs	49.99
--------	----------	------------------------------------	-------	-------

## Battery Switches

### MARINCO PRO INSTALLER 400 AMP BATTERY SWITCHES

- Superior installation flexibility, high power capacity and unmatched reliability
- Easy mounting into existing or new installations
- Removable knob allows isolation during servicing
- 3.85" L x 3.85" W x 3.62" H
- (3) mounting styles: surface, rear panel or front panel
- Innovative nut retention allows use of metric or imperial fasteners



Item	Model	Rating (Amps DC)			Maximum Voltage	Ship	Net
		Cont	Inter	Crank			
<b>On/Off Battery Switch</b>							
204959	770	400	600	1500	48	2 lbs	\$47.99
<b>Double Pole Battery Switch</b>							
204960	770-DP	2x400	2x600	2x1500	48	2 lbs	\$61.99
<b>Dual Bank Control Switch</b>							
204961	772-DBC	2x400	2x600	2x1500	48	2 lbs	\$64.99
<b>Selector (771-S) &amp; Selector with Field Disconnect (771-SFD) Battery Switches</b>							
204962	771-S	400	600	1500	48	2 lbs	49.99
204967	771-SFD	400	600	1500	48	2 lbs	56.99

### MARINCO/BEP DIGITAL VOLTAGE SENSING RELAY

- Safely charges (2) or more independent battery banks from one charge source
- Voltage (nominal): 12 / 24 VDC • Engages: 13.4 / 26.8 VDC
- Disengages: 12.8 / 25.6 VDC • Amperage: 125 A (cont.)/140 A (int.)



Item	Model	Dimensions:	Ship	Net
204916	710-140A	2" H x 2.75" W x 2.75" L	1 lbs	\$117.99

### MARINCO/BEP 700 EASY FIT BATTERY SWITCH

- Easily removable threaded ring allows for panel thicknesses up to 3/4"
- Can be retro-fitted in place of most European post and lever type switches
- Continuous rating - 275 Amps DC • Intermittent rating - 455 Amps DC
- Cranking rating - 1250 Amps DC • Voltage rating - 48 VDC



Item	Model	Dimensions	Operation	Ship	Net
204628	700	2.7" x 2.7" x 4.3"	On/Off	1 lbs	\$34.99

### MARINCO/GUEST BATTERY SELECTOR SWITCHES

- New ergonomically styled turn knob provides easy On/Off switching
- Updated color scheme and graphics make it easier to determine switch status
- Longer stud lengths for improved assembly and easier cable routing
- Rugged internal components protected by a tough, impact resistant polycarbonate



#### Cruiser Series

Both models: 230 continuous amps, 345 peak amps

Item	Model	Ship	Net
201518	2110A With alternator field disconnect (AFD)	1 lbs	\$40.99
201519	2111A Without alternator field disconnect (AFD)	1 lbs	33.99

#### Heavy-Duty Diesel Series

For 6, 12, 24, or 36 VDC systems. Lug size: 1/2" Dimensions: 5-1/2" Sq x 3-1/2" H

Item	Model	Cont. Amps	Momentary Amps	Ship	Net
201527	2300A	360	600	2 lbs	\$136.99
201528	2304A	600	1000	2 lbs	189.99

### COLE HERSEE MASTER DISCONNECT SWITCH

- Single pole • 6-36 VDC
- Two positions: Off/On • Two 3/8" diameter studs
- 175 A continuous, 1000 A intermittent, 15 seconds On, 5 minutes Off
- Brass case and mounting stem, chrome-plated lever
- Mounting stem 3/4-24 thread; 1-13/32" long
- Fits panels up to 15/16" thick



Item	Model	Ship	Net
204584	M-284-BP	2 lbs	\$37.99

### BLUE SEA ON/OFF BATTERY SWITCH

- Compact and easy to install, mounts to battery stud/post
- Rating - 150A continuous / 450 cranking

Item	Model	Description	Ship	Net
205051	5991	POST MOUNT	1 lbs	\$18.99
		Terminal mount	1 lbs	\$18.99



## Battery Switches & Kits



### BLUE SEA M-SERIES BATTERY SWITCHES

- Vapor proof/ignition protected
- Surface, front or flush mounting
- 300 A continuous max

Item	Model	Style	Ship	Net
205086	6004	Single circuit ON-OFF w/locking key	1 lbs	\$29.99
204496	6005	Single circuit ON-OFF w/key	1 lbs	27.99
204497	6006	Single Circuit ON-OFF w/knob	1 lbs	27.99
200801	6007	4 position selector	1 lbs	36.99
205085	6008	3 position selector	1 lbs	44.99



### BLUE SEA STANDARD BATTERY SWITCHES

3/8" tin-plated copper studs for maximum conductivity; corrosion resistant and ignition protected for safe installation aboard gasoline powered boats. Accepts up to 4/0 battery cables and fits most Perko and Guest low amperage switch hole patterns.



Item	Model	Description	Ship	Net
204371	9003E	Single circuit On/Off; (1) battery input	1 lbs	\$39.99
204372	9004E	Single circuit On/Off; (1) battery input w/ AFD option*	1 lbs	54.99
204373	9001E	(4) positions, (2) battery inputs	2 lbs	42.99
204374	9002E	(4) positions, (2) battery inputs w/ AFD option*	2 lbs	46.99
204444	3000	Heavy duty, single circuit On/Off; (1) battery input	2 lbs	75.99

\*Offers optional AFD (alternator field disconnect)

### BLUE SEA SYSTEMS ML-SERIES REMOTE BATTERY SWITCH

ML-Series remote battery switches feature a 500 A DC continuous rating that allows high-amperage switching under load, manually or from remote locations.

- Includes manual override
- Continuous rating: 500 A
- Max. operating voltage: 16.5 V for 12 V version, 32 for 24 V version
- Includes remote control switch (On)-Off-(On)

Item	Model	VDC	Ship	Net
201831	7700	12	2 lbs	\$172.99
	7702	24	2 lbs	172.99



### BLUE SEA SYSTEMS M-SERIES MINI ADD-A-BATTERY KIT

- Combines m-ACR with m-Series dual circuit plus battery switch
- Voltage: 12 / 24 VDC; designed for alternators up to 65 A
- Simplifies switching and charging for a complete 2-bank battery solution

- System includes:
  - (1) m-Series automatic charging relay (part No. 7601)
  - (1) m-Series mini dual circuit plus battery switch (part No. 6011)

Item	Model	Ship	Net
204917	7649	3 lbs	\$98.99



### BLUE SEA SYSTEMS ADD-A-BATTERY KIT

- Simplifies switching and automates charging of (2) battery banks
- Includes dual circuit plus battery switch and start isolating automatic charging relay
- Up to 120 A
- Works with 12 VDC or 24 VDC systems

- System includes: (1) 551 IE Dual Circuit Plus™ Battery Switch and (1) 7610 ACR Automatic Charging Relay

Item	Model	Ship	Net
204617	7650	3 lbs	\$129.99



## Battery Combiners & Chargers

### YANDINA TWO BANK WATERPROOF BATTERY COMBINERS

- Compact, voltage-sensing relay which connects (2) batteries in parallel when either is receiving a charge
- When charging ceases, relay opens so that each battery operates independently
- Can be used on alternators with internal or external regulators
- Waterproof – ideal for mounting in open boats
- Electronic thermal monitoring with shutdown and automatic restart
- Easy 3-wire installation – includes all required cables and terminals
- Draws no current when batteries are not being charged
- No diodes to burn out if accidentally shorted
- LED status indicator



C160

Item	Model	System	Alternator	5 Min. Closing	Ship	Net
204578	C100	12 VDC	Up to 100 A	100 A	1 lbs	\$55.99
204795	C160	12 VDC	Up to 200 A	200 A	1 lbs	98.99

### YANDINA TROLLBRIDGE24 COMBINER

- Allows you to charge your 24 VDC trolling motor battery from the 12 VDC alternator on your main engine or trailer hook-up.
- For installations with 12 VDC alternator to 100 A
- A single output 12 VDC charger will charge all batteries
- Withstands ambient temperature to over 175°F
- Simple 5 wire installation with all cables for basic hookup
- Fully automatic, waterproof and operates while submerged in salt water



Item	Model	Ship	Net
200082	TB24	2 lbs	\$78.99

### XANTREX LINKLITE/LINKPRO BATTERY MONITORS

- Displays voltage, current, consumed amp hours and remaining battery capacity
- Secondary battery bank voltage monitoring
- Large backlit LCD display
- Programmable alarm relay
- Splash-proof front panel
- 500 A shunt included
- Supply voltage range: 9-35 VDC



LinkLite

LinkPro

#### LinkPRO Features: (In addition to LinkLite features)

- Displays battery time remaining
- Stores history in memory
- Battery temp sensor input
- Communication/expansion port
- Advanced programmable alarm relay

Item	Model	Description	Voltage Range	Maximum Current	Ship	Net
204689	84-2030-00	LinkLite	9-35 VDC	1000 A	1 lbs	\$227.99
204690	84-2031-00	LinkPro	9-35 VDC	10,000 A	1 lbs	264.99

### BLUE SEA SYSTEMS AUTOMATIC CHARGING RELAY (STARTING ISOLATION)

- 12/24 VDC auto ranging voltage input
- Ignition protected • Up to 120 A
- Isolates house loads when starting engine

Item	Model	Ship	Net
204621	7610	2 lbs	\$88.99



### BLUE SEA SYSTEMS ML-SERIES AUTOMATIC CHARGING RELAY

- Automatically manages charging of (2) large battery banks
- Continuous amperage: 500 A
- Includes remote control switch (On)-Off-(On); manual override option

Item	Model	Voltage	Ship	Net
201833	7622	12 VDC	2 lbs	\$192.99
	7623	24 VDC	2 lbs	192.99



### BLUE SEA SYSTEMS M-ACR MINI AUTOMATIC CHARGING RELAY

- Combines batteries during charging; isolates batteries when discharging
- Dual sensing – senses charging on either battery bank
- Voltage: 12 / 24 VDC • Amperage: 65 A continuous

Item	Model	Ship	Net
204926	7601	1 lbs	\$61.99



### BLUE SEA SYSTEMS ML-ACR AUTOMATIC CHARGING RELAY

- Automatically manages the charging of (2) battery banks
- Amperage: 500 A continuous
- Includes ML-Series remote control switch

Item	Model	VDC	Ship	Net
201834	7620	12	2 lbs	\$184.99
	7621	24	2 lbs	184.99



### MAGNUM ME-SBC SMART BATTERY COMBINER

The ME-SBC is an innovative, easy-to-use, stand alone, two-bank battery combiner and isolator for 12 and 24 VDC systems. Designed to monitor and charge a second battery using a portion of the current that is charging a main battery, this 25 A combiner/isolator integrates:

- Solenoid drive for requirements greater than 25 A
- A remote voltage sense for more accurate sensing
- High and low battery cut-out to prevent over / undercharging
- Voltage auto-detect feature recognizing 12 or 24 VDC
- Wide range of adjustable voltage setting allows for (maximum) charging flexibility
- Including automatic on and off set points, the ME-SBC prevents under or over-charging
- Bi-directional charging
- Reverse polarity protection
- Sense lead for long-run applications

Item	Model	Ship	Net
259019	ME-SBC	1 lbs	\$139.99



❖ For more detailed product specifications and our complete selection visit [www.defender.com](http://www.defender.com) or call 800-628-8225. ❖





## Shore Power has a New Leader.

Designed for ultimate performance in harsh environments, all Furriion products meet rigorous, global industry standards including ABYC, CE, USCG and Marine UL listed. Built for safety, Furriion products feature PowerSmart™ and Faultsmart™ technology to inform the boater of normal or abnormal conditions. We invite you to enjoy the quality, performance and value of Furriion products on your boat. Furriion stands behind its products with a 5-year warranty.



### CORDSETS

Pic	Item	Model	Description	Color	Ship	Net
	202345	FP15EX-SY	15A 50' cordset	Yellow	6 lbs	\$38.99
A	201933	F30C25-SY	30A 25' cordset	Yellow	8 lbs	69.99
		F30C25-SS	30A 25' cordset	Titanium	8 lbs	72.99
B	201934	F30C50-SY	30A 50' cordset	Yellow	15 lbs	74.99
		F30C50-SS	30A 50' cordset	Titanium	15 lbs	82.99
C	201615	F30C12-SY	30A 12' cordset w/ LEDs	Yellow	5 lbs	44.99
D	201935	F30P25-SY	30A 25' cordset w/ LEDs	Yellow	9 lbs	69.99
		F30P25-SS	30A 25' cordset w/ LEDs	Titanium	9 lbs	72.99
E	201936	F30P50-SY	30A 50' cordset w/ LEDs	Yellow	15 lbs	79.99
		F30P50-SS	30A 50' cordset w/ LEDs	Titanium	15 lbs	82.99
F	201616	F50125-SY	50A/125 V 25' cordset with bag and Velcro strap	Yellow	22 lbs	349.99
F	201617	F50150-SY	50A/125 V 50' cordset with bag and Velcro strap	Yellow	38 lbs	389.99
-	201618	F50225-SY	25' 125/250 V cordset with bag and Velcro strap	Yellow	25 lbs	389.99
-	202385	F50250-SY	50' 125V/250 V cordset	Yellow	41 lbs	519.99
		F50250-SW	with bag and Velcro strap or White			

### Y-ADAPTERS

Pic	Item	Model	Description	Color	Ship	Net
G	201630	F1530Y-SY	(2) 15A (F) straight blade to 30A (M)	Yellow	4 lbs	\$97.99
H	201631	F3030Y-SY	(2) 30A (F) to 30A (M)	Yellow	4 lbs	162.99
I	201632	F3050Y-SY	(2) 30A (F) to 50A 125 V (M)	Yellow	8 lbs	225.99
J	201633	F3052Y-SY	(2) 30A (F) to 50A 125/250 V (M)	Yellow	8 lbs	194.99
-	201635	F5052Y-SY	(2) 50A 125V (F) to 50A 125/250V (M)	Yellow	11 lbs	399.99

### PIGTAIL ADAPTERS

Pic	Item	Model	Description	Color	Ship	Net
K	201620	FP1530-SY	15A (F) to 30A (M)	Yellow	2 lbs	\$50.99
-	201628	FP1530-SS	15A (F) to 30A (M)	Titanium	2 lbs	39.99
L	201621	FP3015-SY	30A (F) to 15A (M)	Yellow	2 lbs	46.99
M	201622	FP3050-SY	30A (F) to 50A 125 V (M)	Yellow	4 lbs	112.99
-	201623	FP3055-SY	30A (F) to 50A 125/250 V (M)	Yellow	4 lbs	117.99
N	201624	FP5030-SY	50A 125 V (F) to 30A (M)	Yellow	4 lbs	134.99
-	201625	FP5055-SY	50A 125 V (F)-125/250 V (M)	Yellow	5 lbs	159.99
-	201626	FP5530-SY	50A 125/250 V (F) - 30A (M)	Yellow	4 lbs	152.99
O	201627	FP5550-SY	50A 125/250V (F)-50A 125 V (M)	Yellow	4 lbs	219.99

### STRAIGHT ADAPTERS

Pic	Item	Model	Description	Color	Ship	Net
P	201651	F1530AD-SS	15A (M) to 30A (F)	Yellow	1 lbs	\$37.99
Q	201654	F3015AD-SS	30A (M) to 15/20A (F)	Yellow	1 lbs	34.99

### 15 AMP ACCESSORIES

Pic	Item	Model	Description	Color	Ship	Net
R	201655	F15FMP-SY	15/20A Female connector	Yellow	1 lbs	\$26.99
S	201656	F15MLP-SY	15A/125V Straight male plug	Yellow	1 lbs	28.99

### 30 AMP ACCESSORIES & INLETS

Pic	Item	Model	Description	Color	Ship	Net
T	201665	F30COV-SY	Male cover	Yellow	1 lbs	\$11.49
U	201666	F30CVL-SY	Female cover	Yellow	1 lbs	17.99
V	201669	F30RNG-SS	Replacement ring	Gray	1 lbs	6.99
W	201670	F30SLC-SS	Seal collar system	Black	1 lbs	11.99
X	201659	F30FMP-SY	Female connector	Yellow	1 lbs	29.99
Y	201660	F30MLP-SY	Male plug	Yellow	1 lbs	17.99
Z	202382	F30ITR-PS	Inlet round	White/SS plate	1 lbs	54.99
AA	202379	F30ITS-PS	Inlet square	White/SS plate	1 lbs	54.99
-	202380	F30ITS-SS	Inlet round	Stainless steel	2 lbs	82.99

### 50 AMP ACCESSORIES & INLETS

Pic	Item	Model	Description	Color	Ship	Net
BB	201667	F50COV-SY	Male cover	Yellow	1 lbs	\$19.99
CC	201668	F50CVL-SY	Female cover	Yellow w/metal ring	1 lbs	28.99
DD	201644	F50INR-PS	125 V Inlet - round	White/SS plate	1 lbs	85.99
-	201648	F50INS-SS	125 V Inlet - round	Stainless steel	2 lbs	143.99
EE	201645	F50INS-PS	125 V Inlet - square	White/SS plate	1 lbs	85.99
-	201649	F52INS-SS	125/250 V Inlet - round	Stainless steel	2 lbs	155.99
-	201647	F52INS-PS	125/250 V Inlet - square	White/SS plate	1 lbs	73.99
FF	201661	F50FMP-SS	125 V Female connector	Black	1 lbs	83.99
GG	201662	F50MLP-SS	125 V Male plug	Black	1 lbs	72.99
-	201663	F52FMP-SS	125/250 V Female connect	Black	1 lbs	82.99
-	201664	F52MLP-SS	125/250 V Male plug	Black	1 lbs	73.99
HH	201671	F50SLC-SS	Seal collar	Black w/metal ring	1 lbs	12.99

### TV CABLE

Pic	Item	Model	Description	Color	Ship	Net
II	201638	FTVC50-SY	50' TV cable	Yellow	2 lbs	\$59.99

### 12 VDC CONNECTIONS

Pic	Item	Model	Description	Color	Ship	Net
JJ	201672	F12VR	12 VDC receptacle	Black	1 lbs	\$9.99
KK	201673	F12PTR++	12 VDC triple adapter	Black	1 lbs	9.99
LL	202495	F12VRSB	12 V Dual USB & 12 V receptacle	Black	1 lbs	19.99
MM	202496	F12SB	12 VDC Dual USB charger receptacle	Black	1 lbs	18.99

++ With Powersmart LED light

# MARLNCO®

**One Hand + A simple twist = Full Power**

The EEL (Easily Engaged Lock) ShorePower cordset has a patented, jaw-clamp design providing one-handed operation and a secure waterproof seal which completely eliminates the need for a locking ring. The EEL connection is built for the harshest environments and is UL approved.



CS504-50



P30-15



P504-30



Y503-2-30



6153SPP



S15-30

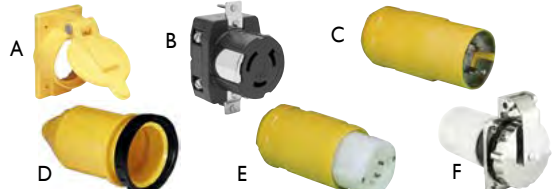
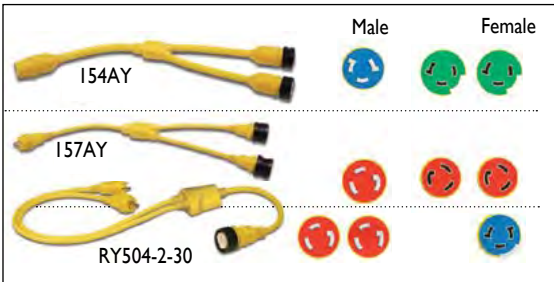

## Shore Power Devices & Accessories

50A • 125 VAC • 2 POLE, 3 WIRE						
Pic	Item	Model	Description	Color	Ship	Net
A	203287	7788CR	Dockside cover with lid	Yellow	1 lbs	\$56.99
B	203291	6370CR	Dockside receptacle	Black	1 lbs	124.99
C	203289	6361CRN	Male plug	Yellow	1 lbs	89.99
D	203284	7715CRN	Boatside cover with sealing collar	Yellow	1 lbs	31.99
E	203283	6360CRN	125 VAC female connector	Yellow	1 lbs	99.99
F	203282	6371EL	125 VAC inlet	SS	2 lbs	169.99

## Shore Power Accessories

Item	Model	Description	Ship	Net
<b>30A 125 VAC CORDSETS</b>				
204886	CS30-25	30A 25' EEL Cordset	10 lbs	\$102.99
204887	CS30-50W	30A 50' EEL Cordset - White	16 lbs	119.99
204887	CS30-50	30A 50' EEL Cordset - Yellow	16 lbs	116.99
<b>50A 125 VAC CORDSETS</b>				
204888	CS503-25	50A 25' EEL Cordset	21 lbs	\$479.99
204889	CS503-50	50A 50' EEL Cordset	37 lbs	525.99
<b>50A 125/250 VAC CORDSETS</b>				
204890	CS504-25	50A 25' EEL Cordset	25 lbs	\$519.99
204891	CS504-50	50A 50' EEL Cordset	47 lbs	735.99
<b>Y ADAPTERS</b>				
204904	Y30-2-30	30A Male to (2) 30A females	6 lbs	\$207.99
204905	Y503-2-30	50A 125 VAC male to (2) 30A females	7 lbs	267.99
204906	Y504-2-30	50A 125/250 VAC male to (2) 30A females	7 lbs	232.99
204907	Y504-2-503	50A 125/250 VAC male to (2) 50A 125V females	8 lbs	489.99
<b>PIGTAIL ADAPTERS</b>				
204893	P15-30	15A male (straight) to 30A female (locking)	2 lbs	\$61.99
204894	P30-15	30A male (locking) to 15A female (straight)	2 lbs	68.99
204895	P30-503	30A male (locking) to 50A/125 VAC female (locking)	3 lbs	184.99
204896	P30-504	30A male (locking) to 50A 125/250 VAC female (locking)	3 lbs	199.99
204898	P504-30	50A 125/250 VAC male (locking) to 30A female (locking)	4 lbs	169.99

For Sealink 12 VDC receptacles and cords please visit [www.defender.com](http://www.defender.com)

## Traditional - (Non-EEL) Cordsets and Adapters

30A 125 VAC POWER CORD PLUS CORDSETS				
204104	199116	30A 12' with LED ergo grip	5 lbs	\$54.99
202404	199117	30A 25' with LED ergo grip, select color Gray or Yellow	7 lbs	88.99
	199119	30A 50' with LED ergo grip, select color Gray or Yellow	14 lbs	97.99
50A 125 VAC CORDSETS				
204335	6153SPP	50A 50' Power cord plus - Yellow	36 lbs	\$459.99
204075	6153SPPW	50A 50' Power cord plus - White	36 lbs	499.99
50A 125/250 VAC CORDSETS				
202405	6152SPPG-25	50A 25' Power cord plus - Gray	23 lbs	\$477.99
	6152SPP-25	50A 25' Power cord plus - Yellow	23 lbs	469.99
	6152SPPW-25	50A 25' Power cord plus - White	23 lbs	507.99
	6152SPPG	50A 50' Power cord plus - Gray	45 lbs	649.99
	6152SPP	50A 50' Power cord plus - Yellow	45 lbs	639.99
	6152SPPW	50A 50' Power cord plus - White	45 lbs	659.99

**Y-ADAPTERS - Color: Yellow. 5 year warranty.**

Equipped with covers and sealing collars approved for use in wet locations. **Female Connector** is locking with sealing collar. **Male Plug** is locking.

Item	Model	DOCK SIDE		Ship	Net
		Attaches to dockside receptacle or cordset	Attaches to cordset or boat inlet		
203361	I54AY	50A 125/250 VAC	2-50A 125 VAC	8 lbs	\$429.99
203362	I57AY	30A 125 VAC	2-30A 125 VAC	5 lbs	182.99
201879	RY504-2-30	2-30A 125 VAC	50A 125/250 VAC	8 lbs	377.99

STRAIGHT ADAPTERS					
204900	S15-30	15A straight male to 30A locking female	1 lbs	\$43.99	
204901	S20-15	20A locking male to 15/20A straight female	1 lbs	49.99	
204903	S30-15	30A locking male to 15/20A straight female	1 lbs	43.99	

**PIGTAIL ADAPTERS - Color: Yellow. 5 year warranty.**

Equipped with covers and sealing collars (where indicated) and are for use in wet locations.

Item	Model	DOCK SIDE		Ship	Net
		Attaches to Dockside Receptacle or Cordset	Attaches to Cordset or Boat Inlet		
201857	I04SPP	15A 125 VAC, Straight blade w/locking screw	30A 125 VAC, Locking with collar LED indicator light	2 lbs	\$55.99
201856	I05SPP	30A 125 VAC locking	15A 125 VAC, with LED indicator light straight blade	2 lbs	58.99
203354	I110A	50A 125 VAC locking	30A 125 VAC, Locking with sealing collar	3 lbs	125.99
203355	I111A	30A 125 VAC locking	50A 125 VAC, Locking with sealing collar	3 lbs	157.99
201036	I21A	50A 125/250 VAC locking	30A 125 VAC, Locking with sealing collar	3 lbs	127.99
203508	I99128	30A 125 VAC	(3) 15A 125VAC, GFCI	3 lbs	104.99
202403	I50SPP	15A 125 VAC	50A 125/250 VAC with sealing collar	2 lbs	71.99



50A • 125/250 VAC • 3 POLE, 4 WIRE						
Pic	Item	Model	Description	Color	Ship	Net
A	203287	7788CR	Dockside cover with lid	Yellow	1 lbs	\$56.99
B	203294	6369CR	Dockside receptacle	Black	1 lbs	125.99
C	203292	6365CRN	Locking male plug	Yellow	1 lbs	90.99
D	203288	7717N	Dockside cover	Yellow	1 lbs	24.99
E	203284	7715CRN	Weatherproof cover with threaded sealing ring	Yellow	1 lbs	31.99
F	203286	6364CRN	125/250 VAC female connector	Yellow	1 lbs	98.99
G	203285	6373EL	125/250 VAC male power inlet	Stainless	2 lbs	177.99

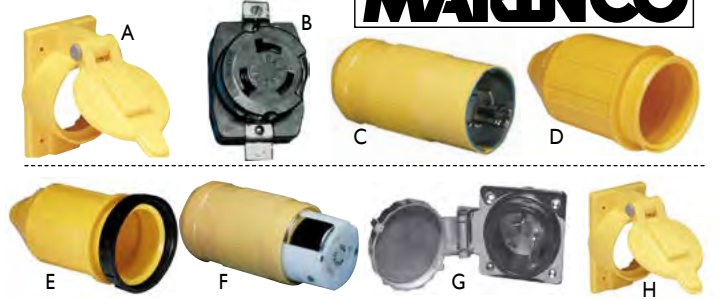

30A • 125 VAC • 2 POLE, 3 WIRE						
Pic	Item	Model	Description	Color	Ship	Net
H	203280	7420CR	Cover with lid	Yellow	1 lbs	\$45.99
I	203281	305CRR	Locking receptacle	Yellow	1 lbs	37.99
J	203279	305CRPN	Male plug	Yellow	1 lbs	20.99
K	203515	305CRMB	Replacement interior inlet plug	Black	1 lbs	28.99
L	203278	102N	Dockside cover	Yellow	1 lbs	14.99
M	203277	103RN	Boatside cover w/ring	Yellow	1 lbs	20.99
N	203276	305CRCN	Female connector	Yellow	1 lbs	35.99
O	203275	303SSEL-B	Boatside inlet	Stainless	2 lbs	92.99
P	203274	301EL-B	Boatside inlet	White Poly	1 lbs	60.99
Q	201028	305CRPN.VPK	Male plug replacement kit	Yellow	1 lbs	34.99
R	201027	305CRCN.VPK	Female plug replacement kit	Yellow	1 lbs	57.99

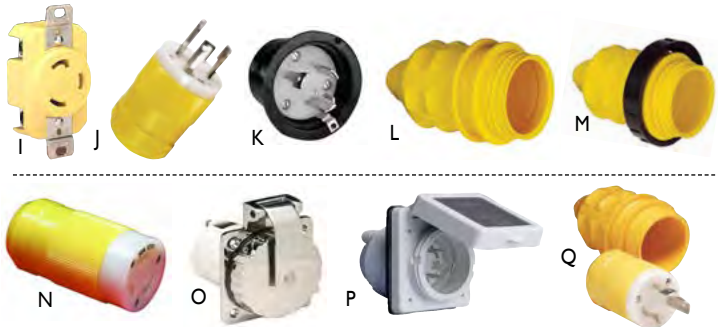

CORD COVER FOR 50A OR 30A CORDSETS						
Pic	Item	Model	Description	Color	Ship	Net
S	204836	CCVR-24	24' Fabric cord set cover	Black	2 lbs	\$55.99



PHONE AND CABLE TV						
Pic	Item	Model	Description	Color	Ship	Net
T	203296	PH6592TV-SS	Phone/TV inlet	Stainless	2 lbs	\$129.99
U	203295	PH6574TV	Phone/TV inlet	White Poly	1 lbs	97.99



ADAPTERS, ACCESSORIES AND REPLACEMENT KITS						
Pic	Item	Model	Description	Color	Ship	Net
V	000170	CH-I	Windline shore power cable holder, 2-1/2" eye, 28" high		2 lbs	\$51.99
W	204655	IRPC	Marinco 30 amp right angle cordset adapter		3 lbs	46.99

**SMARTPLUG**  
Innovations in Power Delivery

50A/50' MARINE CORD

**SUPERFLEX50**

EASY TO ROLL UP IN COLD & WARM WEATHER!  
SUPERFLEX50 - Rated for -58 degrees F to +220 degrees F. The TPE jacket along with stranded bare copper conductors, makes SUPERFLEX50 the best combination of flexibility & durability.

- Tinned #6 Wire
- Stows easily & remains flexible
- Standard Dockside Connector
- Coils tightly even in freezing weather!

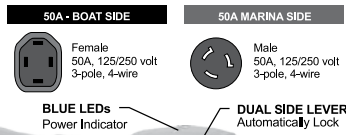

C50504 - 50' / 50A Four Wire

30A/50' MARINE CORDS/INLETS



C30503BM30NT

C30503BM30PW

**SAFE**

INCREASED PIN CONTACT AREA  
WEATHERPROOF - TRIPLE SEALS

**SIMPLE**

INSTALLS IN MINUTES  
EASY TO USE

**SECURE**

SLEEVED DESIGN  
MULTI-POINT LOCKING SYSTEM

30A - INLETS / PLUGS / CORDS

Item	Model	Description	Color	Ship	Net
202386	BM30NT	30A boatside inlet with cover	Stainless	2 lbs	\$139.99
	BM30PW	30A boatside inlet with cover	White	1 lbs	109.99
201904	BF30	Boatside connector 30A/125V	Orange	1 lbs	72.99
202387	B30ASSYNT	30A inlet and connector kit	Stainless	3 lbs	204.99
	B30ASSYPW	30A inlet and connector kit	White	2 lbs	172.99
202388	C30253 25'	30A dual config. 25' cordset	Orange	8 lbs	184.99
	C30503 50'	30A dual config. 50' cordset	Orange	16 lbs	229.99
202389	C30503BM30NT	50' cord with 30A inlet	Stainless	16 lbs	364.99
	C30503BM30PW	50' cord with 30A inlet	White	16 lbs	335.99

50A - INLETS / PLUGS / CORDS

Item	Model	Description	Color	Ship	Net
202390	BM50S	50A boatside inlet/cover, 125/250V	Stainless	2 lbs	\$197.99
	BM50PW	50A boatside inlet/cover, 125/250V	White	1 lbs	149.99
202047	BF50	50A boatside connector, 125/250V	Orange	2 lbs	99.99
202391	B50ASSY	50A inlet/connector kit, 125/250V	Stainless	3 lbs	284.99
	B50ASSYPW	50A inlet/connector kit, 125/250V	Orange	2 lbs	244.99
202500	C50254	50A dual config. 25' cordset	Orange	20 lbs	479.99
	C50504	50A dual config. 50' cordset	Orange	41 lbs	549.99

ELCI - SENSORS & BREAKERS

Item	Model	Description	Ship	Net
202522	ELCISENSORSS	30A/50A Electrical leakage sensor - Stainless	2 lbs	\$349.99
	ELCISENSORNMW	30A/50A Electrical leakage sensor - White	1 lbs	319.99
202523	ELCI30BRKERSS	30 Amp breaker - Stainless mounting bracket	2 lbs	299.99
	ELCI30BRKERNMW	30 Amp breaker - White mounting bracket	1 lbs	269.99
	ELCI50BRKERSS	50 Amp breaker - Stainless mounting bracket	2 lbs	349.99
	ELCI50BRKERNMW	50 Amp breaker - White mounting bracket	1 lbs	319.99

Accessories

Item	Model	Description	Ship	Net
201908	A1001	Smartplug weatherproof cover	1 lbs	\$20.99
202394	CB001	Cordset carry bag, Fits 25' - 75' cords	1 lbs	19.99

## Galvanic Isolators/Conditioners

### ProMariner Prosafe FS Series Galvanic Isolators

- Installs easily and does not require a dedicated monitor to verify the operational status as required by non FailSafe Certified galvanic isolators
- FlatPack semiconductor platforms ensure that in the event of a failure, the failure is safe
- ABYC A-28 compliant and Fail Safe Certified
- Ignition protected - meets ISO 8846
- Gold plated terminations
- Max temp.: 122° F / 50° C



22034

Model	Shore Cord Inlet Compatibility	Volt AC / Max AMPS / Hz
22034	15, 16, 20 or 30A	120/240 Volt AC / 41 A / 50 or 60 Hz
22074	Single 50A or dual 15, 16, 20 or 30A	120/240 Volt AC / 82 A / 50 or 60 Hz

Item	Model	Description	Dimensions	Ship	M.A.P.
258147	22034	30 A galvanic isolator	6.75" x 7" x 2.5"	4 lbs	\$318.99
258148	22074	60 A galvanic isolator	7.25" x 6.5" x 3.75"	5 lbs	425.99

## Transformers

### Charles Marine ISO-G2 Isolation Transformer

- Value priced; isolates the boat from potential shore-side power hazards
- Designed to be a viable alternative to using a galvanic isolator with status monitor, as is now required by ABYC. The ISO-G2 offers all of the benefits and features of an isolation transformer:
- Onboard protection of AC electrical/electronic products from shore
- Elimination of the need for galvanic isolators and polarity alarms
- Easy to install, compact and provides a valuable onboard solution
- Full-current carrying shield between the primary/secondary windings of the transformer
- Includes terminal blocks
- Manufacturer's one year limited warranty
- Made in the USA
- Measures 9.65" x 10.5" x 9"



Item	Model	Description	Ship	Net
255946	93-ISOG2/6-A	3.6KVA, 30 A, 120 Volt AC, 60Hz	71 lbs	\$639.99
256069	93-ISOG2/8-A	3.8KVA, 30/32 A, 120/240 VAC, 50/60Hz	71 lbs	679.99

### Charles Marine 12 kVA International Universal IsoTransformer

- Completely isolates AC shore power from boat's AC electrical system
- Prevents galvanic current corrosion due to direct connection to AC shore power
- Output: 50 Amps max., 120/240 VAC or 104/208 VAC
- Kilovolt amps: 12kVA
- Input: 50 amps 120/240 VAC; Frequency: 50 / 60 Hz
- Marine UL listed, meets all ABYC and USCG requirements
- Designed and manufactured in USA



Item	Model	H x W x D	Ship	Net
204093	93-IXFMR12I-A	12" x 15" x 16"	259 lbs	\$2169.99

## Grounding Plates

### Grounding Plates

- Deters electrolysis and galvanic corrosion. Used for basic bonding and grounding.
- Sintered porous bronze sphere construction for maximum conductivity in a compact size
- Low drag, non-fouling shape
- Provides a direct, low resistance path for improved lightning protection
- Offers the best path for hull bonding without long runs of copper foil
- Improves performance of electronics and reduces RF interference



Item	Model	Dimensions	Protection	Ship	Net
252162	4006 Standard	6" x 2" x 1/2"	12 sq. ft.	2 lbs	\$97.99
252163	4008 Large	8" x 2-1/2" x 1/2"	20 sq. ft.	3 lbs	164.99
252164	4012 Giant	12" x 3" x 1/2"	40 sq. ft.	4 lbs	257.99
252165	4018 Super	18" x 6" x 1/2"	100 sq. ft.	12 lbs	559.99

For maximum protection and support of SSB, use 4018 Super.

### Yandina Waterproof Galvanic Isolator

1 Year Warranty!

Blocks electrolysis currents from flowing in the ground conductor of your shore power hookup.

- Provides approximately 1.2 or 2.4 volts to isolate electrolytic voltages from the dock and safely pass currents to ground in the event of a short circuit or power leakage on your boat



Item	Model	Description	Size	Volts	Ship	Net
204577	GI-50N	50A, 115/230 Volt AC	4" x 3" x 1.5"	1.2	1 lbs	\$82.99
202474	GI+	50A, 115/230 Volt AC	5.5" x 3" x 1.5"	2.4	2 lbs	\$169.99

### Newmar Galvanic Isolators

- Internal components and heat sinks are sized to comply with the new standards
- Large capacitor provides a secondary low impedance path for stray AC current
- Improved galvanic protection



GI-30

Item	Model	Description	Frequency Rating	Ship	Net
203544	GI-30	30 A, 115/230 Volt AC	50 / 60Hz	3 lbs	\$199.99
203545	GI-50	50 A, 115/230 Volt AC	50 / 60Hz	5 lbs	235.99

## Portable Battery Chargers

### Blue Sea Systems BatteryLink® Chargers



Item 202351	10A	Net \$175.99
Item 205045	20A	274.99

Total Output Current	10A	20A
Nominal Voltage	12V DC	
Number of Outputs	1 negative / 2 positive	
Terminal Stud Torque	60 in-lb	
Continuous Rating	65A	170A
Intermittent Rating	115A	-
Universal AC Input Voltage	90-265V AC	
AC Input Frequency	50/60Hz	
Typical Float Voltage	13.5V DC	
Battery Types	AGM / Flooded / TPPL	
Cable Size to Meet Ratings	10 AWG Negative Cable / 6 AWG Positive Cable	
Maximum Battery CCA	850CCA	
Maximum Cable Size	1/0 AWG (50mm)	
Operating Current	10mA / 60mA	
Recommended Battery Bank Sizes	120Ah Maximum 60Ah Minimum	60Ah Minimum
Terminal Stud Size	1/4"-20	

### NOCO Genius Series Battery Chargers

- 6V and 12V battery charger and maintainer
- Charges lead-acid and lithium-ion batteries
- Recovers deeply discharged batteries down to 2-volts
- Spark-proof technology and reverse polarity protection
- Built-in battery desulfator recovers worn-out batteries
- Safely monitors battery actively with zero overcharge
- Suitable for start-stop and CANbus vehicle systems
- Advanced diagnostics indication for damaged batteries



Item	Model	(Amp Hours) Input	VAC	Charging	Consumption	Ship	Net
202506	G1100	Up to 40	85-130	1.1 Amps	30 Watts	2 lbs	\$42.99
202507	G3500	Up to 120	85-130	3.5 Amps	60 Watts	3 lbs	59.99

- 12 Volt and 24 Volt automatic battery charger and maintainer
- Progressive repair mode for heavily sulfated 12 Volt batteries
- Jumpcharge engine starting for dead batteries.

Item	Model	(Amp Hours) Input	VAC	Charging	Consumption	Ship	Net
202508	G15000	Up to 400	110-120	15 Amps	255 Watts	7 lbs	\$159.95
202509	G26000	Up to 500	110-120	26 Amps	443 Watts	8 lbs	199.95

## Test Meter

### ProMariner Corrosion Test Meter

- Portable analog corrosion test meter
- Ideal for saltwater testing
- 20' Lead
- Scale is simple to read - Green (good), Yellow (bad)
- Meter uses: Corrosion survey, zinc saver testing and bonding continuity test (out of water)



Item	Model	Ship	Net
200596	20006	2 lbs	\$267.99



Some manufacturers set M.A.P. (Minimum Advertised Pricing) for their products, so we cannot advertise a lower price. However, this does not always apply to selling price. The actual price you will be charged is probably lower. Please call us at 800-628-8225 for further details.





# ProMariner



## ProMariner ProNauticP Series Digital Charging Systems

Global AC Input 100-260 VAC 50/60 Hz

- ProMar digital performance - 12 selectable charge profiles
- Power factor corrected
- Conservation energy saver mode
- Dual digital displays with power output bar
- On board, self-test start up diagnostics
- Automatic battery health mode and fan speed control
- LED illuminated service and fault modes for ease of use and trouble shooting
- Built-in safety with automatic temperature compensation



Item	Model	Mfg Model	VDC	Amps	Banks	Ship	M.A.P.
201846	63110	I210P	12	10	2	6 lbs	\$219.99
201847	63115	I215P	12	15	3	6 lbs	Net 269.99
201848	63120	I220P	12	20	3	6 lbs	339.99
201849	63130	I230P	12	30	3	7 lbs	Net 409.99
201850	63140	I240P	12	40	3	7 lbs	439.99
201851	63150	I250P	12	50	3	8 lbs	569.99
201852	63160	I260P	12	60	3	9 lbs	699.99
201853	63170	I2420P	24	20	3	7 lbs	449.99
201854	63180	I2430P	24	30	3	9 lbs	699.99
201953	63100	Digital display and remote control				1 lbs	Net 89.99

## ProSport Gen 3 Series Battery Chargers



- ProMar digital technology
- Automatic energy saver mode
- System OK and battery bank trouble status indicators
- Digital multi-stage performance charging
- Storage recondition mode
- Distributed-On-Demand technology
- Digital LED display and battery type selector
- Built-in quality and safety
- Pre-wired for easy installation
- AC input: 90-135 VAC / 60 Hz
- 2 year warranty

Item	Model	Volts	Amps	Banks	Ship	Net
204947	43006 ProSport6	12	6	1	5 lbs	\$99.99
204948	43008 ProSport8	12/24	8	2	5 lbs	128.99
204949	43012 ProSport12	12/24	12	2	6 lbs	149.99
204950	43020 ProSport20*	12/24	20	2	8 lbs	179.99
204951	43021 ProSport20 Plus	12/24/36	20	3	8 lbs	187.99

\* Includes a HP AGM charge profile



## The Sterling Power ProAlt C Alternator to Battery Charger

Effective, simple and installs quickly; it transforms the output of your alternator into a sophisticated multi-stage battery charger resulting in faster and more complete charging of your battery bank(s). The ProAlt C is fitted between the alternator and the battery, and, unlike conventional alternator boosters, requires no modification / interference with the alternator whatsoever - therefore, bypassing any ECU or warranty restrictions. The ProAlt C optimizes the available output of the alternator and converts the output to mimic that of a mains driven 4 stage

battery charger. Consequently, your batteries will charge 5 times faster - this means less fuel used. The ProAlt C can, therefore, pay for itself in a matter of weeks.

### Features:

- Always ensures start battery is properly charged but also prevents the starting battery from being overcharged and damaged
- Quick and easy installation
- Integral split charge facility
- No alternator modification required
- Multiple alternator input possible
- Installs in place of a standard alternator to battery isolator
- Battery and alternator temperature sensing
- Battery type selectable
- Typically 5 times faster and 100% more charge
- Start battery fail safe
- Input: alternator
- Output: 12 VDC, 130 A or 210 A

Item	Model	Input	Output VDC	Max Alt Amps	L x W x H	Ship	Net
259313	AB12130	Alternator	12	130	10.63" x 7.1" x 3.14"	6 lbs	\$379.10
259314	AB12210	Alternator	12	210	9.84" x 11.02" x 2.75"	10 lbs	469.20
259315	ABNRC	Power remote with 10 m of cable for AB12130				1 lbs	112.20
259316	ABRC	Power remote with 10 m of cable for AB12210				3 lbs	215.90

## Xantrex TRUECharge2 Series Battery Chargers



20 A and larger models offer parallel stacking when combined with the remote panel. This allows them to work together to combine and double their output current for large battery banks.

- Lightweight, ultra-compact, universal chargers
- Handles input voltage range from 90-265 VAC, 47-63 Hz so they're compatible with a generator, poor-quality power or foreign travel
- Settings for flooded, gel, AGM or lead-calcium batteries
- Drip-proof design enables the charger to be mounted in multiple directions
- Meets CE/EMC, ABYC, UL 1564 and UL 1236 with marine supplement standards



Visit [defender.com](http://defender.com) for complete features and specifications.

Item	Model	Description	Ship	Net
201875	804-1210	12 VDC, 10 A, 2 banks	4 lbs	\$189.99
204832	804-1220-02	12 VDC, 20 A, 3 banks	7 lbs	279.99
204833	804-1240-02	12 VDC, 40 A, 3 banks	7 lbs	339.99
204844	804-1260-02	12 VDC, 60 A, 3 banks	10 lbs	574.99
204610	808-0232-01	Battery temperature sensor	1 lbs	32.99

### TRUECharge2 REMOTE PANEL

Item	Model	Description	Ship	Net
204834	808-8040-01	TRUECharge2 remote panel (see compatibility above)	2 lbs	\$77.99



## Xantrex Echo-Charge Battery Charger

Designed to charge auxiliary or starting batteries from an inverter/charger or other charging source with limited voltage drop. Detects when the battery bank is being charged and directs a portion of the charge current to auxiliary or starting batteries.

- 15 A maximum charge current
- Automatically adjusts for 12 VDC or 24 VDC battery banks (both battery banks must be the same DC voltage and battery type)
- Automatically switches On/Off without affecting the in-house battery bank or over-charging
- Uses excess current from the primary charging source
- Thermal and over-current circuits
- Reverse polarity protection
- Easy three wire installation
- One year warranty

Item	Model	Dimensions	Ship	Net
204014	82-0123-01	5.5" H x 4.5" W x 1.25" D	2 lbs	\$126.99

## Blue Sea Systems Gen II P12 Series Battery Chargers

The Blue Sea Systems 25 A and 40 A P12 battery chargers are four stage, three output, dry mount devices designed for use in harsh environments where reliability, ease of use and high performance are of primary importance. Designed to charge (3) electrically independent batteries or battery banks, the P12 has the unique capability to individually move each battery out of the absorption charging stage. 5-year warranty.



Item	Model	Amps	Input	Output VDC	Ship	Net
202456	7531	25 A	4.5A @ 115 VAC / 2.25A @ 230 VAC	12	10 lbs	\$499.99
202457	7532	40 A	7.5A @ 115 VAC / 3.75A @ 230 VAC	12	10 lbs	629.99
204958	7520	P12 battery charger LED remote			1 lbs	107.99

## Guest On-Board Battery Chargers

- All high frequency, digital charging technology
- Fully automatic 5-stage performance charging
- Dedicated battery charging, sensing and control per bank
- Expanded LED charge status monitor
- Wiring and battery fault detection
- Auto-maintain energy saver mode
- Up to 40 percent lighter
- 100 percent waterproof (IP67) and shock resistant for all fresh and saltwater applications
- All models are pre-wired for easy installation
- For all 12 VDC flooded and AGM lead acid batteries
- Built-in safety: reverse polarity, over-current, over-voltage, over-temperature and ignition protection. In-line fuses for maximum DC wire protection
- 2 year warranty



Item	Model	Amps	Output	Banks	Input	Frequency	Ship	Net
205069	2708A	5	12 VDC	1	120V	50/60 Hz	4 lbs	\$86.99
205070	2711A	10	12 VDC	2	120V	50/60 Hz	6 lbs	129.99
205071	2713A	15	12 VDC	3	120V	50/60 Hz	8 lbs	157.99
205072	2720A	20	12 VDC	2	120V	50/60 Hz	7 lbs	164.99
205073	2731A	30	12 VDC	3	120V	50/60 Hz	8 lbs	295.99
205074	2740A	40	12 VDC	4	120V	50/60 Hz	9 lbs	365.99

**Inverter/Chargers & Accessories**

**Freedom SW Series New Generation Inverter/Chargers**



Parallel stacking enables the Freedom SW inverter/chargers to double the AC output in inverter mode. Series stacking enables the Freedom SW inverter/charger to generate 120 / 240 Volt AC split phase output (AC source must be split phase, requires stacking cable, model 808-9005).

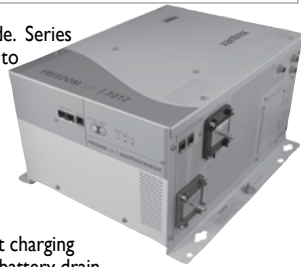

- Integrated, resettable AC breakers
- Built-in transfer switch transfers between inverter power and incoming AC power
- Temperature compensated charging
- Power factor corrected, multi-stage charger for fast charging
- Ignition lockout feature helps prevent unnecessary battery drain
- Wide operating temperature range: -4° to 140°F (-20° to 60°C)
- Dual input / dual output AC interface for 3000 W model
- Ability to charge batteries drained to extremely low voltage
- Compatible with the optional Xantrex Automatic Generator Start (Model 809-0915)
- Both models are approved to UL458, CSA, ABYC and FCC, Class B requirements
- Battery over-voltage and under-voltage protection • Over-temperature shutdown
- Automatic overload protection and short-circuit protection
- Pure sine wave output to operate sensitive electronics

Item	Model	Model/Description	Ship	Net
204846	815-3012	SW 3012, 3000 W inverter, 150A charger	69 lbs	\$1649.99
204845	815-2012	SW 2012, 2000W inverter, 100A charger	52 lbs	1399.99
204866	808-9002	Freedom SW On/Off remote panel	1 lbs	20.99
204847	809-0921	Freedom SW Xanbus remote control panel	1 lbs	194.99
204774	809-0942	75' network cable for system control panel	2 lbs	32.99
204869	808-9005	Stacking cable	1 lbs	10.99
205008	808-9010	Cable adapter for FSW	1 lbs	14.99



**Xantrex Freedom XC Power Inverter / Charger**



**Inverter Features**

- Extended surge rating, 2x continuous power for 2 seconds
- True sine wave AC power
- Ignition control
- Wide 10-18 Volt DC input range
- Programmable AC under-voltage (85-110 Volt AC) shutdown
- Built-in 30 A AC transfer relay

**Charger Features**

- Power factor corrected multi-stage charging
- Programmable for optimal charging of almost any battery type up to 18 Volt
- Battery equalization
- Dead battery charging down to 0 Volt DC
- Power share prioritizes AC loads

Item	Model	Output Inverter/Charger	Input	Ship	Net
205038	817-1050	108 - 120 Volt AC, 1000 W continuous, 50A	12V	17 lbs	\$574.99
	817-2080	108 - 120 Volt AC, 2000 W continuous, 80A	12V	20 lbs	769.99
205039	808-0817-01	Freedom X / XC remote panel		1 lbs	62.99

**Freedom HF Mod Sine Inverters/Chargers**



- One of the smallest and lightest inverters/chargers on the market today
- Temperature controlled multi-stage charging
- Automatic 3-stage 12 Volt DC battery charger
- Integrated transfer switch for automatic change-over between shorepower and inverter
- Temperature compensation with equalization stage provides optimal charging of batteries
- Removable digital display pre-attached with 25' extension cable for remote system monitoring
- Customized settings can be programmed with the Freedom basic remote or link panels
- Over voltage and under voltage protection • Over temperature protection
- Overload protection • Short circuit protection • 24 month warranty

Item	Model	Model	Input Inverter/Charger	Output Inverter/Charger	Ship	Net
204687	806-1020	HF 1000	12/120 Volt DC	1000 W / 20 A	14 lbs	\$429.99
204688	806-1840	HF 1800	12/120 Volt DC	1800 W / 40 A	16 lbs	567.99

Magnum Energy is a leading manufacturer of premium inverter/chargers for mobile and renewable energy applications. With over 150 years of combined inverter design and manufacturing experience, Magnum Energy builds some of the industry's most reliable, advanced and cost effective inverter/chargers and accessories.



**TRUE Sine Wave Inverter/Chargers**

The MS Series inverter/charger is a pure sine wave inverter designed specifically for the most demanding mobile and off grid applications. Powerful, easy-to-use and, best of all, cost effective. Install the MS Series in four easy steps: simply connect the inverter's output to your distribution circuits or electrical panel, connect your shore power cable (AC) to the inverter's easy-to-reach terminal block, connect the batteries and switch on the power.



Item	Model	Description	Ship	M.A.P.
259026	MS2000-20B	2000W, 12 Volt DC, 100A w/1-20A breaker	48 lbs	\$1695.20
259027	MS2012	2000W, 12 Volt DC, 100 A	50 lbs	1735.20
259028	MS2812	2800W, 12 Volt DC, 125 A	63 lbs	1999.20
259029	MS4024	4000W, 18-34 Volt DC, 105 A	63 lbs	2095.20

**MODIFIED Sine Wave Inverter/Chargers**

Inverters designed specifically for rugged recreational vehicle use, the ME Series is powerful, easy-to-use and, best of all, cost effective. The ME series is ETL Listed to the stringent requirements of UL/cUL 458 ensuring that the inverter is safe and reliable. Install the ME series in four easy steps: simply connect the inverter's output to your distribution circuits or electrical panel, connect your shore power cable (AC) to the inverter's easy-to-reach terminal block, connect the batteries and switch on the power.



Item	Model	Description	Ship	Net
259020	ME2012	2000 W, 12 Volt DC, 100 A	44 lbs	\$1149.99
259022	ME3112	3100 W, 12 Volt DC, 160 A	55 lbs	1529.99
259024	MM1212	1200 W, 12 Volt DC, 70 A	23 lbs	769.99

**Magnum Energy 3000 Watt 12 Volt DC Pure Sine Hybrid Inverter Charger MSH Series**

This MSH3012M inverter / charger from Magnum Energy is a 3000 Watt, 12 Volt DC pure sine hybrid inverter charger. The MSH-M Series combines the energy from both AC power or batteries to power loads. This allows the inverter to recharge the batteries when there is surplus power or deliver more power to the loads if they require more than the AC input can supply by itself. Power your TVs, stereos, plasma screens, and other sensitive electronics without worry. The pure sine wave inverter and power factor corrected charger provide clean, reliable inverter power with low total harmonic distortion (THD) of less than 5%. Load support parallels the inverter output with incoming AC sources. Designed with true hybrid technology allowing it to run larger loads from smaller generators.



Item	Model	Description	Ship	M.A.P.
202458	MSH3012M	3000 W 12 Volt DC Pure Sine Hybrid inverter charger MSH series	55 lbs	\$2239.20

**Magnum Battery Monitor Kit**

- Designed for Magnum ME and MS series inverters
- Wired, includes 10' cable
- A "Fuel Gauge" type meter for the battery bank
- Kit includes: Sense module, 50 mv/500 A DC shunt, 5' length, 18 AWG wire, 10' length, 2-conductor, telephone cable



Item	Model	Ship	Net
259017	ME-BMK	2 lbs	\$199.99

**ME-ARC50 Advanced Wired Remote Control**

- For Magnum inverters, auto gen starts and battery monitor kit
- Wired, capable of controlling advanced features via network
- Finger-tip operation, including one-knob programming
- Comes with a 50', 4-conductor (twisted-pair) telephone cable



Item	Model	Ship	Net
259016	ME-ARC50	2 lbs	\$279.99

**ME-RC Remote Control**

- Designed for Magnum inverters, auto gen starts and battery monitor kit
- Wired, includes 50' cable
- Finger-tip operation, including one-knob programming



Item	Model	Ship	Net
259018	ME-RC50	2 lbs	\$209.99



**Inverters**



**Freedom X Power Inverter**

- True sine wave 120 Volt AC inverter with built-in transfer switch
- Full output from -4° F - 104° F for operation in all climate temperatures
- The extended surge rating of the Freedom X makes it ideal to start difficult loads including fridge and microwave
- The quick connect terminals at AC IN/OUT make installation a breeze
- Extended surge rating surges to 2x continuous power for 2 seconds for motor loads
- True sine wave AC power for operation of sensitive and motor loads
- Ignition control feature to turn inverter on/off via a 12 Volt DC signal and to minimize battery drain by switching the inverter off when the ignition key is turned off
- Wide 10-18 Volt DC input range ensures inverter operation on high voltage alternators found on many new vehicle chassis
- Built-in 30 A AC transfer relay senses when outside AC power is present and transfers the load from the inverter to the source of incoming power (shore or generator)
- Huge wiring bay for easy access and quick connect AC in/out terminals



Item	Model	Input	Output	Watts	Ship	Net
205037	817-1000	12 Volt DC	108-120 Volt AC	1000	16 lbs	457.99
	817-2000	12 Volt DC	108-120 Volt AC	2000	19 lbs	629.99
	817-3000	12 Volt DC	108-120 Volt AC	3000	20 lbs	897.99
205039	808-0817-01	Freedom X / XC remote panel			1 lbs	62.99

**2-YEAR MANUFACTURER'S WARRANTY!**



**PROsine Pure Sine Wave Inverters**

The PROsine 1000 and 1800 stand-alone inverters are suited for electrical systems that already have a quality multistage battery charger. For recreational and industrial applications, their 120 Volt DC, 60 Hz AC power output is capable of handling both heavy duty and smaller, multiple AC loads. Safety features include: over-temperature shutdown and automatic overload protection, over-voltage and under-voltage protection, short circuit and AC backfeed protection. Includes transfer switch (hard wire model only) and detachable LCD remote panel.

- 1000 and 1800 W inverters (1500 and 2900 W surge capability)
- True sine wave AC output (crystal controlled)
- Removable LCD display can be mounted remotely for control and monitoring
- Unique DC terminals offer 180-degree connections for easy installation in tight places
- Powersave mode draws only 1.5 W under no load



Item	Model	Description	Input VDC	Output	Watts	Ship	Net
204130	806-1800	w/ GFCI AC outlets	10-16	120 Volt AC	1800	20 lbs	1339.99
204074	806-1802	w/ AC hard wire	10-16	120 Volt AC	1800	20 lbs	1339.99
204129	806-1000	w/ GFCI AC outlets	10-16	120 Volt AC	1000	17 lbs	709.99
204066	808-1800	Remote interface panel for PROsine 1000 and 1800				1 lbs	56.99

**2-YEAR MANUFACTURER'S WARRANTY!**

**Xantrex PRO Series Modified Sine Wave Inverters**

- 1000 / 1800 W inverter easily powers TVs, small appliances and other electronics
- Built-in 15 A circuit breaker on AC pass-through
- Up to 15 A / 20 A pass through for hardwired loads for XM1000 / XM1800 respectively
- Digital remote control displays power output, AC source and battery voltage
- Detachable remote control can be mounted wherever convenient
- Conformal coated electronics provide moisture resistance
- Designed to be hard-wired using a terminal strip or by connecting AC through a GFCI receptacle (included)
- 806-1010 (XM1000) Dimensions: 4.05" H x 8.30" W x 12.95" D
- 806-1810 (XM1800) Dimensions: 4.05" H x 8.30" W x 15.47" D



Item	Model	Power	Input	Output	Ship	Net
200245	806-1010	1000 W	11-15.5 Volt DC	115 Volt AC	10 lbs	349.99
200246	806-1810	1800 W	11-15.5 Volt DC	115 Volt AC	13 lbs	419.99

**2-YEAR MANUFACTURER'S WARRANTY!**



**PROwatt SW Pure Sine Inverters**

- Built-in digital display for Volt DC and output power
- Built-in USB port
- Heavy duty terminals
- Dual GFCI AC receptacles for safe operation
- Available On/Off remote switch (with ignition lockout)
- Meets stringent UL458 regulatory standard
- Two year warranty



Item	Model	Description	Input VDC	Output	Watts	Ship	Net
204823	806-1206	PROwatt SW 600	12	104 - 127 VAC	540	8 lbs	\$199.99
204824	806-1210	PROwatt SW 1000	12	104 - 127 VAC	900	9 lbs	294.99
204825	806-1220	PROwatt SW 2000	12	104 - 127 VAC	1800	13 lbs	439.99
204826	808-9001	PROwatt SW inverter remote panel				1 lbs	20.99

**2-YEAR MANUFACTURER'S WARRANTY!**

**ProMariner**

**Professional Mariner TruePower Plus True Sine Wave Inverters**

- Designed to convert 12 Volt DC battery power to 115 Volt AC
- Will automatically pass through AC inlet power when present
- Innovative dual color digital LCD message center
- Dual color gauges for AC power output and battery DC input
- USB power port
- GFCI convenience outlets
- DC cable covers
- TruePower Plus display functions
- TruePower Plus remote (included)
- Integrated AC cable strain reliefs and front screw connection terminal blocks allow for quick and easy installation without the added need for ring terminals for AC power connections



Item	Model	Description	Input	Output	Watts	Ship	Net
205042	07200	True sine wave	11-15 VDC	115 VAC	2000	9 lbs	\$555.99
205025	07100	Pure/True sine wave	11-15 VDC	115 VAC	1000	10 lbs	429.99

**Professional Mariner TruePower Plus Modified Sine Wave Inverters**

- Designed to convert 12 Volt DC battery power to 115 Volt AC
- Will automatically pass through AC inlet power when present
- Innovative dual color digital LCD message center
- Dual color gauges for AC power output and battery DC input
- USB power port
- GFCI convenience outlets
- DC cable covers
- TruePower Plus display functions
- TruePower Plus remote (included)
- Integrated AC cable strain reliefs and front screw connection terminal blocks allow for quick and easy installation without the added need for ring terminals for AC power connections



Item	Model	Description	Input	Output	Watts	Ship	Net
205023	06120	Modified sine wave	11-15 VDC	115 VAC	1200	9 lbs	289.99
205024	06150	Modified sine wave	11-15 VDC	115 VAC	1500	10 lbs	309.99
205041	06200	Modified sine wave	11-15 VDC	115 VAC	2000	9 lbs	364.99



Some manufacturers set M.A.P. (Minimum Advertised Pricing) for their products, so we cannot advertise a lower price. However, this does not always apply to selling price. The actual price you will be charged is probably lower. Please call us at 800-628-8225 for further details.

❖ For more detailed product specifications and our complete selection visit [www.defender.com](http://www.defender.com) or call 800-628-8225. ❖

ELECTRICAL • Inverters

PHONE 800-628-8225 • FAX 800-654-1616



### INDUSTRIAL PURE SINE WAVE INVERTERS

Premium mobile power in a sleek, lightweight profile. Bring reliable power on the water with the new Go Power! industrial pure sine wave inverter, available in 150-3000 watts. Provide peace of mind when powering electronics with a 2-year warranty.

ITEM	MODEL	OUTPUT (watts)	SURGE	WEIGHT (pounds)	SHIP	NET
202437	GP-ISW700-12	700	1230	6	8 lbs	\$299.99
202438	GP-ISW1000-12	1000	1750	7	9 lbs	347.99
202439	GP-ISW1500-12	1500	2650	9	12 lbs	479.99
202440	GP-ISW2000-12	2000	3500	12	13 lbs	639.99
202441	GP-ISW3000-12	3000	6000	18	20 lbs	959.99



### MODIFIED SINE WAVE INVERTERS

Economical power solutions for running lights, appliances and other resistive loads. The Go Power! modified sine wave inverters range from 225 to 3000 watts and come with a 1-year warranty.

ITEM	MODEL	OUTPUT (watts)	SURGE	OUTLETS	SHIP	PRICE
202485	GP-225HD	225	450	2	1 lbs	Net \$32.99
202486	GP-400HD	400	800	2	2 lbs	Net \$39.99
202487	GP-800HD	800	1600	2	3 lbs	Net \$56.99
202488	GP-1000HD	1000	2000	2	4 lbs	MAP \$111.99
202489	GP-1750HD	1750	3500	2	7 lbs	MAP \$191.99
202490	GP-3000HD	3000	6000	4 (+HW)	11 lbs	MAP \$399.99



### INVERTER CHARGER

3-in-1 system combining an inverter, battery charger and automatic transfer switch to save space and simplify installation. UL listed, the inverter charger is available in 2000 and 3000-watt models and comes with a 3-year warranty.

ITEM	MODEL	WATTS	SURGE	CHARGER	SWITCH	SHIP	M.A.P.
202327	GP-IC-2000-12	2000	3400 (5 sec)	100A	2x50A	46 lbs	\$1231.99
202492	GP-IC-3000-12	3000	4800 (5 sec)	125A	2x50A	50 lbs	1551.99



### GP-ICR-50

Controls the GP-IC-2000 and GP-IC-3000 inverter with the touch of a button.

Item 202328

Ship 2 lbs

M.A.P. \$127.99



### SMART CONVERTER / CHARGERS

Go Power! smart converter/chargers offer fast, accurate charging and help your batteries last longer. 2-year warranty.

ITEM	MODEL	AMPS	SHIP	M.A.P.
202037	GPC-35-MAX	35	7 lbs	\$159.99
202038	GPC-45-MAX	45	7 lbs	167.99
202039	GPC-55-MAX	55	7 lbs	191.99
202040	GPC-75-MAX	75	9 lbs	323.99
202041	GPC-100-MAX	100	9 lbs	355.99



### INVERTER REMOTES

Controls an inverter with the touch of a button.

ITEM	MODEL	USE WITH	SHIP	M.A.P.
202442	GP-ISW-R-12	GP-ISW700, 1000, 1500, 2000, 3000	1 lbs	\$91.99
202067	GP-SWR-A	GP-ISW700, 1000, 1500, 2000, 3000	1 lbs	31.99

## Xantrex Solar Modules



NEW!

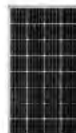

Expansion Kit

### RIGID SOLAR CHARGING KITS

All kits include a 100W or 160W solar panel, 30A PWM charge controller, PV & battery cables and mounting hardware.

Item	Model	Description	Ship	Net
205120	780-0100-01	100W Rigid Solar Charging Kit	20 lbs	\$469.99
205122	780-0160-01	160W Rigid Solar Charging Kit	30 lbs	549.99
205124	781-0100-01	100W Flexible Solar Charging Kit	10 lbs	519.99

### EXPANSION KITS

All expansion kits include a 100W or 160W solar panel, branch connectors and mounting hardware.

Item	Model	Description	Ship	Net
205121	780-0100-02	100W Rigid Expansion Kit	18 lbs	\$329.99
205123	780-0160-02	160W Rigid Expansion Kit	28 lbs	467.99
205125	781-0100-02	100W Flexible Expansion Kit	8 lbs	407.99



NEW!

### SOLAR MAX LIGHTWEIGHT PEEL & STICK FLEX PANELS

Kits include a solar panel, 30A PWM charge controller, PV & battery cables and mounting hardware.

Item	Model	Description	Ship	Net
205126	784-0080-01	80W Solar Max Flex Kit	11 lbs	\$589.99
205128	784-0165-01	165W Solar Max Flex Kit	90 lbs	884.99
205130	784-0220-01	220W Solar Max Flex Kit	90 lbs	1076.99

### EXPANSION KITS

All expansion kits include a 100W or 160W solar panel, branch connectors and mounting hardware.

Item	Model	Description	Ship	Net
205127	784-0080-02	80W Solar Max Flex Expansion Kit	11 lbs	\$449.99
205129	784-0165-02	165W Solar Max Flex Expansion Kit	90 lbs	755.99
205131	784-0220-02	220W Solar Max Expansion Kit	90 lbs	964.99



# YOUR ONE STOP SHOP FOR MOBILE POWER SYSTEMS



plug & play

## COMPLETE POWER SYSTEMS



These complete systems give you the freedom to use your AC and DC devices anywhere and charge your batteries.

### SOLAR EXTREME

3000 Watt pure sine wave inverter charger with built in 125 Amp battery charger and 50 Amp dual leg transfer switch.

- 570W, 27.9 Amp (3x 190 Watt modules)
- 30 Amp PWM digital controller
- Inverter install kit and remote

Item 261815 Ship 207 lbs M.A.P. **\$3679.99**

### SOLAR ELITE

Take an extra long weekend.

- 380 Watt, 18.6 Amp (2x 190 Watt modules)
- 30 Amp PWM digital controller
- 2000 Watt pure sine wave inverter charger (with built-in 100 Amp battery charger and 50 Amp dual leg transfer switch)
- Inverter install kit and remote

Item 261814 Ship 161 lbs M.A.P. **\$2703.99**

### WEEKENDER

Perfect for the weekend warrior.

- 190 Watt, 9.3 Amp (1x 190 Watt module)
- 30 Amp PWM digital controller
- 1500 Watt industrial pure sine wave inverter
- Prewired 30 Amp transfer switch
- Inverter install kit and remote

Item 261813 Ship 98 lbs M.A.P. **\$1643.99**

### ECO SOLAR SERIES

Compact, roof-mounted kits are ideal for trickle-charging in the off-season or for charging a smaller battery bank. 80 Watt and 20 Watt kits include digital controller and all mounting hardware.



ITEM	MODEL	AMPS	WATTS	SHIP	NET
202291	GP-ECO-10	0.57	10	4 LBS	<b>\$55.99</b>
202292	GP-ECO-20	1.14	20	7 LBS	<b>149.99</b>
202293	GP-ECO-80	4.57	80	18 LBS	<b>351.99</b>

## SOLAR CHARGING KITS

Keep batteries healthy and charged while providing freedom to run lights, water pumps, furnaces and other DC appliances. Power output warranty: 25 years. Expansion kits are also available, and include solar panel, mounting hardware, MC4 branch connectors and solar cable.



### OVERLANDER

- 190 Watt, 9.3 Amp solar module
- Easy-to-install 30 Amp PWM digital controller
- 2 x 25' MC4 cables, 1 Red and 1 Black
- Mounting hardware

Item 261811 Ship 90 lbs M.A.P. **\$703.99**



### RETREAT

- 100 Watt, 5.4 Amp solar module
- Easy-to-install 30 Amp PWM digital controller
- 2 x 25' MC4 cables, 1 Red and 1 Black
- Mounting hardware

Item 202446 Ship 28 lbs M.A.P. **\$511.99**

## SOLAR FLEX™ CHARGING KITS

Conforms to the RV rooftop and eliminates any need for custom mounts. Ships with a digital solar controller and can be mounted with adhesive or screws for a secure install. Expand solar capabilities with an expansion kit.



ITEM	MODEL	AMPS	WATTS	SHIP	M.A.P.
202230	GP-FLEX-30	1.7	30	8 LBS	<b>\$319.99</b>
202435	GP-FLEX-50	2.8	50	8 LBS	<b>399.99</b>
202231	GP-FLEX-100	5.6	100	12 LBS	<b>643.99</b>
D 202232	GP-FLEX-200	11.2	200	37 LBS	<b>1011.99</b>

## EXPANSION KITS

Need to add more power to the OVERLANDER, RETREAT and Solar Flex kits? Expansion kits include solar panel, mounting hardware, MC4 branch connectors, and solar cable.

ITEM	MODEL	WATTS	SHIP	M.A.P.
D 261812	OVERLANDER-E	170	90 LBS	<b>\$611.99</b>
202447	RETREAT-E	100	24 LBS	<b>351.99</b>
202233	GP-FLEX-100E	100	7 LBS	<b>511.99</b>
202436	GP-FLEX-50E	50	5 LBS	<b>271.99</b>

## PORTABLE SOLAR KITS

Perfect as single-use chargers or as an additional power source for any rooftop solar kit. Plug and Play connectivity ensures fast and easy set-up between the panels and the battery. Includes 12' UV cables and a durable carry case.

- 10 Amp digital solar controller
- Battery clamps
- Quick connectors
- Ring terminal connectors
- SAE solar plug adapter
- XLR-style solar plug



10 Amp digital solar controller included

ITEM	MODEL	AMPS	WATTS	SHIP	M.A.P.
202530	GP-PSK-90	4.4	90	28 LBS	<b>\$387.99</b>
202531	GP-PSK-130	6.6	130	38 LBS	<b>543.99</b>

## PORTABLE SOLAR KIT ACCESSORIES

(Sold Separately)

ITEM	MODEL	SHIP	M.A.P.
202448	GP-PSK-X30	5 LBS	<b>\$59.99</b>
202449	GP-PSK-7PIN	1 LBS	Net <b>26.99</b>



## SOLAR CONTROLLERS - PWM

- Regulates current from solar panel to batteries
- Pulse Width Modulated (PWM) charging
- Easy to use, digital display
- Dual bank charging\*
- Inverter on/off control\*
- USB charge port
- 5 year warranty



\*30 amp controller only

ITEM	MODEL	AMPS	SHIP	M.A.P.
202480	GP-PWM-10-FM flush mount	10	1 LBS	<b>\$87.99</b>
202322	GP-PWM-30	30	1 LBS	<b>149.99</b>

## SOLAR CONTROLLERS - MPPT

Regulates and prevents the solar panel from overcharging batteries. Maximum Power Point Tracking (MPPT) charging and 3 battery charging profiles.

- Maximizes power from your solar modules
- Stackable: add an additional controller for 80 Amp
- Easy to read backlit remote display
- 5 year warranty



ITEM	MODEL	SHIP	M.A.P.
202481	GP-MPPT-40 40A MPPT solar controller, 150 Volt DC	3 LBS	<b>\$411.99</b>
202482	GP-MPPT-R digital flush mount control for GP-MPPT-40	1 LBS	NET <b>55.99</b>

ELECTRICAL • Solar Panels & Accessories

PHONE 800-628-8225 • FAX 800-654-1616



**BLUE SEA SYSTEMS COMBINATION CIRCUIT BREAKER PANEL**

- Panel style: traditional metal
- ON-indicating LEDs installed in all circuit positions
- Label backlighting pre-installed
- Includes analog voltmeters 9353 (AC) and 8003 (DC), analog ammeter 8017 (DC) and toggle switch to monitor voltage on up to (3) batteries
- All AC and DC buses installed and fully pre-wired
- Tin-plated copper bus bars provide high conductivity and corrosion resistance



Item	Model	Positions	Color	Dimensions W x H x D	Ship	Net
201709	8084	50 A AC Main + 6 100 A DC Main + 15	Graphite	14.75" x 10" x 3"	9 lbs	\$669.99

NOTE: Breaker panels with blank spaces are A series

**BLUE SEA SYSTEMS AC MAIN CIRCUIT BREAKER PANELS**

- Red reverse polarity indicating LED
- All hot, neutral and safety ground buses installed; fully pre-wired
- Label backlighting pre-installed
- "ON" indicating LEDs installed in all circuit positions
- Maximum panel amperage - 50 A
- Model 8409 has an AC Amp meter and an AC voltmeter



Item	Model	Positions	Color	Dimensions W x H x D	Ship	Net
201707	8077	30 A Main only	Graphite	2.63" x 3.75" x 2.5"	1 lbs	\$89.99
200814	8027	30 A Main + 6	Graphite	5.25" x 7.5" x 2.5"	2 lbs	189.99
201007	8409	30 A Main + 3	Graphite	5.25" x 7.5" x 3"	3 lbs	302.99

NOTE: Breaker panels with blank spaces are A Series

**BLUE SEA SYSTEMS VOLTMETERS FOR PANELS**

- 8003 DC analog voltmeter and 8235 DC digital meter
- 8-16 Volt DC analog/0-60 Volt DC digital
- 3 position switch for multiple battery banks
- Voltmeter mounted in 0.125" aluminum 5052 alloy



Item	Model	Type	Color	Dimensions W x H	Ship	Net
201561	8015	Analog	Graphite	5.25" x 3.75"	1 lbs	\$93.99
200831	8051	Digital	Graphite	5.25" x 3.75"	1 lbs	199.99

**BLUE SEA SYSTEMS DC BRANCH CIRCUIT BREAKER PANELS**

- All positive, negative and grounding buses installed
- Fully pre-wired, most in 12 and 24 Volt DC
- Includes set of 30 common DC labels
- Label backlighting pre-installed
- "ON" indicating LEDs installed in all circuit positions



Item	Model	Positions	Color	Dimensions W x H x D	Ship	Net
200813	8025	3 horiz.	Graphite	5.25" x 3.75" x 2.5"	2 lbs	\$129.99
201159	8096	6 horiz.	Graphite	10.5" x 3.75" x 2.5"	3 lbs	212.99
201005	8023	8	Graphite	5.25" x 7.5" x 2.5"	2 lbs	184.99
242256	8385	8 horiz.	Graphite	10.5" x 4.5" x 2.5"	3 lbs	189.99
200992	8068	13 with 2 meters	Graphite	10.5" x 7.5" x 3"	5 lbs	439.99
242257	8264	24 horiz.	Graphite	14.75" x 7.5" x 2.5"	8 lbs	517.99

NOTE: Breaker panels with blank spaces are A Series

**BLUE SEA SYSTEMS DC BRANCH CIRCUIT BREAKER PANEL**

- (8) positions, ON-indicating LEDs
- Max. 80 Amp, 12 Volt DC
- 8 - push button reset only circuit breakers - 10 Amp
- Dimensions: 4.88" W x 7.75" H x 3.50" D

Item	201813	1457	Ship	2 lbs	Net	\$139.99
------	--------	------	------	-------	-----	----------

**BLUE SEA SYSTEMS AC MAIN CIRCUIT BREAKER PANEL**

- 30 A main + (3) 15 A positions with 0-150 Volt AC analog voltmeter, ON-indicating LEDs
- Max. panel amperage: 50 A, 120 VAC
- Dimensions: 5.25" W x 7.50" H x 2.50" D

Item	201704	8043	Ship	2 lbs	Net	\$221.99
------	--------	------	------	-------	-----	----------

**BLUE SEA SYSTEMS AC BRANCH CIRCUIT BREAKER PANEL**

- (8) Positions; ON-indicating LEDs • Max. 100 A @ 120 Volt AC
- (5) 15 A breakers and (3) blank positions
- Dimensions: 5.25" W x 7.50" H x 2.50" D

Item	201705	8059	Ship	2 lbs	Net	\$184.99
------	--------	------	------	-------	-----	----------



**BLUE SEA SYSTEMS WATER RESIST ACCESS PANEL**

- Pre-wired harness included in all panels for easy installation
- Silicon breaker boots and gasket protects against water ingress
- Illuminated Carling Technologies 15 A circuit breaker switch allows the ability to shut off panel preventing parasitic draw
- Polycarbonate/ABS panel face is UV-stabilized, flame retardant, and will not corrode
- 12 Volt DC only

Item	Model/Description	Ship	Net
205095	4363 12 Volt DC Socket, USB	1 lbs	\$44.99
205096	4364 Two Blank Sockets	1 lbs	22.99
205097	4365 12 Volt DC Socket, 2 USB	1 lbs	58.99
205098	4366 12 Volt DC Socket, USB, Voltmeter	1 lbs	82.99
205099	4367 15 A Circuit Breaker, Three Blank Socket	1 lbs	26.99
205100	4368 12 Volt DC Socket, 2 USB, Voltmeter	1 lbs	99.99
205101	4369 Four Blank Socket	1 lbs	37.99



For more than 35 years, Paneltronics has been a leading provider of onboard electrical

panels, components and systems designed to last. Paneltronics offers a full range of electrical panels that can be customized – choose the right breaker sizes, labels, finishes, backlighting, etc. for your boat!

**PANELTRONICS AC CIRCUIT BREAKER PANELS**

- 30 A main, 3 Position AC Panel:** (3) 15 A circuits, 5-1/2" W x 6" H x 3-1/2" D
- 30 A main, 6 Position AC Panel:** (1) 10 A (2) 15 A (1) 20 A circuits, (2) blank circuits 5-1/2" W x 8-1/4" H x 3-1/2" D



Note: Reverse polarity trip coils automatically trip main breaker upon sensing reverse polarity.

Item	Model	Description	Ship	Net
201248	9982313B	3-position AC panel	3 lbs	\$149.99
201247	9972313B	3-position AC panel with LED indicators	3 lbs	154.99
201244	9982305B	6-position AC panel	3 lbs	157.99
201243	9972305B	6-position AC panel with LED indicators	3 lbs	169.99

**PANELTRONICS DC CIRCUIT BREAKER PANELS**

- 3 Position DC Panel:** 1 each 5, 10, 15 A circuits, 5-1/2" W x 4-1/2" H x 3-1/2" D
- 8 Position DC Panel:** (2) 5 A, (1) 10 A, (1) 15 A, (1) 20 A, 3 blank circuits 5-1/2" W x 8-1/4" H x 3-1/2" D



Item	Model	Description	Ship	Net
201241	9982207B	3-position DC panel	2 lbs	\$79.99
201240	9972207B	3-position DC panel with LED indicators	2 lbs	95.99
201239	9982204B	8-position DC panel	3 lbs	137.99
201238	9972204B	8-position DC panel with LED indicators	3 lbs	142.99



**BLUE SEA SYSTEMS WEATHERDECK™ WATERPROOF CIRCUIT BREAKER-DC TOGGLE**

- Rated IP67 - temporary immersion for 30 minutes
- Designed for flybridge and open-cockpit applications
- Independent label backlighting allows switching and dimming
- Compatible with all Blue Sea Systems digital dimmers
- Each panel can be mounted in four different orientations
- UV stabilized and weather resistant faceplate
- Constructed from corrosion resistant materials
- Green LEDs illuminate circuit labels
- SquareFormat label set 4215 included
- Maximum amp: 15 A @ 12 Volt DC (per circuit)
- 9 A @ 24 Volt DC (per circuit)



Item	Model	Description	Ship	Net
204493	4374	4 Position, 12 or 24 Volt DC	1 lbs	\$89.99
204494	4376	6 Position, 12 or 24 Volt DC	2 lbs	107.99
242254	4378	8 Position, 12 or 24 Volt DC	2 lbs	149.99

**BLUE SEA SYSTEMS WEATHERDECK WATERPROOF DC PANELS-FUSE MODEL: BICOLORED**

- Bi-colored LED quickly reveals on, off or blown circuits
- Illuminated circuit labels are visible in low light conditions
- Panels can be mounted in four different orientations
- Uses ATO/ATC fuses on each circuit
- Maximum amperage per circuit: 15 A
- 15 A ATO/ATC fuses installed

Item	Model	Positions	Color	Dimensions W x H x D	Ship	Net
242250	4302	2	Gray	3.88" x 2.6" x 2.5"	1 lbs	\$48.99
204495	4304	4	Gray	3.88" x 4.3" x 2.5"	1 lbs	75.99
204445	4306	6	Gray	3.88" x 6" x 2.5"	2 lbs	102.99
242252	4308	8	Gray	3.88" x 7.7" x 2.5"	2 lbs	142.99



**BLUE SEA SYSTEMS WATER RESIST SWITCH PANEL**

- Illuminated 15 A circuit breakers provide switching, "ON" indication and overcurrent protection
- Industry-standard sizes and mounting allow these panels to be easily retrofitted
- Polycarbonate/ABS panel surface is UV-stabilized, flame retardant, and will not corrode
- Silicon breaker boots and gasket protects against water ingress
- Two-wire connection for powering all panels is simple and requires #10 ring terminals
- Terminals screw to bus bars for secure connections
- Set of 15 square format circuit labels are included, and are easy to replace

Item	Model/Description	Ship	Net
205092	4320 12 V / 15 A 4 position, Gray	1 lbs	\$29.99
205093	4321 12 V / 15 A 4 position, USB, 12V socket, Gray	2 lbs	49.99
205094	4322 12 V / 15 A 6 position, Gray	2 lbs	37.99





**BLUE SEA SYSTEMS DIGITAL DC VOLTMETER**

Voltage range from 0 to 60 Volt DC. 3 levels of brightness, splashproof front and manual sleep mode. Applicable for 12, 24, 32, 36, and 42 Volt DC systems.

Item	Model	Dimensions	Ship	Net
204455	8235	2.43" H x 2.90" W x 3.40" D	1 lbs	\$165.99



**BLUE SEA SYSTEMS ANALOG DC AMMETERS**

Simple 2-wire connection from shunt, no other power required. Includes appropriate external DC shunt when required. 2.25" H x 2.75" W x 1.75" D.

Item	Model	Current Range	Ship	Net
201551	8005	0 - 25 A (internal shunt)	1 lbs	\$38.99
201553	8017	0 - 100 A	1 lbs	69.99
201554	8018	0 - 150 A	1 lbs	69.99
201555	8019	0 - 200 A	1 lbs	87.99



**BLUE SEA SYSTEMS DIGITAL DC AMMETER WITH ALARM\***

Displays current range from -500 to +500 A. 3 levels of display brightness, splashproof front and manual sleep mode. Includes shunt.

Item	Model	Dimensions	Ship	Net
204442	8236	2.43" H x 2.90" W x 3.40" D	2 lbs	\$187.99



**BLUE SEA SYSTEMS DIGITAL DC MULTIMETER WITH ALARM\***

Displays voltage range from 0 to 60 Volt DC, current range from -500 to +500 A. 3 levels of brightness, splashproof front, manual sleep mode, high and low voltage audio and visual alarms.

Item	Model	Dimensions	Ship	Net
204443	8248	2.43" H x 2.90" W x 3.40" D	2 lbs	\$234.99



\*Operates in negative side of circuit only. Shunt shifter required for positive side installation.

**BLUE SEA SYSTEMS MINI OLED DC VOLTMETER**

Voltage range from 8 to 36 Volt DC. Current draw: 15 mA max. Monitors DC voltage on a bright, waterproof, daylight-readable OLED screen

Item	Model	Size	Ship	Net
202347	1733	1-5/8" O.D.	1 lbs	\$42.99
205031	1732	1.56" O.D.	1 lbs	75.99



**BLUE SEA SYSTEMS ANALOG DC VOLTMETER**

Monitors nominal 12VDC systems, backlighting powered by separate 12 or 24VDC power source

Item	Model	Dimensions	Ship	Net
201550	8003	2.25" H x 2.75" W x 1.75" D	1 lbs	\$36.99



Single Pole



Double Pole



Surface Mount

**BLUE SEA A-SERIES TOGGLE CIRCUIT BREAKERS • BLACK • AC/DC All Ship 1 lbs**

Item	Model	Description	Net	Item	Model	Description	Net
202215	7200	Single pole 5 A	\$16.99	7212	Single pole 20 A	\$16.99	
	7204	Single pole 10 A	16.99	7216	Single pole 25 A	16.99	
	7208	Single pole 15 A	16.99	7220	Single pole 30 A	16.99	

**BLUE SEA A-SERIES TOGGLE CIRCUIT BREAKERS • WHITE • AC/DC**

202214	7202	Single pole 5 A	16.99	7214	Single pole 20 A	16.99	
	7206	Single pole 10 A	16.99	7218	Single pole 25 A	16.99	
	7210	Single pole 15 A	16.99	7222	Single pole 30 A	16.99	

**BLUE SEA A-SERIES TOGGLE CIRCUIT BREAKERS • BLACK • AC/DC**

202218	7232	Double pole 10 A	33.99	7237	Double pole 30 A	33.99	
	7236	Double pole 20 A	33.99	7239	Double pole 40 A	33.99	

**BLUE SEA A-SERIES TOGGLE CIRCUIT BREAKERS • WHITE • AC/DC**

202217	7233	Double pole 10 A	33.99	7238	Double pole 30 A	33.99	
	7235	Double pole 15 A	33.99	7240	Double pole 40 A	33.99	
	7260	Double pole 20 A	33.99				

**BLUE SEA 187 SERIES CIRCUIT BREAKERS • DC**

202220	7135	Surface mount 25 A	67.99	7138	Surface mount 40 A	67.99	
	7136	Surface mount 30 A	67.99	7139	Surface mount 50 A	67.99	
	7137	Surface mount 35 A	67.99	7140	Surface mount 60 A	67.99	

**BLUE SEA TOGGLE GUARD**

• Protect toggle circuit breakers from accidental switching  
• Fits all A-series single-pole toggle circuit breakers  
• Uses circuit breaker mounting screw holes  
• Includes (2) #6 flat head mounting screws

Item	Model	Ship	Net
200627	4100	1 lbs	\$3.79



**BLUE SEA MARINE-GRADE SHORT STOP DC CIRCUIT BREAKERS**

• Push-to-Reset Operation, Disconnects when Tripped, Waterproof Rating: IP64  
• Replace Fuse with a Breaker, Select Amperage  
• Material: Corrosion Resistant, Red Insulating Boot Included

Item	Specify Amperage	Ship	Net
205052	10 Amps - 50 Amps	1 lbs	\$8.99



**BLUE SEA SHORT STOP REPLACEMENT CIRCUIT BREAKER BOOT**

• Pre-cut for Easy Wiring from any Angle  
• Meets ABYC Insulation Requirements

Item	Model	Description	Ship	Net
205053	7160	Replacement Boot	1 lbs	\$0.99



**UNIVERSAL LAMP SOCKET**

Non-indexed double contact bayonet base (BA15D) lamp socket. Brass. Outside diameter: 11/16", 8" wire leads. Accepts lamp numbers: 64, 68, 82, 88, 90, 210, 1004, 1076, 1130, 1142, 1158, 1176, 1178.



Item 204581	Model 26100	Net \$9.99
-------------	-------------	------------

**Ignition Switches**

**M-550 IGNITION SWITCH**

All brass switch. (3) positions: Off - Ignition - Ignition/Start. Brass screw terminals. Electrical rating at 12 Volt DC:

10 A ignition, 5 A start. Suitable for 6 - 36 Volt DC applications. Coded tumbler lock, (2) keys. Fits panel thickness up to 1". Mounting stem: 13/16" - 24 x 1-7/32".

Item	Model	Net
204594	M-550 BP	\$26.99



**3 POSITION IGNITION SWITCH**

All plastic body switch. Three positions - Off-Ignition-Ignition /Start. Fits panels up to 7/8". Fits standard 7/8" hole. Impact-resistant body cannot corrode. Includes PVC boot for added weather protection. Two keys with each lock. Security locks have different key codes. 6-36V: 15A ignition, 5A start. Three nickel silver screw terminals. Key is removable only in the off position; spring return to IGN.

Item 204601	Model M-850 BP	Net \$23.99
-------------	----------------	-------------

**Toggle Switches**

**ON-OFF TOGGLE SWITCH • SPST 10A@12 VOLT DC**

• Plastic housing with steel-plated cap  
• Chrome-plated brass stem and mounting hardware  
• 15/32-32 threaded stem 15/32" long for up to 1/4" panels

Item	Model	Description	Net
204590	M-484 BP	On/Off, 2 screws	\$8.49
204595	M-584 BP	On/Off, 6" leads	8.99



**ON-OFF TOGGLE SWITCH • SPST 25A@12 VOLT DC**

• Black nylon handle; nickel-plated face nut  
• 15/32-32 threaded stem 15/32" long for up to 1/8" panels  
• Silver contacts  
• All ship 1 lbs

Item	Model	Description	Net
202091	54100 BP	On/Off, 2 screw terminal	\$6.99



**SPST/SPDT/DPDT • 25A@12 VOLT DC TOGGLE SWITCH**

• Plastic housing with steel-plated cap; Silver contacts  
• Nickel-plated stem and mounting hardware  
• 15/32-32 threaded stem 15/32" long for up to 1/4" panels

Item	Model	Description	Net
202086	5582 BP	SPST, On/Off, 2 screw	\$6.59
202087	5586 BP	SPDT, On/Off/On, 3 screw	7.49
202089	55021 BP	SPDT, (On)/Off/(On), 3 screw	7.99
202088	55054 BP	DPDT, (On)/Off/(On), 6 screw	14.99
202090	5592 BP	DPDT, On/Off/On, 6 screw	10.99



**Push/Pull Switches**

• 10A @12 Volt DC • Brass case, chrome plated brass button  
• For 6-36 Volt DC • Face nut, washer and Hex nut included

**SPDT OFF (PUSH)-ON (PULL 1) - ON (PULL 2)**

Item	Model	Description	Net
204593	M-531 BP	1-1/4" stem for 1" panels, 3/8-32 thread	\$24.99



**SPST OFF (PUSH)-ON (PULL)**

Item	Model	Mounting Description	Net
204589	M-482 BP	3/8"-32 thread, 1-1/4" L, sealed	\$14.99
204599	M-628 BP	3/8" - 32 thread, 1-1/4" L	13.99
204596	M-606 BP	3/8" - 32 thread, 1-1/4" L, with wire leads	16.99



**Push Button Switches**

• Brass case, chrome-plated brass button and face nut  
• For 6-36 Volt DC • Face nut, washer and hex nut included  
• 10A @ 12 Volt DC

**SPST OFF-(ON) NORMALLY OFF**

Item	Model	Mounting Panel Thickness	Net
204591	M-485 BP	Up to 3/4", brass, 5/8" - 32 dia.	\$12.99
204592	M-492 BP	Up to 1", brass, 5/8" - 32 dia.	15.99
204598	M-626 BP	Up to 1", brass, 5/8" - 32 dia.	15.99



**SPST ON-(OFF) NORMALLY ON**

202115	M-639 BX	Up to 3/4", brass, 5/8" - 32 dia.	13.99
--------	----------	-----------------------------------	-------

**SB-SPST OFF-(ON) NORMALLY OFF**

204597	M-608 BP	Up to 1/2", brass, 5/8" - 32 dia.	16.99
--------	----------	-----------------------------------	-------

**TOGGLE & BUTTON ACCESSORIES**

Item	Model	Description	Net
202084	81264 BP	Boot toggle, Gray	\$6.49
202085	81255 BP	Half boot toggle, Gray	6.79
202092	83280-03 BP	Push button cap, Black	2.49





**BLUE SEA CONTURA II SWITCH**

- Single pole / single throw
- Color: Black with Red lens
- Common application: Lights
- Vibration, shock, thermoshock, moisture and salt spray resistant
- Action: Off/On
- Voltage: 12 / 24 Volt DC

Item **204918** Model **7929** Ship 1 lbs Net **\$10.99**

**BLUE SEA WATER RESISTANT CONTURA III SWITCHES**

- Vibration, shock, thermoshock, moisture and salt spray resistant
- Specially manufactured for mounting in Blue Sea Systems' water resistant panels
- Ignition protected - safe for installation aboard gasoline powered boats
- Meets UL 1500 and ISO8846 ignition protection requirements



<b>Indicator light life</b>	100,000 hour half life
<b>Temperature rating</b>	-40° C to +85° C
<b>Current rating</b>	20A @ 12 Volt DC, 15A @ 24 Volt DC
<b>Mounting hole</b>	1.45" x 0.83" (36.83 mm x 21.08 mm)
<b>LED amperage</b>	18 mA
<b>Seals</b>	Internal and external gasket panel seal

Item	Color	Pole/Throw	Action	LEDs	Ship	Net
201735	Gray or Black	SPST	Off/On	1	1 lbs	\$10.99
201734	Gray or Black	SPST	Off/(On)	0	1 lbs	10.99
201738	Gray or Black	SPDT	On/Off/On	2	1 lbs	13.49
201737	Gray or Black	SPDT	(On)/Off/On	1	1 lbs	13.49
201736	Gray or Black	SPDT	(On)/Off/(On)	0	1 lbs	13.49
201740	Gray or Black	DPST	Off/On	1	1 lbs	12.99
201739	Gray or Black	DPST	Off/(On)	0	1 lbs	12.99
201743	Gray or Black	DPDT	On/Off/On	2	1 lbs	17.99
201742	Gray or Black	DPDT	(On)/Off/On	1	1 lbs	18.99
201741	Gray or Black	DPDT	(On)/Off/(On)	0	1 lbs	17.99

**COLE HERSEE M-58031 SERIES ROCKER SWITCHES** All ship 1 lbs.

- Electrical rating: 20A @ 12 VDC
- Panel hole size: .83" x 1.45"

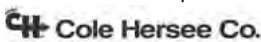

Item	Model	Blades	Pole/Throw	Action	Net
204766	M-58031-01-BP	2	SPST	Off/On	\$12.99
204767	M-58031-07-BP	2	SPST	Off/(On)	11.99
204768	M-58031-02-BP	3	SPDT	On/OFF/On	11.99
204769	M-58031-04-BP	4	DPST	Off/On	13.99



**BLUE SEA SYSTEMS MEGA/AMG FUSES**

The MEGA fuses provide a low cost method of protecting high amperage circuits such as inverters and electric windlasses. All models are rated for a maximum of 32 Volt DC.

Please specify Amps: 100, 125, 150, 175, 200, 250 or 300  
Item **202395** Ship 1 lbs Net **\$9.99**

**BLUE SEA SYSTEMS ATO/ATC FUSES** Sold in packages of 2.  
Please specify Amps: 1, 2, 3, 4, 5, 7.5, 10, 15, 20, 25, 30 or 40  
Item **202355** Ship 1 lbs Net **\$1.99**

**BLUE SEA SYSTEMS MARINE AGC FUSES** Sold in packages of 5.  
Please specify Amps: 1, 2, 3, 5, 7, 10, 15, 20, 25 or 30  
Item **205065** Ship 1 lbs Net **\$1.99**



**BLUE SEA SYSTEMS FUSE KITS**

Item	Model	Description	Ship	Net
204924	5289	40 AGC fuses 1-30 A and heavy duty in-line AGC/MDL fuse holder	1 lbs	\$15.99
204925	5290	30 EasyID ATC 3-40 A fuses and fuse puller (kit)	1 lbs	35.99

**BLUE SEA SYSTEMS WATERPROOF IN-LINE ATO/ATC FUSE HOLDER**

- Fuse type: ATO / ATC fuses (sold separately)
  - Max rating: 30 Amp
  - Holder type: Waterproof in-line
  - Max voltage: 32 Volt DC, Wire size: 12 AWG
- Item **204993** Model **5065** Ship 1 lbs Net **\$7.99**

**BLUE SEA ST-BLADE BATTERY TERMINAL MOUNT FUSE BLOCK KIT**

- Fuse type: ATO / ATC / easyID, Fuse block: (4) circuits
  - Mounts on the battery terminal stud
  - Kit includes a 4-circuit negative busbar and write-on labels
- Item **204976** Model **5024** Ship 1 lbs Net **\$29.99**

**BLUE SEA SYSTEMS SINGLE MRBF TERMINAL FUSE BLOCK**

- Fuse type: (1) Marine rated battery fuse (sold separately)
  - Rating: 300 Amp
  - Stud: 5/16" (battery post, switch or bus bar), Voltage: 58 Volt DC
  - Insulating cap prevents accidental shorts
- Item **204661** Model **5191** Ship 1 lbs Net **\$22.99**

**BLUE SEA SYSTEMS MEGA/AMG SAFETY FUSE BLOCK**

- Sealed cover protects MEGA or AMG fuses from the marine environment and provides IP66 ingress protection and satisfies ABYC/USCG insulation requirements
  - Max. voltage: 32 Volt DC • 300A max. with 4/0 cable
  - Ignition protected - safe on gasoline powered boats
  - Terminal stud size: 5/16 (M8) • Terminal screw size: 5/16 (M8)
- Item **204920** Model **7721** Ship 1 lbs Net **\$27.99**



**BLUE SEA STAINLESS STEEL PUSH BUTTON LED RING SWITCHES**

- 10A continuous
- Single pole double throw or single pole single throw
- Can be wired for normally open or normally closed
- Installs with .110" quick connects (included)



Item	Model	Positions	Backlight	Ship	Net
205102	4160	OFF-ON	Blue	1 lbs	\$21.99
	4161	OFF-(ON) Momentary	Blue	1 lbs	21.99
	4162	OFF-ON	Red	1 lbs	21.99
	4163	OFF-(ON) Momentary	Red	1 lbs	21.99

**BLUE STAINLESS STEEL PUSH BUTTON LED RING SWITCHES**

- 20A Continuous
- Illuminates when output is on
- Single pole single throw
- 14 AWG pigtail - positive & load connections
- Installs with .110inch quick connects - LED ground (included)



Item	Model	Positions	Backlight	Ship	Net
205103	4190	OFF-ON	Blue	1 lbs	\$52.99
	4192	OFF-ON	Red	1 lbs	52.99

**BLUE SEA SYSTEMS BACKLIT PUSH BUTTON SWITCHES**

- Pole/Throw: SPST
- 15 Amps @ 12 Volt DC maximum operating amperage
- 3" bare wire pigtail
- Fits panels 1-6 mm thick
- Material: Stainless steel w/ Silver alloy contacts



Item	Model	Positions	Ship	Net
205087	4180	OFF-ON	1 lbs	\$52.99
	4181	OFF-(ON) Momentary	1 lbs	52.99
205088	4230	50-Piece label kit	1 lbs	13.49



**BLUE SEA WEATHERDECK TOGGLE SWITCHES**

- SPST - Single pole, single throw; Action: On/Off
- Rating: 10A @ 250 Volt AC, 15 A@125 Volt AC, 15A @12 Volt DC - (2) .250 terminals
- Designed for use in Blue Sea Systems WeatherDeck waterproof panels

Item	Model	Description	Ship	Net
201328	4150	Toggle switch	1 lbs	\$6.49
200650	4138	Toggle switch boot	1 lbs	4.29

**BLUE SEA SYSTEMS SOURCE SELECTION ROTARY SWITCH**

- 30 Amp
- Switches: (2) 120 or 230 Volt AC sources
- Heavy duty, industrial-rated switch with intuitive function

Item	Model	Positions	Ship	Net
201008	9009	OFF + 2	1 lbs	\$117.99

**COLE HERSEE INLINE FUSE CONNECTOR 20A**

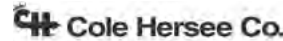

Includes 20 A fuse. Accepts glass fuses (SFE up to 20 A and 3AG [AGC] fuses up to 30 A). Twist-lock securely holds the fuse and will not open accidentally. 8" 14 AWG wire leads.

Item **204582** Model **3031-20 BP** Ship 1 lbs Net **\$3.79**



**BLUE SEA ST BLADE COMPACT FUSE BLOCKS**

- Rating: 30 Amp / circuit
- Max. voltage: 32 Volt DC
- Maximum total amp per block: 100 Amp
- Insulating cover meets ABYC / USCG insulation requirements
- Fuses (sold separately)

Item	Model	Fuse Type	Ship	Net
202349	5045	(4) ATO / ATC	1 lbs	\$26.99
202350	5046	(8) ATO / ATC	1 lbs	39.99

**BLUE SEA SYSTEMS ST BLADE FUSE BLOCK - 6 INDEPENDENT CIRCUITS**

- Fuse type: (6) ATO / ATC fuses (sold separately)
- Rating: 30 aAp / circuit (40 Amps per jumped circuit group)
- Max. operating voltage: 32 Volt DC
- Insulating cover meets ABYC / USCG insulation requirements

Item	Model	Ship	Net
204954	5035	1 lbs	\$33.99

**BLUE SEA SYSTEMS ST BLADE FUSE BLOCKS - COMMON SOURCED**

- Clear insulating cover with label recesses and storage for two fuses, satisfies ABYC / USCG insulation requirements
- Easy to open, push button latch for easy access to fuses
- Tin-plated copper buses and fuse clips
- Fuse blocks include covers and 20 write on circuit labels
- Max. amperage per circuit 30 A • ATO / ATC fuses
- Max. amperage per block 100 A • Max. voltage rating: 32 Volt DC
- Positive distribution bus with #10-32 stud

Item	Model	Description	Ship	Net
204397	5025	6 circuit with negative bus, with cover	1 lbs	\$38.99
204398	5026	12 circuit with negative bus, with cover	1 lbs	47.99
201714	5028	6 circuit, without negative bus, with cover	1 lbs	33.99
200895	5029	12 circuit, without negative bus, with cover	1 lbs	43.99



**Ancor**

Ancor's marine grade terminals differ from automotive terminals as they are designed for the harsh marine environment. Their nylon insulators are easy to crimp and will not split. Their barrels are designed to tightly grip the wire, and its tinned copper construction gives the least electrical resistance but the most corrosion protection.

**HEAT SHRINK BUTT SPLICE CONNECTORS** All ship 1 lbs.

Item	Model	Wire Range	Pieces	Net
202362	309025	22-18 AWG	25	\$20.99
	309125	16-14 AWG	25	20.99
	309225	12-10 AWG	25	27.99



**SINGLE CRIMP NYLON BUTT CONNECTORS** All ship 1 lbs.

Item	Model	Wire Range	Pieces	Net
202371	210100	22-18 AWG	25	\$6.99
	210110	16-14 AWG	25	6.99
	210120	12-10 AWG	25	10.99



**NYLON SNAP PLUGS (MALE/FEMALE)** All ship 1 lbs.

Item	Model	Wire Range	Quantity	Net
202374	210709	22-18 AWG	25 (male)	\$13.99
	210708	22-18 AWG	25 (female)	11.99
	210718	16-14 AWG	25 (male)	12.49
	210719	16-14 AWG	25 (female)	13.99



**NYLON .250 QUICK DISCONNECTS** All ship 1 lbs.

Item	Model	Wire Range	Quantity	Net
202373	210819	16-14 AWG	25 (male)	\$8.99
	210818	16-14 AWG	25 (female)	8.59
	210829	12-10 AWG	25 (male)	11.99
	210828	12-10 AWG	25 (female)	11.99



**NYLON RING TERMINALS** All ship 1 lbs.

Item	Model	Wire Range	Ring Size	Net
202416	210203	22-18 AWG	#10	\$8.99
202417	210211	16-14 AWG	#6	8.99
	210212	16-14 AWG	#8	8.99
	210213	16-14 AWG	#10	8.99
	210214	16-14 AWG	1/4"	10.99
	210216	16-14 AWG	3/8"	10.99



**NYLON FLANGED SPADES** All ship 1 lbs.

Item	Model	Wire Range	Ring Size	Net/25 Pack
202369	210302	22-18 AWG	#8	\$8.99
	210312	16-14 AWG	#8	8.99
	210323	12-10 AWG	#10	11.99



**HEAT SHRINK ADHESIVE LINED TUBING** Color: Black. All ship 1 lbs.

Item	Size	Length	Qty/Pkg	Net
202419	1/8"	3"	3	\$2.89
	1/8"	6"	10	12.99
202420	3/16"	3"	3	3.29
	3/16"	6"	10	15.99
202421	1/4"	3"	3	3.99
	1/4"	6"	10	19.99

**HEAT SHRINK BUTT CONNECTOR/TERMINAL KIT ASSORTMENT**

- Kit wire range: 22-10 AWG (assorted)
- Package: 10 pack
- Item 200445 Model 300000 Ship 1 lbs Net \$10.99

**Tools & Tool Kits**

**BLUE SEA MINI CLAMP MULTIMETER**

- True RMS - required for accurate measurement of inverters
- Measures AC and DC current in wires without disturbing circuits
- Auto-range operation: 0.01-400 AAC/ADC, 0.001-600 VAC/VDC
- Large digital display • Test leads included with meter
- Item 204656 8110 Ship 1 lbs Net \$152.99

**SEA-DOG HEAT SHRINK TERMINAL CRIMPER TOOL**

- Crimps 22 - 10 AWG heat shrink terminals
- Powder coated steel • Dimensions: 9" L x 2-3/16" W
- Item 756093 429920-1 Ship 1 lbs Net \$34.99

**SEA-DOG DELUXE TERMINAL CRIMPER TOOL**

- Crimps 22-10 AWG terminals • Material: Powder coated steel
- Item 201911 429910-1 Ship 2 lbs Net \$28.99

**ANCOR STAINLESS STEEL MULTI-TOOL**

- Crimp 10-22 AWG insulated/non-insulated terminals and coaxial connectors
- Cut and strip 8-22 AWG solid and 10-24 AWG stranded wire
- Cut and rethread 4-40, 5-40, 6-32, 8-32, 10-24, 10-32 screws
- Item 204414 Model 701009 Ship 1 lbs Net \$28.99



Item	Model	Description	Ship	Net
202278	703024	Mini pocket torch	1 lbs	\$24.99
202279	703064	Turbo light	1 lbs	17.99
202280	703060	Pro torch	1 lbs	57.99
202284	703010	Single crimp ratcheting crimp tool	2 lbs	67.99
202285	703030	Double crimp ratcheting crimp tool	2 lbs	67.99

**BSP**

Clear Seal is the latest advancement in an expanding line of patented and innovative heat shrink connectors. The Clear Seal proprietary tubing features increased clarity, better abrasion resistance, greater tensile strength, 50% more dielectric strength and improved shrink times compared to competing nylon or polyolefin terminals.

**CLEAR SEAL HEAT SHRINK BUTT SPLICE CONNECTORS** 25 pieces. All ship 1 lbs.

Item	Model	Wire Range	Pieces	Net
202429	37130	22-18 AWG	25	\$11.99
	37330	16-14 AWG	25	11.99
	37430	12-10 AWG	25	13.99



**CLEAR SEAL RING HEAT SHRINK TERMINALS** 25 pieces. All ship 1 lbs.

Item	Model	Wire Range	Ring Size	Net
202425	37113	22-18 AWG	#8	\$11.99
	37114	22-18 AWG	#10	11.99
202426	37313	16-14 AWG	#8	11.99
	37314	16-14 AWG	#10	11.99
	37316	16-14 AWG	5/16"	11.99
	37317	16-14 AWG	3/8"	11.99

**CLEAR SEAL HEAT-SHRINK BUTT TERMINAL ASSORTMENT**

- Includes (12) pieces of each size adhesive lined connectors
- Wire gauge: 12-10 AWG, 16-14 AWG and 22-18 AWG
- Item 202461 Ship 1 lbs Net \$15.99



**CLEAR SEAL STEP DOWN BUTT SPLICES CONNECTORS**

- Marine grade terminals
- Heat-shrink, adhesive lined, waterproof connections
- Item 202462 Wire Range Color Pieces Ship Net
| 202462 | 22-18 to 16-14 | Blue | 6 | 1 lbs | \$7.99 |
|  | 16-14 to 12-10 | Yellow | 6 | 1 lbs | 9.99 |



**CLEAR SEAL 3-WAY SPLICE CONNECTORS**

Item	Wire Range	Color	Pieces	Ship	Net
202463	22-18	Pink	6	1 lbs	10.99
	16-14	Blue	6	1 lbs	11.99
	12-10	Yellow	6	1 lbs	12.99



**CLEAR SEAL 4-WAY SPLICE CONNECTORS**

Item	Wire Range	Color	Pieces	Ship	Net
202464	22-18	Pink	6	1 lbs	\$11.99
	16-14	Blue	6	1 lbs	13.99
	12-10	Yellow	6	1 lbs	15.99



**CLEAR SEAL QUICK DISCONNECT TERMINALS**

Item	Wire Range	Color	Pieces	Ship	Net
202465	22-18	Pink	6	1 lbs	\$2.99
	16-14	Blue	6	1 lbs	2.99
	12-10	Yellow	6	1 lbs	3.99



**CLEAR SEAL SPADE FLANGE TERMINALS**

Item	Wire Range	Screw	Color	Pieces	Ship	Net
202466	22-18	#8	Pink	6	1 lbs	\$3.49
	16-14	#8	Blue	6	1 lbs	3.49
	12-10	#8	Yellow	6	1 lbs	3.99
	22-18	#10	Pink	6	1 lbs	3.49
	16-14	#10	Blue	6	1 lbs	3.49
	12-10	#10	Yellow	6	1 lbs	3.99



**CLEAR SEAL KITS**

- Item Model Description Ship Net
- © 201982 99305 Terminal kit 1 lbs \$99.99
- © 201983 99112 Electrical splice kit 2 lbs 79.99
- © 201986 99168 Waterproof wiring kit 3 lbs 89.99
- © 201984 99120 Heat shrink terminal installation kit 7 lbs 289.99



**COOL SEAL** is the most innovative and cost effective sealed electrical connector to hit the market in 25 years. This heatless, solderless terminal utilizes revolutionary anaerobic sealant technology that installs in a fraction of the time of comparable heat seal connectors.

COOL SEAL BUTT SPLICE CONNECTORS

- No need for torches or heat guns, reducing installation time and improving productivity
- Simply strip the wire and crimp, activating the sealant, to create an environmentally sealed connection
- Nylon insulation provides maximum abrasion and puncture resistance
- Seamless, 99.9% ETP, tinned, copper connector offers optimal electrical conductivity

**COOL SEAL BUTT SPLICE CONNECTORS**

Item	Wire Range	Pieces	Net	Wire Range	Pieces	Net
202467	22-18 AWG	6	\$3.99	16-14 AWG	25	\$14.99
	22-18 AWG	25	14.99	12-10 AWG	6	4.99
	16-14 AWG	6	4.49	12-10 AWG	25	17.99



**HEAT SHRINK ELECTRICAL TERMINAL ASSORTMENT KIT**

- Includes ClearSeal butt splices, ClearSeal ring terminals and Crimp 'n Seal quick disconnects (120 pieces total)
- Wire range: 22-18, 16-14 and 12-10 gauge
- Heat activated adhesive built into the sleeve
- Item 202468 Ship 1 lbs Net \$64.99



**FULLY INSULATED CRIMP N SEAL .250 QUICK DISCONNECTS** All Ship 1 lbs.

Item	Model	Wire Range	Pieces	Net	Model	Wire Range	Pieces	Net
202428	30388	16-14 AWG	25 (male)	\$14.99	30488	12-10 AWG	25 (male)	\$16.99
	30398	16-14 AWG	25 (female)	14.99	30498	12-10 AWG	25 (female)	16.99





**ANCOR** Marine Grade™ wire is manufactured from tinned copper stranding for maximum protection against corrosion and electrolysis. Ultra flexible (Type 3) stranding resists fatigue caused by vibration and flexing. ANCOR's proprietary premium vinyl insulation stays flexible even in extreme cold and resists salt water, battery acid, oil, gasoline and ultraviolet radiation. Exclusive insulation is rated at 600 volts, 221° F dry and 167° F wet, and is resistant to heat and abrasion. Exceeds all UL 1426, USCG Charterboat (CFR Title 46) and ABYC standards.

**Ancor**

**Wire By the Foot & Spool**

**BATTERY CABLE- SOLD BY THE FOOT** All Ship 1 lbs / ft.

Item	Wire Size	Specify Color	Ship	Net/Ft.
204850	4/0 AWG	Red or Black	1 lbs	\$9.99
204108	2/0 AWG	Red or Black	1 lbs	6.79
204109	1/0 AWG	Red or Black	1 lbs	5.49
204123	1 AWG	Red or Black	1 lbs	4.99
203794	2 AWG	Red or Black	1 lbs	3.89
203792	4 AWG	Red or Black	1 lbs	2.49
201353	6 AWG	Red or Black	1 lbs	1.79

**50' BATTERY CABLE SPOOLS**

204849	4/0 AWG	Red or Black	44 lbs	\$397.99
201363	6 AWG	Red or Black	7 lbs	74.99

**25' BATTERY CABLE SPOOLS**

204848	4/0 AWG	Red or Black	24 lbs	\$239.99
204603	2/0 AWG	Red or Black	15 lbs	146.99
204169	1/0 AWG	Red or Black	11 lbs	117.99
204609	2 AWG	Red or Black	7 lbs	79.99
204412	4 AWG	Red or Black	5 lbs	54.99
201352	6 AWG	Red or Black	3 lbs	38.99

**PRIMARY WIRE SOLD BY THE FOOT**

204167	8 AWG	Green, Red or Black	1 lbs	\$1.19
--------	-------	---------------------	-------	--------

**100' SPOOLS PRIMARY WIRE**

204647	8 AWG	Green, White, Yellow, Red or Black	8 lbs	\$82.99
204652	10 AWG	Green, White, Yellow, Red or Black	5 lbs	47.99
204659	12 AWG	Green, White, Yellow, Red or Black	3 lbs	32.99
204664	14 AWG	Green, White, Yellow, Red or Black	3 lbs	25.99
204671	16 AWG	Green, White, Yellow, Red or Black	2 lbs	18.99
204675	18 AWG	Green, White, Yellow, Red or Black	2 lbs	16.99

**35' SPOOLS PRIMARY WIRE**

204674	18 AWG	Red or Black	1 lbs	\$7.99
--------	--------	--------------	-------	--------

**25' SPOOLS PRIMARY WIRE**

204611	8 AWG	Green, Yellow, Red or Black	2 lbs	\$30.99
204650	10 AWG	Red, Brown, Green, White or Yellow	2 lbs	23.99
204658	12 AWG	Black, White or Yellow	1 lbs	15.99
204670	16 AWG	Green, White, Yellow, Red, Black, Brown or Purple	1 lbs	7.69

**18' SPOOLS PRIMARY WIRE**

204663	14 AWG	Green, White, Red, Black, Blue or Purple	1 lbs	\$8.29
--------	--------	------------------------------------------	-------	--------

**12' SPOOLS PRIMARY WIRE**

204657	12 AWG	White, Yellow, Red or Black	1 lbs	\$8.29
--------	--------	-----------------------------	-------	--------

**8' SPOOLS PRIMARY WIRE**

205108	10 AWG	Red or Black	1 lbs	\$8.29
--------	--------	--------------	-------	--------

**BATTERY LUGS (2-PACKS)** High voltage ANCOR Marine Grade™ lugs are manufactured from heavy duty annealed tinned copper. 100% tin plated copper resists corrosion. Seamless barrel design allows for maximum strength when crimped. Closed end design seals out moisture - cables stay dry and corrosion free. All Ship 1 lbs.

Item	Model	Wire Size	Screw Size	Net	Item	Model	Wire Size	Screw Size	Net
202408	252233	8 AWG	#10	\$2.29	202411	252264	2 AWG	1/4"	\$5.49
	252234	8 AWG	1/4"	2.99		252265	2 AWG	5/16"	5.49
	252235	8 AWG	5/16"	2.99		252266	2 AWG	3/8"	7.29
	252236	8 AWG	3/8"	2.99	202412	252274	1 AWG	1/4"	5.29
202409	252244	6 AWG	1/4"	4.39		252275	1 AWG	5/16"	5.49
	252245	6 AWG	5/16"	4.39		252276	1 AWG	3/8"	5.49
	252246	6 AWG	3/8"	4.39	202413	252285	1/0 AWG	5/16"	5.99
202410	252254	4 AWG	1/4"	4.39		252286	1/0 AWG	3/8"	5.99
	252255	4 AWG	5/16"	4.99	202414	252295	2/0 AWG	5/16"	7.29
	252256	4 AWG	3/8"	4.99		252296	2/0 AWG	3/8"	7.29
					202415	252275	4/0 AWG	5/16"	10.99
						252276	4/0 AWG	3/8"	10.99

**ANCOR TINNED COPPER BATTERY TERMINAL SET - 1 PAIR**

Item	Description	Ship	Net
204529	(1) positive / (1) negative; Stud: 5/16" / 3/8"	1 lbs	\$29.99



**Ancor Tools & Tape**

703005	703005	Wire and cable cutters	2 lbs	\$27.99
202282	703006	Heavy duty wire and cable cutters	4 lbs	107.99
205078	703075	Battery cable stripper	1 lbs	31.99
205077	703112	15' mini fish tape	1 lbs	14.99



**Flat & Coaxial Cable**

**ANCOR FLAT SAFETY DUPLEX CABLE**

- White outer jacket is made for easy removal and provides the best abrasion resistance available
- Inner conductors are correctly color-coded to ABYC standards.



Item	Wire Size	Conductor Colors	Length	Ship	Net
202515	8/2 AWG	Red/Yellow	50'	3 lbs	\$99.99
200307	10/2 AWG	Red/Yellow	25'	3 lbs	33.99
200309	10/2 AWG	Red/Yellow	100'	13 lbs	114.99
200305	12/2 AWG	Red/Yellow	100'	8 lbs	79.99
200301	14/2 AWG	Red/Yellow	25'	2 lbs	24.99
200302	14/2 AWG	Red/Yellow	100'	6 lbs	56.99
200299	16/2 AWG	Red/Yellow	100'	5 lbs	44.99
200296	18/2 AWG	Red/Yellow	100'	4 lbs	35.99

**ANCOR FLAT SAFETY DUPLEX ELECTRICAL CABLE - SOLD BY THE FOOT**

Traditional red/black duplex wire also available

204996	18/2 AWG	Red/Yellow	Per foot	1 lbs	\$0.49
204997	16/2 AWG	Red/Yellow	Per foot	1 lbs	0.59
202358	14/2 AWG	Red/Yellow	Per foot	1 lbs	0.79
204998	12/2 AWG	Red/Yellow	Per foot	1 lbs	1.09
202236	10/2 AWG	Red/Yellow	Per foot	1 lbs	1.49
202516	8/2 AWG	Red/Yellow	Per foot	1 lbs	2.79

**ANCOR FLAT TRIPLEX CABLE**

(3) marine grade primary conductors in a White outer jacket.

Item	Wire Size	Conductor Colors	Length	Ship	Net
205107	8/3 AWG	White/Black/Green	25'	8 lbs	\$107.99
205081	10/3 AWG	White/Black/Green	100'	17 lbs	147.99
203702	12/3 AWG	White/Black/Green	25'	4 lbs	44.99
203706	12/3 AWG	White/Black/Green	100'	13 lbs	109.99
203705	14/3 AWG	White/Black/Green	100'	11 lbs	79.99
203699	16/3 AWG	White/Black/Green	100'	7 lbs	57.99

**ANCOR FLAT TRIPLEX CABLE - SOLD BY THE FOOT**

Item	Wire Size	Conductor Colors	Length	Ship/Ft	Net/Ft
204999	16/3 AWG	White/Black/Green	Per foot	1 lbs	\$0.79
205000	14/3 AWG	White/Black/Green	Per foot	1 lbs	1.09
205001	12/3 AWG	White/Black/Green	Per foot	1 lbs	1.59
204946	10/3 AWG	White/Black/Green	Per foot	1 lbs	2.19
205106	8/3 AWG	White/Black/Green	Per foot	1 lbs	3.99

**ANCOR COAXIAL CABLE**

Premium tinned copper. Color: White.

Item	Wire Size	Outside dia.	Length	Ship/Ft	Net/Ft
255007	RG-8X	1/4"	Per foot	1 lbs	\$0.99
201802	RG-59U	1/4"	Per foot	1 lbs	0.89
204604	RG-213	13/32"	100' spool	12 lbs	115.99/100'

**ANCOR ROUND SIGNAL CABLE**

(8) conductors. White outer jacket.

Item	Wire Size	Conductor Colors	Ship/Ft	Net/Ft
205002	20/8	Black, Red, Green, Blue, Brown, Orange, Purple and Yellow	1 lbs	\$1.29

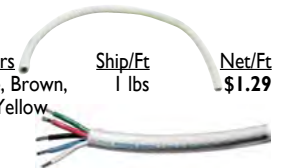

**ANCOR ROUND MAST CABLE**

(5) conductors. White outer jacket.

Item	Wire Size	Conductor Colors	Ship/Ft	Net/Ft
205003	14/5	Green, Red, Black, White, Blue	1 lbs	\$2.19

**ANCOR ROUND BILGE PUMP CABLE**

(3) conductors. Gray outer jacket.

Water and oil resistant.

Item	Wire Size	Conductor Colors	Ship	Net
205004	14/3	Black, Brown, Red	1 lbs	\$1.39/ft.



**ANCOR GTO 15 HIGH VOLTAGE CABLE - 25' SPOOL**

Premium tinned copper. High voltage (15000 Volt). Color: White.

Applications: HAM and SSB antenna installations (not for VHF or TV antennas)

Item	Wire Size	Outside dia.	Cable Color	Ship	Net
204035	14	1/4"	White	1 lbs	\$15.99



**ANCOR PREMIUM PVC ELECTRICAL TAPE**

- Material: low-lead 7-mil PVC
- Maximum voltage: Up to 600 Volt
- Maximum temp: Up to 220 degrees F
- Dimensions: 3/4" W x 66' L

Please specify color: Black, Blue, Brown, Green, Orange, Red, White, Yellow

Item 205019 Ship 1 lbs Net \$4.99



❖ For more detailed product specifications and our complete selection visit [www.defender.com](http://www.defender.com) or call 800-628-8225. ❖



**BLUE SEA SYSTEMS COMMON BUS BARS** All ship 1 lbs.



Insert molded studs, tin-plated copper buses and stainless steel screws.

<b>MiniBus - 100A</b> - cont. 100A AC/DC, Max. 300 Volt AC/48 Volt DC Mounting holes accept #10 (M5) screws					
Item	Model	Cover	Terminal Screws	Terminal Studs	Net
201444	2304	No cover	5 x #8-32	2 x #10-32	\$12.49
204612	2314	With cover	5 x #8-32	2 x #10-32	13.99
204613	2315	With cover		4 x #10-32	16.99
<b>Common BusBar - 150A</b> - cont. 130A AC/150A DC, Max. 130V AC/48V DC Mounting holes accept #10 (M5) screws					
204450	2300	With cover	10 x #8-32	2 x 1/4"-20	18.99
201439	2301	No cover	10 x #8-32	2 x 1/4"-20	16.49
201440	2302	No cover	20 x #8-32	2 x 1/4"-20	23.99
201441	2303	No cover		4 x 1/4"	20.99
204616	2715	Cover for Bus Bar 2301/2303			3.99
<b>DualBus plus - 150A</b> - cont. 130 A AC/150 A DC, Max. 300 Volt AC/48 Volt DC Mounting holes accept #10 (M5) screws					
200599	2722	With cover	5 per bus x #10-32	2 per bus x 1/4"-20	\$26.99
<b>PowerBar - 600A</b> - cont. 545A AC/600 A DC, Max. 300 Volt AC/48 Volt DC Mounting holes accept 1/4" Screws					
201460	2104	No cover	4 x #8-32	4 x 3/8"-16	\$87.99
<b>DualBus-100A common</b> - cont. 100 A AC/DC, Max. 300 Volt AC/48 Volt DC Combines + and - bus on one block with a clear snap on cover.					
Item	Model	Cover	Terminal Screws	Mounting holes	Net
201442	2701	No cover	5 per bus x #8-32	Accept #10 (M5)	\$15.99
201443	2702	No cover	10 per bus x #8-32	Accept #10 (M5)	19.99
<b>ANL® Fuse Block - 300A</b> - Max. 32V DC					
200891	5005			5/16"-18	23.99

**BLUE SEA SYSTEMS TERMINAL BLOCKS** All Ship 1 lbs.

These are the highest quality terminal blocks available. They are closed back, which, unlike the cheaper open back styles, provide complete electrical and moisture insulation. Nickel plated brass.

2400 Series (20 A/300 V)			2500 Series (30 A/600 V)			2600 Series (65A/600 V)			
Circuit	Item	Model	Net	Item	Model	Net	Item	Model	Net
2	202396	2402	\$3.29	202397	2502	\$4.19	202398	2602	\$7.69
4		2404	3.99		2504	5.49		2604	10.99
6	Specify circuits	2406	5.49	Specify circuits	2506	7.49	Specify circuits	2606	16.99
8		2408	6.49		2508	8.69		2608	19.99
10		2410	8.69		2510	9.49		2610	21.99

Each screw pair is one isolated circuit

**BLUE SEA CABLE CLAM**

Waterproof, removable cable entry through deck without cutting off connectors. Allows installation of radar, GPS, VHF and other cables without the expense, time and risk of cutting factory installed connections. Cam is easily installed and cable can be quickly removed. All ship 1 lbs.

Item	Model	Max Connector	Max Dia.	Installation	Net
252315	1001	.680"	0.31"	GPS	\$18.99
252316	1002	0.83"	0.44"	VHF	19.99
252317	1003	1.40"	0.56"	Radar	20.99

**SEA-DOG POLARIZED CABLE OUTLETS**

Chromed brass polarized socket, polarized plug and cover cap  
• Rating: 3A (Max) • 12 or 24 Volt DC  
Item 203630 Model 426142-1 Ship 1 lbs Net \$8.99

**WIRE MANAGEMENT BY ANCOR**

Permits flexible routing of cable harnesses, provides abrasion protection and allows lead-outs at any point.

Item	Model	Description	Ship/Ft	Net/Ft
204851	453386	Self extinguishing split loom, 3/8"	1 lbs	\$0.79
204852	453756	Self extinguishing split loom, 3/4"	1 lbs	1.19
204853	452385	Spiral wrap, 3/8"	1 lbs	0.89
204854	452505	Spiral wrap, 1/2"	1 lbs	0.69
204855	452755	Spiral wrap, 3/4"	1 lbs	1.59
204856	452905	Spiral wrap, 1"	1 lbs	2.69

**WESTERN PACIFIC TRADING STAINLESS STEEL CABLE TIES**

• Tensile strength: 250 lbs • (12) per bag • All ship 1 lbs.

Item	Model	Size	Net
756715	30404	.30" x 8"	\$2.99
	30408	.30" x 14"	3.99
	30412	.30" x 20"	4.99
	30414	.30" x 26"	5.99

**NYLON CABLE CLAMPS** All ship 1 lbs.

Item	Dia.	Screw size	Color	Qty/Pkg	Net
202344	3/16"	#8	Natural	25	\$3.59
	1/4"	#8	Natural	25	4.19
	3/8"	#8	Natural	25	4.89



**NEWMAR®**

**PX Series Waterproof Junction Boxes**

- Ideal for making wiring connections above or below decks, even in areas subject to spray
- Rugged, non-corrosive, high impact polypropylene
- Snap-on cover provides watertight seal
- "Universal" cut-to-fit graduated diameter cable entries accommodate wide cable range
- Multiple position connector strips with "captive" screw compression wire terminals installed - meets ABYC standards (same type as CS-1)
- Multiple knockouts provided for conduit access (in addition to cable entries)
- IEC waterproof rating: IP55 - Water projected in jets against the enclosure from any direction shall have no harmful effects

Item	Model	Box Size	Terminals	Max Wire	Ship	Net
204662	PX-1	2.95" x 2.95" x 1.66"	1 x 6	16 AWG	1 lbs	\$28.99
204667	PX-2	3.35" x 3.35" x 1.66"	2 x 6	16 AWG	1 lbs	32.99
204668	PX-3	4.45" x 4.45" x 2.29"	2 x 9	16 AWG	1 lbs	47.99

**Scanstrut Waterproof Junction Boxes for up to 8 Cables**



Junction Box



Deluxe Junction Box with Cable Seals

The new "fit and forget" junction box range is the perfect sailing accessory for anyone planning boat maintenance. Providing secure, watertight connections for marine electrical cables onboard any boat, they are manufactured from a glass reinforced plastic and provide capacity for up to 8 cables to enter the box.

**SB-8-5 - 5-Way Terminals**

- Rating: 400 V / 32 A
- Max cable dia: 12 mm / 1/2"
- Wire sizes: 16-11 AWG

**SB-8-10 - 10-Way Terminals**

- Rating: 600 V / 20 A
- Max cable dia.: 12 mm / 1/2"
- Wire sizes: 28-12 AWG

Must use item 201930 to get IP67 protection

Item	Model	Description	Ship	Net
201931	SB-8-5	Standard junction box (5-term-screw down)	1 lbs	\$18.99
201932	SB-8-10	Deluxe junction box (10 fast-fit term)	1 lbs	32.99
201930	SB-2G	Cable seal pack (2 per pack)	1 lbs	9.99

**Scanstrut Deck Seals**

- Easy, reliable and watertight installation
- No need to remove cable connectors
- Multi-functional dome shape



Plastic deck seal



Horizontal deck seal



Multi deck seal



Thru bulkhead cable seal

**PLASTIC** (Also available in stainless steel - Please call for pricing)

Item	Model	Description	Ship	Net
258090	DS16-P	Mini deck seal - for connectors up to Ø16 mm (0.63"). Cables from 2 - 8 mm (0.08"-0.35")	1 lbs	\$18.99
258091	DS21A-P	Small deck seal - for connectors up to Ø21 mm (0.83"). Cables from 4 - 9 mm (0.165"-0.35")	1 lbs	18.99
258092	DS21B-P	Small deck seal - for connectors up to Ø21 mm (0.83"). Cables from 9 - 14 mm (0.35"-0.55")	1 lbs	18.99
258093	DS30-P	Medium deck seal - for connectors up to Ø30 mm (1.18"). Cables from 9 - 14 mm (0.35"-0.55")	1 lbs	20.99
258094	DS40-P	Large deck seal - for connectors up to Ø40 mm (1.57"). Cables from 12 - 15 mm (0.47"-0.59")	1 lbs	21.99

**IMPACT RESISTANT NYLON MICRO DECK SEALS**

Item	Model	Description	Ship	Net
260109	DS6-P	Micro deck seal - deck seal for cables 2 mm - 6 mm (0.08" - 0.24")	1 lbs	11.99
260110	DS-H6	Micro deck seal - horizontal deck seal for cables 2 mm - 6 mm (0.08" - 0.24")	1 lbs	13.99

**ANODIZED ALUMINUM MULTI DECK SEAL**

Item	Model	Description	Ship	Net
258100	DS-Multi	Multi deck seal - will accept multiple cables up to Ø15 mm (0.71"). Self-drill only	1 lbs	49.99

**THRU BULKHEAD - HIGH STRENGTH NYLON WITH INTERNAL SEAL**

Item	Model	Description	Ship	Net
259003	TBH-4	Fits 4 holes for 16 mm (0.63") cables	1 lbs	\$32.99
	TBH-10	Fits 10 holes for 7 mm (0.28") cables	1 lbs	32.99



# Aqua Signal Navigation Lights



20202-7



20200-7



20040-7



20180-7

## Incandescent - Halogen

**SERIES 20** • For Powerboats < 39 feet • 12 VDC • 5 Watts • All Ship 1 lbs.

Item	Model	Description	Visibility	Housing	Mount	Height	Net
701297	20202-7	Starboard or Port	1 NM	Black	Side-mount	2.1"	\$25.99
701512	20300-7	Starboard or Port	1 NM	Black	Deck	2"	31.99
701295	20040-7	All-round pedestal	2 NM	Black	Pedestal	4"	24.99
701296	20180-7	All-round fold-down	2 NM	Black	All-round	18"	108.99

## Incandescent

**SERIES 22** • For powerboats < 39 feet • 12 VDC • 10 Watts • All Ship 1 lbs.

Item	Model	Description	Visibility	Housing	Mount	Height	Net
701071	22246-7	All-round	2 NM	Silver (pole)	Plug-in	24"	\$24.99
701298	22100-7	Bi-color	1 NM	Black	Deck	2.24"x1.75"H	17.99

22246 (Base Not Included)



44200-7

44201-7

44500-7

44501-7

## SERIES 44 LED NAVIGATION LIGHTS

• Side mount; mounting holes are identical with side mount versions of Series 41 and Series 43

• For vessels < 164 feet • 12 or 24 VDC • Visibility: 2 NM

Item	Model	Description	Housing Color	Ship	Net
701777	44300-7	Port Red	Black	1 lbs	\$119.99
701778	44301-7	Port Red	White	1 lbs	119.99
701778	44200-7	Starboard Green	Black	1 lbs	119.99
701778	44201-7	Starboard Green	White	1 lbs	119.99
701778	44500-7	Stern White	Black	1 lbs	119.99
701778	44501-7	Stern White	White	1 lbs	119.99



25100-7

25400-7

25404-7

25000-7

## SERIES 25 CLASSIC Incandescent

• For Vessels < 39 feet • 12 VDC • 10 Watts • Side mount/mast mount • All Ship 1 lbs

Item	Model	Description	Visibility	Housing	Net
700234	25100-7	Bi-color	1 NM	Black	\$28.99
701513	25200-7	Starboard or port	1 NM	Black	27.99
700237	25400-7	Masthead	2 NM	Black	28.99
700238	25500-7	Stern	2 NM	Black	28.99
700239	25404-7	Masthead/foredeck	2 NM	Black	72.99
700015	25000-7	All-round White	2 NM	Black	24.99



33203 Starboard - White



33302-7 Port - Black



33502-7

33100-7

## SERIES 33 LEDS

• Item 701134 and 701135 for vessels < 164 feet • 1.5 Watts  
• Item 701291 and 701292 for vessels < 65 feet • 3 Watts  
• 12 VDC • All Ship 1 lbs.

Item	Model	Description	Visibility	Housing	Net
701134	33302-7	LED starboard or port side light	2 NM	Black or White	\$46.99
701135	33502-7	LED stern/transom light	2 NM	Black or White	49.99
701291	33100-7	LED bi-color navigation light	2 NM	Black	67.99
701292	33101-7	LED bi-color navigation light	2 NM	White	67.99



34000-7



34606-7



34706-7



34410-7

## AQUA SIGNAL SERIES 34 LED NAVIGATION LIGHTS

• For vessels < 65 feet • 12/24 VDC • All ship 1 lbs  
• All-Round: 3" diameter, 1.25" Height; masthead and tricolor, 3.5" diameter, 4" Height; Tricolor/anchor, masthead/anchor, 3.5" diameter, 5.5" height

• USCG certified with sensor that flashes when visibility no longer meets minimum standards

Item	Model	Description	Watts	Housing	Net
701378	34000-7	All-round, White	1	Black or White	\$95.99
701380	34002-7	All-round, Green	1	Black or White	95.99
701379	34004-7	All-round, Red	1.3	Black or White	134.99
701382	34606-7	Tri-Color w/Quicfit base	1.9	Black or White	159.99
701384	34706-7	Tri-Color/Anchor w/Quicfit base	1.9/1	Black or White	229.99
701381	34400-7	Masthead White 225 w/Quicfit base	2.1	Black or White	127.99
701383	34410-7	Masthead/Anchor w/ Quicfit base	2.1/1	Black or White	219.99



40700-7



40100-7



40000-7



40807-7

## SERIES 40 LIGHTS - INCANDESCENT

• For Vessels < 65 feet • 12 VDC • Black Housing

Item	Model	Description	Visibility	Watts	Ship	Net
700275	40700-7	Tri-color/Anchor, pedestal mount	2 NM	25/10	2 lbs	\$189.99
700276	40706-7	Tri-color/Anchor, Quicfit base	2 NM	25/10	1 lbs	209.99
700277	40806-7	Tri-color/Anchor/Strobe, Quicfit base	2/2/3NM	25/10/8	2 lbs	459.99
700278	40808-7	All-round Anchor/Strobe, Quicfit base	2/3 NM	10/8	2 lbs	409.99
700279	40600-7	Tri-color light	2 NM	25	1 lbs	115.99
700280	40606-7	Tri-color light with Quicfit base	2 NM	25	2 lbs	136.99
700253	40200-7	Starboard	2 NM	25	1 lbs	94.99
700254	40300-7	Port	2 NM	25	1 lbs	94.99
700255	40100-7	Bi-color	2 NM	25	1 lbs	93.99
700256	40400-7	Masthead	3 NM	25	1 lbs	93.99
700257	40500-7	Stern	2 NM	10	1 lbs	93.99
700269	40000-7	All-round light	2 NM	10	1 lbs	74.99
700281	40807-7	Safety strobe light	3 NM	8	2 lbs	379.99



41100-7



41200-7



41500-7



41404-1

## SERIES 41 NAVIGATION LIGHTS - INCANDESCENT

• For Vessels < 65 feet • 12 VDC • Housing: Black • All Ship 1 lbs

Item	Model	Description	Visibility	Watts	Net
700245	41100-7	Bi-color navigation light	2 NM	25 W	\$69.99
700243	41200-7	Starboard navigation light	2 NM	25 W	69.99
700244	41300-7	Port navigation light	2 NM	25 W	69.99
700246	41400-7	Masthead White navigation light	3 NM	25 W	69.99
701707	41501-1	Stern navigation light, White housing	2 NM	10 W	69.99
701707	41500-7	Stern navigation light, Black housing	2 NM	10 W	69.99
800102	41404-1	Combo masthead/foredeck lamp	3 NM	25/50 W	225.99
701107	41201-1	Port navigation light, White housing	2NM	25 W	69.99
701107	41301-1	Starboard navigation light, White housing	2NM	25 W	69.99



43100-7



3108201000

## SERIES 43 LED NAVIGATION LIGHTS

• For Vessels < 164 feet • 12/24 VDC • 1.5 Watts • All Ship 1 lbs

Item	Model	Description	Visibility	Housing	Net
701045	43100-7	Bi-color; 3W	2 NM	Black or White	\$249.99
701579	3108201000	Combo masthead/foredeck lamp	3 NM	Black or White	479.99



# Hella Navigation Lights



## HELLA INCANDESCENT NAVIGATION LIGHT

Compact navigation lamps with timeless styling. Anti-magnetic and waterproof. Positive ventilation. Snap-type lens attachment goes in place without screws. Black housing. 12 Volt DC.

For boats under 40'

Item	Model	Fig. Description	Ship	Net
700129	998505001	A Mast/deck light - flexible mounting arms	1 lbs	\$63.99
700134	995003021	B Masthead/anchor combo-8" fold down	1 lbs	44.99
700136	003562045	C Bi-color bow light	1 lbs	19.99
700137	003562035	D Port light - Red	1 lbs	18.99
700138	003562025	E Starboard light - Green	1 lbs	18.99
700139	003562015	F Stern light - White	1 lbs	18.99
700140	003562005	- Masthead light	1 lbs	18.99

For boats under 65'

700426	002984315	G Bi-color light	1 lbs	\$55.99
700425	002984325	H Stern light - White	1 lbs	51.99
700422	002984335	I Port light - Red	1 lbs	51.99
700423	002984345	J Starboard light - Green	1 lbs	51.99
700424	998504001	K Masthead/deck light	3 lbs	99.99
700144	002984535	L Tri-color light	1 lbs	73.99
700145	002984601	M Tri-color and anchor light	2 lbs	99.99

## HELLA MARINE NAVILED 360 COMPACT ALL-ROUND LED NAVIGATION LIGHT

- Surface mount
- Operating voltage: 9-33 Volt DC
- Overall Height: 2.2"
- Light color: White
- Draw: Less than 1 watt

Please specify housing color: Black or White

Item	Description	Visibility	Ship	Net
701542	Compact all-round light	2 NM	1 lbs	\$78.99

## HELLA MARINE NAVILED® PORT & STARBOARD LED NAVIGATION LIGHTS

- Power consumption: less than 2 W
- Operating voltage: Multivolt™ 8-28 Volt DC
- Color: White

Item	Description	Visibility	Ship	Net
701082	(1) port and (1) starboard light	2 NM	1 lbs	\$154.99

## HELLA MARINE NAVILED TRIO TRI-COLOR WITH LED ANCHOR LAMP

- Ultra low current draw
- Port, starboard & stern draws less than 3.5 W (>0.29A @12 Volt DC)
- The anchor lamp draws less than 1.5 W (>0.13A @12 Volt DC)

Item	Model	Description	Visibility	Ship	Net
701081	980650001	Multivolt 9-33 Volt DC	2 NM	1 lbs	\$467.99

## HELLA NAVILED COMPACT LED NAVIGATION LAMPS - 2NM

- Completely sealed and uses less than 10% of the power required to run a bulb navigation lamp of the same visible distance
- Port and starboard lamps consume less than 2W combined
- Pre-wired with marine cable
- No bulbs, no maintenance; ultra long service life
- White housing

Item	Model	Description	Visibility	Ship	Net
701009	980520011	Port light with colored outer lens	2 NM	1 lbs	\$82.99
701010	980520211	Starboard light with colored outer lens	2 NM	1 lbs	82.99
701012	980520811	(1) port and (1) starboard Light	2 NM	1 lbs	154.99

## HELLA 2010 SERIES ALL-ROUND POLE LIGHTS - All ship 1 lbs

- Navigation/anchor lights
- Salt water resistant
- Bulb: 12 Volt DC/10 W SV8.5
- Black housing
- UV and impact-resistant plastic housing and lens
- Pre-wired with 100 mm of cable
- Includes stainless steel screws
- Minimum visible distance: 2 NM

Item	Model	Description	Net
A	700430 995002001	4" All-round - fixed base mount horizontally or vertically	\$24.99
B	700429 995002021	8" All-round - fold down mount horizontally or vertically	34.99
B	700450 995002051	12" All-round - fold down mount horizontally or vertically	39.99
B	700451 995002321	24" All-round - fold down mount horizontally or vertically	48.99



## HELLA NAVILED 360 FIXED POLE LED ANCHOR LIGHT - 2NM

Item	Model	Color	Length	Ship	Net
701787	980960201	Black	6"	1 lbs	\$79.99
	980960211	White	6"	1 lbs	79.99
	980960231	Black	8"	1 lbs	89.99
	980960241	White	8"	1 lbs	89.99

## HELLA NAVILED 360 FOLD DOWN LED ANCHOR LIGHT - 2NM

Item	Model	Color	Length	Ship	Net
701788	980960301	Black	12"	1 lbs	\$104.99
	980960311	White	12"	1 lbs	104.99
	980960341	Black	24"	1 lbs	117.99
	980960351	White	24"	1 lbs	117.99
	980960461	Black	40"	1 lbs	127.99
	980960471	White	40"	1 lbs	127.99



## HELLA NAVILED PRO-LEDS - 2 MILE All ship 1 lbs

- For Power and Sail boats up to 65'
- Each lamp draws less than 2.5 W
- Operating voltage: 9-33 Volt DC
- Shroud and sealed lamp design ensures reliable illumination
- Visibility: 2 NM
- 3.43" W x 3.54" H x 2.25" D

Item	Model	Housing/Light	Net
700832	959900011	White/Port	\$117.99
700833	959908011	White/Starboard	117.99
700834	959909011	White/Stern	117.99

Choose housing color: Black or White

## HELLA NAVILED PRO-LEDS - 3 MILE All ship 1 lbs

- Vertical surface mount
- Operating Voltage: 9 - 33 Volt DC
- 3.43" W x 3.54" H x 2.25" D
- Visibility: 3 NM
- Draws less than 2.5 W

Item	Model	Housing/Light	Net
700835	959900211	White/Red - port	\$134.99
700836	959908211	White/Green - starboard	134.99
700837	959909211	White/White - stern	134.99
700473	959940211	White/White - masthead	157.99
242248	959940201	Black/White - masthead	157.99



# Perko Navigation Lights

## PERKO HORIZONTAL MOUNT LIGHTS



## FOR VESSELS UNDER 40 FEET

Item	Model	Finish	Lens	Base	Height	Net
700762	0972DP0CHR	Chrome, brass top	Red/Green	2-3/8" Round	7/8"	\$51.99
700760	1310DP0CHR	Chrome, zinc top	Red/Green	4" x 3-1/8"	1"	38.99

## FOR VESSELS UNDER 65 FEET

700764	0227DP0CHR	Chrome-zinc	Red/Green	3-1/4" x 2-5/16"	5/8"	\$33.99
700765	0252MB0DPI	Chrome	Red/Green	3-1/2" x 2-1/4"	13/16"	49.99
700766	0252BB0DPI	Black	Red/Green	3-1/2" x 2-1/4"	13/16"	28.99
700767	0252WB0DPI	White	Red/Green	3-1/2" x 2-1/4"	13/16"	29.99
701139	0965DP0STS	Stainless steel	White	2-3/8" Round	7/8"	40.99

## PERKO INCANDESCENT STERN LIGHT

- Chrome plated brass top
- Vertical flush mount
- Black plastic base
- 12 Volt DC; draws .74 A

Item	Model	Size	Ship	Net
700195	0939DP112V	5-3/16" x 3-3/8"	1 lbs	\$102.99



## PERKO COMBINATION MASTHEAD/DECK SPREADER LIGHT

- Vertical surface mount
- Operating voltage: 12 Volt DC
- 12 Volt DC bulb
- Power consumption: 10 / 20 watts
- Dimensions: 4.12" W x 7.00" H x 4.75" D

Item	Model	Visibility	Light	Base	Ship	Net
701237	0170BMDDPI	3 NM	White	Black	1 lbs	\$96.99

## PERKO SERIES 1460 ALL-ROUND LIGHTS

- For vessels under 65 feet
- 12 Volt DC bulb
- Stowaway plug-in pole
- 3/4" diameter anodized tube
- 2 pin

## PERKO COMBINATION MASTHEAD/WHITE ALL-ROUND LIGHT

- Fixed pole mount
- Operating voltage: 12 Volt DC
- Power consumption: 10 watts

Item	Model	Visibility	Height	Light	Base	Ship	Net
701068	1196DP1CHR	3 NM	5-1/16" H	White	Black	1 lbs	\$43.99

## PERKO COMBINATION MASTHEAD AND ALL-ROUND LIGHT

- Chrome plated zinc all-round lights
- Clear lenses
- Folds down for easy storage
- 3/4" diameter tube
- (2) 12 Volt DC bulbs and 3NM visibility
- Uses #8 screw

Item	Model	Mount	Dim.	Dim. Bracket	Ship	Net
700193	1181DP0CHR	Horiz.	12-13/16" H	2" x 1-1/2"	1 lbs	\$51.99
700194	1184DP0CHR	Vert.	12-13/16" H	2-1/4" x 5/8"	1 lbs	51.99



## Navigation Lights



USCG certified; durable; waterproof; constant brightness; passive and active RF filtering; surge protection; in stock, made in USA. Signal Mate manufactures its own lights. Brackets included. 5 year warranty.

### SIGNAL MATE LED NAVIGATION LIGHTS FOR BOATS UP TO 164' (50 METERS)



- Vertical surface mount
- Operating voltage: 10-30 VDC
- Includes mounting bracket
- Housing color: Black
- Current draw: 0.1 Amp @ 12 VDC
- 1.5" W x 3.25" H

Item	Model	Visibility	Ship	Net
701430	2NM112R Port	2 NM	1 lbs	\$156.99
701431	2NM112G Starboard	2 NM	1 lbs	\$156.99
701432	2NM135W Stern	2 NM	1 lbs	\$156.99
701344	2NMPT/SB SET Port/starboard set	2 NM	2 lbs	\$299.99
701342	3NM360WP Anchor with photodiode	3 NM	1 lbs	\$219.99

### SIGNAL MATE LED COMBINATION TRI-COLOR NAVIGATION/ANCHOR LIGHT FOR BOATS UP TO 65' (20 METERS)

- Horizontal surface mount
- Light color: Tri-color/White
- Operating voltage: 10-30 VDC
- Includes mounting bracket
- Dimensions: 1.5" W x 4.5" H
- Housing color: Black
- Current draw: 0.3 Amp @ 12 VDC



Item	Model	Visibility	Ship	Net
701427	TRIANC3	2 NM	1 lbs	\$309.99

### TRI-COLOR NAVIGATION/ANCHOR LIGHT & PHOTODIODE

- Includes optional photodiode
- Automatically turns anchor light OFF at daylight, ON at dusk
- Includes mounting bracket
- Dimensions: 1.5" W x 4.5" H

Item	Model	Visibility	Ship	Net
701428	TRIANC3P	2 NM	1 lbs	\$327.99

## OGM

### OGM LED TRI-COLOR ANCHOR LIGHTS

- 2 NM visibility
- 2.7" x 2.7"
- Cast acrylic housing; anodized aluminum and acrylic lens
- \* Has a voltage range of 9-36 VDC
- Waterproof
- USCG approved
- 10-28 VDC



**LIFETIME WARRANTY!**

Item	Model	Description	Net
701057	LXTA-SP 12V	With photodiode and strobe	\$399.99
701060	LXTA-S 12V	With strobe	359.99
701061	LXA-P*	With photodiode	229.99

### OGM LED RUNNING LIGHTS

- Anodized aluminum housing and acrylic lens
- USCG approved • Waterproof
- 3.3" x 2.75" x 0.75"
- 2NM visibility
- 10-30 VDC

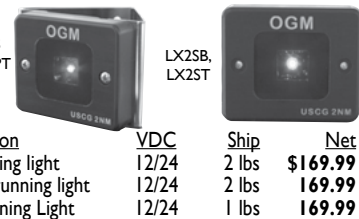

Item	Model	Description	VDC	Ship	Net
701063	LX2PT	Red port running light	12/24	2 lbs	\$169.99
701064	LX2SB	Green starboard running light	12/24	2 lbs	\$169.99
701062	LX2ST	White stern running Light	12/24	1 lbs	\$169.99

### SEA-DOG LED ALL-ROUND PONTOON NAVIGATION LIGHT

- Fold-down pole / deck mount; Light color: White; Housing color: Black
- Operating voltage: 12 VDC; Power consumption: 0.1 Watts
- Visibility: 2 NM; Dimensions: 3.375"W x 24"H x 1.25"D

Item	701313	400026-1	Ship 1 lbs	Net \$49.99
------	--------	----------	------------	-------------

### SEA-DOG LED MASTHEAD NAVIGATION LIGHT

- Fixed mount, Light color: White, Housing / base color: Black
- Operating voltage: 12 VDC
- Visibility: 2 NM, dimensions: 2.25" W x 4.31" H x 1.12" D



Item	701311	400022-1	Ship 1 lbs	Net \$44.99
------	--------	----------	------------	-------------

### SEA-DOG LED ALL-ROUND NAVIGATION LIGHT

- Fixed mount; Light color: White; Housing / base color: Black
- Operating voltage: 12 VDC • 3"W x 4.31"H x 1.12"D
- Visibility: 2 NM; Overall height: 4.313"



Item	701315	400042-1	Ship 1 lbs	Net \$41.99
------	--------	----------	------------	-------------

### SEA-DOG LED BI-COLOR NAVIGATION LIGHT

- Deck mount; Light color: Red / Green; Housing: stamped Stainless Steel with a cast 316 Stainless Steel base
- Operating voltage: 12 VDC
- Visibility: 2 NM; Dimensions: 2.25" W x 2.56" L x 1.00" H



Item	701323	400059-1	Ship 1 lbs	Net \$52.99
------	--------	----------	------------	-------------

### SEA-DOG LED PORT & STARBOARD NAVIGATION LIGHT PAIR

- Vertical surface mount; Light color: Red / Green; Housing: stamped 304 Stainless Steel
- Operating voltage: 12 VDC • Visibility: 2 NM; Dimensions: 2.62" W x 3.56" L x 0.75" H



Item	701309	400079-1	Ship 1 lbs	Net \$79.99
------	--------	----------	------------	-------------

### SIGNAL MATE LED BI-COLOR NAVIGATION LIGHT

- Vertical surface mount • Light color: Red / Green • Housing: Black
- Operating voltage: 10 - 30 VDC • Current draw: 0.180 Amp @ 12 VDC



### SIGNAL MATE LED COMBINATION MASTHEAD NAVIGATION LIGHT

- With wraparound mast mount bracket
- Power: 10-30 VDC; Draw: 0.160 Amp at 12 VDC
- Rugged, waterproof LED; 225-degree viewable
- For power and sailboats up to 20 M (65')

**BRACKET INCLUDED!**

Item	Model	Dimensions	Visibility	Ship	Net
701610	3NMMH225MMT	2.25"Wx4"Hx3.1"D	3 NM	1 lbs	\$264.99

### SIGNAL MATE LED COMBINATION MASTHEAD & DECK LIGHT

- Rugged, waterproof LED; 225° viewable • For Boats up to 20 M (65')
- Deck light with (3) White high brightness LEDs with Khatod 10 degree lens
- Deck light with (3) Red high brightness LEDs with Khatod 10 degree lens



701608	3NMMHDKW	White 2"Wx7.75"H	3 NM	2 lbs	\$547.99
701609	3NMMHDKR	Red 2"Wx7.75"H	3 NM	1 lbs	\$547.99

### SIGNAL MATE COMBINATION ANCHOR LIGHT WITH STROBE FOR DISTRESS

- Non photodiode • Switch included
- 3 wire to allow 1 per sec inland distress strobe

Item	Model	Dimensions	Visibility	Ship	Net
701662	3NM360WS	1.5"Wx3.25"H	3 NM	1 lbs	\$239.99

### SIGNAL MATE LED COMBINATION MASTHEAD NAVIGATION/ANCHOR LIGHT

- For commercial, power, sailboat vessels to 65 feet (20 meters)
- Horizontal surface mount • Switch included • Light color: White
- Housing: Black • Operating voltage: 10-30 VDC
- Current draw: 0.180/0.260 amps at 12 VDC



Item	Model	Dimensions	Visibility	Ship	Net
701429	3NMMHANC	1.5"Wx3.75"H	3 NM	1 lbs	\$279.99

### SIGNAL MATE LED MASTHEAD (STEAMING) LIGHT

- Designated for boats to 65 feet (20 meters)
- Bracket mount • Light color: White • Housing: Black
- Operating voltage: 10-30 VDC • Current draw: 0.16 Amp @ 12 VDC



Item	Model	Dimensions	Visibility	Ship	Net
701343	3NMMH225	1.5"W x 3.25"H	3 NM, 225°	7 lbs	\$215.99

### FORESPAR MAST LIGHTS

- Features an attractive polymer housing with a wrap-around mounting apron
- MLI and ML2 are molded polymer, 12 VDC
- Light A (ML1 LED) - 20 W halogen deck light or .36 amp LED
- Light B (ML2 LED) - 20 W halogen deck light or .36 amp LED decklight 10 W incandescent or .08A LED

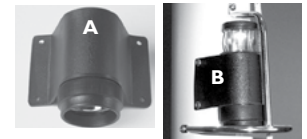

Item	Model	Description	Dim.	Wire Included	Net
700220	131000 (ML1)	A Decklight	3-5/8" vert.	6" twin lead	\$87.99
700221	132000 (ML2)	B Combo deck/bow	5-3/4" vert.	6" triple lead	89.99
701604	131300 (ML1)	A LED decklight	3-5/8" vert.	6" twin lead	112.99
701605	132300 (ML2)	B LED combo deck/bow	5-3/4" vert.	6" triple lead	144.99
700223	132200	Stainless Steel chafe guard			54.99

### Replacement Bulbs

Item	Bulb #	For Light #	Watts	Amps	Net
700225	132025	ML2 mast	10	.8	\$7.99
700458	132035	ML1, ML2 deck	20	1.4	32.99
701606	132325	ML2 LED upper bulb	1.05	.08	27.99
701607	132335	ML1 and ML2 LED bottom bulb	1.05	.36	34.99

### WHITECAP STAINLESS STEEL NAVIGATION LIGHTS



For vessels under 40'. 12 VDC (bulb included). All ship 1 lbs

Item	Model	Description	Lens	Dim. (L" x D")	Net
700201	S-111	Combo bow light	R/G	1-3/8 x 2-1/4	\$16.99
700203	S-115	Bow light; 225° Steaming light	Clear	1-3/8 x 2-1/4	15.99
700204	S-108	Stern light (flush)	Clear	1-3/8 x 2-1/4	14.99
700205	S-110	Masthead light	Clear	1-3/8 x 2-1/4	13.99
700226	S-955	Sternlight (flush transom mount)	Clear	5-3/16 x 3-1/8	22.99
700206	S-109	Sidelights, pair	R/G	4 x 2-1/8 x 1-1/2D	29.99
700202	S-918	Sidelights (flush), pair; USCG approved	R/G	7-7/8"L x 2-1/4"W x 2-1/2"D	42.99
701592	S-918LED	LED sidelights (flush), pair; USCG approved	R/G	7-7/8"L x 2-1/4"W x 2-1/2"D	82.99

❖ For more detailed product specifications and our complete selection visit [www.defender.com](http://www.defender.com) or call 800-628-8225. ❖



## Portable Navigation Lights

### Navisafe Navi light 360° LED Navigation Lights

Suitable for use on sailboats up to 39 ft. or powerboats up to 164 ft.

- USCG approved battery powered LED nav light • Power: (3) AAA batteries
- Double magnet bracket mount • Visibility: 2 NM
- Dimensions: 68 mm OD x 35 mm H
- Rugged build: Durable and impact resistant
- Waterproof: Floats in water with light facing up



- Cost effective; super bright LEDs
  - (5) operating/flashing modes
  - Push-button ON/OFF control
- | Item   | Model | Light                     | Housing Color   | Ship  | Net     |
|--------|-------|---------------------------|-----------------|-------|---------|
| 701438 | N-001 | White light               | Black           | 1 lbs | \$62.99 |
| 701439 | N-010 | White light               | Emergency Green | 1 lbs | 67.99   |
| 701440 | N-305 | Red/Green/White and White | Black           | 1 lbs | 66.99   |

For accessories and mounts please visit [www.defender.com](http://www.defender.com)

### Navisafe Navi light with Navimount

- Navilight LED 2 NM navigation lights
- Includes Navimount base

Item	Model	Light	Ship	Net
701759	045	360° Red	1 lbs	\$54.99
701676	340	White/Red/Green	1 lbs	61.99
701675	040	360° White	1 lbs	54.99



### Navisafe Navi light All-Round RB 2NM

Base will fit directly in many anchor winches and winches as well as Navisafe RAILBLAZA Sideport, Starport or RailMount.

- Includes RAILBLAZAS attachment
- Applications: RAILBLAZAS StarPort System (sold separately)
- Powered by (3) AAA batteries (not included)

### NAVISAFE NAVI LIGHT ALL-ROUND WHITE RB 2NM

- 5 Modes: 360° All-round light, 225° masthead light, 135° sternlight, flashing light, anchoring light, cabin light
- |      |        |       |    |      |       |     |         |
|------|--------|-------|----|------|-------|-----|---------|
| Item | 701596 | Model | 55 | Ship | 1 lbs | Net | \$54.99 |
|------|--------|-------|----|------|-------|-----|---------|



### NAVISAFE NAVI LIGHT TRICOLOR RB 2NM

Includes a green starboard light, red port light and white sternlight. Battery operated super bright LED light.

- 5 Modes: Tricolor masthead light (135° White, 112.5° Red, 112.5° Green), BiColor side light, red side light, green side light, white sternlight
- |      |        |       |     |      |       |     |         |
|------|--------|-------|-----|------|-------|-----|---------|
| Item | 701597 | Model | 355 | Ship | 1 lbs | Net | \$61.99 |
|------|--------|-------|-----|------|-------|-----|---------|



### Navisafe Multi-Function Light Packages

- Multifunctional all-round LED safety light • USCG approval: 2 nautical miles • Floatable, waterproof (20 m) and air-tight • Dual function suction mount - holds Navi light 360° S or GoPro® cameras (Hero/2/3) • (2) Self-adhering mounting plates to securely attach the light on abrasive surfaces
- Powered by (3) AAA batteries (not included)



Item	Model	Description	Ship	Net
701625	041	5 Modes: 360° all-round light, 225° masthead light, 135° sternlight, flashing light, anchoring light, cabin light	1 lbs	\$59.99
701626	341	5 Modes: TriColor masthead light (135° white, 112.5° Red, 112.5° Green), BiColor side light, Red side light, Green side light, White sternlight	1 lbs	66.99
701627	771	Contains model 041 and model 341 lights	2 lbs	114.99

### Navisafe Navilight Inflatable Dinghy Complete Kit

- "Total solution pack" for all dinghies, inflatables and skiffs
  - Contains the lights and mounts needed to equip most boats up to 39' with USCG approved navigation lights
- |      |        |       |     |      |       |     |          |
|------|--------|-------|-----|------|-------|-----|----------|
| Item | 701809 | Model | 769 | Ship | 3 lbs | Net | \$158.99 |
|------|--------|-------|-----|------|-------|-----|----------|



### Navisafe 360° Polelight Pack

- Mount any Navimount or convert for Scotty or RAILBLAZA mounts
  - Operating Voltage: (4) AA batteries (Not Included)
  - Visibility: 2 NM
  - Overall Length: 360 mm
  - Includes: Polelight, 3-piece-pole, Navimount vertical / 951 Black and Neoprene stowaway bag
- |      |        |       |     |      |       |     |         |
|------|--------|-------|-----|------|-------|-----|---------|
| Item | 701783 | Model | 763 | Ship | 2 lbs | Net | \$69.99 |
|------|--------|-------|-----|------|-------|-----|---------|



### Navisafe Navimount Pole Pack

- Portable mounts with Navilights
  - Mount: Horizontal or vertical surface
  - Maximum pole height: 30"
  - For Navilights with magnetic, Navimount and suction bases
  - Includes: 4-Piece-pole, Magnet holder, Navimount vertical / 950, Navimount horizontal / 952 and Neoprene stowaway bag
- |      |        |       |     |      |       |     |         |
|------|--------|-------|-----|------|-------|-----|---------|
| Item | 701677 | Model | 905 | Ship | 1 lbs | Net | \$43.99 |
|------|--------|-------|-----|------|-------|-----|---------|



### Aqua Signal Series 27 LED Compact Portable Lights

- All ship 1 lbs.

- Designed for small watercraft that are manually powered or less than 23' with speeds up to 7 knots
  - Compact 5-1/2" length lights • Seawater resistant
  - Requires (4) AAA batteries (not included)
  - Special plastic projector lens; All-round can be used as flashlight or spot light
- | Item   | Model   | Description                                                                               | Ship  | Net     |
|--------|---------|-------------------------------------------------------------------------------------------|-------|---------|
| 701574 | 27400-7 | Bow light: suction cup with 4.5" flexible arm with adapter and C-clamp                    | 1 lbs | \$25.99 |
| 701575 | 27440-7 | Sternlight: suction cup with 4.5" flexible arm with adapter, C-clamp, U-bracket, 24" pole | 2 lbs | 33.99   |



### Innovative Lighting LED Portable Navigation Lights

- Nominal Voltage: 4 x 1.5 Volt AA - Batteries not included
- Designed for boats less than 22 ft. in length, maximum speed of 7 kts

#### BI-COLOR BOW NAVIGATION LIGHT

- Suction cup mount • Dimensions: 2.53" OD x 6.18" L
  - Light color: Red/Green, Housing Color: White/Black
- |      |        |       |            |      |       |     |         |
|------|--------|-------|------------|------|-------|-----|---------|
| Item | 700687 | Model | 560-1110-7 | Ship | 1 lbs | Net | \$24.99 |
|------|--------|-------|------------|------|-------|-----|---------|



#### LED PORTABLE STERN NAVIGATION LIGHT

- Suction cup mount • Dimensions: 2.53" OD x 6.18" L
  - Light color: White, Housing Color: White/Black
- |      |        |       |            |      |       |     |         |
|------|--------|-------|------------|------|-------|-----|---------|
| Item | 700688 | Model | 560-2110-7 | Ship | 1 lbs | Net | \$24.99 |
|------|--------|-------|------------|------|-------|-----|---------|



#### LED PORTABLE BI-COLOR BOW NAVIGATION LIGHT

- Clamp-on mount • Dimensions: 2.53" OD x 6.18" L
  - Light color: Red/Green, Housing Color: White/Black
- |      |        |       |            |      |       |     |         |
|------|--------|-------|------------|------|-------|-----|---------|
| Item | 700689 | Model | 560-1111-7 | Ship | 1 lbs | Net | \$24.99 |
|------|--------|-------|------------|------|-------|-----|---------|



#### LED PORTABLE STERN NAVIGATION LIGHT

- 18" Pole with clamp-on mount
  - Dimensions: 2.53" OD x 6.18" L
  - Light color: White
- |      |        |       |            |      |       |     |         |
|------|--------|-------|------------|------|-------|-----|---------|
| Item | 700690 | Model | 560-2113-7 | Ship | 2 lbs | Net | \$34.99 |
|------|--------|-------|------------|------|-------|-----|---------|



#### LED PORTABLE STERN NAVIGATION LIGHT

- Inflatable boat mount • Dimensions: 2.53" OD x 6.18" L
  - Light color: Red/Green, Housing color: White/Black
- |      |        |       |            |      |       |     |         |
|------|--------|-------|------------|------|-------|-----|---------|
| Item | 700691 | Model | 560-1112-7 | Ship | 1 lbs | Net | \$24.99 |
|------|--------|-------|------------|------|-------|-----|---------|



#### LED PORTABLE STERN NAVIGATION LIGHT

- Inflatable boat mount • Dimensions: 2.53" OD x 6.18" L
  - Light color: White, Housing color: White/Black
- |      |        |       |            |      |       |     |         |
|------|--------|-------|------------|------|-------|-----|---------|
| Item | 700692 | Model | 560-2112-7 | Ship | 1 lbs | Net | \$24.99 |
|------|--------|-------|------------|------|-------|-----|---------|



## Solar Lights

### SOLLIGHT RAILLIGHT™ PREMIUM – Solar Powered LED Light

- Coated stainless steel – sturdy, lightweight and waterproof
- Charge outside during the day and use it inside at night
- Circular rail clamp that will clip onto any round rail 3/4" to 1-1/4"
- Larger transom clamp attaches horizontally or vertically (maximum 2")
- Small, weather-protected On / Off switch
- Lamp life: (8) hours on a full charge of sunshine

Item	Model	Description	Ship	Net
700367	3440	(4) LEDs provide 0.5 W	2 lbs	\$33.99



### SOLLIGHT RAILLIGHT MINI SOLAR LED LIGHT

- Easily attaches to any railing up to 1-1/4"
- Light sensor automatically turns on at dusk and off at dawn
- Stainless steel • 10-1/2" H x 2.5" W
- Lasts (8) hours of light on a full charge of sunshine

Item	Model	Description	Ship	Net
701316	3450	(2) White LEDs provide 0.3 W	1 lbs	\$25.99



## Davis Mega-Lights

- Light sensor automatically switches on at dusk and off at dawn
- Fresnel lens projects light for up to 2 NM
- Includes (2) bulbs: (1) for low current draw and (1) for extra brightness
- Low current bulb draws just 0.11 amps at 12 Volt DC
- Extra bright bulb draws 0.32 Amps

Item	Model	Description	Net
700000*	3300 Utility	Suspends from boom, awning or grab rail, with waterproof O-ring, sealed lens	\$39.99
700002	3310 Masthead	Mount to mast, interior/ exterior wall or bulkhead	42.99
701600	3330L	BA9S bayonet base bulbs (2) bulbs, (1) incandescent and (1) LED bulb	5.99



\*15' cord, cigarette lighter plug included (fits all standard lighter sockets)

## Searchlights

### ACR RCL-100D Remote Controlled Searchlight

Beam strength: 200,000 CP  
 Lens size: 4" x 2.75"  
 Rotation and speed: 360°; fast 28°/second, slow 15°/second

Elevation angle and speed: 9° up, 17° down  
 2°-7°/second Housing size: 8" x 9" x 8"

Housing material: White, marine grade aluminum (rugged, triple-primed and sealed); mounting hardware included

Control: Point Pad™ style joystick Bulb: (2) 55 W halogen

Bulb hours: 200 Power: 12-16 Volt DC Amps: 10 Warranty: 1 year

Item	Model	Description	Ship	Net
700809	1930.3	Includes Point Pad™ remote and master controller	13 lbs	\$1279.99
700384	1925	Light only	11 lbs	999.99



### ACR RCL-75 Remote Controlled Searchlight

Full travel, top to bottom, in 10 seconds.

Beam strength: 180,000 CP Lens size: 6" x 4.5"

Rotation and speed: 360°; 6-7° per second

Elevation angle 18° up, 45° down Elevation speed 6-7° per sec. (12 Volt DC) Housing: 8.75" H x 7.5" W x 7.5 D

Housing material: White, UV protected ASA; mounting hardware included Remote control: Point pad style joystick control

Bulb: (2) 55 W halogen; replacement bulb Product no. 9403

Bulb hours: 200 Amps: 10 Warranty: 1 year

Item	Model	Voltage	Ship	Net
700808	1946	12-14 Volt DC	7 lbs	\$269.99



### ACR RCL-100 LED Searchlight Kit

The ACR RCL-100 LED searchlight provides high intensity LED performance that pierces through dark nights and low lighting conditions. Beam strength: 220,000 CP

Rotation and speed: 360° continuous, Fast 31° per second, slow 20° per second Elevation angle: 9° up, 17° down

Elevation speed: 2.8° per second (12 VDC) Housing size: 8" H x 9 W x 8" D

Housing material: Die cast aluminum case is triple-primed and painted white with UV stabilizer

Remote control: Wired fingertip remote control Point Pad Bulb: High intensity LED

Bulb hours: 40,000 Amps: 3.0Amps @ 12Volts DC Warranty: 1 year

Bulb hours: 40,000 Amps: 3.0Amps @ 12Volts DC Warranty: 1 year

Bulb hours: 40,000 Amps: 3.0Amps @ 12Volts DC Warranty: 1 year

Bulb hours: 40,000 Amps: 3.0Amps @ 12Volts DC Warranty: 1 year

Bulb hours: 40,000 Amps: 3.0Amps @ 12Volts DC Warranty: 1 year

Bulb hours: 40,000 Amps: 3.0Amps @ 12Volts DC Warranty: 1 year

Bulb hours: 40,000 Amps: 3.0Amps @ 12Volts DC Warranty: 1 year

Bulb hours: 40,000 Amps: 3.0Amps @ 12Volts DC Warranty: 1 year

Bulb hours: 40,000 Amps: 3.0Amps @ 12Volts DC Warranty: 1 year

Bulb hours: 40,000 Amps: 3.0Amps @ 12Volts DC Warranty: 1 year

Bulb hours: 40,000 Amps: 3.0Amps @ 12Volts DC Warranty: 1 year

Bulb hours: 40,000 Amps: 3.0Amps @ 12Volts DC Warranty: 1 year

Bulb hours: 40,000 Amps: 3.0Amps @ 12Volts DC Warranty: 1 year

Bulb hours: 40,000 Amps: 3.0Amps @ 12Volts DC Warranty: 1 year

Bulb hours: 40,000 Amps: 3.0Amps @ 12Volts DC Warranty: 1 year

Bulb hours: 40,000 Amps: 3.0Amps @ 12Volts DC Warranty: 1 year

Bulb hours: 40,000 Amps: 3.0Amps @ 12Volts DC Warranty: 1 year

Bulb hours: 40,000 Amps: 3.0Amps @ 12Volts DC Warranty: 1 year

Bulb hours: 40,000 Amps: 3.0Amps @ 12Volts DC Warranty: 1 year

Bulb hours: 40,000 Amps: 3.0Amps @ 12Volts DC Warranty: 1 year

Bulb hours: 40,000 Amps: 3.0Amps @ 12Volts DC Warranty: 1 year

Bulb hours: 40,000 Amps: 3.0Amps @ 12Volts DC Warranty: 1 year

Bulb hours: 40,000 Amps: 3.0Amps @ 12Volts DC Warranty: 1 year

Bulb hours: 40,000 Amps: 3.0Amps @ 12Volts DC Warranty: 1 year

Bulb hours: 40,000 Amps: 3.0Amps @ 12Volts DC Warranty: 1 year

Bulb hours: 40,000 Amps: 3.0Amps @ 12Volts DC Warranty: 1 year

Bulb hours: 40,000 Amps: 3.0Amps @ 12Volts DC Warranty: 1 year

Bulb hours: 40,000 Amps: 3.0Amps @ 12Volts DC Warranty: 1 year

Bulb hours: 40,000 Amps: 3.0Amps @ 12Volts DC Warranty: 1 year

Bulb hours: 40,000 Amps: 3.0Amps @ 12Volts DC Warranty: 1 year

Bulb hours: 40,000 Amps: 3.0Amps @ 12Volts DC Warranty: 1 year

Bulb hours: 40,000 Amps: 3.0Amps @ 12Volts DC Warranty: 1 year

Bulb hours: 40,000 Amps: 3.0Amps @ 12Volts DC Warranty: 1 year

Bulb hours: 40,000 Amps: 3.0Amps @ 12Volts DC Warranty: 1 year

Bulb hours: 40,000 Amps: 3.0Amps @ 12Volts DC Warranty: 1 year

Bulb hours: 40,000 Amps: 3.0Amps @ 12Volts DC Warranty: 1 year

Bulb hours: 40,000 Amps: 3.0Amps @ 12Volts DC Warranty: 1 year

Bulb hours: 40,000 Amps: 3.0Amps @ 12Volts DC Warranty: 1 year

Bulb hours: 40,000 Amps: 3.0Amps @ 12Volts DC Warranty: 1 year

Bulb hours: 40,000 Amps: 3.0Amps @ 12Volts DC Warranty: 1 year

Bulb hours: 40,000 Amps: 3.0Amps @ 12Volts DC Warranty: 1 year

Bulb hours: 40,000 Amps: 3.0Amps @ 12Volts DC Warranty: 1 year

Bulb hours: 40,000 Amps: 3.0Amps @ 12Volts DC Warranty: 1 year

Bulb hours: 40,000 Amps: 3.0Amps @ 12Volts DC Warranty: 1 year

Bulb hours: 40,000 Amps: 3.0Amps @ 12Volts DC Warranty: 1 year



### Marinco 5" Remote Control Halogen Spot/Flood Light

The spot/flood kit includes a joystick control and 15' wiring cable with easy-to-install plug ends.

Beam strength: 72,000 CP beam / 30,000 CP flood light Lens size: 5" Rotation: 350° Elevation angle: 70°

Housing size: 4.5" W x 9.5" H x 7.5" L

Housing material: 316 stainless steel base, 304 stainless steel head Remote control: Wired dash mount

Bulb: Dual focus sealed beam

Bulb hours: 200 Amps: 7 Warranty: 1 year

Bulb hours: 200 Amps: 7 Warranty: 1 year

Bulb hours: 200 Amps: 7 Warranty: 1 year

Bulb hours: 200 Amps: 7 Warranty: 1 year

Bulb hours: 200 Amps: 7 Warranty: 1 year

Bulb hours: 200 Amps: 7 Warranty: 1 year

Bulb hours: 200 Amps: 7 Warranty: 1 year

Bulb hours: 200 Amps: 7 Warranty: 1 year

Bulb hours: 200 Amps: 7 Warranty: 1 year

Bulb hours: 200 Amps: 7 Warranty: 1 year

Bulb hours: 200 Amps: 7 Warranty: 1 year

Bulb hours: 200 Amps: 7 Warranty: 1 year

Bulb hours: 200 Amps: 7 Warranty: 1 year

Bulb hours: 200 Amps: 7 Warranty: 1 year

Bulb hours: 200 Amps: 7 Warranty: 1 year

Bulb hours: 200 Amps: 7 Warranty: 1 year

Bulb hours: 200 Amps: 7 Warranty: 1 year

Bulb hours: 200 Amps: 7 Warranty: 1 year

Bulb hours: 200 Amps: 7 Warranty: 1 year

Bulb hours: 200 Amps: 7 Warranty: 1 year

Bulb hours: 200 Amps: 7 Warranty: 1 year

Bulb hours: 200 Amps: 7 Warranty: 1 year

Bulb hours: 200 Amps: 7 Warranty: 1 year

Bulb hours: 200 Amps: 7 Warranty: 1 year

Bulb hours: 200 Amps: 7 Warranty: 1 year

Bulb hours: 200 Amps: 7 Warranty: 1 year

Bulb hours: 200 Amps: 7 Warranty: 1 year

Bulb hours: 200 Amps: 7 Warranty: 1 year

Bulb hours: 200 Amps: 7 Warranty: 1 year

Bulb hours: 200 Amps: 7 Warranty: 1 year

Bulb hours: 200 Amps: 7 Warranty: 1 year



### Golight Stryker LED Remote Control Searchlight

The Stryker LED remote control searchlight's streamlined design is enhanced with the efficiency, intensity and reliability of Golight's P-Vex LED optics package.

- Permanent stainless steel mounting plate system
- Peak beam intensity: 410,000 candelas
- Power: 12 Volt DC; Draw: 2.8 Amps
- Integrated 12 Volt DC high-torque motors
- Weatherproof for land and sea applications
- UV ray and salt water resistant
- 5-year limited warranty

Item	Model	Description	Finish	Ship	M.A.P.
701465	30004	Wireless remote	White	6 lbs	\$599.00
701466	30064	Wireless remote	Chrome	6 lbs	669.00
701467	30204	Wired dash remote	White	8 lbs	639.00
701468	30264	Wired dash remote	Chrome	8 lbs	699.00



### Golight® The Stryker™

Beam strength: 200,000 candelas

Lens size: 6" Rotation and speed: 370°, 2 speeds

Elevation angle: 135°

Housing size: 7.5" x 7" x 7.25" Base 6" x 6"

Housing material: ASA plastic

Bulb: Philips 9011 Amps: 5.5 Bulb hours: 270

hours minimum Power: 12 Volt DC

Warranty: 5 year limited

#### THE STRYKER WITH WIRELESS DASH-MOUNT AND HANDHELD REMOTE

Item	Model	Color	Volt	Ship	M.A.P.
700811	3067	White	12	5 lbs	\$379.00
700810	3066	Chrome	12	5 lbs	439.00

#### THE STRYKER WITH WIRELESS HANDHELD REMOTE (NO DASH-MOUNT)

Item	Model	Color	Volt	Ship	M.A.P.
700962	3000	White	12	5 lbs	\$319.00
701021	3006	Chrome	12	5 lbs	379.00



### Golight 2020 with Dash-Mount Control

Beam strength: 225,000 candelas Lens size: 6"

Rotation and speed: 370°, 1 speed (8 seconds)

Elevation angle: 135°

Housing size: 7" x 7" x 6.5" Housing material: ASA

Wired remote control: Dash-mount with quick connects, 20' harness

Bulb: Philips H-9 Amps: 5.5 Bulb hours: 270

Power: 12 Volt DC Warranty: 3 year limited warranty

Item	Model	Color	Volt	Ship	M.A.P.
700080	2020	White	12	5 lbs	\$199.00



### Golight RADIORAY® with Programmable Wireless Remote

Beam strength: 225,000 candelas Lens size: 6"

Rotation and speed: 370°: 2 speed (7/11 seconds)

Elevation angle and speed: 135°, 90° up, 45° down

Housing size: 7" x 7" x 6.5" Housing material: ASA

Remote control: Wireless remote Bulb: Philips H-9

Amps: 5.5 Bulb hours: 270 Power: 12 Volt DC Warranty: 3 year limited warranty

Item	Model	Color	Volt	Ship	M.A.P.
700081	2000	White	12	4 lbs	\$239.00



## Handheld Spotlights

### Dr. LED Star Phaser LED Search Light

- (3) state-of-the-art, 5 W, US made, high-power LEDs
- Durable rubberized head and hand grip
- Water-resistant, polycarbonate body
- Rechargeable NiMH and includes AC and DC chargers
- Two brightness settings: 1000 lumens/270 lumens
- High/Low/Strobe

Item	Model	Ship	Net
701097	8001030	2 lbs	\$92.99



### Hella LED Hand Held Search Light

- Rugged construction and a Corosafe coating system
- Ideal for Coast Guard, fishing vessels, sailing boats and all types of recreational and commercial vessels
- Multivolt™ technology ensures reliable illumination and lamp protection
- Light Output: 2500 lumens • Power Consumption: 30 Watt
- Spiral cable with cigarette lighter plug (extended length 3500 mm)
- Waterproof Protection: IP6K9K, IP6K8

Item	Model	Description	Ship	Net
701786	996476511	Long Range	3 lbs	\$234.99
	996476501	Close Range	3 lbs	234.99



### Aqua Signal Bremen LED Handheld Searchlight

- Black elastic rubber, shock resistant, non-corrosive, non-magnetic housing
- 12-24 Volt DC On/Off switch
- Morse code capability
- Built-in sealed beam
- Used by Coast Guard and military around the world
- 93 mA (12 Volt DC); 48 mA (24 Volt DC)

701714 Model 86600-7 Ship 2 lbs Net \$349.99

### Aqua Signal Bremen Portable Search Light

- The only SOLAS approved searchlight in the world
- Black elastic rubber housing, shock resistant, non-magnetic
- Waterproof rating: IP68
- Equipped with 10 ft. pigtail cable • 12 Volt DC/50 W halogen bulb included

701301 Model 80600-7 Ship 2 lbs Net \$177.99



### Aqua Signal LED Waterproof Rechargeable Spotlight

- Rechargeable battery
- Brightness: 350 lumens
- Run time: 6 hr (approx)
- Settings: High, Low, S.O.S and Red Rear Flashing alert

© Item 701763 Model 86700-7 Ship 2 lbs Net \$52.99





**Lumitec Razor Light Bar**

World's first flush mount light bar! Easy integration with most hardtop, arch, and pilothouse designs.

- 10,000 lumens
- White dimming
- 9 A @ 12 Volt DC / 4.2 A @ 24 Volt DC
- Dimensions: 18" W x 1.5" H x 3.5" D



**NEW!**

Item <b>701818</b>	Model <b>101586</b>	Flood	Ship 2 lbs	M.A.P. <b>\$649.00</b>
Item <b>701819</b>	Model <b>101587</b>	Spot	2 lbs	<b>649.00</b>

**Lumitec LED Flood Light**

- Compatible with 3rd party controllers, including Imtra, Cantaloupe, i2 and InterVolt
- Exclusive DeckSweep technology puts light where you need it
- Proudly designed and manufactured in the USA



**CAPRERA2 LED FLOOD LIGHT**

- Housing finish: White; fully sealed
- Dimensions: 4.49" W x 1.98" H x 2.58" D
- Power: 10 - 30 Volt DC; Draw: 1.3 A @ 12 Volt DC and 600 mA @ 24 Volt DC

Item	Model	Light Color	Ship	M.A.P.
<b>701404</b>	<b>101102</b>	Blue/White dimmable	1 lbs	<b>\$169.00</b>
<b>701642</b>	<b>101103</b>	Red/White dimmable	1 lbs	<b>169.00</b>

**CAPRERA LT LED FLOOD LIGHT - EXTERIOR**

- Housing finish: White; fully sealed
- Dimensions: 4.49" W x 1.98" H x 2.58" D
- Lumens (White): 1000
- Draw: 1.3 A @ 12 Volt DC and 600 mA @ 24 Volt DC

Item	Model	Light Color	Ship	M.A.P.
<b>701613</b>	<b>101292</b>	White; non-dimming	1 lbs	<b>\$99.00</b>



**Scandvik LED Spreader Light Bracket Mount**

The Stainless steel adjustable bracket allows flexibility in mounting options.

- UV resistant Zytel® composite housing
- 68 degree beam angle
- Working voltage: 8-30 Volt DC
- Color temp: 5500 k-6300 k



Item	Model	Dimensions	Ship	Net
<b>701746</b>	<b>41440</b>	4-1/2" L x 1-1/16" H x 1-3/4" D	1 lbs	<b>\$53.99</b>

**Scandvik Compact LED Spreader Light**

High quality composite housing will look good for years to come. Flush mount fasteners are hidden by bezel; easy cut-out for flush mount installation.

- (2) 5 W CREE 3535 LEDs
- Current draw: .7 Amp @ 12 Volt DC
- Cool White LED color: 5500 K - 6300 K



Item	Model	Dimensions	Ship	Net
<b>701593</b>	<b>41435</b>	Bracket 4-1/4" W x 2-5/8" H x 2-1/8" D	1 lbs	<b>\$62.99</b>
<b>701594</b>	<b>41436</b>	Flush 4-3/4" W x 2-3/4" H x 2" D	1 lbs	<b>59.99</b>

**Sea-Dog Halogen Flood Light**

- Injection molded fiberglass nylon housing with solid glass lens
- Stamped 304 stainless steel mounting bracket
- Halogen bulb



Item	Model	Bulb	VDC	Dimensions	Ship	Net
<b>701727</b>	<b>405110</b>	55W	12	6-15/16" L x 5-5/16" H x 3-3/16" D	2 lbs	<b>\$32.99</b>
	<b>405120</b>	70W	24	6-15/16" L x 5-5/16" H x 3-3/16" D	2 lbs	<b>37.99</b>
	<b>405115</b>	55W	12	5-7/8" L x 4-1/16" H x 3-3/16" D	1 lbs	<b>27.99</b>

**Sea-Dog Stainless Steel Spreader Light**

- Stamped 304 stainless steel housing
- 12 Volt DC; 35 W sealed beam bulb
- 4-5/8" diameter; 3000 CP
- Fasten with #10 RH



Item	Model	Description	Ship	Net
<b>700375</b>	<b>405210-3</b>	Adjustable (with ball joint), 4.5" D x 5.25" L	2 lbs	<b>\$62.99</b>
<b>700049</b>	<b>405220-3</b>	Fixed, 2.75" D x 6" L	1 lbs	<b>49.99</b>
<b>700050</b>	<b>405411</b>	Replacement bulb GE4411	1 lbs	<b>27.99</b>

**Sea-Dog LED Square Spot/Flood Light**

- 10 super bright LEDs
- Powder coated aluminum housing
- Dimensions: 3.5" W x 4.75" H x 2.75" D

**NEW!**



Item <b>701836</b>	Model <b>405340-3</b>	Ship 2 lbs	Net <b>\$145.99</b>
--------------------	-----------------------	------------	---------------------

**Sea-Dog Rectangular Flood Light**

- 6 super bright LEDs
- Powder coated aluminum housing
- Dimensions: 4.31" L x 4.13" H x 2" D

**NEW!**



Item <b>701835</b>	Model <b>405335-3</b>	Ship 1 lbs	Net <b>\$89.99</b>
--------------------	-----------------------	------------	--------------------

**Hella Halogen Deck Floodlight**

- White shockproof plastic reinforced housing
- Cable runs through rubber grommet for water protection
- With 12 Volt DC/55W HS bulb



**Hella Marine VALUEFIT 12-LED Light Bar with Flood Beam**

- (12) High performance LEDs
- Die-cast aluminum housing
- Coated aluminum bracket included
- Power consumption: 36 W



Item	Model	Description	Ship	Net
<b>701761</b>		12-LED light bar with flood beam	4 lbs	<b>\$114.99</b>

**Hella Marine VALUEFIT 6-LED Mini Light Bar with Flood Beam**

- (6) High performance LEDs
- Die-cast aluminum housing
- Dimensions: 6.3" W x 1.8" H x 2.5" D



Item	Description	Ship	Net
<b>701765</b>	12-LED light bar with flood beam	2 lbs	<b>\$44.99</b>

**Hella Sea Hawk-XLB LED Floodlights**

The new XLB floodlights generate over 2200 lumens of crisp, white light to illuminate the hardest to see places.

- High output LED in a sleek and versatile design
- Spread lamps illuminate a wide, close-range spread
- Spot lamps provide concentrated illumination
- Injection molded housing from thermally conductive ceramic polymer
- High output (2200 lumens/25 W) and low light (220 lumens/5 W) intensity functions in both spread and spot lamps

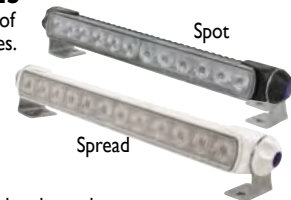

Item	Description	Specify Housing Color	Ship	Net
<b>701671</b>	Spread lens, 9-33 Volt DC	Black or White	2 lbs	<b>\$249.99</b>
<b>701672</b>	Spot lens, 9-33 Volt DC	Black or White	2 lbs	<b>249.99</b>

**Taco LED Spreader Light**

- (6) high-powered, 1-watt, shock resistant LEDs
- Draws 0.5 A
- 675 lumens light output
- UV and impact-resistant white housing and polycarbonate lens
- Includes clamp for standard 3/4" - 1" IPS T-top ring



Item	Model	Dimensions	Ship	Net
<b>701360</b>	<b>F38-4600WHA-1</b>	5" W x 3-7/16" H x 2-3/16" D	1 lbs	<b>\$53.99</b>

**Dr. LED Kevin X4 Spreader/Deck Light**

- Designed to be mounted up to 30' above deck
- Low current draw 1.5 A @ 12 Volt DC
- 1380+ lumens rated high-power LEDs
- ADC12 high purity die cast aluminum housing
- Dimensions: 6" W x 2" H x 2.6" D
- US Made CREE LEDs



Item	Model	Housing Color	M.A.P.
<b>701529</b>	<b>8001344-02</b>	White	<b>\$152.99</b>
<b>701622</b>	<b>8001993</b>	Black	<b>152.99</b>

**Dr. LED Gold Standard LED Spreader/Deck/Utility Light**

- Low profile (< 0.625")
- Marine grade finish
- (2) Wire installation
- Built-in dimming with any On/Off switch
- Provides ample heat sinking as well as ingress protection to ensure long life operation



Item	Model	Bulb	Ship	M.A.P.
<b>701532</b>	<b>9000500</b>	Bi-color, Red/White	1 lbs	<b>\$125.99</b>

**Dr. LED Low Profile Recessed LED Light**

- 800+ lumen rated
- Shock and vibration resistant
- Input Voltage: 10-30 Volt DC (1 A @ 12 Volt DC, 0.5 A @ 24 Volt DC)
- Dimensions: 5.9" W x 2.28" H x 1.59" D
- Cut-Out: 4.56" W x 1.77" H x 1.59" D
- Flush-mount or bracket-mount



Item	Model	Ship	M.A.P.
<b>701800</b>	<b>9000685</b>	2 lbs	<b>\$71.99</b>

## Underwater Lights

### LUMITEC SEABLAZE TYPHOON UNDERWATER LIGHT

Brighter, more advanced, more features. The evolution continues Typhoon sets a new standard for performance, reliability, and value in through-hull underwater lights. Typhoon delivers more than 10,000 measured lumens (White), and a modular quick-change design for easy in water service and upgrades. Offered in full color spectrum and White/Blue options.

- 10,000 lumens (White)
- Power: 10-30 Volt DC
- 10 A @ 12 Volt DC / 4.5 A @ 24 Volt DC
- Bronze housing
- 3" mounting hole
- Color rendering index 70+
- Rated Watts: 120

Item <b>701812</b>	Model <b>101448</b>	White/Blue	Ship 5 lbs	M.A.P. <b>\$1249.00</b>
Item <b>701813</b>	Model <b>101449</b>	Spectrum	5 lbs	<b>1499.00</b>



### LUMITEC SEABLAZE X SPECTRUM LED UNDERWATER LIGHT

The Lumitec SeaBlaze X LED underwater light has a nearly infinite number of color output options and user-selectable modes (switch sold separately)

- 3,000 lumens (White)
- Power: 10-30 Volt DC
- 5A @ 12 Volt DC / 2.5 A @ 24 Volt DC
- Surface mount
- Color rendering index 70+
- Rated Watts: 60
- Dimensions: 3.94" Diameter x 0.85" H x 0.85" D

Item <b>701645</b>	Model <b>101320</b>	Spectrum	Ship 2 lbs	M.A.P. <b>\$649.00</b>
--------------------	---------------------	----------	------------	------------------------



### LUMITEC SEABLAZE X LED UNDERWATER LIGHT

Twice the output of the SeaBlaze3 and completely surface mountable, the SeaBlazeX housing is bronze alloy with an underwater service life of more than 50 years.

- Bronze finish bezel
- Voltage: 10 - 30 Volt DC
- 12 Volt DC: 3.6 Amp (white strobe 5 Amp)
- 24 Volt DC: 1.7 Amp (white strobe 2.5 Amp)
- Correlated color temperature: 6500
- Dimensions: 3.94" Diameter x 0.75" H

Item	Model	LED Color	Functions	Ship	M.A.P.
<b>701420</b>	<b>101140</b>	White	Solid, fade, strobe	2 lbs	<b>\$399.00</b>
	<b>101141</b>	White/Blue	Cross fade / strobe	2 lbs	<b>399.00</b>
	<b>101143</b>	Green	Solid, fade, strobe	2 lbs	<b>399.00</b>
	<b>101142</b>	Blue	Solid, fade, strobe	2 lbs	<b>399.00</b>



### LUMITEC SEABLAZE3 LED UNDERWATER LIGHT

- Voltage: 10 - 30 Volt DC
- Power: White light: 2.5 Volt DC @ 12A, 1.1 A @ 24 Volt DC  
Colored light: 2.4 A @ 12 Volt DC, 1.1 A @ 24 Volt DC

- Correlated color temperature: 6500
- Color rendering index: 70+
- Rated Watts: 34
- Lumens (White) 1729
- Operating Temp: -31 to +131°F
- IP67 Compliant
- Certified Ignition Protected
- Dimensions: 3.9" Diameter x 0.79" H

Item	Model	LED Color	Ship	M.A.P.
<b>701582</b>	<b>101055</b>	White	2 lbs	<b>\$289.00</b>
	<b>101056</b>	Blue	2 lbs	<b>289.00</b>
	<b>101057</b>	Green	2 lbs	<b>289.00</b>
	<b>101058</b>	White/Blue	2 lbs	<b>289.00</b>



### LUMITEC SEABLAZE MINI SPECTRUM LED UNDERWATER LIGHT

Lumitec packs all of the features and dazzling output colors of the SeaBlazeX2 Spectrum into a powerful little package perfect for smaller trailer boats and skiffs. Surface mountable, no external drivers and nearly infinite output colors all with a simple 2 wire hookup!

- 3" Diameter • Anodized aluminum finish
- Draw: 880 mA @ 12 Volt DC, 450 mA @ 24 Volt DC
- Correlated color temp: 6500 • Color rendering index: 70+
- 0.5" Mounting hole diameter

Item	Model	Lumens	Voltage	Ship	M.A.P.
<b>701774</b>	<b>101436</b>	670	10-30 Volt DC	2 lbs	<b>\$199.00</b>



### DR. LED DAVE X3™ UNDERWATER LED LIGHT

- Shockproof, ultra-rugged with no filament to burn out or break
- Versatile surface mounted submersible (3) LED light
- Works above and below water line up to 10'
- Corrosion-proof, polycarbonate unibody
- Multi-voltage 12 Volt DC / 24 Volt DC / 12 Volt AC
- 500+ lumens
- Draw: ~0.3 A @ 12 Volt DC, ~0.15 A @ 24 Volt DC

Item	LED Color	Ship	M.A.P.
<b>701283</b>	White	1 lbs	<b>\$121.49</b>



### LUMITEC SEABLAZE X2 LED UNDERWATER LIGHT

Available in dual-color or full RGBW Spectrum output, SeaBlazeX2 delivers the exceptional performance quality and value of the industry-leading SeaBlazeX, with 60% greater output. The dual-color SeaBlazeX2 offers an internally synchronized white/blue cross fade mode, as well as white, blue and strobe output. The SeaBlazeX2 SPECTRUM delivers a nearly limitless palette of intense, rich, vivid colors and more than 6,000 integrating-sphere-measured lumens. SeaBlazeX2 is surface mounted, has no external drivers and has a pedigree of reliability recognized the world over. The bar has again been raised.

- Nearly infinite output color options and user-selectable modes
- Power: 10-30 Volt DC • Draw: 5 A @ 12 Volt DC or 2.5 A @ 24 Volt DC
- Correlated color temperature: 6500
- Color rendering index: 70+
- Dimensions: 3.94" W x 0.85" H x .5"
- Bezel Finish: Bronze
- Rated watts: 60
- 0.5" Mounting hole diameter

Item	Model	Lumens	LED Color	Ship	M.A.P.
<b>701792</b>	<b>101516</b>	6000 (White)	White/Blue	2 lbs	<b>\$389.00</b>
	<b>101515</b>	6000 (White)	Spectrum	2 lbs	<b>589.00</b>



### LUMITEC SEABLAZE QUATTRO LED UNDERWATER LIGHT

SeaBlaze Quattro boasts more than 2000 lumens, multi-mode output, including cross fade, and a marine grade bronze housing. Available in white/blue dual color or dazzling Spectrum output, SeaBlaze Quattro is the new standard for high-performance value in underwater lighting. And for those wanting to upgrade from the SeaBlaze3, the hole pattern on the new Quattro is exactly the same.

- Power: 10-30 Volt DC • Dimensions: 3.9" W x 0.71" D
- Draw: 2.1 A @ 12 Volt DC or 1.1 A @ 24 Volt DC
- 0.5" Mounting hole diameter • Surface mount for fast, easy installation
- Self-contained with no external driver boxes to mount

Item	Model	LED Color	Ship	M.A.P.
<b>701791</b>	<b>101511</b>	White/Blue	2 lbs	<b>\$279.00</b>
	<b>101510</b>	Spectrum	2 lbs	<b>349.00</b>



### LUMITEC ZAMBEZI QUATTRO SURFACE MOUNT UNDERWATER LIGHT

- Perfect match for larger pontoon boats, aluminum skiffs, and floating docks
- More than 2,000 lumens and stunning color

- Completely sealed with no external drivers
- Self-isolating from metallic mounting surfaces
- Perfect for typical transducer/accessory brackets
- Power: 10-30 Volt DC
- Draw: 2.1 A @ 12 Volt DC or 1.1 A @ 24 Volt DC
- Bulbs: LED / Non-dimming
- Diameter: 3.82" Diameter x 1.52" Deep"
- Bezel material: Bronze anodized aluminum
- Waterproof: IP68

Item	Model	LED Color	Ship	M.A.P.
<b>701790</b>	<b>101459</b>	Blue/White	2 lbs	<b>\$289.00</b>
	<b>101460</b>	Spectrum	2 lbs	<b>349.00</b>



### LUMITEC SEABLAZE MINI LED UNDERWATER LIGHTS (PAIR)

- Power: 10-30 Volt DC
- Draw: 450 mA @ 24 Volt DC and 990 mA at 12 Volt DC
- Actual MEASURED output of more than 890 lumens (White)
- Perfect for smaller trailer boats, skiffs or dinghies
- Dimensions: 2.98" W x .58" H
- 0.5" Mounting hole diameter
- Bezel material: Brushed hardcoat finish

Item	Model	LED Color	Ship	M.A.P.
<b>701511</b>	<b>101245</b>	White	2 lbs	<b>\$269.00</b>
	<b>101246</b>	Blue	2 lbs	<b>279.00</b>



### LUMITEC ZAMBEZI MINI SURFACE MOUNT UNDERWATER LIGHT

- Perfect for smaller pontoons and skiffs
- Mounting hole diameter: 1/4"
- Power: 10-30 Volt DC
- Lumens (White): 670
- Voltage: 10-30 Volt DC
- 12 Volt DC Amps: 880 mA; 24 Volt DC Amps: 450 mA
- Rated Watts: 10.5
- Depth: 1.2", Diameter: 3"
- Waterproof: IP68
- Bulbs: LED / Non-dimming
- Bezel material: Anodized aluminum

Item	Model	LED Color	Ship	M.A.P.
<b>701789</b>	<b>101456</b>	White	1 lbs	<b>\$149.00</b>
	<b>101457</b>	Blue	1 lbs	<b>149.00</b>
	<b>101458</b>	Spectrum	1 lbs	<b>199.00</b>



### SCANDVIK U-12 LED UNDERWATER LIGHT

- Brightest LED underwater light on the market in its class
- Thru-hull or standoff surface mount options
- 12 Volt DC • White: 414 Lumen output
- 5' Power cable and stainless steel screws included
- IP68 rating

Item	Description	Ship	Net
<b>701693</b>	12 bulb light, 0.2A draw	1 lbs	<b>\$25.99</b>





### INTRIA F-28 UTILITY LIGHT

- Designed for extreme water exposure and high shock loads/vibration
- 80° degree beam angle • 10-30 Volt DC • 7 W power consumption

Item	Type	Lumens	Specify Bulb Color	Ship	Net
701549	Int./Ext.	510-600	Cool or Warm White	1 lbs	\$107.99
701551	Ext.	510-600	Cool or Warm White	1 lbs	125.99



### INTRIA INTERIOR/EXTERIOR HIGH OUTPUT LINEAR LED - TOUCH SENSOR SWITCH

- Surface mount, 10.63" L x 1.57" W x 0.31" D • IP 67 Protection
- 117° beam angle • 10-30 Volt DC • 8 W power consumption

Item	Model	Bulb Color	Ship	Net
701548	IL7367	Cool White / Blue LED	1 lbs	\$134.99
	IL7366	Cool White / Red LED	1 lbs	134.99
	IL7354	Warm White / Blue LED	1 lbs	134.99
	IL7353	Warm White / Red LED	1 lbs	134.99



### HELLA DURALED 50 LOW PROFILE LIGHT

- Multivolt™ 9-33 Volt DC; less than 12 W • 8.74" L x 3.78" W x .98" D
- Waterproof IP 67 rating, completely sealed • CE, ISO 8846 Ignition protection approved

Item	Model	Light Pattern	Ship	Net
701744	980629001	Spread - 36 deg.	1 lbs	\$199.99
	980629501	Wide spread - 66 deg.	1 lbs	199.99



### AQUA SIGNAL LONDON LED ENGINE ROOM LIGHT

- LED light color: Cool White, Bezel finish: White
- Select input voltage and draw
- Mount: surface, Dimensions: 6-1/2" x 3-1/2" (switch not included)

Item	VDC	Ship	Net
701776	12 or 24	1 lbs	\$77.99



### BALMAR MULTI-LITE

- Can be used on decks, passages, engine rooms or showers
- Corrosion resistant and watertight • Not for gasoline fumed areas
- Fresnel lens with "O"-ring seal and protective lens guard
- Uses standard medium base bulbs in 12-24-32 Volt DC and 115-230 Volt AC from 15 W to 40 W • Uses medium base standard household bulb (not included)

Item	Model	Description	Dimensions	Ship	Net
700775	458-S	With built-in switch	6.875" x 4.65" x 4.5"	2 lbs	\$52.99
700776	458	Hard wired version	6.875" x 4.65" x 4.5"	2 lbs	48.99



### LUMITEC NEVIS LED ENGINE ROOM LIGHT

- Perfect for engine rooms, wet locations or mechanical spaces
- Small, durable, extremely powerful light source • Completely sealed, IP67 compliant • Recognized by the USCG as ignition protected • Douses hard-to-light-areas with a spread of bright, even light • Bezel finish: brushed • Power: 10-30 Volt DC
- Draw: 900 mA @ 12 VDC or 450 mA @ 24 VDC • Dimensions: 5" L x 2.50" W x 0.63" H

Item	Model	Light Color	Ship	M.A.P.
701413	101070	White dimming	1 lbs	\$159.00
701691	101148	White dimming/Red dimming	1 lbs	169.00
	101147	White dimming/Blue dimming	1 lbs	169.00



### SCANDVIK LED BUNK/CABIN LIGHT

- Input voltage: 12 / 24 Volt DC, Power consumption: 8 watts
- Mount: surface, Dimensions: 13" L x 2-3/4" W x 7/8" H

Item	Model	Light Color	Ship	Net
701758	41364	Warm White	1 lbs	\$69.99



### SCANDVIK LED ENGINE ROOM LIGHTS

- For engine rooms, wet locations or mechanical spaces
- Waterproof IP65 rating • Beam angle: 180°
- Surface mount (hardware included) • Wire can exit from bottom or end of fixture
- USCG, ABYC, NMMA and SAE J1171 certified ignition protection

Model 41388 Power: 12 Volt DC; Draw: 1.5 A @ 12 Volt DC  
 Model 41389 Power: 10-30 Volt DC; Draw: 2.1 A @ 12 Volt DC or 1 A @ 24 Volt DC

Item	Model	Lumens	Dimensions	Light Color	Ship	Net
701521	41388	1154	13" L x 2-3/4" W x 1" H	Cool White	1 lbs	\$74.99
701522	41389	1520	13" L x 2-3/4" W x 1" H	Cool White	1 lbs	104.99



### SCANDVIK E-330 LED COMPACT ENGINE ROOM/UTILITY LIGHT

- Cool white LED with White bezel finish
- Surface mount • 6-3/8" x 3-3/4" x 5/8" • IP67
- 727 lumens • 10 Watts consumption • Switch not included
- USCG, ABYC, NMMA, SAE, J1171 certified
- Wire can exit from side of fixture

Item	Model	VDC	Ship	Net
701696	41590	10-30	1 lbs	\$49.99



### SCANDVIK SCAN-STRIP

#### 4-COLOR LED STRIP LIGHT

- Simple 2-wire connection • Power: 12/24 Volt DC (10-30 Volt DC)
- 7/8" W x 1/2" H • Warranty: 1 Year

- LED Colors: Red, Green, Blue, Daylight White (5500-6300K)
- Specify Length: 8" (94 lumens), 16" (180 lumens) or 20" (234 lumens)

Item	Model	VDC	Ship	Net
701793			1 lbs	Starting at \$27.99



### AQUA SIGNAL MAPUTO LED LIGHT

- Multi-purpose interior light • 2 wire lead controls light
- Material: White plastic housing with polycarbonate lens • Mount: Surface, (4) screws (not included) • Light source: LED • Operating voltage: 12/24 Volt DC
- Energy draw: < 0.4 A @ 12 Volt DC • Dimensions: 15-3/4" x 3 1/8" x 1"

Item	Model	Light Color/Switch	Ship	Net
701036	16530-7	Red and White (White/Off/Red)	1 lbs	\$69.99
701235	16533-7	Blue and White (White/Off/Blue)	1 lbs	69.99
701200	16531-7	White (On/Off/On-bright)	1 lbs	69.99



### AQUA SIGNAL MALABO MULTI-PURPOSE LED INTERIOR LIGHT

- Surface mount
- Low profile; Only 5/8" high
- Power: 12 Volt DC / 24 Volt DC, Draw: 0.36 A @ 12 Volt DC • # of LEDs: (12)
- Light output: 130 lumens • Dimensions 15.25" L x 2.75" W x 0.875" D
- Housing - Aluminum and White plastic
- Includes illuminated switch for easy switching in dark areas

Item	Model	Light Color	Ship	Net
701572	16541-7	Warm White	1 lbs	\$42.99



### AQUA SIGNAL ARUBA LED LINEAR LIGHT - INTERIOR

- 12 Volt DC • Dimensions 0.91" W x 0.5" H x Select length
- Housing: Black • Light Color: Cool White

Item	Model	Length	Ship	Net
701764	16720-7	6"	1 lbs	\$11.99
	16721-7	12"	1 lbs	16.99
	16722-7	18"	1 lbs	22.99



### AQUA SIGNAL BELLO LED COURTESY / ACCENT LIGHT

- Suitable for accent lighting on the deck, in cabins, lockers or in the bilge • Draws 90% less power compared to incandescent lights • Amp draw: 0.4 A • LEDs create very little heat, making them ideal for multiple applications
- Power: 12 Volt DC • Contains (6) LEDs • Completely waterproof
- Dimensions: 4" L x 3/4" W x 1" D • Requires (2) mounting screws (not included)

Item	Model	Ship	Net
701238		1 lbs	\$20.99



### Lumitec Rail2 Lighting

- RAIL2 - 11.72"L
- Mini RAIL2 - 5.89"L

- Attractive design mounts to flat or curved surfaces (e.g., T-tops or grab rails)
- Certified intrinsically safe / ignition protected - perfect for engine rooms
- Bright, even light outperforms fluorescents at one-third the power and one-fifth the size
- Sealed for long life and extreme durability - IP67 compliant

### MINI RAIL2 • 10 to 30 Volt DC • 360 mA @ 12 Volt DC

Item	Bulb Color	Ship	Net
701411	Specify White, Blue, or Red	1 lbs	\$39.95
701514	Warm White	1 lbs	39.95

### RAIL2 • 10 to 30 Volt DC • 920 mA @ 12 Volt DC

Item	Model	Bulb Color	Ship	M.A.P.
701515	101242	Warm White	1 lbs	\$99.00
701516	101243	Warm White, Blue, Red	1 lbs	99.00
701811	101283	Spectrum Full Color RGBW	1 lbs	124.00



### Hella Surface Strip Lamps with Switch

- UV resistant enhance impact acrylic
- Less than 3W • 11.14" L x 1" W x .43" D
- Surface mount • Completely sealed IP 67 protection

#### WHITE LED - 5000K

Item	Model	Bulb Color	VDC	Ship	Net
701743	958121001	Red/White	12	1 lbs	\$69.99
	958123001	White	12	1 lbs	63.99

#### WARM WHITE - 2700K

Item	Model	Bulb Color	VDC	Ship	Net
701743	958121101	Red/Warm White	12	1 lbs	\$69.99
	958123101	Warm White	12	1 lbs	63.99



### SEA-DOG LED MOTION ACTIVATED LIGHT

- Gray injection molded nylon • Easily mounted to any enclosed area using the provided two-sided tape • Two center bulbs have a 60° beam angle and the two outside bulbs have a 120° beam angle
- (3) AAA batteries included • (4) Super bright LED's
- Surface mount; 6-7/8" L x 1-5/16" W x 3/4" H

Item	Model	Ship	Net
701690		1 lbs	\$19.99



### DR. LED JOHN UNDER-CABINET LED LIGHT

- General purpose; surface-mount; daisy chain cable included
- Dual level White light or Red/White combo • 8" L x 2.5" W x 1.36" D

Please specify bulb color: Red/White or White/White

Item	VDC	Ship	M.A.P.
701121	Multi-voltage 12/24	1 lbs	\$62.99



## Accent & Courtesy Lights

### LUMITEC IBIZA ENGINE ROOM LIGHT

- Bright, reliable, easy to install
- Completely sealed
- Compatible with most PWM LED dimmers
- 1000 lumens
- Operating voltage 10-30 Volt DC
- 1.3A @ 12 Volt DC / 600 mA @ 24 Volt DC



Item	Model	Light Color	Ship	M.A.P.
701814	101521	Red/White	1 lbs	\$159.00
701815	101522	Blue/White	1 lbs	159.00

### LUMITEC ANDROS ACCENT / COURTESY LIGHT

- For indoor or outdoor use
- Rating: IP67 waterproof
- Power: 10 - 16 Volt DC
- Draw: 45 mA @ 12 Volt DC
- Size: 1" W x 1" H x 1/2" depth
- Bezel finish: Polished stainless steel
- Specify light color: White, Red or Blue



Item	Ship	Net
701649	1 lbs	\$19.95

### LUMITEC NEWT LED LIVEWELL & COURTESY LIGHT

- For use under cabinets, storage lockers, toe kicks and overhead
- For wet or dry use
- Finish: polycarbonate
- Power: 10 - 16 Volt DC
- Lumens (White): 45
- Draw: 45 mA @ 12 Volt DC
- Ignition protected
- OD .88"; depth .78", cutout diameter .55"
- Completely sealed and IP67 compliant (silicone gasket included)



Item	Model	Light Color	Ship	Net
701414	101084	White, non-dimming	1 lbs	\$14.95
701584	101085	Blue, non-dimming	1 lbs	14.95

### AQUA SIGNAL LIMA - LIVEWELL BULKHEAD ACCENT LIGHT

- Light output same as 12 Volt DC incandescent bulb
- Completely sealed for livewells
- Low heat makes them safer for enclosed areas
- Please specify LED color: White, Red or Blue



Item	Description	Ship	Net
701008	Single LED with 0.3 W draw	1 lbs	\$12.99

### AQUA SIGNAL LED COURTESY / ACCENT LIGHT

- High grade stainless steel cover with mounting screws
- Sealed for water, corrosion and vibration resistance
- Specially designed lens directs light downward
- 3/4" diameter round cutout
- Power: 12 Volt DC



Please specify Warm White or Blue light

Item	Dimensions	Ship	Net
701709	3" x 1-1/4"	1 lbs	\$14.99

### AQUA SIGNAL LED BOGOTA & SANTIAGO ACCENT LIGHTS

- Same output as a 12 Volt DC incandescent 5 W bulb
- Perfect for bulkhead, steps, walkways, etc.
- Safe; low heat; low amp draw - 0.1 A
- Please specify Red, White or Blue light



Item	LEDs	Description	Ship	Net
701004	4	Round, White cover	1 lbs	\$22.99
701005	4	Round, Stainless steel cover	1 lbs	25.99
701006	3	Oblong, no cover	1 lbs	14.99
701007	3	Oblong, Stainless steel cover	1 lbs	17.99

### AQUA SIGNAL FLEXIBLE LED STRIP LIGHT

- Sealed and waterproof
- For interior or exterior applications
- Includes optional mounting track for linear mounting
- Mounting track and strip light includes:
- 3M double sided adhesive tape
- 10" supplied wiring
- Optional end caps for additional mounting security using supplied mounting screws
- Width: 3/8"



Item	Model	Length	Light Color	Draw	Ship	Net
701710	16701-7	6"	Blue	12 mA	1 lbs	\$12.99
	16700-7	6"	Cool White	6 mA	1 lbs	12.99
	16703-7	12"	Blue	12 mA	1 lbs	16.99
	16702-7	12"	Cool White	12 mA	1 lbs	16.99
	16705-7	18"	Blue	18 mA	1 lbs	25.99
	16704-7	18"	Cool White	18 mA	1 lbs	25.99

**M.A.P.** Some manufacturers set M.A.P. (Minimum Advertised Pricing) for their products, so we cannot advertise a lower price. However, this does not always apply to selling price. The actual price you will be charged is probably lower. Please call us at 800-628-8225 for further details.

### HELLA SURFACE MOUNT OBLONG LED COURTESY LAMP

- 316 Polished stainless steel rim
- Dimensions: 3.31" x 1.14"
- IP 67 - Completely sealed
- Approvals: CE, RCM
- Pre-wired with 120 mm of twin core marine cable
- Power consumption: 0.5 W (< 0.04 A @ 12 Volt DC / < 0.02 A @ 24 Volt DC)



Please specify light color: Blue, Red, White, Warm White

Item	Description	Ship	Starting at
701673	12/24 Volt DC	1 lbs	\$27.99

### HELLA EASY FIT MULTIVOLT™ LED COURTESY LAMP

- For interior and exterior lighting applications
- Completely sealed, shock and vibration resistant
- 30° light down angle
- Material: UV and impact resistant plastic
- Installation: Prewired with 120 mm of cable
- Mount: Single hole (cutout: 1.00" diameter x .55" deep); foam gasket included
- Light source: LED
- Operating voltage: Multivolt™ 12-24 Volt DC
- Power consumption: 0.5 W
- Overall dimensions: 1.77" L x 1.24" W
- Specify cap finish: Chrome, White or Gold



Item	Model	LED Color	Cap Finish	Ship	Net
700956	998560001	White	Chrome	1 lbs	\$19.99
	998560011	White	White	1 lbs	19.99
701250	998560041	Blue	Chrome	1 lbs	19.99

### I2SYSTEMS EMBER LED MINIATURE STEP LIGHT - OVAL - EXTERIOR

- Small marine-grade LED courtesy light
- Unique asymmetric beam angle ideal for illuminating steps, hallways and other low-level surfaces
- Down-angled beam with washboard eliminates glare while wide beam profile provides even illumination across step and path surfaces
- IP 67 waterproof rated
- Lens Material: Polycarbonate
- Beam Angle: Asymmetric
- Bezel Finish: Specify polished chrome or polished gold
- Dimensions: 2.30" x 1.80"
- Mount: Recessed, snap mount
- Cutout: 1.25" dia.
- Recessed Depth: 0.85"
- Operating Voltage: 9 - 30 Volt DC / 9 - 15 Volt AC
- Power Consumption: 1.5 Watts typ., 2.5 Watts max.



Item	Model	LED Color	Ship	M.A.P.
700564	E1150Z-13E	Blue	1 lbs	\$45.00
	E1150Z-13AAH	Cool White	1 lbs	45.00
	E1150Z-13CAB	Warm White	1 lbs	45.00

### SEA-DOG LED STRIP LIGHT

- 6 or 12 low amp draw LEDs per light
- Epoxy potted circuit board
- Voltage 12/24 Volt DC
- Corrosion resistant lightweight plastic



### SEA-DOG FLUSH MOUNT ROUND COURTESY LIGHT

- Stainless steel cover keeps the light from projecting upwards.
- 1-1/2" diameter x 1-1/4" L • Fits 1-1/8" diameter hole



### SEA-DOG FLUSH MOUNT OVAL COURTESY LIGHT

- Stainless steel cover keeps the light from projecting upwards.
- 2-1/2" W x 1-1/4" H x 1-1/4" L • Fits 1-1/8" diameter hole



Item	Light Color	Ship	Net
701715	Specify White or Blue	1 lbs	\$14.99

### SEA-DOG DELUXE LED COURTESY LIGHT - LARGE

- Modern and streamlined profile. • Three LEDs draw little amperage and have a long life. • Voltage: 9-28
- 3-15/16" L x 1 1/16" T x 7/16" D • Waterproof IP67
- Cast 316 Stainless steel exterior



Item	Specify Light Direction	Specify Light Color	Ship	Net
701717	Forward or Down	White or Blue	1 lbs	\$26.99

### SEA-DOG DELUXE LED COURTESY LIGHT - SMALL

- Modern and streamlined profile. • Three LEDs draw little amperage and have a long life. • Voltage: 9-28
- 2-3/4" L x 1 1/16" T x 3/8" D • Waterproof IP67
- 304 stamped stainless steel exterior



Item	Specify Light Direction	Specify Light Color	Ship	Starting at
701718	Forward or down	White or Blue	1 lbs	\$20.99



## LED Interior/Exterior Lights

### IMTRA SIGMA POWERLED LIGHTS

The ultimate LED refit lighting series seamlessly replaces power-hungry 20W halogen down lights with no extra wires and no modification to the boat's ceiling or headliner.

- Dimmable with existing 2-wire boat cable
- Compatible with some existing low voltage halogen dimmers
- Flexible mounting options
- 10 - 40 VAC / DC input voltage (from battery or magnetic transformer)

**Dimensions:** Small recessed: Cutout diameter: 2.56" Depth: .90" Flange diameter: 3.57" Large recessed: Cutout diameter: 2.56"-3.42" Depth: .90" Flange diameter: 4.35"  
**Surface mount:** Base diameter: 4.07", Height: 1.25"



Recessed

Item	Description	Specify Housing	Specify Light Color	Ship	Net
701544	Small recessed	Stainless	Warm or Cool White	1 lbs	\$143.99
701545	Surface mount	Stainless	Warm or Cool White	1 lbs	166.99
701546	Large recessed	Stainless or Brushed	Warm or Cool White	1 lbs	162.99

### LUMITEC ORBIT LED DOWN LIGHT

- Power: 10-30 VDC
- Dimensions: 2" diameter x .75" deep x 1.25" cutout
- Recessed Depth: 0.43"
- Fully sealed and IP67 compliant
- Non-dimming



**Specify bezel finish:** White aluminum or brushed aluminum

Item	Color	Output	Draw	Ship	M.A.P.
701406	White, Blue, Red, Purple	290mA @12VDC or 160mA @24VDC	1 lbs	\$98.00	
701407	White	360mA @12VDC or 180mA @24VDC	1 lbs	49.95	
701821	White, Blue, Red	360mA @12VDC or 180mA @24VDC	1 lbs	98.00	

### LUMITEC AURORA LED DOME LIGHT

- IP67 immersion protection
- Bezel finish: Stainless steel
- Power: 10-30 VDC
- Dimensions: 4" Dia. x 0.73" H
- Draw: 345mA @12 VDC or 210mA @ 24 VDC

**Bezel finish:** Stainless steel **Light Color:** White

Item	Model	Ship	M.A.P.
701417	101137	1 lbs	\$99.00

**Bezel finish:** Stainless steel

**Specify:** White/Blue dimming or White/Red dimming

701418	1 lbs	109.00
--------	-------	--------

**Bezel finish:** White **Light color:** White, Blue dimming

701641	101075	1 lbs	99.00
--------	--------	-------	-------

**Bezel finish:** White **Light color:** White, Red dimming

701583	101076	1 lbs	99.00
--------	--------	-------	-------



### HELLA EUROLED 150 FLUSH MOUNT TOUCH LAMP

- Interior/exterior
- Power: 9-33 VDC
- Touch sensitive switching and dimming
- Power consumption: 4.0W 0.33A @12V, 0.16A @24V
- Protective system: completely sealed
- Dimensions: 5.9" dia. x .79" depth (cutout: 4.88")



Item	Bezel	Light Color	Ship	Net
701318	White plastic	Warm White/Red	1 lbs	\$145.99
701319	Stainless steel	Warm White/Red	1 lbs	155.99

### HELLA EUROLED 75 LED DOWN LIGHT - SCREW MOUNT

- Interior/exterior
- Completely sealed
- 190 lumens
- Wide, even illumination reducing individual light source glare
- Dimming via PWM or voltage resistive dimmer
- Pre-wired and sized for a standard cut out
- Power consumption: < 3 watts <0.19 A @12V, <0.1 A @24V
- Dimensions: 2.83" dia. (stainless rim) or 2.95" dia. (plastic rim) .29" depth (cutout: .63")



Item	Model	VDC	Bezel	Light Color	Ship	Net
701747	958109021	12	Stainless steel	Warm White	1 lbs	\$48.99
	958109011	12	White	Warm White	1 lbs	41.99
	958110021	12	Stainless steel	White	1 lbs	48.99
	958110011	12	White	White	1 lbs	41.99

### HELLA EUROLED 75 LED DOWN LIGHT - SPRING MOUNT

- Interior/exterior
- Completely sealed
- 190 lumens
- Wide, even illumination reducing individual light source glare.
- Dimming via PWM or voltage resistive dimmer
- Pre-wired and sized for a standard cutout
- Power consumption: < 3 watts <0.19 A @12V, <0.1 A @24V
- Dimensions: 2.83" dia. (stainless rim) or 2.95" dia. (plastic rim) .29" depth (cutout: .81")
- **Please specify:** White or Stainless steel bezel and White or Warm White bulb.



Item	Model	VDC	Bezel	Light Color	Ship	Net
701748	958109521	12	Stainless steel	Warm White	1 lbs	\$49.99
	958109511	12	White	Warm White	1 lbs	42.99
	958110521	12	Stainless steel	White	1 lbs	49.99
	958110511	12	White	White	1 lbs	42.99
	958109621	24	Stainless steel	Warm White	1 lbs	49.99
	958109611	24	White	White	1 lbs	42.99

### AQUA SIGNAL VIENNA LED LIGHT

- LED multi-purpose lights
- Plastic with acrylic clear lens
- Built-in push lens as On/Off switch
- Surface or recess mount requires 2 screws (included)
- Size: 5" x 3" x 1"
- 6 W



Item	Model	Housing/Light	VDC	Ship	Net
701077	16610-7	White plastic/Cool White	12	1 lbs	\$24.99

### LUMITEC MIRAGE DOWN LIGHT

- 172 Lumens
- White housing / White light
- Power 10-30VDC
- 360mA @12VDC / 180mA@24VDC
- Ultra slim profile
- 3.25" diameter



Ship 1 lbs

M.A.P. \$49.95

### SEA-DOG LOW PROFILE TASK LIGHT

- Surface mount
- Corrosion-resistant 304 stainless steel
- Integrated touch control for on/dim/off operation
- Activated by pressing center button
- Memory function turns light back on at same brightness level as when it was turned off
- Power: 12-28 Volt DC
- CE approved
- 24 LEDs
- Draw: 0.19 Amp
- Waterproof rating: IP65



Outside diameter: 2-3/4" x 5/16" High

Item	Model	Diameter	LED Color	Brightness	Ship	Net
701826	401686-1	2-3/4"	Warm White	145 lumens	1 lbs	\$47.99

### SEA-DOG DELUXE HIGH POWER LED OVERHEAD LIGHT ADJUSTABLE ANGLE

- Excellent LED light dispersion and brightness
- Ideal for cabins, walkways, interior compartments and cockpit lighting.
- Spring mounted
- Voltage: 12-28
- 2-5/8" diameter
- Fits 1-13/16" diameter hole x 1-1/16" deep

Item	Model	Ship	Net
701721	404520-1	1 lbs	\$59.99



### IMTRA GIBRALTAR BI-COLOR POWERED DOWNLIGHT WITH 3-WAY SWITCH - EXTERIOR

- Surface-mount dome light styled in the classic tradition
- Full-brightness white LED with additional low-level "Red" secondary color
- Integral 3-way toggle allows for on/off or bi-color switching
- Beam Angle: 84° (white)
- Bezel: Stainless steel (finish: polished stainless steel)
- Lens: Frosted glass
- Operating Voltage: 10 - 30 Volt DC
- Power Consumption: 4.7 Watts
- IP 55 Protected against dust / protected against jets of water from all directions



### IMTRA LARGO TRI-COLOR POWERED WITH DIMMER - EXTERIOR

- Features a single, two-wire fixture with (3) color outputs
- Built-in momentary push-button switch controls on/off functions, LED color selection and dimming
- Install location: Ceiling or bulkheads, wet or dry ingress
- Protection: IP65 Class F, III
- Input voltage: 10-30 Volt DC
- Halogen equivalency: 30 Watt
- Power consumption: 5.0 Watt
- Beam angle: 96°
- Lifetime hours: 50,000
- Dimmer control interface: Integrated push-button
- Dimming range: 20-100% (all three colors)
- Brightness: 292 lumens (White), 24 lumens (Red), 22 lumens (Blue)
- Dimensions: 6.00" base x 1.50" height, 3.99" lens dia.
- 5 year warranty



Item	Model	LED Color	Ship	Net
701701	ILIM32800	Red / Blue / Warm White	1 lbs	\$197.99

### I2SYSTEMS APEIRON LED TRI-LIGHT - EXTERIOR

- Applications include hardtop, arch, cockpit, courtesy and pilot house installations
- Rugged stainless steel construction
- Lens material: Tempered glass with diffuser
- Beam angle: 120°
- Dimensions: 3.50" dia.
- Cutout: 2.59" dia.
- Recessed depth: 1.07"
- Mount: Recessed, screw mount
- Operating voltage: 9 - 30 Volt DC
- Power consumption: 1.5 Watts
- Ingress protection: IP 67 (Dustproof / protected against temporary immersion to depth of 1 m)



Item	Model	Bezel Finish	LED Color	Ship	M.A.P.
700566	A3120Z-11HAE	Chrome	Cool White/Red/Blue	1 lbs	\$85.00
	A3120Z-31HAE	Powder Coated White	Cool White/Red/Blue	1 lbs	85.00
	A3120Z-11HCE	Chrome	Warm White/Red/Blue	1 lbs	85.00
	A3120Z-41HCE	Nickel	Warm White/Red/Blue	1 lbs	85.00
	A3120Z-51HCE	Off White	Warm White/Red/Blue	1 lbs	85.00

**LED Interior/Exterior Lights, Accent/Courtesy/Dome**

**DR. LED MARS DOME™ CABIN LIGHT**

**USED BY THE USAF**

An LED surface mount dome light with 3-position switch (High/Off/Low) **Two options available** - either 2 levels of Warm White light or Warm White/Red. Equivalent to about a 40 W bulb. US made CREE LEDs. Shockproof construction. **Material:** Chrome plated plastic **Installation:** Polarized 4" pigtail cable **Mount:** Surface **Input voltage:** 12/24 VDC **Draw:** Very low power consumption, approximately 1 to 5 watts depending on the selection.



**Light output:** 250 lumens **Lens Material:** Polycarbonate

Item	Model	Description	Size	Ship	M.A.P.
700536	8001177	2-level Warm White light	5-1/2"	1 lbs	\$62.99
700537	8001184	White and Red light	5-1/2"	1 lbs	62.99
700538	8001528	2-level Warm White light	6 - 3/4"	1 lbs	70.19
700539	8001504	White and Red light	6 - 3/4"	1 lbs	71.09

**DR. LED MARS DOME LIGHT WITH SWITCH**

- General purpose, surface-mount bi-color LED light for night use
- Three-position switch (Red / Off / Warm White) to select Red or Warm White light
- Long service life: shockproof and ultra-rugged with no filament to break or burn out
- Lead and mercury-free with no UV output
- US made CREE LEDs



**Material:** Brass colored ABS plastic **Installation:** Polarized 4" pigtail cable **Mount:** Surface **Input voltage:** 10-30 Volt DC **Draw:** 2 (red) / 5 Watts (White) @ 12/24 Volt DC **Light output:** 250 Lumens (Warm White) / 40 Lumens (Red)

**Lens material:** Polycarbonate

Item	Model	Size	Ship	M.A.P.
701620	8001498	5-1/2" Dia. x 1-5/8" H	1 lbs	\$67.21
701621	8001511	6-3/4" Dia. x 1-5/8" H	1 lbs	76.81

**SEA-DOG INTERIOR LED DOME LIGHT WITH SWITCH**

- Side-mounted On/Off toggle switch
- Illuminated by (18) White LEDs
- Output comparable to 15 Watt halogen
- Light gives off very low heat
- Resistant to vibration
- Extremely long service life
- Mount: Surface
- Operating voltage: 12 Volt DC
- Power consumption: < 1 Watt @ 12 Volt DC
- Current draw: 68 mA @ 12 Volt DC



Item	Model	Size	Bezel	Ship	Net
701601	400203-1	6-3/4" Dia. x 2-1/8"H	Stamped 304 stainless steel	1 lbs	\$49.99
701602	400198-1	5-1/2" Dia. x 1-13/16"H	Stamped polished brass	1 lbs	49.99
701603	400208-1	6-3/4" Dia. x 2-1/16"H	Stamped polished brass	1 lbs	59.99

**SEA-DOG LED DAY/NIGHT DOME LIGHT**

- Gives off very low heat and is resistant to vibration
- Includes On/Off light switch
- Power: 12 Volt DC
- Draw: .068 A



**Please specify bezel finish:** White plastic or chromed plastic

Item	Diameter	LED Lights	Ship	Starting at
701354	5-3/4"	(15) White, (5) Red	1 lbs	\$29.99
701355	5-3/4"	(18) White	1 lbs	29.99

**SEA-DOG DOME LIGHT • 18.4 W DOUBLE BAYONET BULB**

- Solid teak base with lacquer-coated brass trim ring
- Pre-wired with an On/Off switch
- Power: 12 Volt DC
- Bulb: 18.4 W Incandescent double bayonet
- Solid glass lens



Item	Model	Diameter	Ship	Net
701328	400196-1	5-3/4"	1 lbs	\$36.00

**SEA-DOG LED DOME LIGHT • 18 WHITE LEDs**

- Solid teak base with a lacquer coated brass trim ring
- Very low current consumption at .068 amps at 12 Volt DC; extreme long life
- Gives off very low heat and is resistant to vibration
- Side-mounted On/Off toggle switch
- 18 White LEDs per light



Item	Model	Size	Ship	Net
701659	400209-1	6-1/8"L x 2-1/16"H	1 lbs	\$62.99

**SEA-DOG LED DAY/NIGHT DOME LIGHT**

- Lacquer-coated, polished brass body and trim ring
- Very low current consumption at .068 amps at 12 VDC; extreme long life
- Gives off very low heat and is resistant to vibration
- Side-mounted On/Off toggle switch
- 18 White LEDs per light and 12 Red LEDs

Item	Model	Size	Ship	Net
701660	400358-1	6-3/4"H x 2-1/8"H	1 lbs	\$67.99



**SEA-DOG DOME & DAY/NIGHT LIGHT**

- Power: 12 VDC (.068 Amps)
- Very low heat
- Resistant to vibration
- Fixture material: 304 Stamped Stainless Steel

Item	Model	Light	Size	Ship	Net
701264	400353-1	White (15), Red (5)	6-3/4"	2 lbs	\$54.99
701263	400193-1	White (18)	5-1/2"	1 lbs	\$39.99



**AQUA SIGNAL COLOMBO LED DOME LIGHT - WITHOUT SWITCH**

- Surface-mount with 3 screws (not included)
- Warm White LEDs for natural settings like living spaces
- Warm White light only - No switch
- Allows for one or more lights to be controlled by a main switch
- 12 VDC

Item	Model	Size dia.	Housing	Ship	Net
701573	16604-7	5-1/2"	White	1 lbs	\$35.99



**AQUA SIGNAL COLOMBO LED DOME LIGHTS**

- 12 VDC
- Surface-mount with 3 screws (not included)
- (21) Warm White and (9) Red LEDs
- Provides 195 lumens of light output
- Three-position switch (Warm White/Off/Red)
- 2 W White, 1 W Red
- Low power draw, @ 90% less than traditional incandescent fixtures

Item	Model	Size dia.	Housing	Ship	Net
701221	16601-7	5-1/2"	Stainless Steel	1 lbs	\$59.99
701222	16602-7	5-1/2"	White plastic	1 lbs	48.99



**AQUA SIGNAL SERIES 16 - BAMAKO LIGHT**

- Round LED headliner light • 0.07 A
- Surface mounted or recessed into headliner for flexibility
- Clear glass lens • 2-1/4" cutout
- Material:** Black ABS Plastic base **Mounting:** Surface or recess mount (3/4" depth) **Light Source:** 12 Warm White LEDs
- Voltage:** 12 VDC **Wattage:** 12 W **Dimensions:** 3-1/8" diameter, 3/4" depth

Item	Model	Housing/Light	Ship	Net
701076	16520-7	Chrome plastic finish/ Warm White	1 lbs	\$20.99



**LUMITEC TOUCH LED DOME LIGHT**

- Completely sealed • No o-rings, baffles or switches to wear out
- Bezel finish: Stainless steel • Power: 10-30 Volt DC
- Draw: 410 mA @ 12 Volt DC or 215 mA @ 24 Volt DC
- Proprietary Optical Field Sense technology provides touch control On/Off, color change and dimming
- Dims: 6.75" dia. x 1.13" Depth

Item	Model	Color	Ship	M.A.P.
701419	101097	White/Blue	1 lbs	\$119.00
	101098	White/Red	1 lbs	119.00



**SCANDVIK LED DOME LIGHT**

- Stainless steel dome with prismatic plastic lens
- 229 Lumens • Warm White (4000K)
- Surface mount • 12 Volt DC
- 20 Warm White LED bulbs • Includes side mounted On/Off switch

Item	Model	Size	Watts	Ship	Net
201177	41324	5-1/2"	1.7	1 lbs	\$28.99
201178	41325	6-5/8"	1.7	1 lbs	29.99



**SCANDVIK LED CEILING LIGHT - INTERIOR**

- Surface-mount ceiling light with switch
- Dimmable when connected to an external dimming module
- Warm White 2900-3200K 328 Lumens
- 12 Volt DC • Power consumption: 4 W

Item	Model	Size dia.	Housing	Ship	Net
701757	41340	5-1/2"	White	1 lbs	\$19.99



**SCANDVIK DUAL-COLOR LOW PROFILE LED DOME LIGHT**

- LED surface-mount dome light with bright, wide, even light
- 30 White LEDs/ 26 Color LEDs • White bezel
- Power: 12 / 24 Volt DC • Power Consumption: 6 Watts
- Switch toggles between White and Red or Blue
- Ingress Protection: IP 65

Item	Model	Size dia.	LED Color	Ship	Net
701779	41462	5"	Warm White / Red	1 lbs	\$27.99
	41461	5"	Warm White / Blue	1 lbs	27.99



**NEW!**

❖ For more detailed product specifications and our complete selection visit [www.defender.com](http://www.defender.com) or call 800-628-8225. ❖





A



B



C



D



D  
700SS



E

### A. WEEMS & PLATH DHR BERTH LAMP

• Solid brass, polished and lacquered • Gimballed for ease of use and placement  
 Item Model Description Ship Net  
 800120 8840/O 6.75" W x 11.25" H brass gimballed lamp 3 lbs \$173.99

### B. WEEMS & PLATH COMPANION LAMP

Crafted of solid cast brass, polished and lacquered. Hassle free, disposable fuel cell. Has a nonskid base with holes for permanent mounting. One disposable fuel cell with 17 hour burn time included with unit.

Item	Model	Description	Ship	M.A.P.
700822	818	3" D x 9" H companion lamp	2 lbs	\$64.99
700823	HD17-6	Replacement fuel cell (6 pack)	1 lbs	26.99

### C. WEEMS & PLATH ATLANTIC GIMBALLED OIL LAMP WITH SMOKE BELL

Constructed of solid brass. Comes complete with 4-way gimbal and smoke bell. Oil container capacity: 6 oz. Burn time: +/- 21 hours with clean burning lamp fuel.

Item	Model	Size	Ship	Net
700619	718	10" tall x 5" (with gimbal)	3 lbs	\$117.99

### WEEMS & PLATH LAMP FUEL AND REPLACEMENT WICKS

Clean, pure liquid paraffin lamp fuel. Highly refined to be smokeless and odorless.

Item	Model	Description	Ship	M.A.P.
800119	780	1 Quart lamp fuel	2 lbs	\$16.99
700818	00006W	Wick - 9" x 1.5"	1 lbs	Net 12.49
700820	770-3	Wicks - pack	1 lbs	8.99

### D. WEEMS & PLATH YACHT LAMPS

Made of solid brass. Lamps stand alone or can be mounted with either a brass wall hook or a brass gimbal. Gimbal and bracket sold separately. Each lamp measures 10" x 3-1/2" with a fuel capacity of 5 ounces and a burn time of +/-30 hours.

Item	Model	Description	Ship	M.A.P.
700332	700	Brass Yacht Lamp with brass bonnet	4 lbs	\$169.99
701782	700BK	Brass Yacht Lamp with Black bonnet	3 lbs	169.99
701781	700SS	Brass Yacht Lamp with stainless steel bonnet	3 lbs	169.99

### Brackets & Gimbals

700336	751	Brass wall bracket for Yacht Lamps	1 lbs	28.99
700337	951	Chrome wall bracket for Yacht Lamps	1 lbs	29.99
700335	705	Brass gimbal for Yacht Lamps	2 lbs	69.99

### E. WEEMS & PLATH DEN HAAN ANCHOR LAMPS

Solid brass; lacquered and polished. Two larger sizes are hoistable and provided with guide eyelets. 4.25 oz. oil capacity; burn time about 30 hrs. large/40 hrs. small.

Item	Model	Description	Ship	Net
700295	8611/O	4.375" Dia. x 9.5" H	4 lbs	\$234.99
700296	8604/O	5.50" Dia. x 12.4" H	6 lbs	254.99
700297	8603/O	6.69" Dia. x 14.17" H	8 lbs	296.99

❖ For more detailed product specifications and our complete selection visit [www.defender.com](http://www.defender.com) or call 800-628-8225. ❖

## LED Cabin Lights

### LUMITEC ILLUMINATION2 LED

Compact, attractive and fully positionable, the light shines a wide, even, neutral-warm, White beam, or choose a colored light to suit your mood.

• Power: 10-30 VDC, Draw: 580mA @ 12V and 320mA at 24V

Please specify: White LED with brushed aluminum housing  
 White LED with White aluminum housing  
 Red/Blue/White LED with brushed aluminum housing  
 Red/Blue/White LED with White aluminum housing

Item	Dimensions	Ship	M.A.P.
701421	2.52" L x 1.49" W	1 lbs	\$169.00

### SCANDVIK LED MICRO READING LIGHT

• Light color: Warm White • Rated for 50,000+ lifetime hours  
 • Current draw: 160 mA @ 12 VDC • Beam angle: 120°  
 • Integrated On/Off rocker switch • Chrome plated brass housing

Mount: Bulkhead Voltage: 10 - 30 Volt DC Power: 2 W

Output: 120 Lumens

Item	Model	Ship	Net
701617	41396	1 lbs	\$59.99

### SCANDVIK LED ALLURE READING LIGHT - INTERIOR

• Light Color: Warm White, Mount: Surface, Housing finish: SS  
 • Operating Voltage: 10-30 Volt DC, Power consumption: 3.1 Watts  
 • Swivels with adjustable angle, Integrated ON/OFF switch

Item	Model	Ship	Net
701755	41397	1 lbs	\$74.99

### SCANDVIK LED READING LIGHT - INTERIOR

• Light Color: Warm White, Mount: Surface, Housing finish: SS  
 • Operating Voltage: 8-30 Volt DC, Power consumption: 3.1 Watts  
 • Swivels and turns in any direction, Integrated ON/OFF switch

Item	Model	Ship	Net
701756	19053	1 lbs	\$61.99

### SCANDVIK LED READING LIGHT

High output, economical LED, swivels in any direction.

• Polished brass with (16) LED bulbs • Power: 8-30 Volt DC  
 • ON/OFF switch located on base  
 • Draw: 0.258 Amp @ 12 Volt DC or 0.129 Amps @ 24 Volt DC

Item	Model	Ship	Net
701702	19052	1 lbs	\$54.99

### I2SYSTEMS LED READING LIGHT - INTERIOR

• LED Color: Warm White, Mount: Surface • Anodized Aluminum finish  
 • Operating Voltage: 9 - 30 Volt DC, Current Draw: 160 mA @ 12 Volt DC  
 • Fully Adjustable Ball Joint Swivel Design, Integrated On / Off Switch

Item 701322	Model T3311Z-11MCAB	Ship 1 lbs	M.A.P. \$130.00
-------------	---------------------	------------	-----------------

### IMTRA LED LIGHTS

High flux "Warm White" LEDs with voltage/current-regulated internal driver, protected with built-in heat sink.

• Universal input voltage for 12 or 24 Volt DC systems • Vibration/shock proof  
 • Low maintenance: 50,000 hours of life

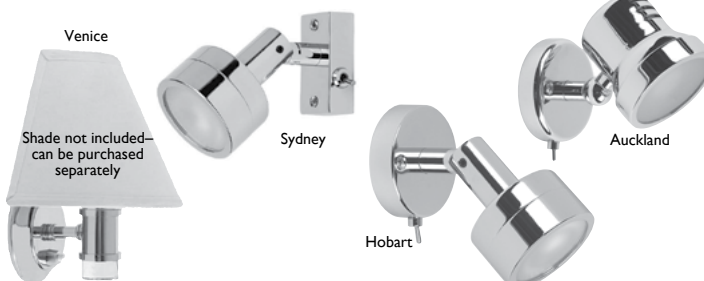

### Venice LED Wall Light

Dimensions: 8.19" x 7.68" x 5.75", 10-30 Volt DC, built in ON/OFF

Item	Model	Housing/Bulb	Ship	Net
701207	ILSH60150	Stainless steel/Warm White LED	1 lbs	\$124.99
701208	ILSH60190	Shade (half-shade)	1 lbs	17.99

### Sydney LED Reading Light

Base: 2.26" x .98" / Lamp Dia.: 2.16" / Length: 4.30"

Item	Model	Trim Ring/Bulb	Ship	Net
990022	ILIM40501	Chrome/Warm White LED	1 lbs	\$143.99

### Hobart LED Reading Light

Base Dia.: 2.30" / Lamp Dia.: 2.16" / Length: 4.214"

Item	Model	Trim Ring/Bulb	Ship	Net
701096	ILIM40401	Chrome/Warm White LED	1 lbs	\$149.99

### Auckland Reading Light

Base Dia: 2.54" / Lamp Dia: 2.62" / Length: 4.37"; screw mount

Item	Model	Finish/Bulb	Ship	Net
701155	ILIM40601	Chrome with Warm White	1 lbs	\$149.99

### SEADOG DELUXE HIGH POWER LED READING LIGHT WITH SWITCH

The deluxe high-power LED reading light is constructed of cast 316 stainless steel and chromed aluminum. It features firm swivel adjustment and a soft push button switch. Bright LED produces 470 LUX light output. 12-28 Volt DC.

Item	Model	Base/ Housing Material	Ship	Net
701722	404531-1	Cast 316 stainless steel/ chromed aluminum	1 lbs	\$72.99



## Reading Lights / Chart Lights



### A. SEA-DOG BERTH LIGHT

- Machined and stamped polished lacquer coated brass
- Interior surface of lamp shade is White enamel
- Bulb: 15 W double contact bayonet (included)
- Easily converted to LED with bayonet bulb socket adapter and G4 bulb
- 4-3/8" Deep x 3-3/4" Tall

Item	Model	Description	VDC	Amps	Watts	Ship	Net
701324	400400-1	Brass	12	1.25	18.4	1 lbs	\$48.99

### B. SEA-DOG CABIN LIGHT

- Machined and stamped polished brass body; lacquer coated
- Traditional styling
- Bulb: 10 W single contact bayonet bulb (included)
- Easily converted to LED with bayonet bulb socket adapter and G4 bulb (sold separately)

Item	Model	Description	VDC	Amps	Watts	Ship	Net
701325	400430-1	Brass	12	.83	10	1 lbs	\$39.99

### C. IMTRA ST. MAARTEN GLASS READING LIGHT

- Excellent for accenting a painting, illuminating small spaces or swivelling to desired location.
- G4 Halogen or G4 LED bulb sold separately
  - Operating voltage: 10-30 Volt DC

Item	Model	Description	Ship	Net
701699	ILSH41081	Stainless steel housing; Blue-green swirl globe	1 lbs	\$179.99

### D. AQUA SIGNAL LED READING / CHART LIGHT

- Stainless steel housing
- Operating voltage: 12 Volt DC, Current draw: 25 mA (White)
- Wall or table mounted

Item	Model	Description	Ship	Net
701711	16501-7	LED Reading / Chart Light with 14" swivel arm, integrated 3-way switch	1 lbs	\$84.99

### E. DR. LED BLACK COBRA LED CHART/READING LIGHT

- On / Off / On push-button switch located at the base
- Select either warm White or Red light output
- Incredibly low power draw (0.2A @ 12 Volt DC)

Item	Model	Description	Ship	M.A.P.
701284	9000029	Plated zinc alloy head/base; coated metal gooseneck	1 lbs	\$89.99

### F. SEA-DOG CHART LIGHT

- Cast brass halogen chart light
- Bulb: 10 Watt MR-16 Halogen
- Prewired with On / Off Switch
- 9-3/4" Flexible neck
- Includes a 2" reflector and clear glass lens
- Fasteners: #6 RH (sold separately)

Item	Model	Description	VDC	Amps	Watts	Ship	Net
701326	400540-1	Brass	12	.83	10	1 lbs	\$30.00

### G. AQUA SIGNAL LED FLEXIBLE NECK LIGHT

- Red / White LED light option
- Wall or table mount (3 screws included)

Item	Model	Neck Length	Watt	VDC	Ship	Net
701046	16500-7	11"	9 W (White), 4 W (Red)	12	1 lbs	\$44.99

### H. HELLA FLEXIBLE LED CHART TABLE LAMP

- Current draw less than 2 W (less than 0.16A @ 12 Volt DC)
- On/Off switch is built into the head for easy operation
- Multivolt™ electronics provide consistent illumination and circuit protection across a range of inputs from 9-31 Volt DC

Item	Neck Length	Bezel	LED	Ship	Net
700449	16"	Black	Specify Red or White	1 lbs	\$119.99

### I. HELLA HALOGEN MAP LIGHT

- Compact lamp head with switch
- Includes a bracket and spare Red lens
- Large rectangular lens
- Bulb included

Item	Model	Description	VDC	Watts	Ship	Net
700414	004532161	19" Flexible metal arm	12	6	1 lbs	\$51.99

### J. SEA-DOG CHART LIGHT/CIGARETTE LIGHTER COMBO

- Dual function with the flick of a switch
- Chrome steel sockets should only be used on fresh water boats
- Includes stainless steel 304 mounting plate

Item	Model	Description	VDC	Watts	Ship	Net
700045	426312-1	Chart light/cigarette lighter	12	5	1 lbs	\$14.99

## Deck / Dock Lights

### TAYLORBRITE SOLAR POWERED LED DOCK LIGHT

- Can be easily attached to any flat surface with two 1/4" screws
- Charges during the daytime and automatically turns on at dusk
- (4) Super bright white LEDs
- A clear plastic weather resistant housing offers 360° illumination

Item	Model	Ship	Net
701026	46109	1 lbs	\$37.99

### TAYLOR SOLAR LED DOCK & DECK LIGHT

- (3) colors built in with a push of a button (Bright White, Candlelight, Blue)
- (3) LEDs illuminate simultaneously
- Replaceable AAA NiMH rechargeable battery
- Auto ON/Off at dusk and dawn
- Waterproof for heavy rain, wind and snow
- No wiring needed
- Duration of light output varies directly with the amount of sunlight exposure

Item	Model	Ship	Net
012332	46206	1 lbs	\$21.99

### TAYLOR SOLAR LED ALUMINUM DOCK LIGHT

- Marine grade solar deck light designed for superior weather resistance in marine environments.
- IP68 waterproof design
- Powerful solar panel
- Low profile design
- 4.125" W x 4.125" L x 0.875" H
- Built-in reflector for extra safety
- Hassle-free mounting: no wires, no electrical cost

Item	Model	Ship	Net
012415	46310	2 lbs	\$29.99



### SCANDVIK LED SOLAR POWERED DOCK LIGHTS

- Uses solar power to charge the battery during the daytime and turns on automatically at night
- Stainless steel wood screws included
- Material: Polycarbonate housing
- LED Color: Cool White
- LED Beam Angle: 30°
- Solar Battery: 2 Volt DC / 0.4 W
- Charge Battery: NI-MH AAA 650 mAh 1.2 Volt DC
- Operating Temperature: -4°F - 122°F
- Waterproof Protection: IP67

Item 701794 Model 41750 Ship 1 lbs Net \$29.99/Pair



### TAYLOR RECESSED WIRED LIGHT SET

- Recessed lights drop into a 1" diameter drilled hole for a clean flush look. Solar panel can be positioned remotely.
- (3) AA NiMH user replaceable batteries
- Lights measure approximately 1-5/8" in diameter
- Quick disconnects between each light

Item	Model	Description	Ship	Net
012410	46306	Light set with solar panel	2 lbs	\$44.99
012411	46307	(3) lights expansion pack	2 lbs	17.99



### TAYLOR SURFACE MOUNTED LIGHT SET

- Same function as Taylor recessed wired light set but with no holes to drill. Solar panel can be positioned remotely.
- (3) AA NiMH user replaceable batteries
- Lights approximately 1/2" tall with side mounted wires
- Quick disconnects between each light

Item	Model	Description	Ship	Net
012412	46308	Light set with solar panel	2 lbs	\$42.99
012413	46309	(3) lights expansion pack	1 lbs	18.99





# Replacement Bulbs

All bulbs on this page ship 1 lbs.

## NAVIGATION

### DR. LED 28-31MM FESTOON STAR™ BULB

- High-power LED; Visibility: 2 NM
- 12 Volt DC; Draw: 0.1 A
- For most combination masthead and anchor lights

Item	Model	Color	M.A.P.
701223	9000173	White	\$26.09



### DR. LED HEX GE90 STAR NAVIGATION LED

- Base: double-contact bayonet BA15D, non-indexed
- Input voltage: 12 Volt DC
- Current draw: 0.12 Amp
- Output: 90 lumens; Visibility: 2 NM

Item	Model	Color	M.A.P.
701478	9000425	Warm White	\$26.09



### DR. LED POLAR STAR™ 40 SERIES BULBS

- Base: double-contact bayonet BAY15D, Indexed
- Input voltage: 12/24 Volt DC
- Very low power consumption (approximately 1-2W)
- Visibility: 2 NM

Item	Model	Color	M.A.P.
700541	8001771	Green	\$44.99
700442	8001757	White	44.99
700540	8001764	Red	44.99



### DR. LED POLAR STAR 20 LED NAVIGATION LIGHT REPLACEMENT BULB

- Base: 9 mm single-contact bayonet BA9S, non-indexed
- Input voltage: 12 Volt DC, Draw: 0.1 amp
- For navigation lights
- Visibility: 2 NM

Item	Model	Color	Lumens	M.A.P.
701477	8001849	Warm White	60	\$22.49



## INTERIOR

### SCANDVIK MINI TOWER LED REPLACEMENT BULB

- Input voltage: 12 / 24 Volt DC
- Current draw: 0.16 A
- Replaces BA15S bulbs

Item	Model	Color	Lumens	LEDs	Net
701695	41034	Warm White	175	8	\$11.99



### SCANDVIK G4 LED

- Input voltage: 12-24 Volt DC • 1.5 watts
- Replaces G4 Bi-Pin Bulb

Item	Model	Color	Lumens	Net
701694	41072	Warm White	180	\$15.99



### DR. LED STAR 36-44 MM FESTOON STAR LED REPLACEMENT BULB

- Input voltage: 12 Volt DC
- Current draw: 0.14 A
- Visibility: 2 NM, replaces most 39 - 44 mm festoon bulbs

Item	Model	Light Color	Lumens	M.A.P.
701767	9000241	Warm White	90	\$35.99



### DR. LED SINGLE SIDED WEDGE BASE SMD LED REPLACEMENT BULB

- Input power: 12 Volt DC, Draw: 0.045A, Equal to 5 watt incandescent
- Ideal for cockpit lights, map / reading lights, emergency lights, etc.

Item	Model	Light Color	M.A.P.
701370	8001559	White	\$4.50



### DR. LED EDISON SIDEKICK 3X LED WITH HOUSEHOLD STYLE BASE

- Base: Medium Edison screw base E26 / E27
- Power: 12 Volt AC/DC or 24 Volt DC
- Draw: 6 watts
- Includes (3) US made high-power LEDs
- Replaces 60 watt incandescent bulbs

Item	Model	Light Color	M.A.P.
701454	8001818	Warm White	\$29.69



### DR. LED MAGNUM RING MKII LED REPLACEMENT BULB

- Base: single-contact bayonet BA15S non-indexed
- Input voltage: 12 Volt DC
- Power consumption: 1 watt

Item	Model	Light Color	Lumens	M.A.P.
701366	8001245	Warm White	150	\$19.57



### DR. LED DOME LIGHT SMD LED BULB CONVERSION KIT

- Replaces bi-pin or 15mm bayonet (BA15D)
- Input power: 12 Volt DC, Draw: 0.18 A
- Ideal for cockpit lights, map / reading lights, emergency lights, etc.
- For dome lights with two bulbs, one red & one white.

Item	Model	Light Color	Lumens	M.A.P.
701372	9000333	Red / White	135	\$23.39



### DR. LED MINI G4 STAR

- For reading lights, recessed lights, nav lights, etc.
- General one-to-one G4 bulb LED
- 12 Volt DC only; 0.1 A • 60 lumens

Item	Model	Color	M.A.P.
701479	9000432	White	\$16.87



### DR. LED SMD BAYONET 15 TOWER

- 12 Volt DC; Draw: 0.2 A • For reading lights

#### Single contact non-indexed

Item	Model	Color	M.A.P.
701227	9000111	Warm White	\$13.05

#### Double contact non-indexed

701228	9000128	Warm White	13.05
701229	9000135	Red	13.05

#### Double contact, indexed

701230	9000142	Warm White	13.05
--------	---------	------------	-------



### DR. LED SMD G4/MR11 BULB

- Bi-pin base • 30 mm (1.2") diameter
- For reading, recessed and dome lights
- Both side and back pins provided.
- 12 Volt DC, Draw: 0.13 A
- Zero RF Emission.

Item	Model	Color	M.A.P.
701224	9000081	Warm White	\$13.49
701225	9000098	Red	10.79



### DR. LED SMD DOME CONVERSION KIT

- Double contact; non-indexed
- 12 Volt DC; Draw: 0.18 A
- For dome lights
- 50 mm (2") diameter
- Bi-pin and bayonet connectors provided
- Zero RF Emission.

Item	Model	Color	M.A.P.
701231	9000159	Warm White	\$21.59



## Dr. LED Replacement Bulbs

### REPLACEMENT LED SEALED BEAM

- Voltage: 12/24 Volt DC
- Draw: 0.8 A @ 12 Volt DC
- Waterproof: IP67
- Non-polarized connection
- Applications: Spreader and foredeck lights
- Replaces 50 Watt halogen beam
- ETL US certification



Item	Light Color	Lumens	M.A.P.
701801	Cool White	700+	\$71.99

### SINGLE-SIDED FESTOON BULBS

- Voltage: 12/24 Volt DC
- Current Draw: 0.12 A @ 12 Volt DC
- Replaces pointed festoon bulbs
- Built-in regulated power supply
- Long service life, shockproof, ultra-rugged with no filament to burn out or break
- Sold in pairs



Specify Base: S8.5 Festoon 31 / 36 / 41 mm

Item	Light Color	Lumens	M.A.P.
701802	Cool White	150	\$22.49

## Imtra LED Replacement Bulbs

### IMTRA MINI G4 LED REPLACEMENT BULB

- 10-30 Volt DC (1.5 W)
- For small down lights and spots
- Current draw: 120 mA @ 12 Volt DC

Item	Color	LEDs	Net
701683	Blue	9	\$11.99



### MINI - LED G4, Socket, back pin

- 10-30 Volt DC (1.5 W)
- For small down lights and spots

Item	Color	Lumens	LEDs	Net
701534	Warm	120	9	\$16.99



### X-BEAM LED - G4 Socket, side pin

- 10-30 Volt DC (2.2 W); directional
- For down lights and shallow spots

Item	Color	Lumens	LEDs	Net
701130	Warm	120	10	\$16.99
	Cool	150	10	16.99



### MINI - G4 LED Socket, back pin

- 10-30 Volt DC (1.5 W); directional
- For small down lights and spots

Item	Color	LEDs	Net
701611	Cool	9	\$13.99



### X-BEAM LED - G4 Socket, back pin

- 10-30 Volt DC (2.2 W); directional
- For downlights, spots and reading lights

Item	Color	Lumens	LEDs	Net
701143	Warm	170	10	\$16.99
	Cool	150	10	16.99



### MINI TOWER - GU4 Socket, back pin

- 10-30 Volt DC (1.3 W); omnidirectional
- For tube, sconces and small reading lights

Item	Color	Lumens	LEDs	Net
701125	Warm	85	15	\$13.99



### MINI - BA15S Socket, single contact bayonet

- 10-30 Volt DC (1.5 W); directional
- For bell-shaped reading and chart lights

Item	Colors	Lumens	LEDs	Net
701321	Warm	70	6	\$16.99



### X-BEAM LED - G4 Socket, side pin

- 10-30 Volt DC (1.6 W); directional
- For small down lights and shallow spots

Item	Color	Lumens	LEDs	Net
701553	Blue/Cool	110	9	\$19.99
	Red/Warm	110	9	19.99



### TOWER LED NAVIGATION BAYONET BAY15d Double contact

- 10-30 Volt DC (3.0 W); omnidirectional
- For Red, Green or Tri-color running lights (warm) or masthead, sternlight (cool)

Item	Color	Lumens	LEDs	Net
701282	Warm	260	18	\$24.99
	Cool	275	18	24.99



### MINI-BA15D Socket, bayonet double contact

- 10-30 Volt DC (1.0 W); directional
- For bell-shaped reading and chart lights

Item	Color	Lumens	LEDs	Net
701320	Warm	70	6	\$16.99



### TOWER - B15D Socket, double contact

- 10-30 Volt DC (2.50 W), omnidirectional
- For appliques and table lamps

Item	Color	Lumens	LEDs	Net
701150	Warm	230	18	\$24.99



### LED 42MM FESTOON - SV8.5 - CONE END

- 8-30 Volt DC (1.5 W); directional
- For dome lights and courtesy lights

Item	Color	Lumens	LEDs	Net
701151	Warm	72	6	\$16.99
	Red	25	6	16.99



## Sensibulb Replacement Bulbs

### SENSIBULB LED LIGHT BULB REPLACEMENT

- 10-32 Volt DC, 0.16 A, Size: 1.00" x 1.00" x 5/8"

Item	Model	Bulb Color	Net
700433	10010	White	\$41.99

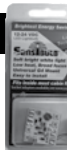

### Bulb Adaptor

700435	10014	G4 to double bayonet	3.99
700436	10015	G4 to single contact bayonet	3.99

### Bayonet Bulb Socket Adaptor

701523	10016	Converts Edison type socket (medium screw) to G4 socket	3.99
--------	-------	---------------------------------------------------------	------

**UPS GROUND BUSINESS DAYS IN TRANSIT**

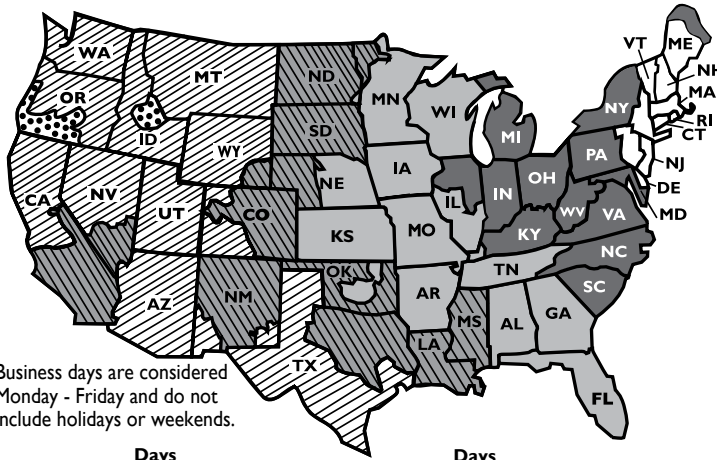

Business days are considered Monday - Friday and do not include holidays or weekends.



**SHIPPING INFORMATION**

**MOST PACKAGES SHIP SAME DAY**

Most orders placed before 4:30pm Eastern Time Monday – Friday will be processed the same business day. Custom orders and US Postal Service orders must be placed by 2:30 pm Eastern Time to be processed the same business day. Same day processing excludes custom ordered items, international, truck freight, boats and motors and drop shipments.

**UP FRONT SHIPPING**

With few exceptions, we charge all shipping up front, so you don't pay extra for any separate shipments due to back orders or drop shipped items.

We ship UPS, UPS SurePost, FedEx, US Postal Service and Truck. APO, FPO, or PO Box addresses must go US Postal Service or SurePost. Call for international pricing or visit [www.defender.com/IntShipCalc.html](http://www.defender.com/IntShipCalc.html).

**SAVE ON SHIPPING!**

You can save on shipping by having your order shipped to a commercial address. For example, you can ship to your place of business, a marina, local store, or most commercial establishments. By sending your package to a commercial address, your delivery is more secure as it is signed for and not exposed to weather conditions. Whether you chose standard service or expedited delivery to a commercial address, you will save the residential fee of \$2.95, even more on expedited and truck shipments.

**SHIPPING POLICIES**

**DETERMINING SHIPPING WEIGHT:**

Actual, dimensional, or minimum package weights may be used to determine the charge for a shipment.

**BILLABLE WEIGHT**

The billable weight will be the greater of the dimensional weight as compared to the actual weight.

**GROUND DIMENSIONAL WEIGHT**

is calculated as  $(L \times W \times H > 5184) / 194$

**DOMESTIC AIR DIMENSIONAL WEIGHT**

is calculated as  $(L \times W \times H) / 139$ .

**International Dimensional Weight**

is calculated as  $(L \times W \times H) / 139$

**LARGE PACKAGE SURCHARGE**

A package is considered a large package if its combined length and girth exceeds 130" but weighs less than 90 lbs. The large package surcharge is \$90.00 and a minimum billable weight of 90 lbs.

**ADDITIONAL HANDLING FEES CHARGED BY PARCEL CARRIERS** Items with irregular packaging, where the outside container is wood or metal, or any article not encased in a corrugated container, or any package exceeding 48" in length incur a \$14.25 charge. Items whose length exceeds 96" or girth exceeds 130" will incur a \$60.00 large package handling fee.

Insurance is required for the total value of each shipment. Add 90¢ for each \$100 value or part thereof above the first \$100.

Parcel carriers impose a fee for delivery to rural addresses. \$3.85 for residential, \$2.80 for commercial. Extended rural addresses incur \$4.70 for residential, \$2.95 for commercial.

Orders over \$2500 require a signature for delivery.

Hazardous items (A) incur a \$35.00 fee per box and ship via ground (G) only.

**REFUSED OR RE-ROUTED PACKAGES** Any refused packages or packages needing an address correction will be charged for shipping costs and all fees associated with the shipment.

**SHIPPING RATE ZONES**

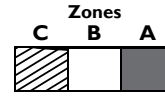
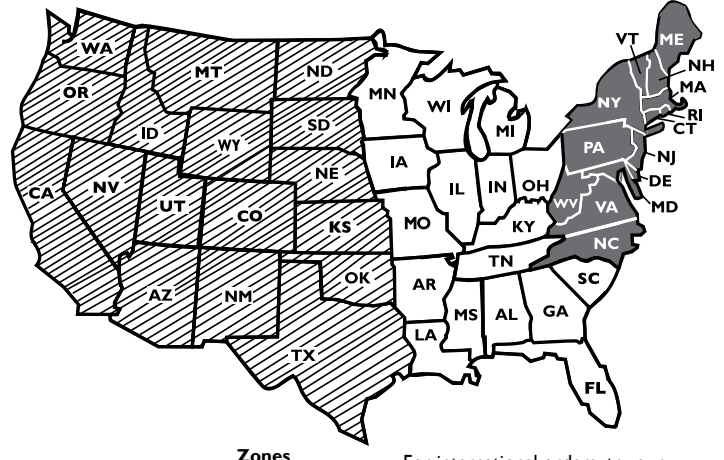

For international orders, try our international shipping calculator at [www.defender.com/intshipcalc.html](http://www.defender.com/intshipcalc.html)

**SHIPPING RATES**

SUREPOST			
Weight	A	B	C
1	6.90	7.45	7.75
2	7.25	8.30	8.85
3	7.50	8.90	9.65
4	7.75	9.35	10.40
5	7.90	9.70	10.90
6	8.10	9.90	11.05
7	8.40	10.20	11.55
8	8.60	10.40	11.95
9	8.75	10.60	12.25

US POSTAL SERVICE PRIORITY MAIL			
Weight	A	B	C
1	7.15	7.80	8.70
2	7.50	10.75	12.90

UPS GROUND RESIDENTIAL (subtract \$2.95 for commercial addresses)			
Weight	A	B	C
1	9.40	9.55	9.90
2	9.65	10.10	10.50
3	9.70	10.60	11.20
4	9.80	11.05	11.90
5	9.90	11.35	12.30
6	10.40	11.70	12.55
7	10.45	11.85	12.60
8	10.50	12.10	13.25
9	10.65	12.20	13.55
10	10.75	12.50	14.60
11	10.90	12.45	15.05
12	10.95	12.65	15.70
13	11.15	12.90	16.55
14	11.30	13.30	17.35
15	11.40	13.80	18.05
16	12.00	14.55	19.35
17	12.25	15.05	20.15
18	12.35	15.60	20.90
19	12.40	15.80	21.50
20	12.60	16.40	22.35

**SurePost**

**SAVE on shipping** with this hybrid service for smaller size items & orders less than 9 pounds total shipping weight that are shipping to a residential address. Orders ship UPS ground to your local post office who then delivers it directly to you – all easily tracked online. Customers in rural areas incur only a \$1.85 rural delivery fee or a \$2.35 extended rural delivery fee compared to \$2.80-4.70 with other carrier services. Delivery typically takes just a day longer than UPS ground, but is not guaranteed.

EXPEDITED SHIPPING 48 CONTINENTAL STATES			
	1 Day	2 Day	3 Day
1	27.25	16.90	14.60
2	30.80	18.10	16.20
3	33.85	20.45	17.65
4	36.65	22.15	19.05
5	38.55	24.00	20.70
6	41.15	25.60	22.10
7	43.70	27.50	23.75
8	46.30	29.60	24.70
9	48.65	31.50	26.80
10	50.55	33.60	28.20
11	54.05	35.70	29.60
12	56.65	37.85	31.15
13	58.75	39.75	32.70
14	61.35	41.60	34.10
15	63.45	43.25	35.50
16	65.35	44.85	36.90
17	66.70	46.70	38.10
18	68.40	48.60	39.45
19	69.80	50.30	40.65
20	73.10	51.95	42.10

21-69 LBS ADD THE FOLLOWING PER LB TO THE 20 LB RATE						
Add	0.40	0.55	0.60	2.50	2.10	1.75

ABOVE 70 LBS ADD THE FOLLOWING PER LB TO THE 70 LB RATE						
70#	34.50	47.25	60.75	212.50	162.75	143.50
Add	0.60	0.55	0.55	2.50	2.00	1.75

\*Pricing for packages over 70 pounds includes \$16.00 carrier imposed additional handling fee.

**TRACK YOUR SHIPMENT ON OUR WEBSITE!**

If you want to track your shipment, visit our home page [www.defender.com](http://www.defender.com), click on "Track My Package(s)" & enter your order number.



## SPECIAL ORDERS ARE OUR SPECIALTY

**TO PLACE A SPECIAL ORDER:** Our representatives will be happy to assist you with all of your special orders. Please supply us with all manufacturer information pertaining to the product you wish to order (i.e., model number, name and color). Defender is not responsible for incorrect manufacturer information.

**With few exceptions, Special Orders may not be cancelled or returned.**

## PLACING ORDERS

**TO PLACE AN ORDER:** Please have ready the item number, model number, size, style, color, credit card information, name and address where the credit card is billed, separate shipping address (if applicable), daytime phone number, email address for electronic confirmation and all other shipping information. \$25 minimum order required.

**BACKORDERS:** If an item is subject to a manufacturer's delay, we will not charge you for the item(s) until shipped, with the exception of Special Orders and items shipped directly from the manufacturer (see below).

**DIRECT FACTORY SHIPMENTS (Drop Ship):** Items shipped directly from the supplier/manufacturer are billed at the time of order and sometimes incur an additional service fee imposed by the supplier. Shipping charges from the supplier's location may apply for these drop-shipped items, including those shipped directly to Defender's Outlet Store for customer pick-up.

**PRICING AND AVAILABILITY:** Please note that prices are subject to market conditions and therefore may change without notice. Some manufacturers' pricing is uncertain at time of publication. Certain products may be withdrawn from sale at any time or may not be continuously in inventory. Check online at [www.defender.com](http://www.defender.com) for the most current pricing and availability.

## METHODS OF PAYMENT

**METHODS OF PAYMENT:** We accept Visa, MasterCard, American Express, money orders, wire transfers, and personal checks in U.S. Funds only. There is a \$25 fee for domestic wire transfers and \$45 for international wire transfers. To avoid verification and approval delays on credit card orders, be sure to provide the exact address to which your card is billed.

Credit card authorization for international orders can cause a delay. International orders paid by wire transfer will not experience a delay.

**SALES TAX:** Defender only collects and remits sales / use tax for the states whose laws require us to do so (based on the state the order is shipped to).



## INTERNATIONAL AND FREIGHT FORWARDER SHIPMENTS

**ORDERS SHIPPING TO A FREIGHT FORWARDER:** All orders shipped to a freight forwarder will be assessed an administrative fee up to \$20.00. Please designate a freight forwarder and provide us with the following information – freight forwarder's full name, contact person, address, phone number and email along with the final destination name, address, phone number or email address. Shipments by Defender are insured to the freight forwarder's location only. If you require insurance to the final destination, you must request the freight forwarder to insure your merchandise in full to the final destination to replace as new if necessary.

**SHIPPING REGULATED/HAZMAT ITEMS TO YOUR FORWARDER:** When making arrangements with your forwarder you must advise them, prior to booking, if you will be transporting any Hazmat or regulated items. These items typically include liquids, gases, powders or batteries and are designated by a ☉ or ☠ symbol. You must advise the forwarder that Defender packages and labels for US DOT ground transport only. It is your responsibility to ensure your forwarder is able to repackage and relabel for Ocean or Air Shipments. We will assist you and the forwarder when possible with documentation.

**CUSTOMS, DUTIES, AND IMPORT FEES:** Defender will assist you, however, customs procedures vary from country to country and agent to agent. Please check with local officials regarding cost and proper procedures for labeling. Sometimes labeling your order as "Yacht in Transit" or applying for a Cruising Permit may reduce or help to avoid customs charges and/or duties. Defender can provide a pro forma invoice if needed. Defender is not responsible for customs charges and duties or delays by custom officers, shipping agents or flight delays once the shipment leaves our warehouse. Defender will bill for any duties and taxes that are charged back to us after the initial shipment.

WANT AN EXTRA CATALOG FOR YOUR BOAT?  
IS YOUR MARINA NEIGHBOR ALWAYS BORROWING YOUR CATALOG?

**GET A FREE CATALOG!!**

Go to [WWW.DEFENDER.COM/CATALOG](http://WWW.DEFENDER.COM/CATALOG)  
or email [customerservice@defender.com](mailto:customerservice@defender.com) or telephone 800-628-8225.  
Please allow 5-10 days for delivery. If you need your catalog faster, call us.

## SECURITY AND PRIVACY STATEMENTS

**Security:** Your personal information is protected, and your credit card information is encrypted. When you shop on-line with Defender.com, your transactions are encoded using AES 128-bit encrypted SSL technology.

**Privacy:** We respect your privacy. All personal information you provide us is kept confidential. We do not rent, trade, sell or share your personal information. Ever. Period.

## RETURN POLICY

**RETURN POLICY:** We want you to be a satisfied customer, and we need your help to maintain our wide selection, name brands, low prices and large on-hand inventory. We reserve the right to refuse returns or assess additional fees at our discretion if the merchandise is not in the original packaging and ready-to-be-sold condition.

### How to Return an Item:

1. Request a Return Merchandise Authorization (RMA) Number by contacting Customer Service: [customerservice@defender.com](mailto:customerservice@defender.com), 800-435-7180 or 860-701-3400, or go to [www.defender.com/rma\\_form.jsp](http://www.defender.com/rma_form.jsp). The returned product must be postmarked within 15 days of RMA number issuance or the RMA number will expire.
2. Repack the product in the original packaging and place inside a box suitable for shipping with all the original enclosures, parts and accessories.
3. Return it to us postage pre-paid (we do not accept C.O.D.), with the appropriate insurance. Please note: Shipping costs are non-refundable.

### Non-Returnable:

Inflatable boats, outboard motors, liferafts, trailers, opened software, programmed transponders, items with expiration dates, cut goods, products with a broken seal, unlock codes for software or other customer specific products, clearance items, close-outs, discontinued, specially ordered items and gift certificates are not returnable. If these items are found to be damaged or defective, you must notify us within 10 days for resolution. Unfortunately, we cannot accept returns older than 30 days.

### 30-Day Returns:

Except as noted above, products in the original packaging and ready-to-be-sold condition may be returned within 30 days for a full exchange or refund of merchandise price. Unused items not returned in their original condition within the 30 days, if accepted, will be subject to a handling fee for inspection, repackaging and restocking. We reserve the right to refuse returns or assess additional fees at our discretion if the merchandise is missing parts or is not in new condition.

### Defective Products / Warranty Information:

Most items we sell are covered by manufacturers' warranties. If you experience difficulty with a product, please contact the appropriate manufacturer for assistance and troubleshooting help, or email [CustomerService@defender.com](mailto:CustomerService@defender.com) or call 800-435-7180. We will work with you and the manufacturer to resolve any issues.

## DAMAGED GOODS

### DAMAGED OR MISSING GOODS SHIPPED BY PARCEL CARRIER:

We thoroughly inspect all items prior to shipment. We suggest that you also thoroughly inspect the items before accepting delivery. If damage is apparent, refuse delivery, or, if your parcel is left without a signature and damage is found, please contact Defender Customer Service immediately at 800-435-7180. Do not discard the box or any packaging materials.

**DAMAGED GOODS SHIPPED BY TRUCK:** All truck shipments must be inspected with the driver present. If damage is apparent, refuse delivery. If accepting delivery make a note of any damage or shortages when signing the bill of lading and contact Defender Customer Service immediately at 800-435-7180. Do not discard the box or any packaging materials. Most claims must be filed with the carrier within 5 days of receipt of delivery.

## SHIPPING SYMBOLS USED IN OUR CATALOG

These categories are based on the policies set by the carriers.

**D** = Product ships at dimensional weight, which is explained in detail on p.310.

**T** = Ships via truck.

**☉** = Must ship by ground only.

**☠** = Hazardous Material (HazMat). \$35.00 shipping fee imposed by carrier. Must ship by ground only.

**MISTAKES DO HAPPEN:** Typographical, photographic, pricing and editing errors in our catalog, flyers, advertising and website are unintentional and we reserve the right to correct them.





Phone/TV Cordsets .....281, 283  
Shore Power.....281-283  
Steering.....40

**Cable Clamps**.....295  
**Cable Clams**.....295  
**Cafra Fans**.....149  
**Cam Cleats**.....74, 78  
**Camco Winterizing Tools**.....220  
**Cameras**  
Thermal/Night Vision.....261

**Canvas**  
Adhesives.....176  
Boat Covers.....219  
Boat Shades.....180  
Buckets.....206  
Cleaners.....205  
Clear Vinyl.....180  
Covers.....180  
Drapery Systems.....176  
Fabric.....176  
Fabric Fasteners & Kits.....178  
Grommets.....178  
Headliner.....180  
Hook & Loop.....177  
Naugahyde/Seaquest.....176  
Protectants.....205  
Repair Kits.....178  
Sail Repair.....177  
Sail Ties.....91, 179  
Sail Twine.....177  
Sewing Kits.....177  
Sewing Machines.....177  
Snaps.....178  
Sunbrella.....176  
Tape, Seaming.....176  
Tarps.....219  
Thread.....177  
Tools.....178  
Zippers.....177

**Cape Hatteras**  
Boarding Mats.....60  
Fender Covers.....60

**Carabiners**.....190  
**Carpeting**.....175  
**Caulks**.....191  
**CD Players**.....232-234  
**Centek Mufflers & Exhaust Fittings**.....33  
**Chafe Guards & Kits**.....51  
**Chain**  
Accessories.....45-46  
Connectors.....45  
Counter.....53, 55  
Drums, Half & Full.....45  
Grab Hooks.....45  
Links.....45  
Markers.....45  
Mooring.....45  
Selection Guide.....45  
Snubbers.....51  
Stainless Steel.....45  
Stoppers.....50, 53

**Chairs**  
Bosun's.....94  
Deck.....183-184  
Director.....183  
Fixed Mount.....184-185  
Folding.....183  
Helm.....184-185  
Lounge.....185  
Pedestals.....184  
Portable.....183  
Tips, Non-Marking.....183

**Chapman Piloting Book**.....228  
**Charge Control Devices**.....277  
**Chargers, Battery**.....277, 280, 284-286, 288-289  
**Charging Port**.....256  
**Charles Marine Iso Transformers**.....284  
**Chartbooks**.....222  
**Chartlights**.....308  
**Chartplotters/Sounders**  
B&G.....262  
Furuno.....270-271  
Lowrance.....263-264

Raymarine.....261  
Simrad.....263  
Si-Tex.....267

**Charts**  
Charting Guides.....222  
Digital.....230, 257, 260  
Electronic.....222, 230, 257, 260  
PC.....230, 260  
Waterproof.....222

**Check Valves**.....102  
**CHIRP Sonar**.....258-61, 263-265

**Chocks**  
Anchor.....51  
Bow.....57  
Deck.....92  
Dinghy.....15  
Inflatable Boat.....15  
Mast.....92  
Pole.....92  
Skene.....57  
Stainless Steel.....57

**Circuit Breaker Panels**.....290  
**Circuit Breakers**.....291  
**Cleaners**  
All Purpose.....201  
Blige.....204  
Black Streak Removers.....201  
Boat Washes & Soaps.....201  
Bottom.....200  
Cleaning Tools.....206  
Deck.....201, 203  
Fabric.....200, 205  
Fender.....60  
Head Odor.....109  
Hull & Bottom.....200  
Inflatable Boats.....9  
Metal.....204  
Mildew.....200  
Paint.....211  
Plastic.....205  
Restorers & Compounds.....202  
Stain Removers.....200-201, 205  
Stainless Steel.....204  
Strataglass.....205  
Teak.....216  
Vinyl.....200, 205

**Clear Seal Wire Connectors**.....293

**Cleats**  
Cam.....74, 78  
Clam.....78  
Clutches.....79  
Deck.....57, 92  
Dock.....57, 63  
Fender.....59  
Jam.....78  
Shroud.....91  
Stainless Steel.....57  
Toe Rail.....57

**Clevis Pins**.....90  
**Clinometers**.....93  
**Clocks**.....139

**Clothing**  
Boots.....155-156  
Coveralls.....160, 207  
Drysuits.....154, 160  
Gloves.....155, 157  
Hats.....157  
Jackets Men's.....154  
Jackets Women's.....155  
Protective.....207  
Rash Guards/UV.....154-155  
Shoes Men's.....155-156  
Shoes Women's.....156  
Shorts.....154  
Socks.....157  
Sunglasses.....157  
Trousers Men's.....154  
Trousers Women's.....155

**C-Map Charts**.....257  
**Cobra Marine VHF Radios**.....240, 245  
**Cockpit Chairs**.....184-185  
**Cockpit Steps**.....61  
**Cockpit Tables**.....182  
**ColdMachine**.....132

**Cole Hersee**  
Inline Fuse Holder.....292  
Switches.....279, 291-292  
Terminal Blocks.....292

**Collinite Waxes**.....203-205  
**Compasses**.....226-227  
**Condensing Units**.....132  
**Connectors**  
Chain.....45  
Electrical.....281-283, 293, 295  
Fuel.....23  
Gas Grill.....125  
Hose.....110, 112

**Consoles**  
Covers.....180  
Inflatable Boats.....12  
Jockey.....12  
Kore.....198

**Control Arms & Cables**.....35  
**Cooking Fuel**.....127, 143, 195  
**Cooktops**.....127-128  
**Cookware**.....134  
**Coolers**.....182  
**Copper Foil**.....235  
**Cordage**.....See Line  
**Cordsets**.....281-283  
**CoreMat**.....198  
**Corrosion Protection**.....204  
**Cotter Pins & Rings**.....90, 178

**Covers**  
BBQ.....122-123  
Boat.....4, 7, 219  
Boat Support Poles.....219  
Cable.....91, 275  
Console.....180  
Fender.....58-60  
Outboard Motor.....22  
Seat.....180, 183  
Turnbuckle.....93  
Wheel.....38

**Cowl Vents**.....150  
**Crewsaver Life Jackets**.....162-163  
**Cruising Guides**.....222, 229  
**Cup Holders**.....134, 136, 182  
**Curtain Fasteners**.....178

**Cushions**  
Boat.....162  
Fender.....59  
Flotation.....162  
Foam.....175  
Lifeline.....68

**Custom**  
Fender Covers.....60  
Lifelines.....68  
Rigging.....67  
Welcome/Boarding Mats.....60

**D**

**Dahon Bikes**.....152  
**Danforth Anchors**.....49  
**Davis**  
Bags.....137  
Boat Hooks.....181  
Compasses.....227  
Mega-Lights.....299  
Plotting Tools.....223  
Quick Reference Rules.....223  
Radar Reflectors.....172  
Rigging Knives.....199  
Sextants.....229  
Slick Seam.....191  
Weather Stations.....247  
Wind Indicators.....95, 247

**Davits**.....15-16  
**Deck**  
Antenna Mounts.....231, 236  
Brushes.....206  
Chairs.....183-184  
Chocks.....57, 92  
Cleaners.....201, 203  
Cleats.....57, 63, 92  
Fills.....24  
Floodlights.....301  
Flooring.....175  
Fuel Vents.....24

Hardware.....57, 63  
Hinges.....187  
Organizers.....79  
Pipe.....46  
Plates.....137, 148  
Rail Fittings & Tubing.....187  
Showers.....118-119  
Steel Tubing.....187  
Tables.....183  
Tiles.....175  
Wash Kits.....102

**Deck & Cockpit**.....180-187, 199, 221  
**Deck Seals**.....295  
**Decking & Flooring**.....175  
**Defender Inflatable Boats**.....4, 6, 8  
**Defender Rigging Services**.....66-67  
**Dehumidifiers**.....200  
**De-Icers**.....219  
**Denatured Alcohol**.....143  
**Depth Gauges**.....247, 249-250

**Detectors**  
Fume & CO.....174  
Gas.....124  
Smoke and Heat.....174

**Dickinson**  
Barbeques & Grills.....123  
BBQ Accessories.....123  
Cabin Heaters.....143  
Heater Accessories.....143  
Ranges.....127

**Digital Yacht**  
AIS Systems.....239  
GPS Sensors.....259  
WiFi Solutions.....248  
Wind Systems.....256

**Dinghy**.....2-8  
**Dinghy Accessories**  
See Inflatable Boat  
Parts & Accessories

**Dinnerware**.....135  
**Director Chairs**.....183  
**Dirt Devil Vacuum Cleaners**.....129  
**Dishracks**.....134  
**Distress Signal Flags**.....138  
**Ditch Bags**.....169

**Dock**  
Boxes.....63  
Bumpers.....62  
Carts.....63  
Ladders.....61  
Lighting.....301-302, 308  
Lines.....43-44  
Lockers.....63  
Mooring Whips.....63  
Rub Rails.....62  
Steps.....61

**Dock Edge Cleats**.....63  
**DockCatcher**.....63  
**Doelfin Hydrofoils**.....41  
**Dollies**.....16

**Dometic**  
A/C Kits.....140  
Air Filters.....142  
Air Purifiers.....142  
Cabin Heaters.....143  
Deodorants.....109  
Float Switches.....110  
Head Accessories.....105  
Heads.....104, 107  
Holding Tanks.....108-109  
Pumps.....108  
Refrigeration.....132  
Sanitation Hose.....114  
Tank Monitors.....110  
Valves.....105

**Door Bolts/Latches**.....188-189  
**Dotline Ladders**.....61

**Dr. LED**  
Chart/Reading Lights.....308  
Dome Lights.....306  
Multi-Purpose Lights.....303  
Replacement Bulbs.....309  
Spotlight, Handheld.....300  
Spreader Lights.....301  
Underwater Lights.....302

**Dr. Shrink Winterizing Products**.....219-220

**Drain Plugs**.....14  
**Drains**.....118, 121  
**Drapery Systems**.....176  
**Drawer Refrigerators**.....130, 133  
**Dri-Dek Flooring**.....175  
**Drink Holders**.....134, 136, 182  
**Drinkware**.....135  
**Drivesaver**.....31  
**Drogues**.....172  
**Dry Boxes**.....167  
**Drysuits**.....154, 160  
**Ducting Materials**.....142, 150  
**DVD Players**.....232  
**DVD's**  
Epoxy How-To.....193  
Navigation.....230

**Dynaplate**.....284  
**DYNEL Fabric**.....196

**E**

**Eartec Wireless Intercom Systems**.....242

**Edson**  
Boarding Steps.....60  
Cockpit Tables.....182  
Control Levers.....39  
Drink Holders.....182  
Instrument Housings & Mounts.....273  
Motor Brackets.....22  
Pedestal Guards.....38  
Pedestal Maintenance Kits.....39  
Portable Pump Kits.....167  
Power Wheel.....40  
PowerKnob.....40  
Radar Towers.....273  
Spreader Boot Kits.....94  
Steering Wheels & Accessories.....38-40  
Table Accessories.....182  
Turnbuckle Covers.....93

**Eldridge Tide & Pilot Book**.....228  
**Electric Outboards**.....21  
**Electrical**.....277-295  
**Electronics**.....231-265, 267-276  
**Embassy Guides**.....222

**Emergency**  
Alarms.....173-174  
Blankets.....169, 174  
Boarding Ladders.....167  
Ditch Bags.....169  
Fire Extinguishers.....174  
First Aid Kits.....171  
Flags.....138  
Flares.....173  
Food.....169  
Hydration.....169  
Paddles.....167  
Pumps.....167  
Radar Reflectors.....172  
Repair Tape.....114  
Rescue Boats.....8  
Rescue Lights.....165  
Rescue Rope.....167  
Signal Mirrors.....165  
Strobe Lights.....165  
Supplies.....169  
Water.....169  
Whistles.....165

**Emergency & Rescue Boats**.....8

**Engine & Fuel Systems**  
2 & 4-Cycle Motor Oil.....25  
Anodes.....35-37  
Control Arms.....34, 38-39  
Control Cables.....35  
Deck Fills.....24  
Engine Care.....24  
Engine Controls.....34  
Engine Lubricants.....25  
Exhaust Fittings.....33  
Exhaust Products.....32  
Fuel Additives.....24-25  
Fuel Conditioning.....25, 30  
Fuel Connectors.....23

- Fuel Filters ..... 20-21, 26  
 Fuel Management ..... 28-30  
 Fuel Polishing ..... 30  
 Fuel Pumps ..... 24  
 Fuel Separators ..... 24  
 Fuel Tanks ..... 23  
 Fuel/Air Separators ..... 26  
 Fuel/Water Separators ..... 26  
 Gauges ..... 28-29  
 Heat Exchangers ..... 30  
 Hourmeters ..... 29  
 Hydrofoils ..... 41  
 Impellers ..... 31  
 Line Cutters ..... 34  
 Motor Flushers ..... 27  
 Mufflers & Fittings ..... 33  
 Oil Absorbers ..... 27  
 Oil Changers ..... 27  
 Packing & Tools ..... 30  
 Propellers ..... 34  
 Pumps, Engine Cooling ..... 31  
 Sending Units ..... 29  
 Shaft Shark ..... 34  
 Smart Tabs ..... 41  
 Soundproofers ..... 33  
 Spark Plugs ..... 19-21, 24  
 Steering Systems & Controls ..... 40  
 Steering Wheels ..... 40  
 Thrusters ..... 42  
 Trim Tabs ..... 41  
 Water Separators ..... 24  
 Water Strainers ..... 32  
 Wiper Arms, Blades & Motors ..... 221  
 Zincs ..... 36-37
- Engine Controls & Cables** ..... 34  
**Engine Lubricants** ..... 25  
**Engine Shutdown Alarms** ..... 173-174  
**ENØ Cooktops & Stoves** ..... 126-127  
**Ensigns** ..... 138  
**Epifanes**  
 Thinners ..... 214  
 Varnishes ..... 214  
**EPIRBs** ..... 166  
**Epoxies & Resins** ..... 192-195, 197,  
 208-209, 211, 215, 217  
**Evaporators** ..... 131-132  
**Evercoat** ..... 194-195  
**Evinrude/Johnson  
 Outboard Parts & Accessories**  
 ..... 8, 21, 24  
**Exhaust Fittings** ..... 32-33  
**Exhaust Flappers** ..... 33  
**Eye Bolts** ..... 57  
**Eye Straps** ..... 189  
**E-Zorb** ..... 25
- F**
- Fabrics**  
 Boat Repair ..... 196  
 Canvas Cloth ..... 176  
 Cleaners ..... 200, 205  
 Drapery Systems ..... 176  
 Dynel ..... 196  
 Fasteners ..... 178  
 Fiberglass ..... 196-197  
 Graphite Cloth ..... 196  
 Headliner ..... 180  
 Hypalon ..... 13  
 KÉVLAR ..... 196  
 Laminates ..... 196  
 Naugahyde/Seaquest ..... 176  
 Netting, Nylon ..... 149  
 Polyester ..... 196  
 PVC ..... 13  
 Sumbrella ..... 176  
 Upholstery ..... 176  
 Vinyl ..... 180  
**Fairing Compounds** ..... 209  
**Fans** ..... 149  
**Faria Marine Gauges** ..... 29, 249  
**Fasteners** ..... 178  
**Faucets** ..... 118-120  
**Fenders & Accessories** ..... 58-60  
**Fiamm Horns** ..... 170
- Fiberglass**  
 Cleaners ..... 201, 204  
 Cloth ..... 196  
 Fabric ..... 196-197  
 G10 Board ..... 198  
 Matting ..... 196  
 Tape ..... 197  
 Wet Exhaust Tubing ..... 32
- Fillers**  
 Bulk 193  
 Epoxy ..... 193, 211  
 Resin ..... 192-193, 195
- Filters**  
 Fuel ..... 20-21, 26  
 Holding Tank ..... 109  
 Oil ..... 19-20  
 Vacuum Gauges ..... 26  
 Water ..... 115
- Fire Blankets** ..... 174  
**Fire Extinguishers** ..... 174  
**Fireboy**  
 Fire Extinguishers ..... 174  
 Fume & CO Detectors ..... 174  
 Propane Detectors ..... 124  
 Tank Monitors ..... 110
- First Aid Kits** ..... 171
- Fishfinders**  
 CHIRP Sonar 258, 260-261, 263-264  
 FishTrax Portable ..... 247  
 Furuno ..... 270-271  
 Lowrance ..... 263-264  
 Raymarine ..... 260-261  
 Si-Tex ..... 267
- Fishing Tables** ..... 122  
**Fittings, Plumbing** ..... 110-113, 117  
**Flags, Poles & Accessories** ..... 15, 138  
**Flares** ..... 173  
**Flatware** ..... 135  
**FLIR Thermal Imaging Night Vision**  
 ..... 261
- Float Coats** ..... 161  
**Float Switches** ..... 98-99, 102  
**Flojet Pumps** ..... 100, 118  
**Floodlights** ..... 301  
**Flooring & Decking** ..... 175  
**Fluid Extractors** ..... 27  
**Fluxgate Compasses**  
 ..... 250-251, 253, 255, 271
- Foam**  
 Closed-Cell ..... 197  
 Cushion ..... 175  
 Mattress ..... 175  
 Open-Cell ..... 175  
 Polyurethane ..... 197  
 Pour-In-Place ..... 197  
 Soundproofing ..... 33
- Fogging Oil** ..... 24  
**Folding**  
 Anchors ..... 49  
 Chairs ..... 183  
 Cleats ..... 57  
 Mast Steps ..... 94  
 Tables ..... 182-183
- Foot Pumps** ..... 121  
**Force 10 Ranges & Stoves** ..... 126-127
- Forespar**  
 Awning Poles ..... 180  
 Cleats ..... 92  
 Davits ..... 16  
 Deodorizers ..... 200  
 Lanocote ..... 9, 204  
 Lightning Dissipators ..... 94, 235  
 Marine Labels ..... 190  
 Mast & Track Fittings ..... 92  
 MOB Poles ..... 168  
 Motor Lifts ..... 22  
 Navigation Lights ..... 298  
 Plumbing Fittings ..... 111-112  
 Pole Chocks ..... 92  
 Pole Storage ..... 92  
 Ring Buoy Holders ..... 167  
 Sink Wastes ..... 121  
 Strainers ..... 32  
 Tea Tree ..... 200  
 Thru-Hull Plugs ..... 112
- Thru-Hulls ..... 111  
 Tiller Extensions ..... 39  
 Vented Loops ..... 110  
 Water Filters ..... 115  
 Whisker Poles ..... 92  
 Winches ..... 83  
 Yacht Rods ..... 85
- Forte Anchor & Spinnaker Poles** 92  
**Fortress Anchors** ..... 49  
**Foul Weather Gear** ..... 154  
**Freezers** ..... 130, 132-133
- Fuel**  
 Additives ..... 24-25  
 Caddy ..... 23  
 Conditioners ..... 25, 30  
 Connectors ..... 23  
 Filters ..... 20-21, 26  
 Gauges ..... 28-29  
 Hose ..... 24  
 Lines ..... 23  
 Management ..... 28-30  
 Monitoring Systems ..... 28  
 Polishes ..... 30  
 Products ..... 24  
 Pumps ..... 24  
 Sender Kits ..... 23  
 Separators ..... 24, 26  
 Tank Cleaners ..... 30  
 Tanks ..... 19-21, 23  
 Treatments ..... 25  
 Whistle ..... 24
- Fujinon Binoculars** ..... 225  
**Full Throttle Life Jackets** ..... 159  
**Fulton Trailer Products** ..... 17-18  
**Fume & CO Detectors** ..... 124, 174  
**Furlers** ..... 86-87  
**Furling Blocks** ..... 86  
**Furling Ties** ..... 91  
**Furion Shore Power** ..... 281  
**Furuno**  
 AIS Systems ..... 238, 271  
 Autopilots ..... 251  
 Chartplotter/Sounders ..... 270-271  
 Fishfinders ..... 270-271  
 GPS Navigator ..... 270  
 Heading Sensors ..... 271  
 Instruments, FI-70 Series ..... 249  
 Multifunction Displays ..... 270  
 NAVnet ..... 270  
 Networking Accessories ..... 271  
 Radars ..... 270-271  
 Radios ..... 270  
 Transducers ..... 271  
 Weather Receivers ..... 247, 271
- Fuse Blocks** ..... 292  
**Fuses** ..... 292  
**Fusion Marine Stereos & Speakers**  
 ..... 232
- G**
- Galleyware** ..... 134-135  
**Galvanic Isolators** ..... 284  
**GAM Electronics Antennas** ..... 236  
**Garelick**  
 Chairs ..... 183  
 Dollies ..... 16  
 Motor Brackets ..... 22  
 Motor Caddies ..... 22  
 Portagers ..... 22  
 Steps ..... 61  
 Swim Platforms ..... 61  
 Tables ..... 183
- Gas**  
 Detection Systems ..... 124  
 Hose & Connectors ..... 125  
 Lockers & Tanks ..... 124  
**Gas Caddy** ..... 23  
**Gas Springs** ..... 189  
**Gasket**  
 Hatch ..... 151  
 Port ..... 145, 151
- Gauges** ..... 28-29  
**Gauges, Multifunction** ..... 249-250  
**Gel Coats** ..... 194-195
- Gill**  
 Bags ..... 158  
 Boots ..... 155  
 Clothing ..... 154-155  
 Drysuits ..... 154  
 Gloves ..... 155, 157  
 Hats ..... 157  
 Jackets Men's ..... 154  
 Jackets Women's ..... 155  
 Knives ..... 164  
 Rash Guards ..... 154  
 Shoes ..... 155-156  
 Socks ..... 157  
 Sunglasses ..... 157  
 Trousers Men's ..... 154  
 Trousers Women's ..... 155  
 Watches ..... 158
- Git Rot** ..... 215  
**Glasses** ..... 135  
**Globe**  
 Impellers ..... 31  
 The Drivesaver ..... 31
- Glomex Antennas** ..... 236  
**Gloves** ..... 155, 157, 161  
**Go Power!**  
 Battery Chargers ..... 288  
 Inverters ..... 288  
 Solar Panels ..... 289
- Golight Searchlights & Spotlight**  
 ..... 300  
**Gori Propellers** ..... 34  
**GPS**  
 Antennas ..... 230, 265  
 Chartplotters ..... 261, 263-264,  
 267, 270-271  
 Handheld Mounts ..... 273  
 Navigator ..... 270  
 Sensors ..... 230, 245, 259
- Graphite Cloth** ..... 196  
**Grills** ..... 122-123  
 CNG ..... 122  
 Connectors ..... 125  
 Covers ..... 122  
 Grill Accessories ..... 122-123  
 Hose ..... 125  
 Regulators ..... 125
- Groco**  
 Deck Wash Kits ..... 102  
 Filters ..... 26  
 Head Accessories ..... 105  
 Heads ..... 104, 107  
 Motor Flushers ..... 27  
 Pumps ..... 102, 108  
 Seacocks ..... 111  
 Service Kits ..... 105  
 Strainers ..... 32, 111  
 Thru-Hulls ..... 111  
 Vented Loops ..... 110  
 Water Pumps ..... 101
- Grommet Kits** ..... 178  
**Grounding Plates** ..... 235, 284  
**Guest / Maringo**  
 Battery Chargers ..... 285  
 Battery Switches ..... 279  
 Fans ..... 149
- Gull Sweeps** ..... 181  
**Gunnel Guard** ..... 62
- H**
- Hailer Horns** ..... 235, 243-245, 270  
**Halogen**  
 Docking Lights ..... 308  
 Floodlights ..... 301  
 Mast Lights ..... 298  
 Navigation Lights ..... 296  
 Reading / Chart Lights ..... 308  
 Spotlights ..... 300
- Halyard**  
 Jib Restrainers ..... 86  
 Lead Blocks ..... 75
- Halyards**  
 Flag ..... 138  
 Jib ..... 66  
 Pre-Spliced ..... 66  
 Spinnaker ..... 66
- Wire-To-Rope ..... 66  
**Hand Pumps** ..... 121  
**Hand Rails** ..... 136, 187  
**Handles** ..... 188  
**Hardeners** ..... 192  
**Hardware**  
 Clamps & Clips ..... 137  
 Deck ..... 57, 63  
 Fabric Fasteners ..... 178  
 Handles & Hinges ..... 187-188  
 Lashing Hooks ..... 137  
 Latches ..... 189  
 Lifeline ..... 69  
 Locks ..... 189  
 Pedestals, Seat ..... 185  
 Rail ..... 187  
 Rigging ..... 67-68, 70  
 U-Bolts ..... 189
- Harken**  
 Blocks ..... 72-73  
 Bosun's Chairs ..... 94  
 Cam Cleats & Bases ..... 78  
 Cars & Stops ..... 89  
 Control Blocks ..... 89  
 Furling Blocks ..... 86  
 Furling Systems ..... 86  
 Lazy Jacks ..... 93  
 Padeyes ..... 77  
 Pivot Lead Blocks ..... 78  
 Track ..... 89  
 Travelers & Cars ..... 89  
 Winch Handles ..... 84  
 Winches ..... 83
- Harnesses** ..... 164  
**Hatch**  
 Accessories ..... 146-149, 151, 188  
 Deck Plates ..... 148  
 Dogs ..... 148  
 Gasket Material ..... 151  
 Hinges ..... 148  
 Screens ..... 146-147, 149  
 Shades ..... 147  
 Tape ..... 148, 151  
 Trim ..... 147, 188  
 Umbrellas ..... 149
- Hatches** ..... 146-148  
**Hats** ..... 157  
**Hawse Pipe** ..... 46  
**Hayn**  
 Lifeline & Rigging Hardware .....  
 67-68, 70  
 Shackles ..... 80
- Head Service Kits** ..... 105  
**Heading Sensors** ..... 251, 253,  
 255, 265, 271  
**Headliner** ..... 180  
**Heads**  
 Accessories ..... 105  
 Chemicals ..... 109  
 Conversion Kits ..... 103-105  
 Electric ..... 106-107  
 Hose ..... 105, 114  
 Macerator Pumps ..... 108  
 Manual ..... 103-104  
 Portable ..... 104  
 Self-Contained ..... 104  
 Toilet Paper & Holders ..... 109
- Heat**  
 Exchangers ..... 30  
 Guns ..... 220
- Heat Shrink** ..... 293  
**Heater Craft Heaters** ..... 143  
**Heaters**  
 Alcohol ..... 143  
 Cabin ..... 140, 143  
 Diesel ..... 143  
 Electric ..... 143  
 Engine/Bilge ..... 143  
 Installation Kits ..... 140  
 Propane ..... 143  
 Solid Fuel ..... 143
- Hella Marine**  
 All-Round Lights ..... 297  
 Courtesy Lights, LED ..... 304-305  
 Docking Lights ..... 301



- Fans ..... 149  
 Floodlights ..... 301  
 Interior Lights ..... 305  
 Multi-Purpose Lights ..... 301, 303  
 Navigation Lights ..... 297  
 Reading/Chart Lights ..... 308  
 Search Lights ..... 300  
 Strip Lights ..... 303
- Hinges** ..... 187-188
- Holders**  
 Binocular ..... 136, 225  
 Buoys ..... 167  
 Cup/Drink ..... 134, 182  
 Fender ..... 58-60  
 Handheld Gear ..... 134, 256  
 Inflatable Boat ..... 15-16  
 Rod ..... 186  
 Toilet Paper ..... 109  
 Winch Handle ..... 84
- Holding Tanks**  
 Chemicals, Treatments ..... 109  
 Filters ..... 109
- Honda**  
 Fuel Tanks ..... 19  
 Maintenance Parts ..... 19  
 Outboard Engines ..... 19  
 Outboard Parts & Accessories ..... 19, 24-25
- Honda Powered Boat Packages** ..... 19
- Hook & Loop** ..... 177
- Hooks**  
 Boat ..... 181  
 Coat ..... 137  
 Lashing ..... 137  
 Sails ..... 91  
 Snap ..... 72, 190  
 Snubber ..... 45
- Horns** ..... 170
- Hailers** ..... 235, 243-245, 270
- Horseshoe Buoys** ..... 167-168
- Hose**  
 A/C ..... 142  
 Adapters, Pipe-and-Hose ..... 111-112  
 Air Vent ..... 142, 150  
 Barb ..... 23  
 Bilge ..... 114  
 Blower ..... 150  
 Clamps ..... 32, 114  
 Connectors ..... 110, 112  
 Corrugated ..... 114  
 Exhaust ..... 32  
 Fill & Feed ..... 24  
 Fittings ..... 110, 112  
 Flanges ..... 150  
 Fuel ..... 24  
 Gas Grill ..... 125  
 General Purpose ..... 114  
 Head ..... 105, 114  
 Heater ..... 114, 142, 150  
 Hump ..... 32  
 Livewell ..... 114  
 LPG ..... 125  
 Potable Water ..... 205  
 PVC ..... 114  
 Rubber ..... 105, 114  
 Sanitation ..... 105, 114  
 Steering ..... 40  
 Tape, Emergency Repair ..... 114  
 Thru-Hull ..... 111  
 Trident ..... 32  
 Vents ..... 24, 150  
 Water ..... 205
- Hourmeters** ..... 29
- Housings & Mounts** ..... 256, 273-276
- Hull Plugs** ..... 111
- Hydraulic Steering** ..... 40, 251-255
- Hydrofoils** ..... 41
- HyperVent** ..... 175
- I**  
**i2Systems Lighting** ..... 304-305, 307
- Ice Eaters** ..... 219
- Ice Makers** ..... 129
- ICOM**  
 AIS Systems ..... 239
- Hailers ..... 243  
 SSB ..... 235  
 VHF's, Fixed Mount ..... 243  
 VHF's, Handheld ..... 242
- IGLOO Coolers & Accessories** ..... 182
- Immersion Suits** ..... 160, 162-163
- Impellers** ..... 31
- Imtra**  
 Access Hatches ..... 148  
 Faucets ..... 119-120  
 LED Lights ..... 303, 305  
 Reading Lights ..... 308  
 Replacement Bulbs ..... 309  
 Thrusters ..... 42  
 Windlass Accessories ..... 56  
 Wiper Arms, Blades & Motors ..... 221  
 Wiper Switches ..... 221
- Inclinometers** ..... 93
- Inflatable Boat Parts & Accessories**  
 Achilles ..... 5, 11  
 Adhesives ..... 13  
 Air Floors ..... 12  
 Air Pumps ..... 10  
 Air Valves ..... 14  
 Anchor Kits ..... 49  
 Bags, RIB Storage ..... 2, 7, 12  
 Boarding Steps ..... 14  
 Boat Covers ..... 4, 7, 9  
 Boat Paint ..... 9, 13  
 Bombard ..... 11  
 Chocks ..... 15  
 Cleaners ..... 9  
 Consoles ..... 12  
 Davits ..... 15-16  
 Defender ..... 11-12  
 Dinghy Tow Rope ..... 17, 152  
 Dollies ..... 16  
 Drain Plugs ..... 14  
 Hoist Systems ..... 16-17  
 Inflators/Deflators ..... 10  
 KeelGuard ..... 4  
 Ladders & Steps ..... 14  
 Launching Wheels ..... 16  
 Letters & Numbers ..... 190  
 Lifting Slings ..... 17  
 Maintenance ..... 9, 13, 17  
 Mercury ..... 7, 11  
 Motor Brackets ..... 22  
 Motor Locks ..... 22  
 Motor Transport ..... 22  
 Navigation Lights ..... 299  
 Oars & Oarlocks ..... 11  
 Paddles ..... 11  
 Pumps ..... 7, 10  
 Quicksilver ..... 7, 11  
 Rack Systems ..... 15  
 Registration Products ..... 15  
 Repair Fabric ..... 13  
 Repair Kits ..... 2, 7, 13  
 Seats ..... 12  
 Shade Tops ..... 180  
 Smart Tabs ..... 41  
 Storage ..... 2, 7, 12, 22  
 Strap Handles ..... 14  
 Tie-Downs & Handles ..... 14  
 Tow Rope ..... 17  
 Towables & Tubes ..... 152  
 Towing Bridles ..... 17  
 Trailer Products ..... 18  
 Transom Pads ..... 22  
 Waterski Tow Rope ..... 152  
 Watersports ..... 152  
 Zodiac ..... 2, 11
- Inflatable Boats**  
 AB ..... 4, 6  
 Achilles ..... 5-6, 8  
 Defender ..... 4, 6, 8  
 Emergency & Rescue Boats ..... 8  
 Mercury ..... 7-8  
 Rugged Inflatables ..... 6  
 Zodiac ..... 2-3, 8
- Instruments**  
 Autopilots ..... 249, 252, 254  
 B&G ..... 249, 254  
 Depth ..... 246-247, 249-250
- Furuno ..... 249  
 Housings & Mounts ..... 256, 273-276  
 Raymarine ..... 246, 250, 252  
 Simrad ..... 249, 254  
 Speed ..... 249-250  
 Wind ..... 247, 249-250, 256
- Insulation** ..... 33
- Intercoms, Wireless** ..... 242-243
- Interlux**  
 Anti-Fouling ..... 210-211  
 Barrier System ..... 211  
 Bilge Paints ..... 213  
 Bottom Paints ..... 210  
 InterProtect ..... 211  
 Micron ..... 210  
 Non-Skid Paints ..... 213  
 Paints ..... 210-211, 213  
 Primers ..... 211, 213  
 Solvents ..... 211  
 Strippers ..... 211  
 Surface Prep ..... 211, 213  
 Topside Paints ..... 213  
 Varnishes ..... 214
- Internet Interface** ..... 259, 262-264
- Internet Systems** ..... 248
- Inverters** ..... 286-287
- Inverters/Chargers** ..... 286
- Isotemp Water Heaters** ..... 116
- Isotherm**  
 Ice Makers ..... 129  
 Refrigerators ..... 130-131  
 Travel Boxes ..... 131
- J**  
**Jabco**  
 A/C Pumps ..... 141  
 Accumulator Tanks ..... 102  
 Baitwell Pumps ..... 101  
 Bilge Pumps, Electric ..... 98, 118  
 Blowers ..... 150  
 Heads, Electric ..... 107  
 Heads, Manual ..... 103  
 Impellers ..... 31, 105  
 Macerator Pumps ..... 108  
 Oil Changers ..... 27  
 Plumbing Fittings ..... 112  
 Pumps ..... 31, 98, 100-102, 105, 108, 118, 141  
 Service Kits ..... 105  
 Toilet Seats ..... 105  
 Valves ..... 105  
 Washdown Pumps ..... 102  
 Water Pumps ..... 31, 100-101  
 Water Systems ..... 100
- Jack Stands** ..... 220
- Jacklines** ..... 164
- Jim Buoy**  
 Dock Bumpers ..... 62  
 Horseshoe Buoys ..... 167  
 MOB Poles ..... 168  
 Mooring Buoys ..... 47  
 Ring Buoys ..... 167
- Jockey Consoles** ..... 12
- Johnson Pump**  
 Bilge Pumps, Automatic ..... 97  
 Bilge Pumps, Electric ..... 99  
 Heads ..... 104  
 Pumps, Macerator ..... 108  
 Pumps, Shower Sump ..... 118  
 Switches ..... 99  
 Washdown Pumps ..... 102  
 Water Pumps ..... 31, 101
- Jonbuoy MOB Products** ..... 168
- Junction Boxes** ..... 250, 295
- K**  
**Kayak Compasses** ..... 227
- KeelGuard** ..... 4
- Kent**  
 Immersion Suits ..... 162  
 Life Jackets ..... 162  
 Rescue Bags ..... 167
- Kenyon Cooktops & Burners** ..... 128
- KEVLAR 49 Fabric** ..... 196
- Key Floats** ..... 165
- Kingston**  
 Anchor Rollers ..... 50  
 Anchors ..... 49  
 Davits ..... 16
- Kitty Hair** ..... 195
- KiwiGrip Non-Skid Coating** ..... 212
- Knives** ..... 164, 186, 199
- Knobs, Steering/Throttle** ..... 34
- KUUMA**  
 Barbeques & Grills ..... 123  
 BBQ Accessories ..... 123  
 Coolers ..... 182  
 Water Heaters ..... 116
- KVH**  
 Satellite TV Systems ..... 237  
 TracPhone ..... 248  
 TracVision ..... 237
- L**  
**Labels & Placards** ..... 190
- Ladders & Accessories** ..... 60-61  
 Boarding ..... 60  
 Emergency Boarding ..... 167  
 Folding ..... 14, 60  
 Platforms ..... 61  
 Steps ..... 14, 60-61
- Lamps**  
 Bulkhead ..... 303  
 Cabin ..... 307-308  
 Oil ..... 307  
 Table ..... 307  
 Yacht ..... 307
- Lap Links** ..... 45
- Lash-It** ..... 188-189
- Latches** ..... 188-189
- Launching Dollies** ..... 16
- Lazy Jack Kits** ..... 93
- Leaning Posts** ..... 185
- LED Lighting** ..... 18, 296-309
- Lee Cloth** ..... 175
- Lenco Trim Tabs** ..... 41
- Lewmar**  
 Anchor Rollers ..... 50  
 Anchors ..... 48  
 Blocks ..... 71, 84  
 Bow Rollers ..... 50  
 Cockpit Tables ..... 182  
 Deck Organizers ..... 79  
 Genoa Lead Systems ..... 88  
 Hatch Accessories ..... 148  
 Hatches & Screens ..... 147  
 Portlights ..... 144  
 Rope Clutches ..... 79  
 Rope/Chain Rodes ..... 44  
 Steering Accessories ..... 39  
 Steering Wheels ..... 38, 40  
 Thrusters ..... 42  
 Travelers ..... 89  
 Trim ..... 147  
 Winch Handles ..... 84  
 Winch Maintenance ..... 83  
 Winches ..... 82  
 Windlasses & Accessories ..... 52-53
- Life-Calk** ..... 191
- Lifelines**  
 Cushions ..... 68  
 Gate Eyes & Hooks ..... 69  
 Hardware ..... 69  
 Kits ..... 69  
 Pelican Hooks ..... 68-69  
 Stanchions ..... 69  
 Toggle Jaws ..... 68-70  
 Turnbuckles ..... 68-69  
 Wire ..... 68
- Liferafes** ..... 169
- Lifeworlds**  
 Adults ..... 159-163  
 Children ..... 159, 161-162  
 Pets ..... 162
- Lift Rings** ..... 188
- Lighting**  
 All-Round ..... 296-299  
 Bi-Color ..... 296-299  
 Bulbs, Replacement ..... 298-299, 309  
 Bulkhead ..... 303
- Cabin Lights ..... 305-308  
 Ceiling ..... 304-306  
 Chart ..... 308  
 Courtesy Lights ..... 304, 306  
 Deck Lighting ..... 301, 308  
 Docking ..... 299, 301-302, 308  
 Dome Lights ..... 304-306  
 Emergency ..... 165, 173  
 Floodlights ..... 300-301  
 Halogen ..... 296, 298, 300-301, 308  
 Incandescent ..... 296-298  
 Interior ..... 303-308  
 Lamps ..... 307-308  
 LED Lights ..... 18, 296-309  
 Masthead ..... 296-299  
 Multi-Purpose Lights ..... 303  
 Navigation Lights ..... 296-299  
 Portable ..... 299  
 Reading/Chart Lights ..... 307-308  
 Recessed ..... 304-306  
 Replacement Bulbs ..... 298-299, 309  
 Running Lights ..... 297-298, 309  
 Searchlights ..... 300  
 Sensibulb ..... 309  
 Sidelights ..... 296  
 Solar ..... 299, 308  
 Spotlights ..... 300  
 Spreader Lights ..... 301  
 Stainless Steel ..... 298, 300-301, 304-307  
 Stern ..... 296-299  
 Strip Lamps ..... 303  
 Strobe ..... 165  
 Trailer ..... 18  
 Underwater ..... 302  
 Wall ..... 307
- Lighting, LED**  
 Accent Lights ..... 304-306  
 Cabin Lights ..... 307  
 Courtesy Lights ..... 304-306  
 Deck Lighting ..... 301, 308  
 Dome Lights ..... 304-306  
 Festoon Bulbs ..... 309  
 Floodlights ..... 301  
 Navigation Lights ..... 296-299, 309  
 Reading Lights ..... 307-308  
 Replacement Bulbs ..... 309  
 Running Lights ..... 297-299, 309  
 Sensibulbs ..... 309  
 Solar Lights ..... 299, 308  
 Spotlights ..... 300-301  
 Strip Lights ..... 303  
 Trailer Light Kits ..... 18  
 Underwater Lights ..... 302
- Lightning Dissipators** ..... 94, 235
- Line**  
 3-Strand Nylon ..... 43-44  
 8-Plait ..... 44  
 Anchor Lines ..... 43-44  
 Anchor Rope/Chain Rodes ..... 44  
 Bungee Cords ..... 179  
 Cover Tie-Downs ..... 180  
 Dock Lines ..... 43-44  
 Double Braid ..... 43-44, 64-66, 89  
 Fender ..... 60  
 Floating ..... 17, 65, 180  
 Furler ..... 86-87  
 Halyards, Pre-Made ..... 66  
 Lifeline ..... 69  
 Mooring ..... 47  
 Organizers ..... 59, 63, 137  
 Polypropylene ..... 180  
 Sailboat ..... 64-66  
 Shock Cord & Accessories ..... 179  
 Splicing ..... 66  
 Splicing Tools & Kits ..... 43, 51  
 Sta-Set ..... 64  
 Tow Rope ..... 17, 152  
 Utility ..... 64, 66, 180  
 Vang ..... 85  
 Webbing & Accessories ..... 179  
 Whipping Products ..... 51
- LineCatcher** ..... 63
- Locking Wire** ..... 46
- Locks** ..... 18, 22, 189

- Lofrans Windlasses** ..... 56  
**Log Books** ..... 223  
**Lonseal Flooring & Trim** ..... 175  
**Louvered Vents** ..... 142  
**Louvers & Doors** ..... 136  
**Lowrance**  
Autopilots ..... 254  
Carbon GPS Chartplotter ..... 264  
Fishfinders ..... 263-264  
Hook Series ..... 264  
Multifunction Displays ..... 263-264  
Radars ..... 265  
Sounders ..... 265  
Transducers ..... 263-265  
VHF's, Handheld ..... 245  
WiFi Interface ..... 263-264  
**LPG Hose** ..... 125  
**Lubrication** ..... 204  
**Lug Connectors** ..... 294  
**Lumber, Marine & Teak** ..... 198  
**Lumitec**  
Courtesy Lights ..... 304-306  
Dome Lights ..... 304-306  
Engine Room Lights ..... 303  
Floodlights ..... 301  
Underwater Lights ..... 302
- M**  
**MagicEzy** ..... 195  
**Magma**  
Barbeques & Grills ..... 122  
BBQ Accessories ..... 122  
Boat Stabilizers ..... 63  
Cookware ..... 134  
Fishing Tables ..... 122  
Gas Grill Fittings ..... 124  
**Magnum Energy Inverter/Chargers**  
..... 280, 286  
**Maintenance** ..... 83, 175, 178-179,  
..... 188-220  
**Majestic Global**  
Speakers, Stereo ..... 236  
TVs & Antennas ..... 236  
**Maptech**  
Chartbooks ..... 222  
Embassy Guides ..... 222  
Navigation Software ..... 230  
**March Pumps** ..... 141  
**Maretron** ..... 268  
**Marinco**  
Battery Chargers ..... 285  
Battery Switches ..... 279  
Shore Power ..... 282-283  
Spotlights ..... 300  
Wire Management ..... 295  
**Marine Lumber** ..... 198  
**MAS Epoxies & Resins** ..... 192, 194, 215  
**Mast**  
Boot Tape ..... 90, 94  
Chocks ..... 92  
Exit Plates ..... 93  
Fittings ..... 92  
Lights ..... 296-299  
Mounts ..... 273, 275-276  
Steps ..... 94  
**Mats, Welcome** ..... 60  
**Mattress Foam** ..... 175  
**Maxwell Windlasses** ..... 54-55  
**mazu iPad / mSeries Hardware**  
**System** ..... 243  
**McMurdo Personal AIS** ..... 166  
**MDR**  
All Purpose Cleaners ..... 201  
Damp Away ..... 200  
E-Zorb ..... 25  
Fender Cleaner ..... 60  
Inflatable Boat Paints ..... 9  
Inflatable Cleaner ..... 9  
Stain Removers ..... 201  
Transducer Paints ..... 217  
Water Zorb ..... 25  
Whip-End Dip ..... 51  
Wood Care ..... 216  
**Meguiar's**  
Boat Soaps & Cleaners ..... 9, 201
- Buffing Pads ..... 207  
Plastic Cleaner ..... 205  
Restorers & Compounds ..... 202  
Waxes ..... 203  
**Mercury**  
Fuel Tanks ..... 20  
Inflatable Boat Parts & Accessories  
..... 7, 11-12  
Inflatable Boats ..... 7-8  
Maintenance Parts ..... 20  
Outboard Engines ..... 20  
Outboard Parts & Accessories 7, 20,  
..... 24-25  
Replacement Parts ..... 7, 12, 20  
**Metal Care** ..... 204  
**Microwaves** ..... 129  
**Mildew Products** ..... 200, 205  
**MOB**  
Gear, Safety ..... 166-168  
Modules ..... 168  
Poles ..... 168  
**Moeller**  
Filters ..... 26  
Fuel Lines/Assemblies ..... 23  
Fuel Sender Kits ..... 23  
Fuel Tanks ..... 23  
Fuel/Water Separators ..... 26  
Oil Changers ..... 27  
**Molding** ..... 136  
**Mooring**  
Accessories ..... 45, 47-48, 50-51, 63  
Anchors ..... 48  
Balls ..... 47  
Chain ..... 45  
Pendants ..... 47  
Snubbers ..... 51  
Whips ..... 63  
**Motor**  
Brackets/Mounts ..... 22  
Caddies ..... 22  
Covers ..... 22  
Flushers ..... 27  
Lifts ..... 22  
Locks ..... 22  
Oils ..... 25  
**Motors** ..... See *Outboards*  
**Mounting Solutions - Electronics**  
..... 256, 273-276  
**MP3 Players** ..... 232-234  
**Mufflers & Fittings** ..... 33  
**Multifunction Displays**  
B&G ..... 262  
Furuno ..... 270-271  
Lowrance ..... 263-264  
Raymarine ..... 246, 258, 261  
Simrad ..... 263  
Si-Tex ..... 267  
**Multifunction Gauges** ..... 249-250  
**Mushroom Anchors** ..... 48-49  
**Mustang**  
Bib Pants ..... 161  
Coveralls ..... 160  
Drysuits ..... 160  
Float Coats ..... 161  
Gloves ..... 161  
Immersion Suits ..... 160  
Lifevests ..... 160-161  
PFD's ..... 160-161  
Re-Arm Kits ..... 160  
**m-y wedge Outboard**  
**Motor Supports** ..... 17  
**Myerchin Knives** ..... 164, 199
- N**  
**Naugahyde/Seaqueat** ..... 176  
**NAUTA Flexible Tanks**  
Waste ..... 109  
Water ..... 117  
**Nautilox** ..... 175, 180  
**Navigation** ..... 222-227, 229-230, 246,  
..... 257-258, 260, 262-264, 267, 270  
Binoculars ..... 224-225  
Chartbooks ..... 222  
Compasses ..... 226-227  
Cruising Guides ..... 222, 229
- Digital Charts ..... 230, 260  
Electronic Charts ..... 257  
Embassy Guides ..... 222  
Multifunction Displays ..... 246, 258,  
..... 262-264, 267, 270  
PC Charts ..... 230, 260  
Plotting Tools ..... 223  
Quick Reference Rules ..... 223  
Sextants ..... 229  
Software ..... 230, 260  
Tools ..... 223, 229  
Waterproof Chartbooks ..... 222  
Waterway Guides ..... 229  
**Navigation Lights** ..... 296-299  
**Navionics Charts** ..... 257  
**Navisafe Portable Navigation**  
**Lights** ..... 299  
**NavPod Instrument Housings**  
**& Mounts** ..... 274  
**Needles, Sewing** ..... 177  
**Netting**  
Bug ..... 146, 149  
Safety ..... 172  
**New England Rope**  
3-Strand Nylon ..... 44  
8-Plait ..... 44  
Dinghy Tow Rope ..... 17  
Jib Halyards ..... 66  
Lifeline Wire Replacement ..... 69  
Mooring Pendants ..... 47  
Sailing Line ..... 64  
Splicing Kit ..... 51  
Sta-Set ..... 64  
**Newmar** ..... 284, 295  
**Nicro Vents** ..... 150-151  
**Night Vision Cameras** ..... 261  
**Nikon Binoculars** ..... 224  
**NMEA Cables & Connectors** ..... 268  
**Nobeltec Navigation Software** ..... 230  
**Noise Reduction** ..... 33  
**Non-Skid**  
Additives ..... 209, 213, 217  
Deck Cleaners ..... 203  
Decking ..... 175  
Dinnerware ..... 135  
Flooring ..... 175  
Glasses ..... 135  
Paints ..... 209, 212-213  
**Norcold Refrigerators** ..... 133  
**NorCross**  
FishTrax ..... 247  
Handheld Instruments ..... 247  
**Novabraid** ..... 17, 47, 66  
**Nuova Rade** ..... 14
- O**  
**Oars & Oarlocks** ..... 11  
**Oberdorfer Pumps** ..... 31, 141  
**Oceanair**  
Port Shades ..... 145  
Shades ..... 147  
SKYscreens ..... 146-147  
**Oceanic Systems Stations & Gauges**  
..... 258-259  
**Octopus/Canada Metal Autopilots** ..... 251  
**Odor & Mold Control** ..... 142, 200  
**OGM LED Navigation Lights** ..... 298  
**Oil**  
Absorbers ..... 27  
Changers ..... 27  
Engine ..... 25  
Filters ..... 19-20  
Lamps ..... 307  
Pads ..... 27  
**OMC Dock Boxes** ..... 63  
**Ongaro**  
Drink Holders ..... 134  
Horns ..... 170  
Shift Knobs ..... 34  
Throttle Knobs ..... 34  
Wiper Arms, Blades & Motors ..... 221  
**Onyx Life Jackets** ..... 159, 162  
**Onyzers**  
Deck ..... 79
- Handheld Gear ..... 134  
Interior ..... 137  
Line / Rope ..... 59, 137  
Teak ..... 136  
**Origo Cabin Heaters** ..... 143  
**Orion**  
First Aid Kits ..... 171  
Flares ..... 173  
**Osculati Showers** ..... 119  
**Outdoor Parts & Accessories**  
2 & 4-Cycle Motor Oil ..... 25  
Anodes ..... 19, 35-37  
BRP/Evinrude ..... 8, 21, 24-25  
Control Cables ..... 35  
Engine Controls ..... 34  
Engine Lubricants ..... 25  
Exhaust Fittings ..... 33  
Exhaust Products ..... 32  
Flush Kits ..... 19-20  
Fuel Additives ..... 24-25  
Fuel Filters ..... 26  
Fuel Lines & Connectors ..... 19-20, 23  
Fuel Management ..... 28-29  
Fuel Separators ..... 24  
Fuel Tanks ..... 19-21, 23  
Fuel/Water Separators ..... 26  
Gauges ..... 28-29  
Heat Exchangers ..... 30  
Honda ..... 19, 24-25  
Hydrofoils ..... 41  
Impellers ..... 19, 31  
Inboard Shaft Products ..... 30  
Lifts ..... 22  
Line Cutters ..... 34  
Maintenance Parts ..... 20-21  
Mercury ..... 20, 24-25  
Motor Brackets ..... 22  
Motor Carriers ..... 22  
Motor Covers ..... 22  
Motor Flushers ..... 27  
Motor Locks ..... 22  
Motor Mounts ..... 22  
Mufflers ..... 33  
Oil Absorbers ..... 27  
Oil Changers ..... 27  
Oil Filters ..... 19-20  
Packing Tools ..... 30  
Paint ..... 208, 210-212  
Portagers ..... 22  
Prop Nuts ..... 36-37  
Propellers ..... 19-21, 34  
Repair Kits ..... 19-21  
Shaft Shark ..... 34  
Shut-Off Lanyards ..... 19-21  
Spark Plugs ..... 19-21, 24  
Steering Systems ..... 40  
Storage ..... 22  
Tiller Extensions ..... 22  
Tohatsu ..... 20, 24-25  
Torqeedo ..... 21  
Transom Pads ..... 22  
Water Strainers ..... 32  
Yamaha ..... 20  
Zincs ..... 19, 36-37  
**Outboards**  
BRP/Evinrude ..... 8, 21  
Honda ..... 19  
Mercury ..... 20  
Tohatsu ..... 20  
Torqeedo ..... 21  
Yamaha ..... 20  
**Outrigger Kits** ..... 186  
**Ovens** ..... 126-127
- P**  
**Packing & Tools** ..... 30  
**Paddles**  
Emergency ..... 167  
Plastic ..... 11  
Varnished Wood ..... 11  
**Padeyes** ..... 77  
**Padlocks** ..... 189  
**Paints**  
Ablatives ..... 208, 210, 212  
Accessories ..... 193, 207, 217-218
- Anti-Fouling ..... 208, 210-213, 217  
Bilge ..... 209, 213  
Bottom ..... 208, 210, 212  
Brushes ..... 218  
Cleaners ..... 211  
Fiberglass ..... 210  
Fillers ..... 211  
Hard ..... 208, 210  
Inflatable Boat ..... 9, 13  
Interior ..... 209  
Masking Tape ..... 218  
Non-Skid ..... 209, 212-213  
Outboard ..... 210-212  
Paint Mixers ..... 218  
Primers ..... 208-209,  
..... 211-213, 215, 217  
Propeller ..... 208, 210-211, 213  
Protective Clothing ..... 207  
Reducers ..... 217  
Removers ..... 211  
Respirators ..... 207  
Restorers & Compounds ..... 202  
Rollers ..... 193, 202, 218  
Sealers ..... 191, 216  
Solvents ..... 195, 211, 217  
Strippers ..... 211  
Thinners ..... 209, 211, 214  
Topside ..... 209, 213, 217  
Transducer ..... 217  
Undercoaters ..... 209  
Water-Based ..... 208-210, 212  
**Panel Meters** ..... 290  
**Panels**  
AC/DC ..... 290  
Thruster Control ..... 42  
**Paneltronics** ..... 290  
**PDQ WiFi Kits** ..... 248  
**Pedestal**  
Break Knobs ..... 39  
Chairs ..... 184-185  
Guards ..... 38  
Hardware ..... 185  
Maintenance Kits ..... 39  
Rebuild Kits ..... 39  
**Peel Away Paint Removers** ..... 211  
**Perimeter**  
Bumpers & Gunnel Guard ..... 62  
Spreader Boots ..... 94  
**Perko**  
All-Round Lights ..... 297  
Latches ..... 188  
Rod Holders ..... 186  
Stern Lights ..... 297  
**Pettit**  
Ablatives ..... 208  
Anti-Fouling Paint ..... 208  
Bottom Paints ..... 208  
Hard Epoxies ..... 195, 209  
Inflatable Boat Paints ..... 9  
Pettit Protect ..... 209  
Primers ..... 208-209  
Surface Prep ..... 209  
Thinners ..... 209  
Topside Paints ..... 209  
Undercoaters ..... 209  
Varnishes ..... 215  
**PFD's**  
Adults ..... 159-163  
Children ..... 159, 161-162  
Pets ..... 162  
**Phone Cordsets** ..... 281, 283  
**Pipe-And-Hose-Adapters** ..... 111-112  
**Placards** ..... 190  
**Plastimo**  
Anchoring Accessories ..... 51  
Bilge Pumps ..... 96  
Bumper Dock Fenders ..... 62  
Compasses ..... 227  
Fender Ladder ..... 60  
Harnesses ..... 164  
Radar Reflectors ..... 172  
Rescue Slings ..... 168  
Water Tanks ..... 117  
**PLBs** ..... 166



- Plotting Gear**  
 Plotting Tools ..... 223  
 Sextants ..... 229
- Plugs**  
 12 VDC ..... 281-283  
 Drain ..... 14  
 Electrical ..... 281-283  
 Emergency ..... 111  
 Teak ..... 136  
 Thru-Hull ..... 111
- Plumbing** ..... 96-121
- Plumbing Fittings** ..... 110-113, 117
- Poles**  
 Awning ..... 180  
 Boat Hooks ..... 181  
 Chocks ..... 92  
 Flag ..... 138  
 MOB ..... 168  
 Spinnaker ..... 92  
 Storage ..... 92  
 Whisker ..... 92
- Poli Glow** ..... 202
- Polish**  
 Aluminum ..... 204  
 Chrome ..... 204  
 Fiberglass & Paint ..... 202-203  
 Hull ..... 200  
 Metal ..... 204  
 Plastic ..... 205  
 Stainless Steel ..... 204
- Polishing Products** 200, 202-205, 207
- Polyform**  
 Buoy ..... 47, 58  
 Fender Covers ..... 58  
 Fenders & Accessories ..... 58
- Poly-Planar Stereos & Speakers** ..... 234-235
- Polypropylene Cordage** ..... 180
- Poppits** ..... 220
- Port Gasket Material** ..... 145, 151
- Porta Potti** ..... 104
- Portagers** ..... 22
- Portlights / Portholes** ..... 144-145
- Ports & Accessories** ..... 144-145
- Potable Water Tanks** ..... 117
- Pots & Pans** ..... 134
- Power Conditioners** ..... 284
- Power Cords** ..... 281-283
- Power Knob** ..... 40
- Primers** ..... 208-209, 211-213, 215, 217
- Profurl Furling Systems** ..... 87
- ProMariner**  
 Battery Chargers ..... 285  
 Galvanic Isolators ..... 284  
 Inverters ..... 287
- Propane**  
 Detection Systems ..... 124  
 Grill Accessories ..... 125  
 Grill Fittings ..... 124  
 Grill Hose & Connectors ..... 125  
 Lockers & Tanks ..... 124  
 Regulators ..... 125  
 Tank Adapters ..... 125
- Propellers**  
 Bombardier ..... 21  
 Evinrude ..... 21  
 Folding ..... 34  
 Honda ..... 19  
 Line Cutter ..... 34  
 Mercury ..... 20  
 Outboard ..... 19-21, 34  
 Prop Nuts ..... 36-37  
 Shaft Shark ..... 34  
 Tohatsu ..... 20  
 Torqeedo ..... 21  
 Yamaha ..... 20
- Pumps**  
 A/C ..... 141  
 Accessories ..... 98, 102, 105  
 Automatic ..... 97  
 Baitwell ..... 101  
 Battery Operated ..... 10  
 Bilge, Automatic ..... 97  
 Bilge, Electric ..... 98-99  
 Bilge, Manual ..... 96
- Booster ..... 102  
 Drain ..... 118  
 Electric ..... 10, 98-102, 108, 118, 141  
 Emergency ..... 167  
 Engine Cooling ..... 31  
 Fender ..... 58  
 Float Switches ..... 98-99, 102  
 Foot ..... 10, 121  
 Fuel ..... 24  
 Galley ..... 121  
 General Purpose ..... 118  
 Hand ..... 121  
 Handheld ..... 96  
 Hydraulic Steering ..... 251-255  
 Inflatable Boat ..... 7, 10  
 Inflator/Deflator ..... 10  
 Macerator ..... 108  
 Manual ..... 10  
 Oil Changers ..... 27  
 Refrigeration ..... 141  
 Resin/Hardener ..... 193  
 Sea Water ..... 141  
 Shower Drain ..... 118  
 Strainers, Inline ..... 102  
 Submersible ..... 97-99  
 Submersible, A/C ..... 141  
 Sump ..... 118  
 Utility ..... 118  
 Washdown ..... 102  
 Waste ..... 118  
 Water ..... 100-101
- Q**  
**Quick Connects** ..... 113  
**Quick Release Pins** ..... 70
- R**  
**Racor**  
 Filters ..... 26  
 Fuel/Air/Water Separators ..... 26
- Radar**  
 Mounts ..... 273, 276  
 Reflectors ..... 172  
 Towers ..... 273, 275-276
- Radars**  
 B&G ..... 262, 265  
 Furuno ..... 270-271  
 Lowrance ..... 265  
 Raymarine ..... 259  
 Simrad ..... 263, 265  
 Si-Tex ..... 267
- Radios**  
 Copper Foil ..... 235  
 Grounding Plates ..... 235  
 Remote Mics ..... 243-244  
 SSB ..... 235  
 VHF's, Fixed Mount ..... 243-245, 270  
 VHF's, Handheld ..... 240-241, 245
- Rags & Towels** ..... 207
- Rail**  
 Antenna Mounts ..... 231, 236  
 Hardware ..... 187
- Rain Shield, Porthole** ..... 145
- Ranges** ..... 126-127
- Raritan**  
 Heads & Head Accessories ..... 103, 105-106  
 Ice Makers ..... 129  
 Macerator Pumps ..... 108  
 Maintenance & Cleaning Products ..... 105, 109  
 Plumbing Fittings ..... 105, 112  
 Sanitation Hose ..... 105  
 Service Kits ..... 105  
 Strainers ..... 32  
 Valves ..... 105  
 Vented Loops ..... 110  
 Waste Treatment Systems ..... 108  
 Water Heaters ..... 117  
 Y-Valves ..... 110
- Raymarine**  
 AIS Systems ..... 238  
 Autopilots ..... 252-253  
 Axiom ..... 258  
 Cables, Instrument ..... 246
- Cables, Radar ..... 259  
 Cables, Raynet ..... 246  
 Element ..... 261  
 Evo Autopilots ..... 252-253  
 Fishfinders ..... 260  
 GPS Sensors ..... 259  
 Hailers ..... 235, 243  
 Heading Sensors ..... 253  
 i40 i50 & i60 ..... 250  
 i70 ..... 246  
 Instrument Displays ..... 246, 250  
 Multifunction Displays ..... 246, 258  
 Navigation Software ..... 260  
 Night Vision Cameras ..... 261  
 Radars ..... 259  
 Remote Mics ..... 243  
 Smartpilots ..... 252  
 Sonar/GPS ..... 258, 261  
 Sounders ..... 260  
 Tillerpilots ..... 252-253  
 Transducers ..... 246, 250, 260  
 VHF's, Fixed Mount ..... 243  
 Wheelpilots ..... 252-253  
 Wireless Gateway ..... 250
- Re-Arm Kits**  
 Mustang ..... 160  
 Reverse ..... 163
- Receptacles, Electrical** ..... 281-283
- Reefing Kits** ..... 93
- Reference Charts**  
 Chain Selection ..... 45  
 Flooring & Custom Cloth Color ..... 158  
 Lifeline Measurement ..... 68  
 Navico Autopilot Selection ..... 255  
 Splicing Fees ..... 66
- Refrigeration** ..... 130-133  
 Pumps ..... 141
- Refrigerators** ..... 130-133
- Registration Products**  
 Inflatable Boats ..... 8, 15  
 Letters & Numbers ..... 8, 15, 190  
 Plates, Stencils ..... 8, 15
- Regulators** ..... 125, 277
- Remote Mics** ..... 243-244
- Repair Kits, Gel Coat** ..... 195
- Replacement Bulbs** ..... 298-299, 309
- Rescue & Emergency Boats** ..... 8
- Rescue Lights** ..... 165
- Rescue Slings** ..... 168
- Resin** ..... 192-195  
 Additives ..... 192-193, 195  
 Epoxy ..... 192, 195  
 Fillers ..... 193, 195  
 Pigments ..... 194
- Respirators** ..... 207
- Reverse**  
 Liferrafts ..... 169  
 Lifevests ..... 163  
 PFD's ..... 163  
 Re-Arm Kits ..... 163  
 Rescue Lights ..... 165
- Reverso**  
 Flushing Systems ..... 27  
 Oil Changers ..... 27
- Richardson's Chartbooks** ..... 222
- Rigging**  
 Bags ..... 137  
 Books ..... 228  
 Custom ..... 67  
 Fittings ..... 67  
 Hardware ..... 67-68, 70  
 Hayn Fittings ..... 67  
 Insulators ..... 67  
 Knives ..... 199  
 Quick Release Pins ..... 70  
 Rigging/Splicing Fees ..... 66  
 Sleeves ..... 68  
 Stay Extenders ..... 70  
 Swage Terminals ..... 68  
 Swage Tools ..... 67  
 Tape ..... 90  
 Terminals ..... 67  
 Toggles ..... 68, 70  
 Turnbuckles ..... 70  
 Wire ..... 67-68
- Wire Cutters ..... 67
- Ring Buoys** ..... 167-168
- Rings** ..... 90-91, 190
- Ritchie Compasses** ..... 226-227
- Rivets** ..... 178
- Rocna Anchors** ..... 48
- Rod Holders & Mounts** ..... 186
- Rodes** ..... 44
- Rollers**  
 Anchor ..... 50  
 Bow ..... 50  
 Paint ..... 193, 197, 218  
 Shroud ..... 91
- Ronstan**  
 Blocks ..... 76, 84, 93  
 Boom Bails ..... 93  
 Cleats & C-Cleats & Bases ..... 78  
 Constrictor Clutch ..... 76  
 Rope Clutches ..... 76  
 Sail Shackles ..... 91  
 Shackles ..... 81  
 Tiller Extensions ..... 39  
 T-Track ..... 88  
 Vangs ..... 85  
 Watches ..... 158
- Rope** ..... See Line
- Rope Clutches** ..... 76, 79
- Rope Cutting Gun** ..... 51
- Rope/Chain Rodes** ..... 44
- Rope/Cord** ..... See Line
- Rosepoint Navigation Software** 230
- Rub Rails** ..... 62, 181
- Rugged Shark Boots & Shoes** ..... 156
- Rule**  
 Baitwell Pumps ..... 101  
 Bilge Alarms ..... 98  
 Bilge Pumps ..... 97-98  
 Blowers ..... 150  
 Pumps ..... 118  
 Switches ..... 98
- S**  
**Safety** ..... 159-174
- Safety Guards & Netting** ..... 172
- Sail**  
 Accessories ..... 91, 93  
 Bags ..... 94  
 Battens ..... 90  
 Clevis Pins ..... 90  
 Clips ..... 91  
 Cloth ..... 90  
 Genoa Sleeves ..... 90  
 Hooks ..... 91  
 Instruments ..... 246, 249-250, 254, 256  
 Letters & Numbers ..... 190  
 Needles ..... 177  
 Registration Plates ..... 8, 15  
 Repair Kits ..... 177  
 Rollers ..... 91  
 Sewing Kits ..... 177  
 Slides ..... 88, 91  
 Slugs & Snaps ..... 91  
 Spinnaker Sleeves ..... 90  
 Tape ..... 90  
 Ties ..... 91, 179  
 Track ..... 88-89, 91  
 Travelers ..... 89  
 Twine ..... 177
- Sailboat Hardware/Equipment**  
 Accessories ..... 93  
 Backstay Adjusters ..... 70  
 Bailers ..... 91  
 Battens ..... 90  
 Blocks ..... 71-76, 78, 84, 86, 88-89  
 Boom Bails ..... 93  
 Boom Supports ..... 85  
 Bosun's Chairs ..... 94  
 Cam Cleats ..... 74, 78  
 Cars & Stops ..... 88-89  
 Clamcleats ..... 78  
 Clevis Pins ..... 90  
 Clinometers ..... 93  
 Control Blocks ..... 89  
 Deck Organizers ..... 79
- Furling Accessories ..... 86  
 Furling Systems ..... 86-87  
 Genoa Sleeves ..... 90  
 Halyard Leads ..... 75  
 Insulators ..... 67  
 Lazy Jacks ..... 93  
 Lead Blocks ..... 78, 88  
 Lifeline Hardware ..... 68-70  
 Lifelines & Wire ..... 68-69  
 Line Cleats ..... 78  
 Low Friction Rings ..... 72  
 Mast Steps ..... 94  
 Padeyes ..... 77  
 Pole Fittings ..... 92  
 Pole Storage ..... 92  
 Quick Release Pins ..... 70  
 Reefing Kits ..... 93  
 Rigging Hardware ..... 67-68, 70  
 Rigging Tools ..... 67, 70  
 Rigging Wire ..... 67-68  
 Rope Clutches ..... 76, 79  
 Sail Accessories ..... 91  
 Sail Cloth ..... 90  
 Sail Slides ..... 88  
 Sail Tape ..... 90  
 Sailkote ..... 91  
 Shackles ..... 46, 80-81  
 Sheaves ..... 74  
 Snatch Blocks ..... 84  
 Spinnaker Poles ..... 92  
 Spinnaker Sleeves ..... 90  
 Spreader Boots ..... 94  
 Stanchions ..... 69  
 Stay Extenders ..... 70  
 Swageless Fittings ..... 67  
 Tell Tales ..... 95  
 Terminals ..... 67-68  
 Tillers & Extensions ..... 39  
 Toggles ..... 68-70  
 Torlon Ball Bearings ..... 89  
 Track ..... 88-89, 91  
 Travelers ..... 89  
 Turnbuckle Covers ..... 93  
 Turnbuckles ..... 68-70  
 Universal Adapters ..... 74  
 Vangs ..... 85  
 Whisker Poles ..... 92  
 Winch Accessories ..... 83-84  
 Winch Handles ..... 84  
 Winches ..... 82-83  
 Wind Indicators ..... 95  
 Wind Vanes ..... 95  
 Yacht Rods ..... 85
- Sailboat Steering Wheels** ..... 38
- Sailcloth** ..... 90
- Sailkote Lubricant** ..... 91
- Samson**  
 3-Strand Nylon ..... 43  
 Anchor & Dock Lines ..... 43  
 AS-78 ..... 65  
 Cordage ..... 65  
 Double Braid ..... 43, 65  
 Floatline ..... 65  
 Lash-It ..... 65  
 Mini Braid ..... 65  
 MLX3 ..... 65  
 Splicing Kits & Tools ..... 43  
 XLS ..... 65
- Sandpaper** ..... 207
- Satellite**  
 Communications ..... 243  
 Stereos ..... 234  
 TV Systems ..... 237
- Scandvik**  
 Drains ..... 121  
 Faucets ..... 118, 120  
 Hose Clamps ..... 114  
 Lighting ..... 301-303, 306-307  
 Lighting ..... 308  
 Replacement Bulbs ..... 309  
 Showers ..... 118-120  
 Sinks ..... 121  
 Spigots ..... 120
- Scanstrut**  
 Deck Seals ..... 295

- Instrument Housings & Mounts... 256, 276  
Junction Boxes... 295  
ROKK... 256
- Schaefer**  
Anchor Hangers... 51  
Blocks... 74-75, 84, 88  
Boom Bails... 93  
Boom Vangs... 85  
Cam Cleats... 74  
Cars & Stops... 88  
Chocks & Cleats... 57  
Deck Organizers... 79  
Exit Plates... 93  
Furling Blocks... 86  
Furling Systems... 87  
Halyard Leads... 75  
Lazy Jacks... 93  
Lead Blocks... 88  
Line Organizers... 137  
Padeyes... 77  
Sail Slides... 88  
Shackles... 81  
Sheaves... 74  
Stanchions... 69  
Travelers... 89  
T-Track... 88  
Universal Adapters... 74  
Vangs... 85  
Winch Handles... 84  
Wind Indicators... 95
- Scoprega/Bravo Pumps & Accessories**... 10
- Screens**  
Hatch... 146-147  
Insect... 149  
Port... 144-145  
Shade... 147
- Sea Anchors**... 172
- Sea Hawk**  
Epoxies & Catalysts... 193  
Fillers... 193  
Paints... 212
- Sea Tech Fittings, Quick Connect**... 113
- Seacocks**... 111-112
- Sea-Dog**  
Anchors... 49  
Chafe Kits... 51  
Clamshell Vents... 150  
Cleats & Clamcleats... 78  
Courtesy Lights... 304-306  
Cowl Vents... 150  
Crimp Tools... 293  
Dock Cleats... 57  
Dome Lights... 306  
Gas Tank Straps... 23  
Handles & Latches... 188  
Horns, Manual... 170  
LED Lights... 298, 301, 303-307  
Mast Steps... 94  
Navigation Lights... 298  
Oarlocks... 11  
Reading/Chart Lights... 307-308  
Rod Holders... 186  
Splicing Tools... 51  
Spotlight/Floodlights... 301
- Seagull Water Purifiers/Filters**... 115
- SeaLand**  
Deodorants... 109  
Head Accessories... 105  
Heads... 104, 107  
Holding Tanks... 108-109  
Pumps... 108  
Sanitation Hose... 114  
Valves... 105
- Sealant Remover**... 191
- Sealants**... 191, 216
- Sealing Strips & Tape**... 148, 151
- Seam Sander**... 197
- Seaquest/Naugahyde**... 176
- Searchlights**... 300
- SeaStar Solutions**  
Connection Adapters... 35  
Control Cables... 35  
Engine Control Arms, Knobs... 34
- Steering Systems... 40
- SeaTeak Teak & Teak Products**... 136, 182-183, 186, 198
- Seats**  
Covers... 180, 183  
Deck Chairs... 183  
Helm... 184-185  
Inflatable Boat... 12  
Lounge Chairs... 185
- Seaview**  
Instrument Housings & Mounts... 275
- Seaward Water Heaters**... 116
- Seizing Wire**... 46
- Selden Sailing Hardware**... 73-74, 83, 86
- Semco Sealer**... 215
- Sen-Dure Heat Exchangers**... 30
- Sensibulb**... 309
- Separators**... 26
- Sewing Kits & Accessories**... 177
- Sewing Machines**... 177
- Sextants**... 229
- Shackle Keys**... 199
- Shackles**  
Anchor... 46  
Carabiners... 190  
Clevis Pin... 81  
Deck Pipe... 46  
Halyard... 81  
Hooks... 190  
Rings... 190  
Sail... 91  
Snap... 81, 190  
Soft... 81  
Stainless Steel... 46, 80-81  
Swivels... 46  
Thimbles... 46
- Shades**  
Boat... 180  
Hatch... 147  
Port... 144-145  
Screen... 146-147
- Shaft**  
Line Cutter... 34  
Packing & Tools... 30  
Seals... 30  
Shark... 34
- Shaft Bearings, Brass**... 30
- Shakespeare Antennas & Mounts**... 231, 235-236
- Sheaves**... 74
- Sherwood Impellers & Pumps**... 31
- Shift Knobs**... 34
- Shock Cord & Accessories**... 179
- Shoes**  
Men's... 155-156  
Women's... 156
- Shore Power Cords/Adapters & Accessories**... 281-284
- Showers**... 118-120
- Shrink Wrap & Accessories**... 220
- Shroud**  
Rollers... 91  
Wire... 68
- SHURflo**  
Bilge Pump Switches... 99  
Bilge Pumps... 99  
Blowers... 150  
Faucets... 119-120  
Impellers... 105  
Pumps... 102, 108  
Showers... 118-119  
Spigots... 12  
Strainers... 32  
Water Filters... 115  
Water Pumps... 100
- Shurhold**  
GoPro Camera Mount Adapters... 206  
Maintenance Kits & Tools... 206  
Pad Cleaners... 202  
Polishers... 207
- Side Power Thrusters**... 42
- Sierra Marine Gauges**... 29
- Signal Mate Navigation Lights**... 298
- Signal Mirrors**... 165
- Signs**... 190
- Sikaflex Adhesive Sealants**... 191
- Sikkens Varnishes**... 214
- Silent Running**... 33
- Simrad**  
AIS Systems... 238, 245  
Autopilots... 254-255  
Heading Sensors... 255  
Instruments... 249  
Multifunction Displays... 263  
Radars... 263, 265  
Sounders... 263, 265  
Tillerpilots... 255  
WiFi Interface... 263
- Sinks**... 121
- Si-Tex Electronics**... 238, 251, 267
- Slings, Lifting**... 17
- Smart Tabs**... 41
- Smartpilots**... 251-252
- SmartPlug Inlets and Connectors**... 283
- Smoke & Heat Detectors**... 174
- Snap Hooks**... 72, 179, 190
- Snap Shackles**... 81
- Software**  
Navigation... 230, 257  
Weather... 247
- Solar**  
Dock Lights... 308  
LED Lights... 299  
Vents... 151
- Solar Panels & Accessories**... 21, 288-289
- Solenoids**... 124
- Solvents**... 195, 211, 217
- Sonar**... 247, 258-261, 263-265
- Sony Stereos & Stereo Accessories**... 233
- SOSpenders**... 164
- Sounders**... 247, 260, 263, 265, 270
- Soundproofing**... 33
- Southco Latches**... 188-189
- Spark Plugs**... 19-21, 24
- Speakers**  
Remote VHF... 235, 242, 244  
SSB... 235  
Stereo... 232-234
- Spectra Watermakers**... 115
- Sperry Shoes**... 156
- Spigots**... 120
- Spinlock**  
Cam Cleats... 78  
Deck Organizers... 79  
Furling Blocks... 86  
Lifevests... 163  
Mast Harnesses... 94  
Rope Clutches... 79  
Tiller Extensions... 39
- Spinnaker**  
Poles... 92  
Sleeves... 90  
Slides... 88
- Splicing**  
Books... 228  
Kits & Tools... 43, 51, 293  
Splicing Fees... 66
- Sponges**... 206
- Spotlights**  
Fixed Mount... 300  
Handheld... 300
- Spreader Boots**... 94
- Springfield Chairs**... 184-185
- SSB**  
Antennas... 235-236  
Back Stay Insulators... 67  
Copper Foil... 235  
Grounding Plates... 235  
Radios... 235  
Speakers... 235
- St. Croix**  
Davits... 16  
Ladders... 14
- Stabilized Binoculars**... 225
- Stabilizers**... 63
- Sta-Lok Terminals**... 67
- Stanchion Kits**... 274
- Standard Horizon**  
AIS Systems... 244  
Hailer Horns... 235  
Remote Mics... 244  
VHF's, Fixed Mount... 244  
VHF's, Handheld... 241
- Star Brite**  
All Purpose Cleaners... 201  
Bilge Cleaners... 204  
Cleaners & Waxes... 201-203, 216  
Cleaning Tools... 206  
Hull Cleaners... 200  
Mildew/Odor Control... 200  
Plastic Cleaner... 205  
Vinyl & Fabric Care... 205
- Starboard**... 198
- Steaming Cones**... 51
- Steamers**  
Lifevests... 162  
PFD's... 162  
Sun Showers... 119  
Tethers... 164
- Steering**  
Accessories... 38-40  
Autopilots... 251-255, 267  
Cables... 40  
Controls... 35  
Hose... 40  
Hydraulic... 40, 251-255  
Hydrofoils... 41  
Knobs... 40  
Motor Well Boots... 40  
Steering Systems... 40  
Thrusters... 42  
Tillers... 39  
Trim Tabs... 41
- Steering Wheels**... 38, 40  
Accessories... 38-39  
Folding... 38  
Knobs... 40  
Powerboat... 40  
Sailboat... 38  
Stainless Steel... 40
- Steiner Binoculars**... 224
- Steps**  
Boat... 61  
Inflatable Boat... 14  
Mast... 94
- Stereo Enclosures**... 235
- Stereos**... 232-234
- Sterling Power**... 285
- StingRay Hydrofoils**... 41
- Stoves**  
Accessories... 126  
Cooktops... 127-128  
Ranges... 126-127
- Strainers**... 111-112  
Fresh Water... 102  
Inline Bilge... 102  
Raw Water... 32
- Strippers**... 211
- Strobe Lights**... 165
- StructureScan Sonar**... 265
- Sun Showers**... 119
- Sunbrella**... 176
- Suncor**  
Anchor Swivels... 46  
Bow/Stern Eyes... 189  
Chocks & Cleats... 57  
Hinges... 188  
Jacklines... 164  
Lifeline Wire & Kits... 69  
Padeyes... 77  
Rail Hardware... 187  
Ratchet Tie Downs... 18  
Shackles... 80  
Toggles... 70
- Sunglasses**... 157
- Surface Prep**... 211, 213
- Survitec Survival Products**... 169
- Swage Tools**... 67
- Swageless Fittings**... 67
- Swim Platforms**... 61
- Switch Panels**... 290, 292
- Switches**  
Battery... 279-280  
Bilge... 98-99, 102  
Float... 98-99, 102  
Foot, Windlass... 53, 55-56  
Ignition... 291-292  
Panel... 291-292  
Toggle... 291-292  
Windshield Wipers... 221
- Swivels**... 46, 55
- System Three Epoxies**... 194, 215

## T

- Tables**  
Cleaning Stations... 122  
Cockpit... 182  
Deck... 183  
Fishing... 122
- Tack Rags**... 215, 217
- Taco**  
Bait/Filet Tables... 122  
Boarding Handles... 60  
Dock Bumpers... 62  
Glyde Slicks... 17  
Leaning Posts... 185  
Outrigger Kits... 186  
Rail Hardware... 187  
Rod Holders... 186  
Rub Rail Kits... 181  
Spreader Lights... 301
- Tangs**... 93
- Tank Monitors**... 110
- Tanks**  
Accumulator... 102  
Aluminum... 124  
Cleaners... 109  
Cleaning Systems... 30  
Diesel... 109  
Flexible... 109, 117  
Fuel... 23  
Fuel Connectors... 23  
Fuel Line Assemblies... 23  
Fuel Sender Kits... 23  
Fuel, Outboard... 19-21, 23  
Gas Tank Straps... 23  
Grey Water... 117  
Holding... 109  
Monitors... 110  
Potable Water... 117  
Propane... 124  
Steel... 124  
Vents... 24  
Waste Treatment Systems... 108-109  
Water... 117
- Tape**  
Electrical... 294  
Emergency Repair... 114  
Episize... 197  
Fiberglass Repair... 197  
Foil, Soundproofing... 33  
Glass Sealing... 151  
Hatch... 148, 151  
Masking... 218  
Mast Boot... 90, 94  
Mylar... 33  
Rigging... 90  
Sail Cloth... 90  
Sail Repair... 90  
Seaming, Canvas... 176  
Shrink Film... 220
- Tarps**... 219
- Taylor Made**  
Boat Covers... 9  
Boat Shades... 180  
Boat Steps... 61  
Console Covers... 180  
D-Icer... 219  
Dock Boxes... 63  
Dock Bumpers... 62  
Dock Carts... 63  
Dock Lights... 308  
Dock Steps... 61  
Dock Wheels... 62  
Fender Covers... 59  
Fenders & Accessories... 59



- Flag Poles & Sockets ..... 138  
 Mooring Balls ..... 47  
 Seat Covers ..... 180, 183  
 Spreader Boots ..... 94
- Teak**  
 Binocular Racks ..... 136, 225  
 Cockpit Tables ..... 182  
 Dorade Boxes ..... 150  
 Flag Poles ..... 138  
 Galley & Head Accessories ..... 136  
 Hand Rails ..... 136  
 Louvers & Doors ..... 136, 142  
 Lumber ..... 198  
 Molding ..... 136  
 Organizers ..... 136  
 Pedestal Tables ..... 183  
 Plugs ..... 136  
 Rod Holders ..... 186  
 String Mat ..... 136  
 Tables ..... 182-183  
 Winch Pads ..... 83
- Teak & Holly Flooring** ..... 175  
**Teak Care Products** ..... 215-216  
**Tecma Heads** ..... 107  
**Teleflex** ..... 29, 34-35, 40  
**Tell Tales** ..... 95  
**Tempress Chairs** ..... 184-185  
**Tenders** ..... 2-8  
**Tension Gauges** ..... 70  
**Terminal Blocks** ..... 292, 295  
**Terminals, Sailing Hardware** ..... 67  
**Test Meters** ..... 284  
**Tethers** ..... 164  
**Thermometers** ..... 139  
**Thetford**  
 Deodorants ..... 109  
 Heads ..... 104  
 Maintenance Kits ..... 105  
**Thimbles** ..... 46  
**Thinners** ..... 209, 211, 214  
**Thread** ..... 177  
**Throttle Knobs** ..... 34  
**Thru-Hulls & Fittings** ..... 111-112  
**Thrusters & Thruster Accessories** ..... 42  
**Tie Down Cordage** ..... 180  
**Tillerpilots** ..... 253, 255  
**Tillers & Tiller Extensions** ..... 22, 39  
**Todd**  
 Boat Steps ..... 61  
 Chairs ..... 184-185  
 Holding Tanks ..... 109  
 Leaning Posts ..... 185  
 Tables ..... 183  
 Water Tanks ..... 117  
**Toggles** ..... 68-70  
**Tohatsu**  
 Fuel Tanks ..... 20  
 Maintenance Parts ..... 20  
 Outboard Engines ..... 20  
 Outboard Parts & Accessories ..... 20, 24-25  
 Replacement Parts ..... 20  
**Toilet Paper** ..... 109  
**Toilets** ..... 103-104, 106-107  
 Chemicals ..... 109  
 Conversion Kits ..... 103, 105  
 Electric ..... 106-107  
 Hose ..... 105, 114  
 Macerator Pumps ..... 108  
 Manual ..... 103-104  
 Portable ..... 104  
 Self-Contained ..... 104  
 Toilet Paper & Holders ..... 109
- Tools**  
 Bags ..... 137  
 Canvas ..... 178  
 Caulking ..... 197  
 C-Clamp Pliers ..... 179  
 Cleaning Tools ..... 206  
 Crimp ..... 67, 294  
 Deck Plate Keys ..... 24  
 Dot Fasteners ..... 178  
 Filter Vacuum Gauges ..... 26  
 Grommet Kits ..... 178  
 Heat Guns ..... 220
- Kits ..... 178  
 Knives ..... 164, 186, 199  
 Lifeline ..... 67  
 LPG Leak Testers ..... 125  
 Measuring Cups ..... 193  
 Navigation ..... 229  
 Packing ..... 30  
 Paint & Epoxy ..... 193  
 Paint Mixer ..... 218  
 Plotting ..... 223  
 Polishers ..... 207  
 Resin Filler Spreaders ..... 195  
 Rigging ..... 67, 70, 199  
 Rivets ..... 178  
 Rope Cutters ..... 51  
 Shackles Keys ..... 199  
 Snap Tools ..... 178  
 Splicing Tools ..... 43, 51, 293  
 Swage ..... 67  
 Tension Gauges ..... 70  
 Tool Sets ..... 178, 199  
 Wire Cutters ..... 67, 294
- Torqueedo** ..... 21  
**Tow**  
 Bridles ..... 17  
 Harnesses ..... 152  
 Rope ..... 17, 152  
**Towables** ..... 152  
**Trac Ecological** ..... 109, 200  
**Track** ..... 88-89  
**Track Slides** ..... 88, 92  
**Trailer Accessories** ..... 17-18  
**Transducers**  
 B&G ..... 262  
 Furuno ..... 271  
 Lowrance ..... 263-265  
 Raymarine ..... 246, 250, 260  
 Simrad ..... 265  
 Traveler ..... 89  
**Treadmaster** ..... 175  
**Trident**  
 A/C Hose ..... 142  
 Blower Hose ..... 150  
 Gas Lockers & Tanks ..... 124  
 Hose & Fittings ..... 32, 114, 125  
 Propane Tanks & Propane Products ..... 124  
**Trim Tabs** ..... 41  
**T-Top Shades** ..... 180  
**T-Track** ..... 88  
 **Tubes, Towable** ..... 152  
**Tubing**  
 Fiberglass, Wet Exhaust ..... 32  
 Plumbing ..... 113-114  
 Stainless Steel ..... 187  
**Turnbuckles**  
 Boots & Covers ..... 93  
 Lifelines ..... 68-69  
 Rigging ..... 70
- TV**  
 Cordsets ..... 283  
 Satellite Systems ..... 237  
**TV's** ..... 236  
 Antennas ..... 236, 248  
**Twine** ..... 177  
**Tylaska Snap Shackles** ..... 81
- U**  
**U-Bolts** ..... 189  
**Undercoaters** ..... 208-209, 211-213  
**Underwater Lighting** ..... 302  
**Underwater Metal Prep** ..... 208-209, 211-213  
**Uniden VHF Radios** ..... 240, 242  
**US Rigging Halyards** ..... 66  
**UST**  
 First Aid Kits ..... 171  
 Rescue / Emergency Lights ..... 165  
 Strobe Lights ..... 165
- V**  
**Vacuum Cleaners** ..... 129  
**Vacuum Gauges** ..... 26  
**Valves**  
 Check ..... 102
- Diverter ..... 110-111  
 Gas Control ..... 124  
 Non-Return ..... 112  
 Plumbing ..... 105, 111-113  
 Quick Connects ..... 113  
 Seacocks ..... 111-112  
 Shut-Off ..... 23, 111  
 Y-Valves ..... 110
- Valves, Air** ..... 14  
**Vangs** ..... 85  
**Varnishes** ..... 214-215, 217  
**VDO Marine Gauges** ..... 28  
**Velcro** ..... 177  
**Vented Loops** ..... 110  
**Ventilation** ..... 140-151, 220  
**Ventilators** ..... 150-151  
**Vents**  
 Boat Cover ..... 9  
 Clamshell ..... 150  
 Cowl ..... 150  
 Hose ..... 142, 150  
 Louvered ..... 142, 151  
 Shrink Film ..... 220  
 Solar ..... 151  
 Stainless Steel ..... 150-151  
 Tank ..... 24  
**Vesper Marine AIS Systems** ..... 239  
**Vetus**  
 Cowl Vents ..... 150  
 Flexible Tanks, Waste ..... 109  
 Flexible Tanks, Water ..... 117  
 Hatches ..... 146  
 Muffler Exhaust Systems ..... 33  
 Portholes ..... 144  
 Thrusters ..... 42  
 Water Strainers ..... 32
- VHF**  
 Antennas ..... 231, 236, 241  
 Radio Accessories ..... 231, 236  
 Radios ..... 240-245, 270  
 Remote Speakers ..... 235, 244  
**VHF Radios**  
 Fixed Mount ..... 242-245, 270  
 Handheld ..... 240-242, 245
- Vinyl**  
 Cleaners ..... 200, 205  
 Clear ..... 180  
 Flooring ..... 175  
**Vinyl Fabrics** ..... 180  
**Vitrifigo**  
 Ice Makers ..... 129  
 Refrigerators & Freezers ..... 133
- Voltmeters** ..... 290-291
- W**  
**Washer/Dryers** ..... 129  
**Waste Treatment Systems** ..... 108  
**Watches** ..... 158  
**Water**  
 Filters & Filter Systems ..... 115  
 Heaters ..... 116-117  
 Hose ..... 205  
 Inlets ..... 117  
 Makers ..... 115  
 Pressure Regulators ..... 117  
 Pumps ..... 100-101  
 Purifiers ..... 115  
 Strainers ..... 32  
 Tanks & Fittings ..... 117  
 Treatments ..... 117  
**Water Sensors** ..... 29  
**Watermakers** ..... 115  
**Watersports** ..... 152  
**Waterway Guides** ..... 229  
**Wave WiFi** ..... 248  
**Waxes & Polishes** ..... 202-203  
**Weather**  
 Electronic Barometers ..... 247  
 Enclosures, Stereo ..... 235  
 Instruments ..... 139, 247  
 Receivers ..... 247  
 Software ..... 247  
 Stations ..... 247  
**Weaver Davits & Accessories** ..... 15
- Webasto**  
 A/C & Heating Kits ..... 140, 143  
 A/C Accessories ..... 142  
 Heater Accessories ..... 142  
**Webbing & Accessories** ..... 179  
**Weems & Plath**  
 Barometers ..... 139  
 Bells ..... 170  
 Clocks ..... 139  
 Compasses ..... 227  
 Lamps & Oils ..... 307  
 Log Books ..... 223  
 Plotting Tools ..... 223  
 Rescue/Distress Lights ..... 165  
 Thermometers ..... 139  
 Tide & Time ..... 139  
 Yacht Lamps ..... 307
- Welcome Mats** ..... 60  
**Westbar Trailer Light Kits** ..... 18  
**West System**  
 Additives ..... 192-193  
 Epoxy Adhesive ..... 192  
 Epoxy Resin ..... 192, 195  
 Fillers ..... 193  
 Rollers ..... 193  
 Tape ..... 197  
 Tools ..... 192-193
- Wet Exhaust**  
 Elbows ..... 32-33  
 Fittings ..... 33  
 Hose ..... 32  
 Muffler Systems ..... 33  
 Tubing ..... 32
- Whale**  
 Baitwell Pumps ..... 101  
 Bilge Pumps ..... 96-97, 99  
 Booster Pump ..... 102  
 Faucets ..... 120  
 Float Switches ..... 99  
 Foot & Hand Pumps ..... 121  
 Macerator Pumps ..... 108  
 Plumbing, Quick Connect ..... 113  
 Pumps ..... 108, 118  
 Service Kits ..... 105  
 Showers ..... 118-119  
 Valves ..... 112  
 Water Pumps ..... 101
- Wheelpilots** ..... 251-253  
**Whipping Products** ..... 51  
**Whisker Poles** ..... 92  
**Whistles** ..... 165
- Wichard**  
 Blocks ..... 84  
 Dinghy Slings ..... 17  
 Fairleads ..... 86  
 Hooks ..... 190  
 Jacklines ..... 164  
 Padeyes ..... 77  
 Rigging Knives ..... 199  
 Safety Tethers ..... 164  
 Shackles ..... 80-81  
 U-Bolts ..... 189
- WiFi Interface** ..... 248, 259, 262-264  
**Winchers** ..... 83  
**Winches** ..... 18, 82-83  
 Conversion Kits ..... 82  
 Grease ..... 83  
 Handles ..... 84  
 Maintenance Kits ..... 83  
 Pads ..... 83  
 Trailer ..... 18  
 Winch Accessories ..... 82-84
- WinchRite Electric Winch Handles** ..... 84  
**Wind**  
 Indicators ..... 95  
 Instruments ..... 247, 249-250, 256  
 Vanes ..... 95  
**Windlasses & Accessories** ..... 52-56  
**Windline**  
 Anchor Locks ..... 50  
 Boarding Handles ..... 60  
 Chain Stoppers ..... 50  
 Ladders ..... 60  
**Window Channels** ..... 151
- Windsoops** ..... 149  
**Windshield Wipers** ..... 221  
**Winter Sticks** ..... 47  
**Winterizing**  
 Anti-Freeze ..... 220  
 Blue Poly Tarps ..... 219  
 Boat Cover Support Poles ..... 9, 219  
 Boat Stands ..... 220  
 Console Covers ..... 180  
 De-Icers ..... 219  
 Engine/Bilge Heaters ..... 143  
 Fogging Oil ..... 24  
 Heat Guns ..... 220  
 Ice Eaters ..... 219  
 Kover Klamps ..... 219  
 Motor Flushers ..... 27  
 Oil Changers ..... 27  
 Polypropylene Rope ..... 180  
 Poppits ..... 220  
 Seat Covers ..... 180  
 Shrink Wrap & Accessories ..... 220  
 Tarps ..... 219
- Wipers, Arms & Motors** ..... 221  
**Wire**  
 Battery ..... 294  
 Control Cables ..... 35  
 Cutters ..... 67, 294  
 Electrical ..... 294  
 Holders ..... 283  
 Lifeline ..... 68  
 Locking ..... 46  
 Rigging ..... 67-68  
 Seizing ..... 46  
 Shroud Covers ..... 91  
 Steering Cable ..... 40
- Wire Connector Terminals** ..... 293  
**Wire Management** ..... 295  
**Wireless**  
 Autopilots ..... 252-253  
 Intercom ..... 242-243  
 Weather Stations ..... 247
- Wood Care** ..... 194, 214-217  
**Woody Wax** ..... 202-203
- X**  
**Xantrex**  
 Battery Chargers ..... 285  
 Battery Monitors ..... 280  
 Inverters ..... 286-287  
 Inverters/Chargers ..... 286  
 Solar Panels ..... 288
- Y**  
**Yacht Rods** ..... 85  
**Yamaha Outboard Parts & Accessories** ..... 20  
**Yandina** ..... 280, 284  
**Yarn** ..... 177  
**YKK** ..... 177-178
- Z**  
**Zincs** ..... 36-37  
 Outboard Engine ..... 19  
 Thrusters ..... 42  
**Zippers** ..... 177  
**Zodiac**  
 Inflatable Boats ..... 2-3, 8  
 Parts & Accessories ..... 2, 11-12  
**Z-Tuff Cleaners** ..... 201-203

# The BRANDS you WANT and TRUST in STOCK for LESS!

Shop 24 hours,  
7 days a week,  
365 days a year

You can trust us to sell competitively-priced brand name products which provide you with quality and dependability. No one wants to be on the water and suffer a product failure. It pays to buy the name with experience and reliability.

**SAME DAY SHIPPING!...**  
For most orders placed by  
4:30 pm Eastern time, Monday - Friday.

## Over 50,000 Brand Name Products Stocked and Ready to Ship!

[www.defender.com](http://www.defender.com)

### DON'T MISS THE BOAT ON OUR EMAIL SPECIALS!

Click on "Get Advance Sales Notices" on our home page. Unique deals, specials, limited-time offers... You never know what you might find!

### WHY BUY FROM DEFENDER?

• Most orders placed by 4:30 PM ET (Monday - Friday) ship the same day • HUGE inventory - over 50,000 items in stock for same-day shipment • We are not obligated to collect sales tax on any orders shipped directly from our Connecticut warehouse to locations outside the state of Connecticut • Largest single Inflatable Boats and Outboard Motors Dealer in North America • Exceptional Value and Low Prices • Unsurpassed Product Selection • Top-Notch Customer Service

### DEFENDER'S LOW PRICE PROMISE

Defender is an authorized U.S. dealer/distributor for everything we sell. We offer new products backed by manufacturers' warranties. If you find a lower delivered price on an identical in-stock product from another authorized USA dealer, please email us at [orders@defender.com](mailto:orders@defender.com) or call us at 800-628-8225. In most cases we will match or beat the price. We want to earn your business so we stock trusted, well-known brands, have a friendly knowledgeable staff and offer you the best value!

### ANNUAL WAREHOUSE SALE

• 4 Incredible Days • Once a Year Savings!  
23rd Annual Warehouse Sale • Thursday, March 28 - Sunday, March 31, 2019  
Save on web and phone orders, too! Vendor samples, liquidations, special buys, overstocks and more!



### GIFT CERTIFICATES

Birthdays, holidays, Father's Day, Mother's Day, weddings... Give the perfect gift...

#### A Defender gift certificate!

Call 800-628-8225, visit [www.defender.com](http://www.defender.com), or shop in our Warehouse Outlet Store in Waterford, CT to purchase.

### SPECIAL ORDERS ARE OUR SPECIALTY!

If it's not in our catalog, we can get it for you! Call or email our experts with your Mfg's model # for a quote.  
Call 800-628-8225 • email: [specialorders@defender.com](mailto:specialorders@defender.com)

### CLEARANCE OUTLET

Amazing BARGAINS you won't find anywhere else. Unmatched values on leftovers, overstocks, demos, discontinued and one-of-a-kind items, vintage boating accessories, out-of-production parts, etc.  
Click on **CLEARANCE** from our home page.

### WAREHOUSE OUTLET STORE - 42 Great Neck Road, Waterford, CT 06385

Visit our 120,000 sq. ft. facility on 18 acres in Waterford, CT, less than 2 hours from NY or Boston. Huge selection of clearance, numerous boats and engines on display, shoes and clothing and all the newest electronics.

#### Directions: [www.defender.com/directions](http://www.defender.com/directions)

- **From New York and points West:**  
Take I-95 North to exit 75 straight onto Post Road/Route 1 North. Follow Route 1 for 3.7 miles. Then, see below.
- **From Boston and points East:**  
Take I-95 South to exit 81. Turn left onto Parkway North. At 2nd traffic light turn left onto Cross Road. Follow Cross Road to 2nd traffic light, turn left on Post Road/Route 1. Follow Route 1 for 1.6 miles. Then, see below.
- **From Worcester and points North:**  
Take Route 395 South to I-95 South to exit 75 and follow the sign for Post Road/Route 1 North (a left U turn). Follow Route 1 for 3.7 miles. Then, see below.

**THEN:** Turn right onto Avery Lane, go straight across the next intersection — Avery Lane becomes Great Neck Road. Defender Industries is 1/2 mile on the left.

Outlet Store Position: N 41° 20.020' W 72° 08.141'



### ORDERS

(800) 628-8225 Fax (800) 654-1616  
email: [orders@defender.com](mailto:orders@defender.com)  
Outside North America  
Phone (860) 701-3400 • Fax (860) 701-3424

### CUSTOMER SERVICE

(800) 435-7180 Fax (800) 654-1616  
email: [customerservice@defender.com](mailto:customerservice@defender.com)

### CONTACT CENTER & CUSTOMER SERVICE HOURS

Mid-April thru Mid-July Mid-July thru Mid-April  
M-F, 8:00am - 7:00pm ET M-F, 8:00am - 6:00pm ET  
Sat., 9:00am - 5:00pm Sat., 9:00am - 3:00pm  
Note: You can always shop online at [www.defender.com](http://www.defender.com)  
24 hours a day / 7 days a week / 365 days a year.

### OUTFITTING DESK

(888) 490-6844  
email: [outfitting@defender.com](mailto:outfitting@defender.com)

Just bought a boat? Planning a major trip or upgrade? Defender's expert outfitters can help! If you have a large or technical order, call or email us to take advantage of our outstanding Outfitting Service.

### COMMERCIAL ACCOUNTS

(800) 262-8727  
email: [comaccounts@defender.com](mailto:comaccounts@defender.com)

Special discounts and exemplary customer service for marinas, municipalities, charter companies, small & large established marine businesses alike!  
(800) 654-1616 fax  
Outside North America Phone (860) 701-3400  
Fax (860) 701-3426

### WAREHOUSE OUTLET STORE

(860) 701-3420  
Apr.-Oct. : M-W, 9am-5pm ET  
Hours Th-F 9am-6pm  
Sat. 9am-5pm  
\*Sun. 9am-3pm

Nov.-Mar. : Mon.-Sat., 9am-3pm

\*Closed Sundays starting mid-Sept.-March 24th.



### INFLATABLE BOATS & OUTBOARD MOTORS

email: [inflatables@defender.com](mailto:inflatables@defender.com)

From Avon to Zodiac, Defender is an authorized dealer and repair center for inflatable boats. We have the largest inventory of boats and motors in the country including RIBs, fully rigged with Yamaha, Honda, Tohatsu, Mercury or Evinrude outboard motors. We also carry all the accessories and parts you need.

### RIGGING SHOP

email: [rigging@defender.com](mailto:rigging@defender.com)

Defender offers four different types of rigging service: standing rigging, rope/chain rodes, eye splices and lifelines. For more information please visit [www.defender.com/rigging\\_form.jsp](http://www.defender.com/rigging_form.jsp)

### MINIMUM ADVERTISED PRICING

**M.A.P.** Some manufacturers set M.A.P. (Minimum Advertised Pricing) for their products, so we cannot advertise a lower price. However, this does not always apply to selling price. The actual price you will be charged is probably lower. Please call us at 800-628-8225 or visit [www.defender.com](http://www.defender.com) for further details.

## Defender® EMAIL DIRECTORY:

Clearance Items: [clearance@defender.com](mailto:clearance@defender.com)  
Commercial Accounts: [comaccounts@defender.com](mailto:comaccounts@defender.com)  
Customer Service: [customerservice@defender.com](mailto:customerservice@defender.com)  
Employment: [HR@defender.com](mailto:HR@defender.com)  
Information: [Info@defender.com](mailto:Info@defender.com)  
Inflatable Boats Sales & Service: [inflatables@defender.com](mailto:inflatables@defender.com)

Orders: [orders@defender.com](mailto:orders@defender.com)  
Outboard Motors Sales & Service: [outboards@defender.com](mailto:outboards@defender.com)  
Outfitting Assistance/Quotes: [outfitting@defender.com](mailto:outfitting@defender.com)  
Rigging Services: [rigging@defender.com](mailto:rigging@defender.com)  
Special Orders: [specialorders@defender.com](mailto:specialorders@defender.com)