

OCEANIC SYSTEMS DUAL ENGINE DISPLAY  
Part Numbers: 4166  
USER MANUAL

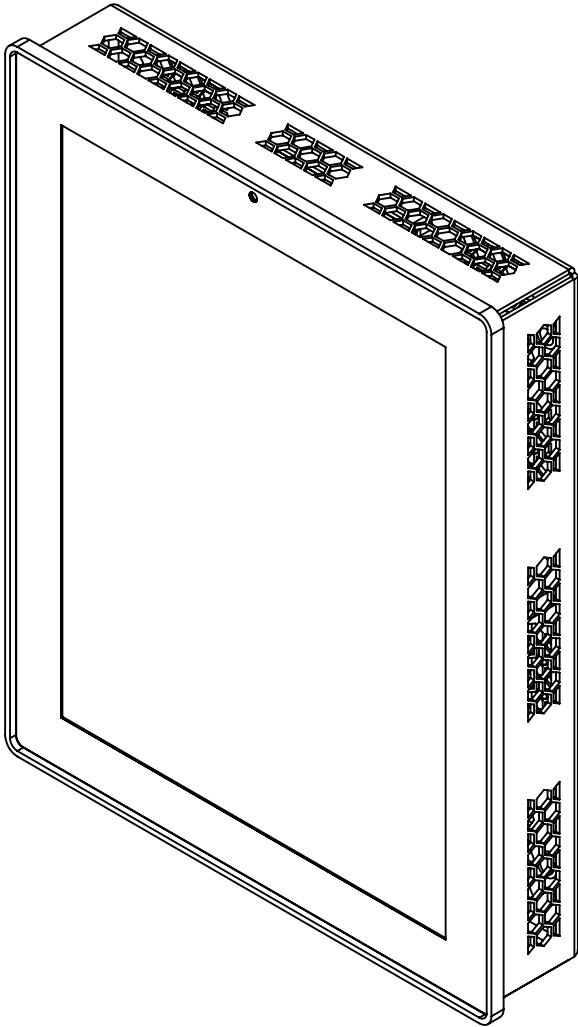

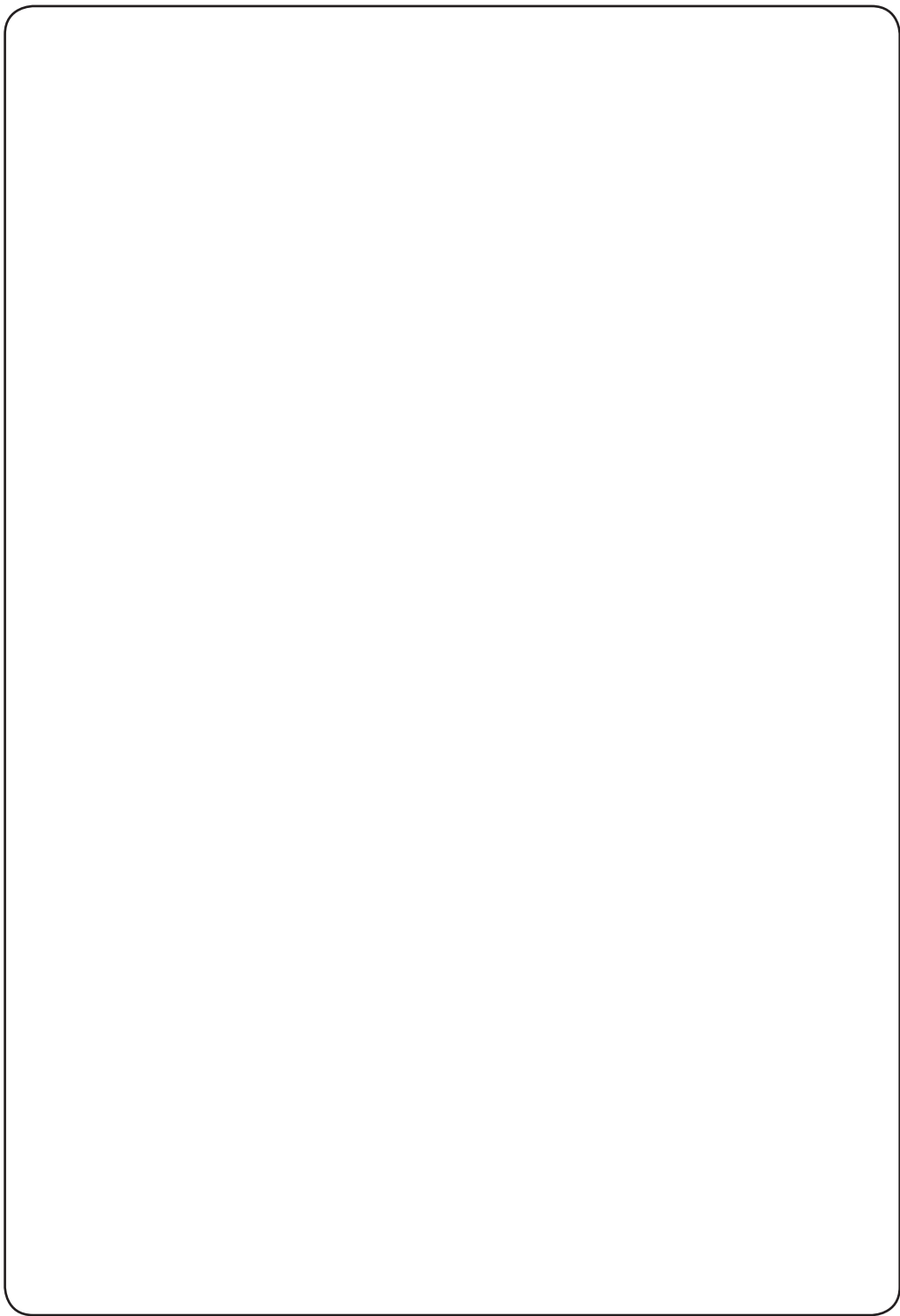

1	Introduction.....	2
1.1	Product Features.....	2
2	Unit Dimensions.....	3
3	Installation.....	4
3.1	Unpacking The Box.....	4
3.2	Mounting The Unit.....	4
3.3	Connecting The Marine Display.....	5
3.4	Selecting Engine Manufacturer & Device Set Up.....	7
3.5	Device Set Up.....	9
3.6	Fuel Bar Count.....	9
3.7	Engine Count.....	9
3.8	Mounting The Control Panel.....	10
4	User Controls.....	11
4.1	Button Functions.....	11
5	Technical Support.....	12
6	Warranty.....	13

The Oceanic Systems' NMEA2000® Dual Engine Display has a 10.4" diagonal display area and has a high bright sunlight readable 1000 cd/m2 display.

The Dual Engine Display can monitor two user selectable engines simultaneously, with alarm monitoring and logging.

It is supplied with a wired remote button panel, which can control the brightness of the display, acknowledge and clear alarm conditions

## 1.1 PRODUCT FEATURES

The Oceanic Systems' NMEA2000® Dual Engine Display has the following features:

- Sunlight readable dimmable display using our BlackGlass™ technology
- 768 x 1024 Resolution
- Remote button panel providing: Brightness up/down, Alarm Mute
- Monitoring of vessels engine status with alarms
- Internal 105dB Sounder
- Includes 1 x NMEA2000® and 2x J1939 interfaces
- Switchable internal line terminator resistors for J1939 interfaces
- User selectable Engine Manufacturer (MTU, MANN, Caterpillar & others) via rotary switch on rear of display
- User selectable metric or US imperial units
- Toughened glass screen
- IP rating for of IP65 for the front and IP20 for the rear of the display

2

UNIT DIMENSIONS

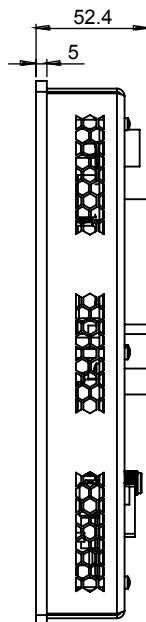
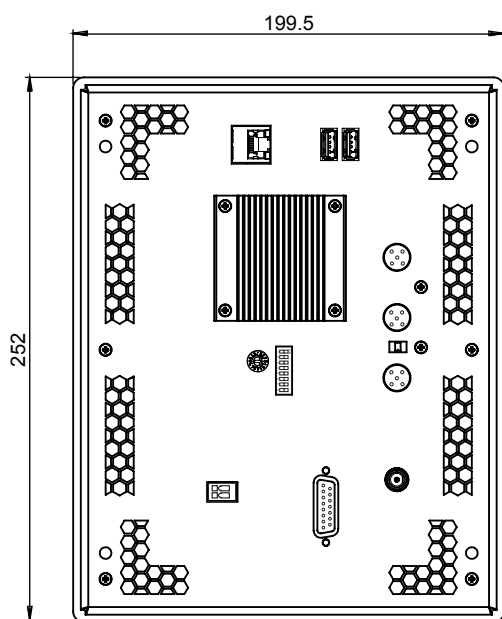
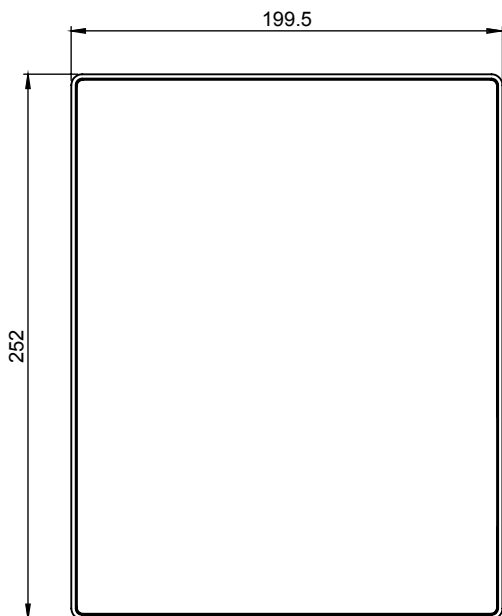

### 3

## INSTALLATION

### 3.1 UNPACKING THE BOX

You will find the following items in the shipping box:

- 1 x Dual Engine Display
- 1 x Remote button panel
- 1 x DC Power cable
- 1 x Bag containing 4 thumbwheel nuts & 4 sprung washers for button panel
- 1 x Bag containing 4 screws & 4 mounting clamps
- 1 x User Manual (This Document)

### 3.2 MOUNTING THE UNIT

1. The unit should be mounted through a panel to a flat surface min 8mm, max 25mm.
2. It can be mounted 45 degrees either way of vertical.
3. Ensure adequate ventilation around the product to prevent heat build up with a minimum of 50mm clearance.
4. Remember to allow enough clearance for access to cables and connectors. Cables should be retained to prevent damage to connectors.

Drawing showing panel cut out.

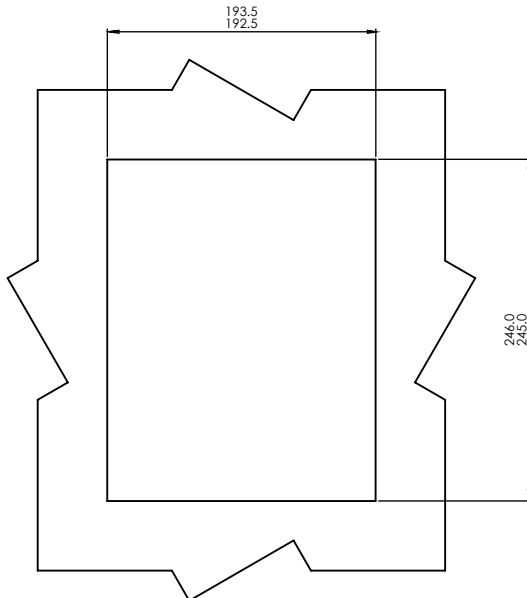

5. The unit should be sealed to the mounting surface using a suitable silicone sealant. This Silicone sealant will be part of the seal used to provide the IP rating for the product.
6. Using the 4 mounting clamps to the rear of display secure the unit to the mounting surface by tightening the screws.

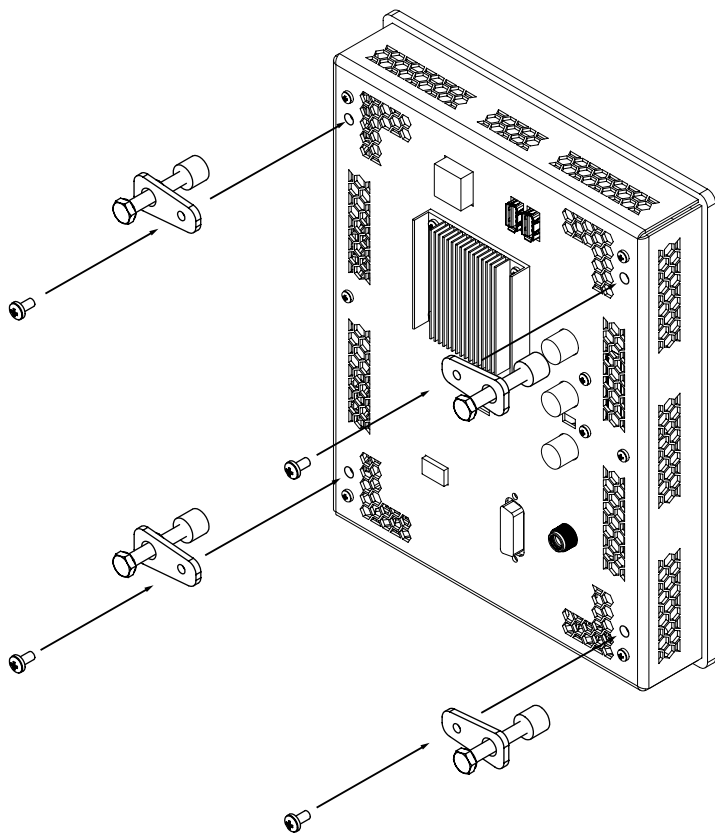

### 3.3 CONNECTING THE DUAL ENGINE DISPLAY

Before making any connections to the unit, ensure the NMEA2000® bus power and DC supply are turned off.

Requirements - 24VDC Supply 30W (1.25A).

Connect NMEA2000® cable to 'Socket' on the back of the unit, observing correct orientation to ensure the keyway aligns. The cable can be extended up to 6mtrs for connection into the T-adaptor on the network backbone. Ensure that the screw ring is securely tightened so that the connection remains sound.

Connect the two J1939 cables in the same manner.

Ethernet connector is for Oceanic Systems internal programming use ONLY.

The DC Power cable can be inserted into the port marked. Ensure correct orientation and make sure the screw ring is securely tightened. There are two USB A connectors, these are for program updates only.

Connect the Control Panel D Type Connector to the 15Way Remote Control Panel. Please see image below for reference.

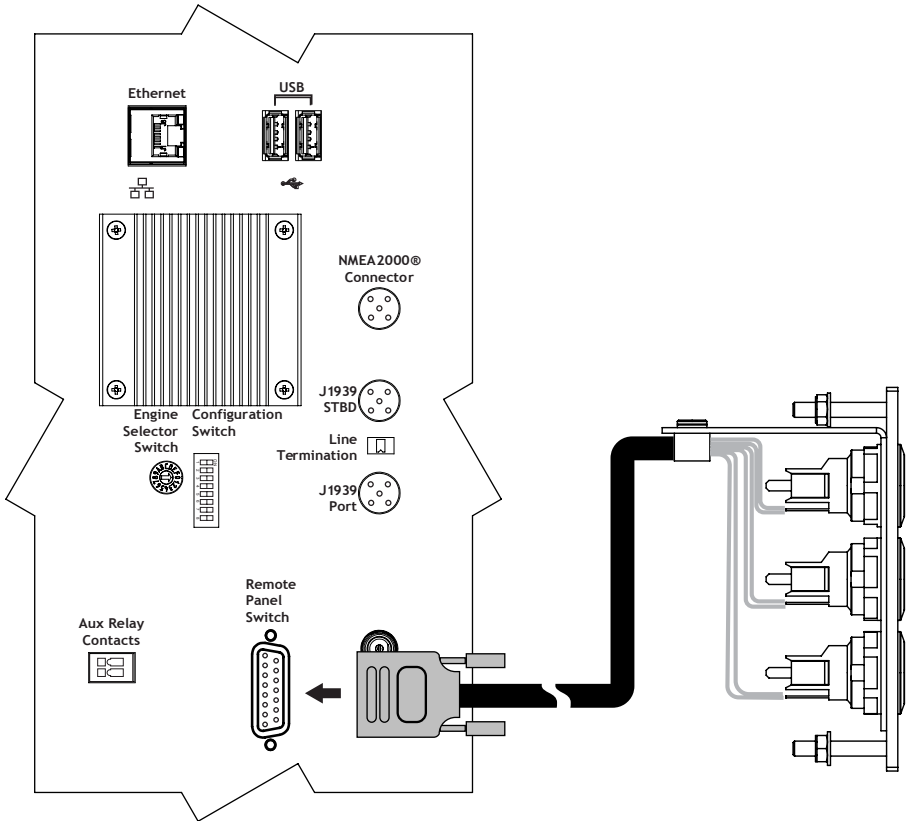

Male

Female

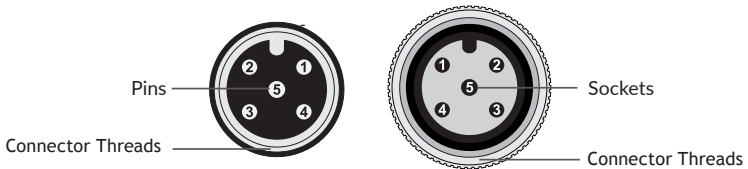

- Pin1: Shield
- Pin2: NET-S (power supply Positive, +V)
- Pin3: NET-C (power supply common, -V)
- Pin4: NET-H (CAN-H)
- Pin5: NET-L (CAN-L)



### 3.4 SELECTING ENGINE MANUFACTURER

Situated on the rear of the unit is an 8 Way Config switch & Rotary Switch.

To configure your engine display to inboard engine type make sure the DIP switch 7 is **OFF**

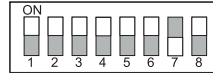

To set engine manufacturers follow the table to set rotary switch.



Switch No.	Engine manufacturer	Engine data source
0	Caterpillar	J1939
1	Cummins	NMEA2000®
2	MAN	J1939
3	MTU	J1939
4	Volvo	NMEA2000® from their gateway
5	Yanmar	NMEA2000®
6	John Deere	J1939
7	EDC7 Tier3	J1939
8	FPT	J1939
9	Generic	NMEA2000®
A	Generic	NMEA2000®
B	Generic	NMEA2000®
C	Generic	NMEA2000®
D	Generic	NMEA2000®
E	Generic	NMEA2000®
F	Generic	NMEA2000®

To configure your engine display to outboard engine type make sure the DIP switch 7 is **ON**

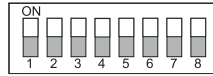

To set engine manufacturers follow the table to set rotary switch.



Switch No.	Engine manufacturer	Engine data source
0	Generic	NMEA2000®
1	Generic	NMEA2000®
2	Generic	NMEA2000®
3	Generic	NMEA2000®
4	Generic	NMEA2000®
5	Generic	NMEA2000®
6	Generic	NMEA2000®
7	Generic	NMEA2000®
8	Generic	NMEA2000®
9	Generic	NMEA2000®
A	Evinrude	NMEA2000®
B	Honda	NMEA2000®
C	Mercury	NMEA2000® from their Smartcraft adaptor
D	Yamaha	NMEA2000® from their own adaptor
E	Generic	NMEA2000®
F	Generic	NMEA2000®

### 3.5 DEVICE SET UP

To set engine type, number of engines, number of fuel gauges and units follow the table below to set the DIP switches on the Config Switch.

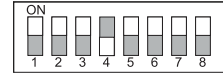

Switch No.	Switch OFF	Switch ON
1	Imperial units	SI Units
2	See fuel bar count selection below for details	
3		
4	See engine count selection below for details	
5		
6	Fuel value as %	Fuel value as unit
7	Inboard engines	Outboard engines
8	Not used	

### 3.6 FUEL BAR COUNT

Fuel bar count selection Switch 2 & 3					
Fuel bars	Switch 2	Switch 3	Reference	Fuel bars tank instances	Screen reference
1	OFF	OFF		0 - - -	
2	ON	OFF		0 - - 1	
3	OFF	ON		0 1 - 2	
4	ON	ON		0 1 2 3	

### 3.7 ENGINE COUNT

Engine count selection Switch 4 & 5					
Engines	Switch 4	Switch 5	Reference	Engine dial instances	Screen reference
2	OFF	OFF		0 1 - -	

### 3.8 MOUNTING THE CONTROL PANEL

Please see line drawing showing outline, mounting studs and mounting area for the Control Panel.

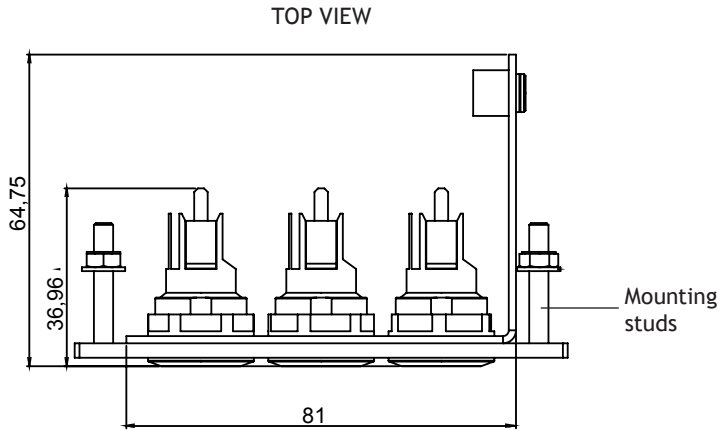
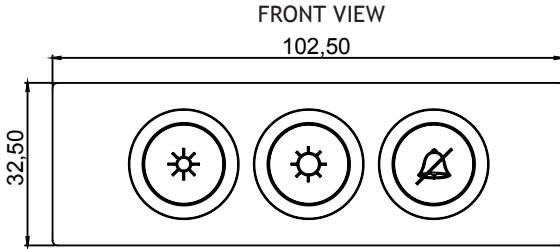

PANEL MOUNT CUTOUT

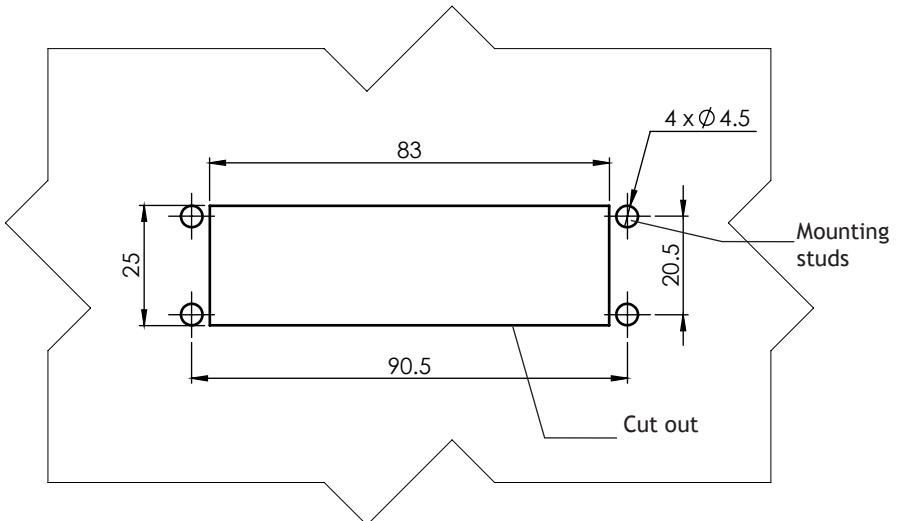

# 4

## USER CONTROLS

The remote panel is provided with a 1m cable tail for situation away from the display.

### 4.1 BUTTON FUNCTIONS





DIM



BRIGHT



ALARM MUTE

Button	Function
	<b>DIM</b> Each press will decrement the brightness level, holding the button will continue to decrement until the minimum level is reached.
	<b>BRIGHT</b> Each button will increment the brightness level, holding the Button will continue to increment until the maximum level is reached.
	<b>ALARM MUTE</b> This will mute all current active alarm conditions

- The display will power on automatically when the DC is connected to it.
- After approx 1 minute the computer will boot up into the home screen.
- Set your desired backlight brightness using the remote panel buttons.

If you require technical support for any Oceanic Systems products you can reach us using any of the following:-

- Tel: +44(0)1425 610022
- Fax: +44(0)1425 614794
- Email: [support@osukl.com](mailto:support@osukl.com)
- Web: [www.osukl.com](http://www.osukl.com)
- Post: Oceanic Systems (UK) Ltd  
Unit 10-11 Milton Business Centre  
Wick Drive, New Milton, Hampshire BH25 6RH

Oceanic Systems (UK) Ltd  
Unit 10-11 Milton Business Centre, Wick Drive,  
New Milton, Hampshire, BH25 6RH, United Kingdom

Tel: +44(0)1425 610022      Fax: +44(0)1425 614794  
Email: [sales@osukl.com](mailto:sales@osukl.com)      Web: [www.osukl.com](http://www.osukl.com)

Copyright © 2018 Oceanic Systems (UK) Ltd. All rights reserved. Our policy is one of continuous product improvement so product specifications are subject to change without notice. Oceanic Systems products are designed to be accurate and reliable. However, they should be used only as aids to vessel monitoring, and not as a replacement for traditional navigation and vessel monitoring techniques. NMEA2000® is a registered trademark of the National Marine Electronics Association.

Oceanic Systems warrants this product to be free from defects in materials and workmanship for one year from the date of original purchase. If within the applicable period any such products shall be proved to Oceanic Systems satisfaction to fail to meet the above-limited warranty, such products shall be repaired or replaced at Oceanic Systems option. Purchaser's exclusive remedy and Oceanic Systems sole obligation hereunder, provided product is returned pursuant to the return requirements below, shall be limited to the repair or replacement, at Oceanic Systems option, of any product not meeting the above limited warranty and which is returned to Oceanic Systems; or if Oceanic Systems is unable to deliver a replacement that is free from defects in materials or workmanship, Purchaser's payment for such product will be refunded. Oceanic Systems assumes no liability whatsoever for expenses of removing any defective product or part, or for installing the repaired product or part or a replacement therefore or for any loss or damage to equipment in connection with which Oceanic Systems products or parts shall be used. The foregoing warranties shall not apply with respect to products subjected to negligence, misuse, misapplication, accident, damage by circumstances beyond Oceanic Systems control, to improper installation, operation, maintenance, or storage, or to other than normal use or service.

THE FOREGOING WARRANTIES ARE EXPRESSLY IN LIEU OF AND EXCLUDES ALL OTHER EXPRESS OR IMPLIED WARRANTIES, INCLUDING BUT NOT LIMITED TO THE IMPLIED WARRANTIES OF MERCHANTABILITY AND OF FITNESS FOR A PARTICULAR PURPOSE.

Statements made by any person, including representatives of Oceanic Systems, which are inconsistent or in conflict with the terms of this Limited Warranty, shall not be binding upon Oceanic Systems unless reduced to writing and approved by an officer of Oceanic Systems.

IN NO CASE WILL OCEANIC SYSTEMS BE LIABLE FOR INCIDENTAL OR CONSEQUENTIAL DAMAGES, DAMAGES FOR LOSS OF USE, LOSS OF ANTICIPATED PROFITS OR SAVINGS, OR ANY OTHER LOSS INCURRED BECAUSE OF INTERRUPTION OF SERVICE. IN NO EVENT SHALL OCEANIC SYSTEMS AGGREGATE LIABILITY EXCEED THE PURCHASE PRICE OF THE PRODUCT(S) INVOLVED. OCEANIC SYSTEMS SHALL NOT BE SUBJECT TO ANY OTHER OBLIGATIONS OR LIABILITIES, WHETHER ARISING OUT OF BREACH OF CONTRACT OR WARRANTY, TORT (INCLUDING NEGLIGENCE), OR OTHER THEORIES OF LAW WITH RESPECT TO PRODUCTS SOLD OR SERVICES RENDERED BY OCEANIC SYSTEMS, OR ANY UNDERTAKINGS, ACTS OR OMISSIONS RELATING THERETO.

Oceanic Systems does not warrant that the functions contained in any software programs or products will meet purchaser's requirements or that the operation of the software programs or products will be uninterrupted or error free. Purchaser assumes responsibility for the selection of the software programs or products to achieve the intended results, and for the installation, use and results obtained from said programs or products. No specifications, samples, descriptions, or illustrations provided by Oceanic Systems to Purchaser, whether directly, in trade literature, brochures or other documentation shall be construed as warranties of any kind, and any failure to conform to such specifications, samples, descriptions, or illustrations shall not constitute any breach of Oceanic Systems limited warranty.

### WARRANTY RETURN PROCEDURE

To apply for warranty claims, contact Oceanic Systems or one of its dealers to describe the problem and determine the appropriate course of action. If a return is necessary, place the product in its original packaging together with proof of purchase and send to an Authorized Oceanic Systems Service Location. You are responsible for all shipping and insurance charges. Oceanic Systems will return the replaced or repaired product with all shipping and handling prepaid except for requests requiring expedited shipping (i.e. overnight shipments). Failure to follow this warranty return procedure could result in the product's warranty becoming null and void.

Oceanic Systems reserves the right to modify or replace, at its sole discretion, without prior notification, the warranty listed above.