

# T10-185

## 28" Double Locking Stow-able Pedestal Mount

Mount Weight 4.5 lb.  
(2.0 kg)

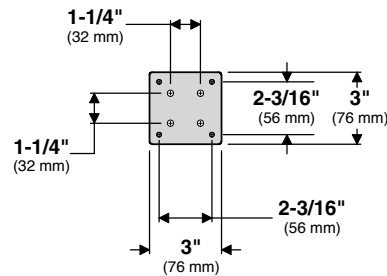
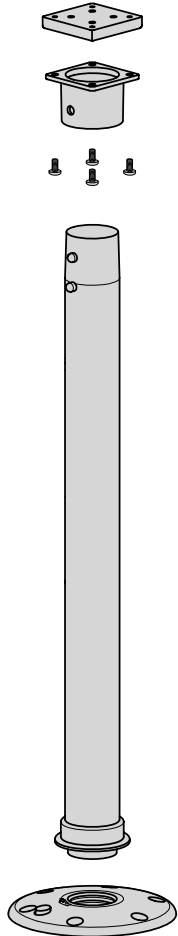

**Top View**

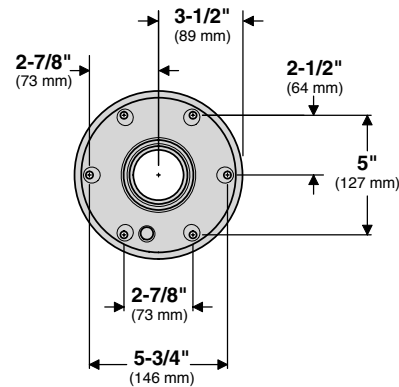

**Base  
Top View**

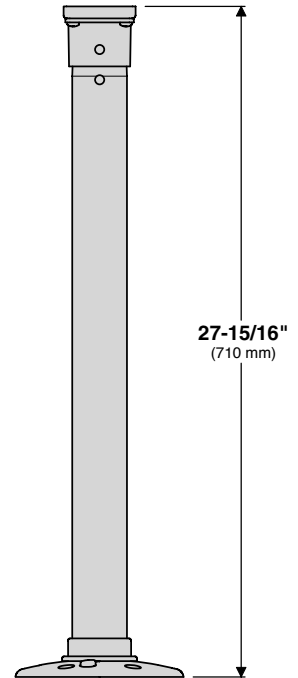
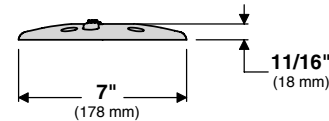
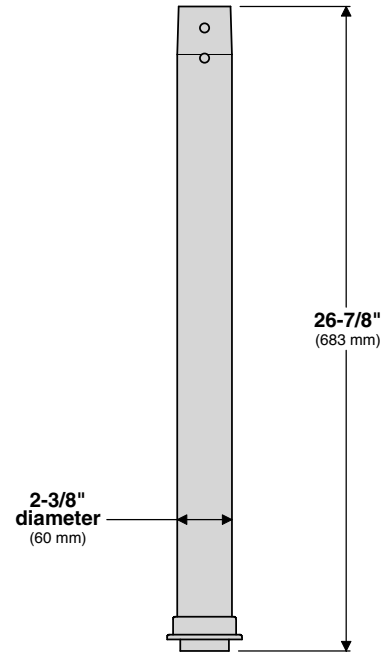
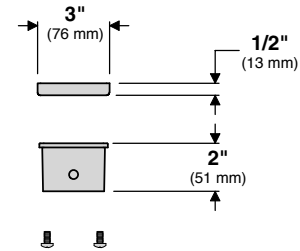

**MAGMA PRODUCTS, INC.**

3940 PIXIE AVE. • LAKEWOOD, CA 90712 • TEL (562) 627-0500 • FAX (562) 627-0550  
www.MagmaProducts.com • email: Mail@MagmaProducts.com