

PLANT VIEW
VISTA SUPERIOR

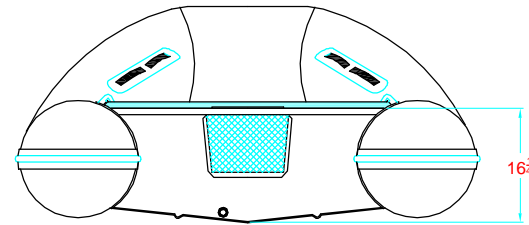

AFT VIEW
VISTA TRASERA

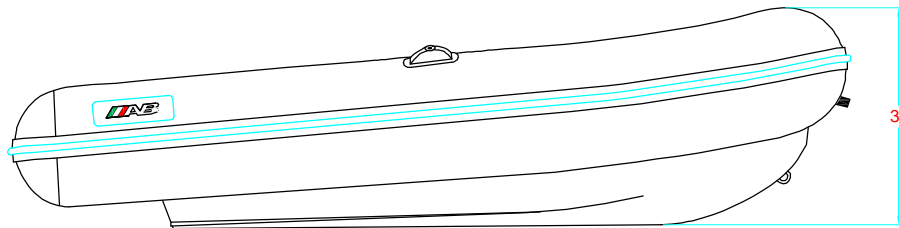

LONGITUDINAL PROFILE
VISTA LATERAL

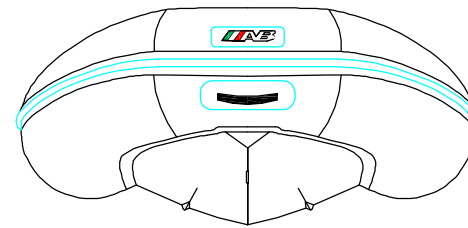

FORE VIEW
VISTA FRONTAL

MAIN PARTICULARS

MAXIMUM LENGHT/ESLORA MAX. _____ 10' (3.05m)
 MAXIMUM BEAM/MANGA MAX. _____ 5' 6" (1.68m)

NOTES: 1.-ALL DIMENSIONS IN INCHES
 TODAS LAS MEDIDAS ESTAN DADAS EN PULGADAS

SUBJECTED: ALEXANDER BARRIOS		TITLE: "ULTRA 10 UL" GENERAL ARRANGEMENT ARREGLO GENERAL						
		SCALE:	SHEET: 1/1	CODE:	PLAN:			No.REV 3
APPROVED: HERMES GARCIA		SCALE:	SHEET: 1/1	CODE:	PLAN:	No.REV 3	DATE	APPROVED:

REV. 3

ULTRA 10 UL

320 - 5 - 4

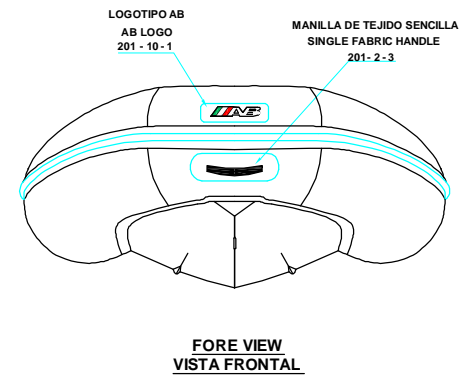
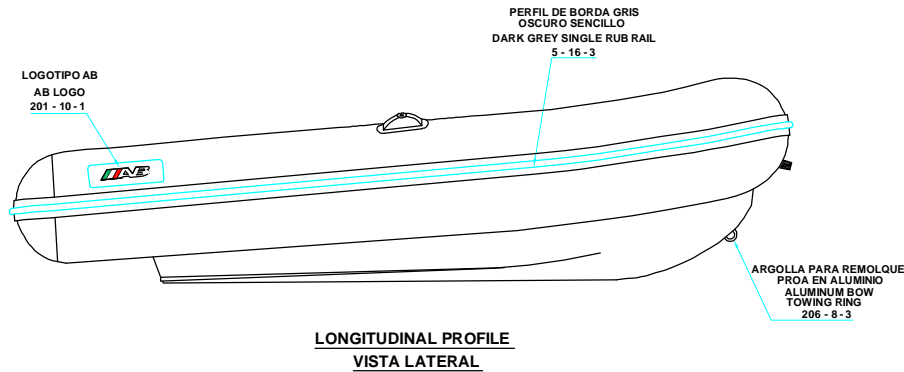
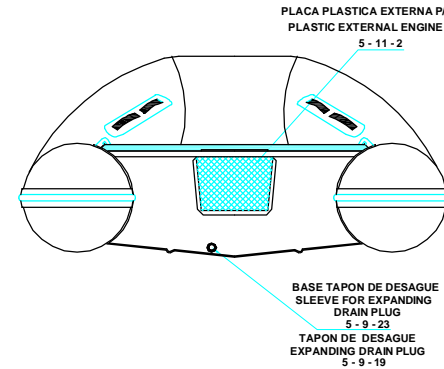
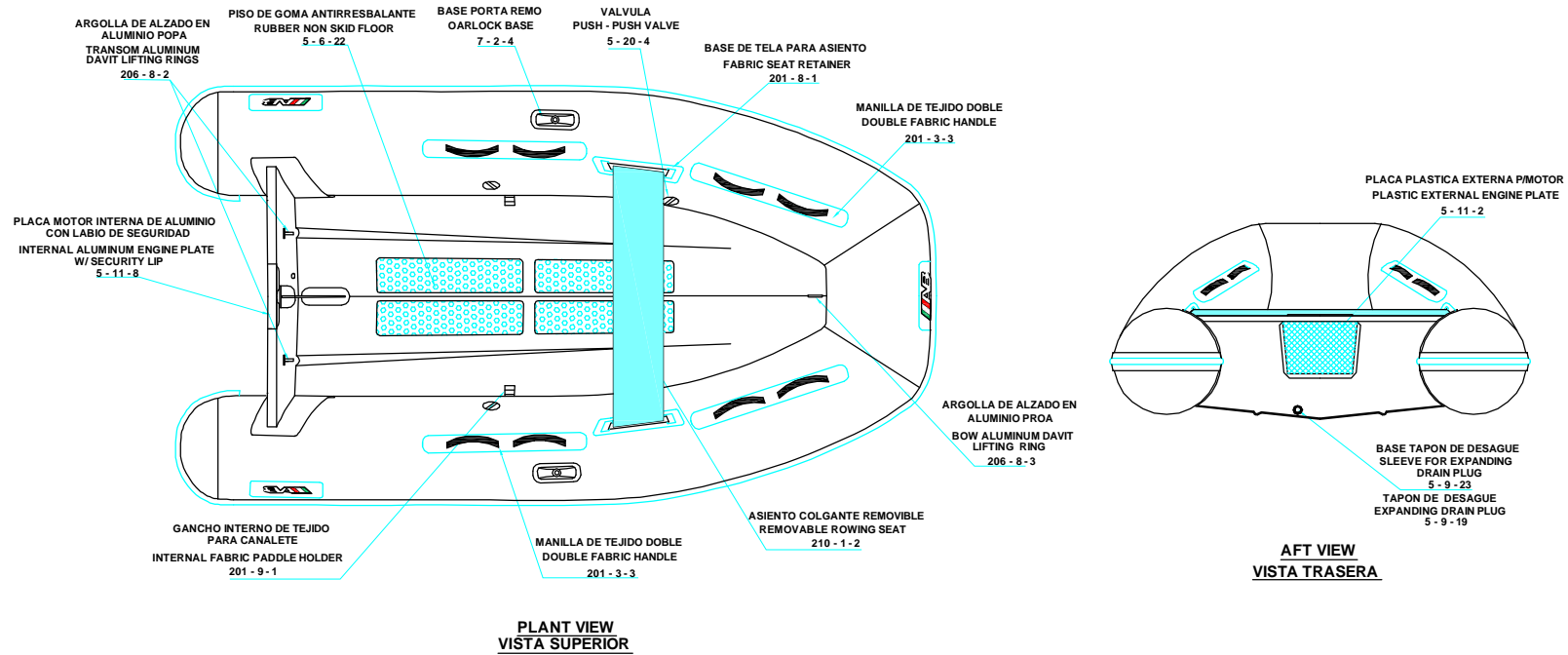

NOTA: FAVOR INDICAR COLOR DEL BOTE AL ORDENAR / **NOTE:** MUST INDICATE BOAT COLOR WHEN ORDERING

REV. 3

ULTRA 10 UL

320 - 5 - 4

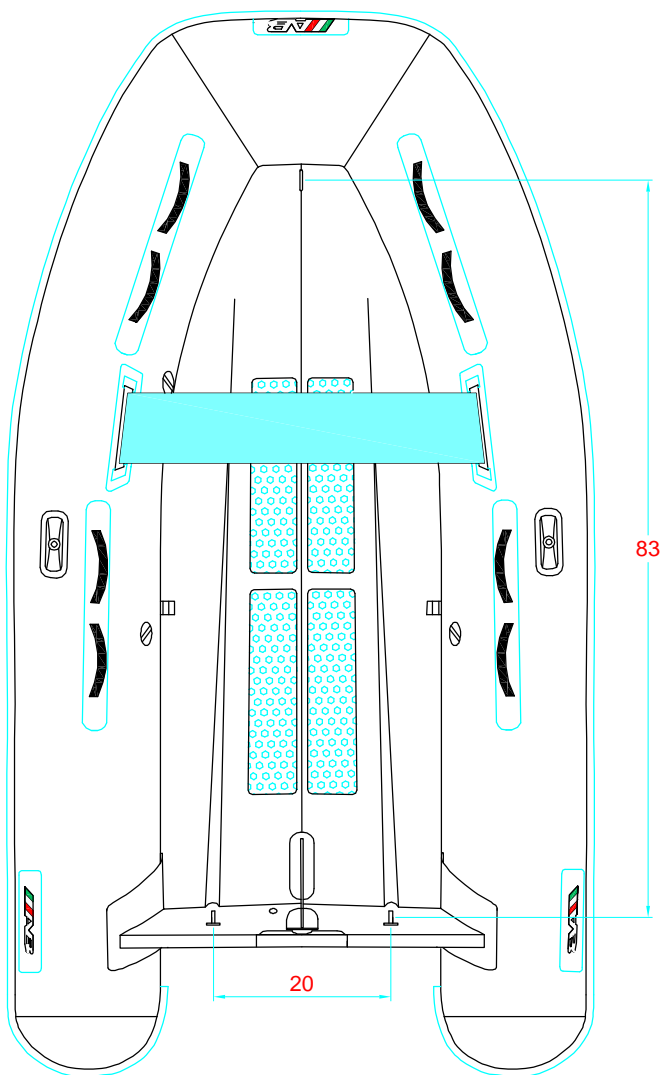

-LOCATION AND DISTANCE
OF DAVIT LIFTING POINTS
UBICACION Y DISTANCIA
DE LOS GANCHOS DE IZADO

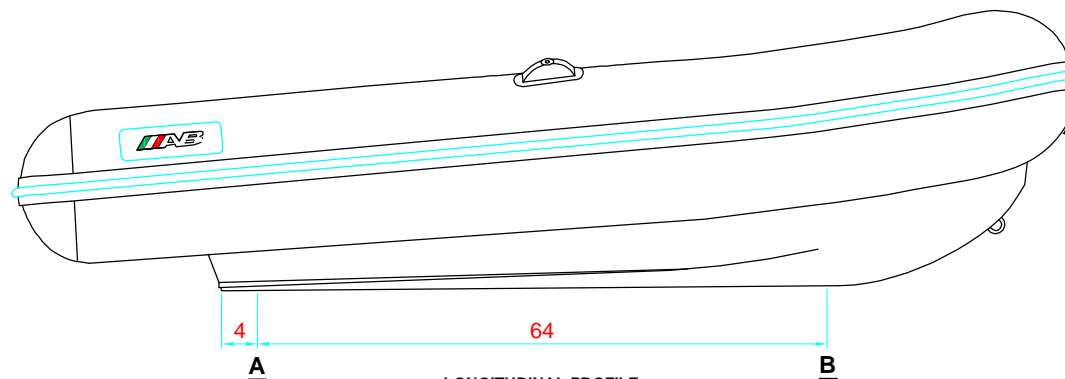

LONGITUDINAL PROFILE
VISTA LATERAL

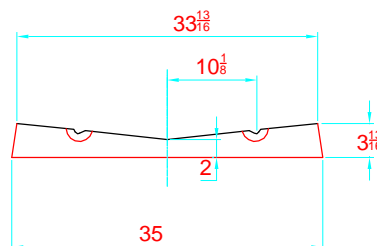

TRANSVERSAL SECTION "A"
SECCION TRANSVERSAL "A"

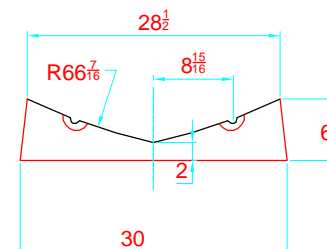

TRANSVERSAL SECTION "B"
SECCION TRANSVERSAL "B"

-RECOMMENDED CHOCK LOCATION AND BUILDING DIMENSIONS
UBICACION DE LAS CUNAS Y SUS MEDIDAS DE FABRICACION

-VERIFY MEASUREMENTS WITH ACTUAL HULL
VERIFICAR MEDIDAS DE ACUERDO A CASCO ACTUAL

NOTES: 1.- ALL DIMENSIONS IN INCHES
2.- MEASURES FROM CENTER OF CHOCK'S SURFACES