

**PLANT VIEW
VISTA SUPERIOR**

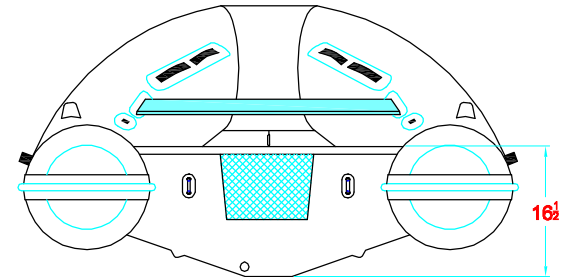

**AFT VIEW
VISTA TRASERA**

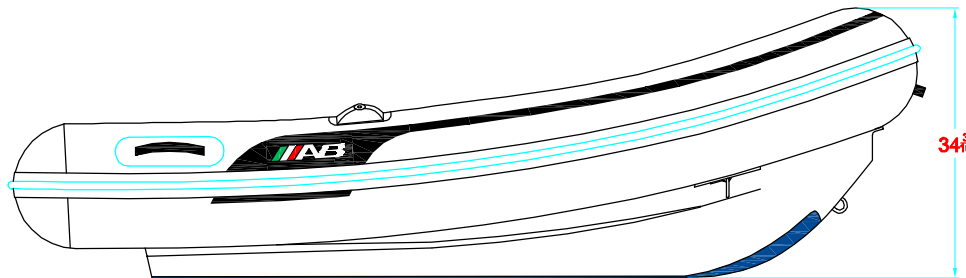

**LONGITUDINAL PROFILE
VISTA LATERAL**

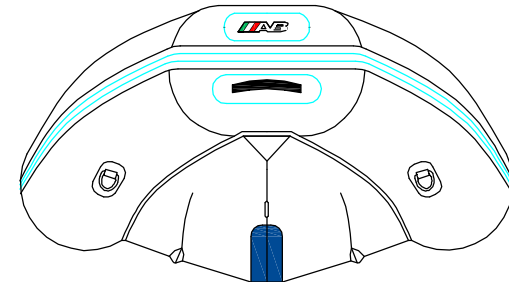

**FORE VIEW
VISTA FRONTAL**

MAIN PARTICULARS

MAXIMUM LENGHT/ESLORA MAX. _____ 9' 6" (2.90m)

MAXIMUM BEAM/MANGA MAX. _____ 5' 6" (1.68m)

NOTES: 1.-ALL DIMENSIONS IN INCHES
TODAS LAS MEDIDAS ESTAN DADAS EN PULGADAS

SUBJECTED: ALEXANDER BARRIOS APPROVED: HERMES GARCIA		TITLE: "LAMMINA 9.5 AL " GENERAL ARRANGEMENT ARREGLO GENERAL				 DATE 30.07.12 DRAWN HECTOR SUAREZ DATE _____ APPROVED: _____	
		SCALE: _____	SHEET: 1/1	CODE: _____	PLAN: ARTIGI.9.5 AL		

REV. 2

LAMMINA 9.5 AL

320 - 6 - 1

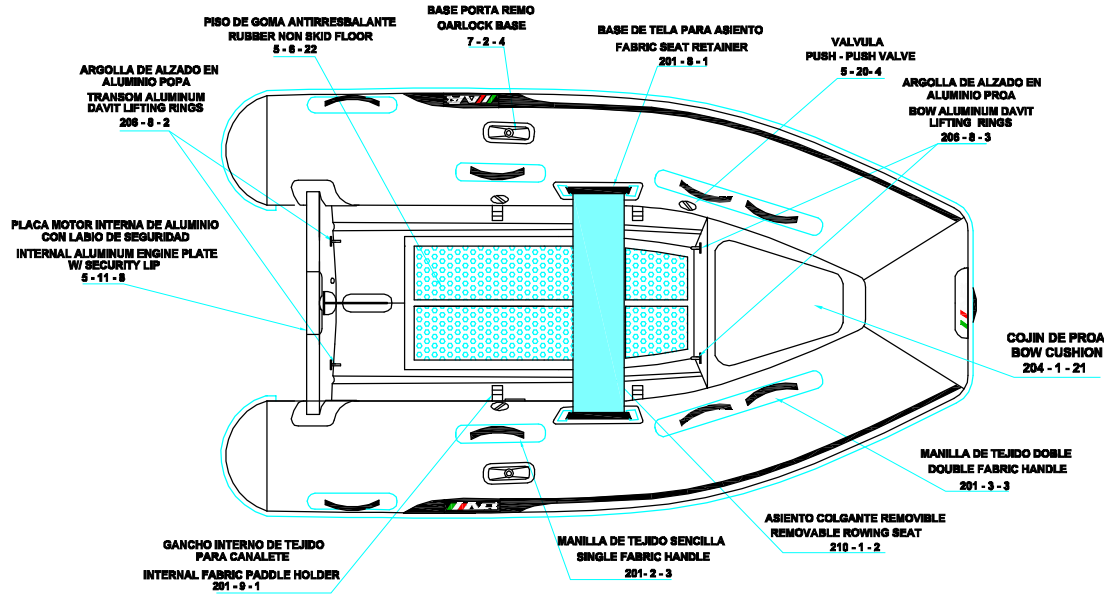

PLANT VIEW
VISTA SUPERIOR

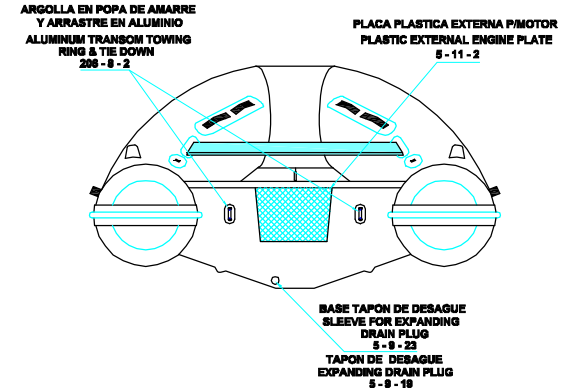

AFT VIEW
VISTA TRASERA

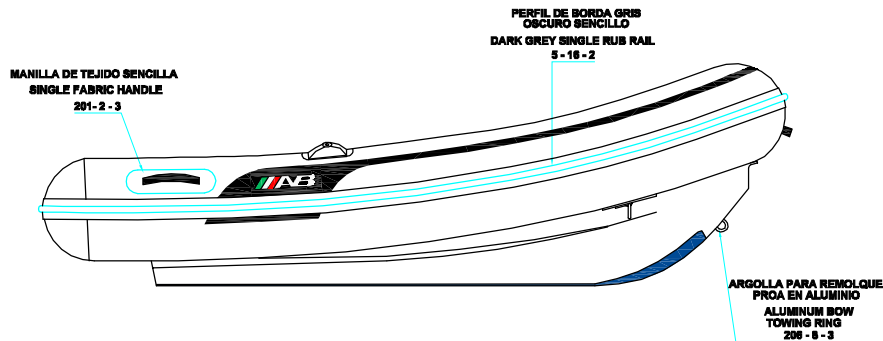

LONGITUDINAL PROFILE
VISTA LATERAL

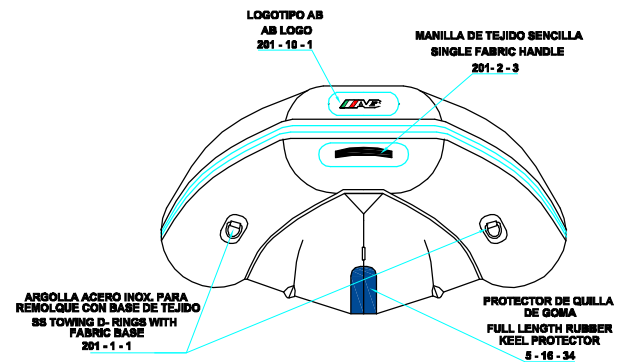

FORE VIEW
VISTA FRONTAL

NOTA: FAVOR INDICAR COLOR DEL BOTE AL ORDENAR / **NOTE:** MUST INDICATE BOAT COLOR WHEN ORDERING

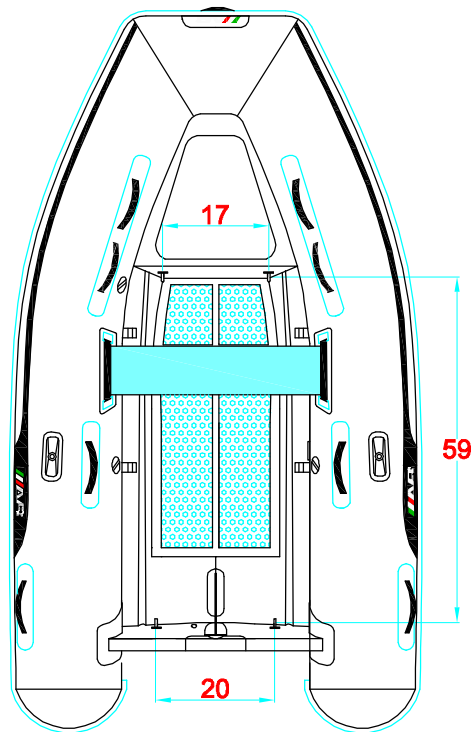

-LOCATION AND DISTANCE OF DAVIT LIFTING POINTS
 UBICACION Y DISTANCIA DE LOS GANCHOS DE IZADO

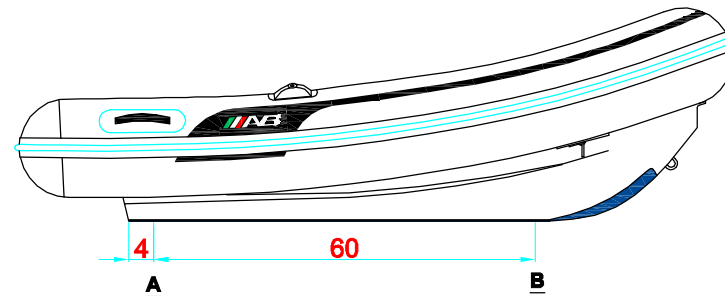

LONGITUDINAL PROFILE
PERFIL LONGITUDINAL

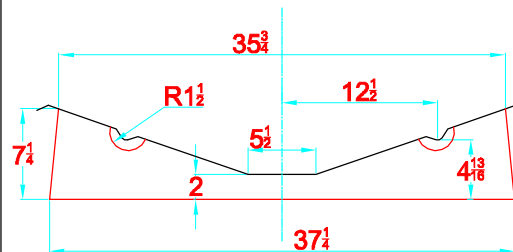

TRANSVERSAL SECTION "A"
SECCION TRANSVERSAL "A"

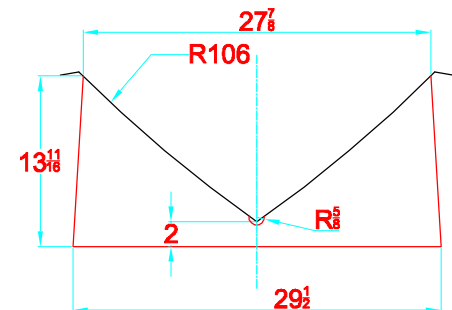

TRANSVERSAL SECTION "B"
SECCION TRANSVERSAL "B"

-RECOMMENDED CHOCK LOCATION AND BUILDING DIMENSIONS
 UBICACION DE LAS CUNAS Y SUS MEDIDAS DE FABRICACION

-VERIFY MEASUREMENTS WITH ACTUAL HULL
 VERIFICAR MEDIDAS DE ACUERDO A CASCO ACTUAL

NOTES: 1.- ALL DIMENSIONS IN INCHES
 2.- MEASURES FROM CENTER OF CHOCK'S SURFACES